



MAL

4417

HARVARD UNIVERSITY



Library of the  
Museum of  
Comparative Zoology









---

# MALACOLOGIA

---

International Journal of Malacology

Revista Internacional de Malacologia

Journal International de Malacologie

Международный Журнал Малакологии

Internationale Malakologische Zeitschrift

# MALACOLOGIA

Publication dates

Vol. 19, No. 2—14 April 1980

Vol. 20, No. 1—22 August 1980

International Journal of Malacology

Revue Internationale de Malacologie

Journal International de Malacologie

Malacologia Internationalis

International Malacological Society



## MALACOLOGIA, VOL. 20

## CONTENTS

K. J. BOSS and R. D. TURNER The giant white clam from the Galapagos Rift, <i>Calyptogena magna</i> <i>nifica</i> species novum .....	161
M. R. CARRIKER Shell penetration and feeding by naticacean and muricacean gas- tropods: a synthesis .....	403
S. M. CHAMBERS Genetic divergence between populations of <i>Goniobasis</i> (Pleuro- ceridae) occupying different drainage systems .....	63
N. COLEMAN and W. CUFF The abundance, distribution and diversity of the molluscs of Western Port, Victoria, Australia .....	35
G. M. DAVIS and S. L. H. FULLER Genetic relationships among Recent Unionacea (Bivalvia) of North America .....	217
R. T. DILLON, Jr. and G. M. DAVIS The <i>Goniobasis</i> of southern Virginia and northwestern North Carolina: genetic and shell morphometric relationships .....	83
G. A. HESLINGA Larval development, settlement and metamorphosis of the tropical gastropod <i>Trochus niloticus</i> .....	349
R. S. HOUBRICK Observations on the anatomy and life history of <i>Modulus modulus</i> (Prosobranchia: Modulidae) .....	117
R. N. HUGHES and H. P. I. HUGHES Morphological and behavioural aspects of feeding in the Cassidae (Tonnacea, Mesogastropoda) .....	385
A. J. KOHN Feeding mechanisms of predatory molluscs: introduction to the symposium .....	359
L. R. KRAEMER The osphradial complex of two freshwater bivalves: histological evaluation and functional context .....	205
M. LAZARIDOU-DIMITRIADOU et J. DAGUZAN Etude de l'effet du "groupement" des individus chez <i>Theba pisana</i> (Mollusque Gastéropode Stylommatophore) .....	195
D. R. LINDBERG Rhodopetalinae, a new subfamily of Acmaeidae from the boreal Pacific: anatomy and systematics .....	291
R. M. LINSLEY and M. JAVIDPOUR Episodic growth in Gastropoda .....	153
J. NYBAKKEN and G. McDONALD Feeding mechanisms of West American nudibranchs feeding on Bryozoa, Cnidaria and Ascidiacea, with special respect to the radula .....	439
E. J. PETUCH A relict Neogene caenogastropod fauna from northern South America .....	307

# MALACOLOGIA

## CONTENTS (cont.)

- R. S. PREZANT  
The arenophilic radial mantle glands of the Lyonsiidae (Bivalvia: Anomalodesmata) with notes on lyonsiid evolution ..... 267
- W. D. RUSSELL-HUNTER, A. J. BURKY and R. D. HUNTER  
Interpopulation variation in calcareous and proteinaceous shell components in the stream limpet, *Ferrissia rivularis* ..... 255
- A. H. SCHELTEMA  
Comparative morphology of the radulae and alimentary tracts in the Aplacophora ..... 361
- R. L. SHIMEK and A. J. KOHN  
Functional morphology and evolution of the toxoglossan radula ..... 423
- R. J. STANTON, Jr., E. N. POWELL and P. C. NELSON  
The role of carnivorous gastropods in the trophic analysis of a fossil community ..... 451
- F. G. THOMPSON  
Proserpinoid land snails and their relationships within the Archaeogastropoda ..... 1
- L. G. WILLIAMS  
Development and feeding of larvae of the nudibranch gastropods *Hermisenda crassicornis* and *Aeolidia papillosa* ..... 99
- C. M. YONGE  
On *Patro australis* with comparisons of structure throughout the Anomiidae (Bivalvia) ..... 143





WHY NOT SUBSCRIBE TO MALACOLOGIA?

ORDER FORM

Your name and address \_\_\_\_\_  
\_\_\_\_\_  
\_\_\_\_\_

Send U.S. \$17.00 for a personal subscription (one volume) or U.S. \$27.00 for an institutional subscription. Make checks payable to "MALACOLOGIA."

Address: Malacologia, Academy of Natural Sciences  
Nineteenth and the Parkway, Philadelphia  
PA 19103, U.S.A.

## INSTRUCTIONS FOR AUTHORS

MALACOLOGIA publishes original studies on the Mollusca that are of international interest and are of high scholarly standards. Both descriptive and experimental research results are acceptable provided they are primarily or exclusively concerned with the phylum. Contributions include long monographs as well as moderately short research papers. Brief papers are not acceptable. MALACOLOGIA provides a forum for such different aspects of malacology as anatomy, comparative physiology, ecology, medical malacology, paleontology and systematics. Papers of only biochemical or physiological interest should be submitted elsewhere. Review articles are more appropriately submitted to *Malacological Review* (P.O. Box 801, Whitmore Lake, Michigan 48189, U.S.A.). All manuscripts submitted are reviewed by at least 2 malacologists. Articles are accepted with the firm understanding that they have not been submitted or published elsewhere in whole or in part.

**Manuscripts** may be in English, French, German or Spanish, and should follow MALACOLOGIA style. They must contain a concise but informative Abstract summarizing not only the content but the results. Papers in languages other than English should include a translation of the Abstract into English. Authors desiring their abstracts translated into other languages must provide these. Care should be taken to include all necessary foreign accents. Manuscripts must be typed on one side of good quality white paper, double-spaced throughout, with ample margins, and are to be submitted in triplicate. Illustrations are likewise to be in triplicate (the 2 copies may be photocopies, etc.). Tables, figure captions and all footnotes are to be grouped (in this order) at the end of a manuscript, and all Ms pages (including the Abstract) are to be numbered sequentially. Avoid internal page references (which have to be added in page proof). Make the hierarchy of headings within the text simple and consistent. Suggest an abbreviated running title to be used at the top of each right hand page.

Contributors in English are asked to use the *Council of Biology Editors (CBE) Style Manual* (Ed. 3, 1972), obtainable for \$6.00 from the American Institute of Biological Sciences,

1401 Wilson Boulevard, Arlington, Virginia 22209, U.S.A. MALACOLOGIA follows most of the recommendations in this *Manual*. In particular, simplified particles such as the following are used: numbers above ten should not be written out except at the beginning of a sentence; percentages following a number are expressed as %, and abbreviations of measures (after a number): mm, ml, kg, etc. have no period (full stop), nor an "s" in the plural. Note that the international symbol for micron is now  $\mu\text{m}$ , not  $\mu$ .

**Illustrations** must be carefully prepared and so planned that they can be printed in 1 column or the full width of a page of the journal. The maximum size of a printed figure is  $13.5 \times 20.0$  cm (preferably not as high as this so that the caption does not have to be on the opposite page). Drawings and lettering must be in dark black on white, blue tracing, or blue-lined paper. Lines and dots should be thick enough to allow reduction by  $\frac{1}{2}$  or  $\frac{1}{3}$ . This should be taken into consideration also in relation to the lettering. Letters and numbers must not be less than 2 mm in height, preferably larger, after reduction. Several drawings or photographs may be grouped together to fit a page, but drawings are not to be grouped with photographs. Photographs are to be glossy and high contrast. All illustrations are to be numbered sequentially as figures (not grouped as plates), and are to be arranged as closely as possible to the order in which they are first cited in the text (Each figure must be cited in the text.) All original illustrations should be mounted, numbered, labeled or lettered and ready for the engraver. Scale lines are required for all figures and should be convenient lengths (e.g., "200  $\mu\text{m}$ ," not "163  $\mu\text{m}$ "). Magnifications in captions are not acceptable, and neither are photographic reductions of line drawings.

**Captions** should summarize what is shown in an illustration, and should not duplicate additional information given in the text. Each lettered abbreviation labeling an individual feature in a figure must either be explained in each caption (listed alphabetically), or be grouped in one alphabetic sequence in a section near the beginning of the text (use the latter method if many abbreviations are repeated on different figures).

**Tables** are to be used sparingly, and should be planned to fit 1 or 2 columns on 1

N. M. 3322

MUS. COMP. Zool.  
LIBRARY

VOL. 20 NO. 1

AUG 27 1980

1980

HARVARD  
UNIVERSITY

---

# MALACOLOGIA

---

International Journal of Malacology

Revista Internacional de Malacologia

Journal International de Malacologie

Международный Журнал Малакологии

Internationale Malakologische Zeitschrift

# MALACOLOGIA

*Editors-in-Chief:*

GEORGE M. DAVIS

ROBERT ROBERTSON

*Editorial and Subscription Offices:*

Department of Malacology  
The Academy of Natural Sciences of Philadelphia  
Nineteenth Street and the Parkway  
Philadelphia, Pennsylvania 19103, U.S.A.

*Associate Editors:*

JOHN B. BURCH  
University of Michigan, Ann Arbor

ANNE GISMANN  
Maadi, A. R. Egypt

*Editorial Assistant:*

MARY DUNN

MALACOLOGIA is published by the INSTITUTE OF MALACOLOGY (2415 South Circle Drive, Ann Arbor, Michigan 48103, U.S.A.), the Sponsor Members of which (also serving as editors) are:

J FRANCES ALLEN, *Emerita*  
Environmental Protection Agency  
Washington, D.C.

CHRISTOPHER J. BAYNE, *President-Elect*  
Oregon State University, Corvallis

ELMER G. BERRY, *Emeritus*  
Germantown, Maryland

KENNETH J. BOSS  
Museum of Comparative Zoölogy  
Cambridge, Massachusetts

JOHN B. BURCH

MELBOURNE R. CARRIKER  
University of Delaware, Lewes

GEORGE M. DAVIS, *Executive  
Secretary-Treasurer*

ROBERT ROBERTSON

CLYDE F. E. ROPER, *President*  
Smithsonian Institution  
Washington, D.C.

W. D. RUSSELL-HUNTER  
Syracuse University, New York

NORMAN F. SOHL  
United States Geological Survey  
Washington, D.C.

RUTH D. TURNER, *Alternate*  
Museum of Comparative Zoölogy  
Cambridge, Massachusetts

SHI-KUEI WU, *Vice-President*  
University of Colorado Museum, Boulder

Institute meetings are held the first Friday in December each year at a convenient place. For information, address the President.



## EDITORIAL BOARD

- J. A. ALLEN  
*Marine Biological Station,  
Millport, United Kingdom*
- E. E. BINDER  
*Muséum d'Histoire Naturelle  
Genève, Switzerland*
- A. H. CLARKE, Jr.  
*National Museum of Natural History  
Washington, D.C., U.S.A.*
- E. S. DEMIAN  
*Ain Shams University  
Cairo, A. R. Egypt*
- C. J. DUNCAN  
*University of Liverpool  
United Kingdom*
- Z. A. FILATOVA  
*Institute of Oceanology  
Moscow, U.S.S.R.*
- E. FISCHER-PIETTE  
*Muséum National d'Histoire Naturelle  
Paris, France*
- V. FRETTER  
*University of Reading  
United Kingdom*
- E. GITTENBERGER  
*Rijksmuseum van Natuurlijke Historie  
Leiden, Netherlands*
- A. N. GOLIKOV  
*Zoological Institute  
Leningrad, U.S.S.R.*
- A. V. GROSSU  
*Universitatea Bucuresti  
Romania*
- T. HABE  
*National Science Museum  
Tokyo, Japan*
- A. D. HARRISON  
*University of Waterloo  
Ontario, Canada*
- K. HATAI  
*Tohoku University  
Sendai, Japan*
- B. HUBENDICK  
*Naturhistoriska Museet  
Göteborg, Sweden*
- A. M. KEEN  
*Stanford University  
California, U.S.A.*
- R. N. KILBURN  
*Natal Museum  
Pietermaritzburg, South Africa*
- M. A. KLAPPENBACH  
*Museo Nacional de Historia Natural  
Montevideo, Uruguay*
- J. KNUDSEN  
*Zoologisk Institut & Museum  
København, Denmark*
- A. J. KOHN  
*University of Washington  
Seattle, U.S.A.*
- Y. KONDO  
*Bernice P. Bishop Museum  
Honolulu, Hawaii, U.S.A.*
- C. M. LALLI  
*McGill University  
Montreal, Canada*
- J. LEVER  
*Amsterdam, Netherlands*
- A. LUCAS  
*Faculté des Sciences  
Brest, France*
- N. MACAROVICI  
*Universitatea "Al. I. Cuza"  
Iasi, Romania*
- C. MEIER-BROOK  
*Tropenmedizinisches Institut  
Tübingen, Germany (Federal Republic)*
- H. K. MIENIS  
*Hebrew University of Jerusalem  
Israel*
- J. E. MORTON  
*The University  
Auckland, New Zealand*
- R. NATARAJAN  
*Marine Biological Station  
Porto Novo, India*
- J. ØKLAND  
*University of Oslo  
Norway*

T. OKUTANI  
*National Science Museum  
Tokyo, Japan*

W. L. PARAENSE  
*Universidade de Brasilia  
Brazil*

J. J. PARODIZ  
*Carnegie Museum  
Pittsburgh, U.S.A.*

C. M. PATTERSON  
*University of Michigan  
Ann Arbor, U.S.A.*

W. F. PONDER  
*Australian Museum  
Sydney*

A. W. B. POWELL  
*Auckland Institute & Museum  
New Zealand*

R. D. PURCHON  
*Chelsea College of Science & Technology  
London, United Kingdom*

O. RAVERA  
*Euratom  
Ispra, Italy*

N. W. RUNHAM  
*University College of North Wales  
Bangor, United Kingdom*

S. G. SEGERSTRÅLE  
*Institute of Marine Research  
Helsinki, Finland*

G. A. SOLEM  
*Field Museum of Natural History  
Chicago, U.S.A.*

F. STARMÜHLNER  
*Zoologisches Institut der Universität  
Wien, Austria*

Y. I. STAROBOGATOV  
*Zoological Institute  
Leningrad, U.S.S.R.*

W. STREIFF  
*Université de Caen  
France*

J. STUARDO  
*Universidad de Chile,  
Valparaiso*

T. E. THOMPSON  
*University of Bristol  
United Kingdom*

F. TOFFOLETTO  
*Società Malacologica Italiana  
Milano*

W. S. S. VAN BENTHEM JUTTING  
*Domburg, Netherlands*

J. A. VAN EEDEN  
*Potchefstroom University  
South Africa*

J.-J. VAN MOL  
*Université Libre de Bruxelles  
Belgium*

N.H. VERDONK  
*Rijksuniversiteit  
Utrecht, Netherlands*

B. R. WILSON  
*National Museum of Victoria  
Melbourne, Australia*

C. M. YONGE  
*Edinburgh, United Kingdom*

H. ZEISSLER  
*Leipzig, Germany (Democratic Republic)*

A. ZILCH  
*Natur-Museum und Forschungs-Institut  
Senckenberg  
Frankfurt-am-Main, Germany (Federal  
Republic)*

## PROSERPINOID LAND SNAILS AND THEIR RELATIONSHIPS WITHIN THE ARCHAEOGASTROPODA

Fred G. Thompson

*Florida State Museum, University of Florida, Gainesville, Florida 32611, U.S.A.*

### ABSTRACT

The classification of the proserpinoid land snails is reviewed. Two families are recognized, Proserpinidae and Ceresidae new family. The Proserpinidae are confined to the West Indies and include a single genus with eight extant species. The Ceresidae are currently known from Mexico and South America and contain five genera and thirteen species. The Ceresidae are a family of terrestrial diotocardian Archaeogastropoda that have two functional auricles, are holopod, lack an operculum and have a lamella barrier within the aperture. The Proserpinidae are more specialized, with a single auricle and an aulacopod foot, but also lack an operculum and have an internal barrier.

On the basis of morphological data two families of prosobranch snails can be derived from the Ceresidae: the Proserpinidae and the Helicinidae. The Helicinidae have a single auricle, a holopod foot, an operculum, and lack a lamellar barrier. The operculum is a derived structure that more effectively closes the aperture to intruding objects than does the lamellar barrier in the ancestral groups. The relationship between the Ceresidae and the Helicinidae is clear on the basis of known anatomical data. The relationship between the Proserpinidae and the Helicinidae is less clear. The Proserpinidae and the helicinid subfamily Vianinae have similar radulae which are divergent from the basic type that occurs in other Helicinidae and the Ceresidae. Other anatomical characteristics of the Vianinae are typically helicinid. Probably the similar radulae of the Proserpinidae and the Vianinae are due to convergent evolution for similar trophic activities and do not reflect a close relationship between the two groups.

The families Ceresidae, Proserpinidae and Helicinidae comprise the new superfamily Helicinacea. The Hydrocenidae, which frequently are placed in close association with the Helicinidae, are herein placed in a separate superfamily, Hydrocenacea.

The Helicinacea is postulated to have evolved from a primitive marine diotocardian ancestor, but not from the Neritacea.

### INTRODUCTION

The classification of proserpinoid land snails into family and subfamily units has satisfied few malacologists who have worked with them. The first species to be described were thought to be pulmonate land snails because of the lack of an operculum and the presence of a lamellar barrier within the aperture, broadly similar to the lamellar barrier that occurs in several families of pulmonate land snails. Gray (1856) and Bland (1863) established the relationship of proserpinoids to the prosobranch Helicinidae. Baker (1922, 1926b) and Thiele (1931) gave additional data on the radula, and affirmed the relationship of the proserpinoids to the Helicinidae.

Only a single review of the proserpinoids has been published within the last century. Boss & Jacobson monographed the West Indian species (1975a) and gave an overview on the classification of mainland taxa (1975b).

They treat the group as a subfamily, Proserpininae, of the Helicinidae and recognize two genera, *Ceres*, confined to Mexico, and *Proserpina*, including all other mainland and West Indian species. Other authors (Thiele, 1931: 89-91; Wenz, 1940: 447-448; Keen, 1960: 1287-1288) gave various schemes of generic classification but did not treat the species.

The recent discovery by the author of two new species of *Proserpina* in Hispaniola has led to the anatomical examinations of two species and a more critical examination of the shells of other described mainland species. These studies necessitate a reevaluation of proserpinoid classification. Although the anatomical information is, unfortunately, limited to two species, enough data on the anatomy of the Helicinidae are available to give substantial weight to the anatomical criteria used for classification in this paper. This paper consists of three sections. The first presents ana-

tomical data on some species. The second section deals with the phylogeny of the proserpinids and related families. The third section deals with taxonomic observations on proserpinoids and a synopsis of the species.

## MATERIALS AND METHODS

The anatomical information presented below is based upon two species, *Ceres nelsoni* Dall and *Proserpina nitida* Sowerby. Also included are published observations on the radula of *Ceres salleana* Gray, *Linidiella swifti* (Bland), and *Proserpina (Despoenella) depressa* (Orbigny). Specimens of *Ceres nelsoni* were collected at various localities in wet forests over limestone substrates in San Luis Potosí, Mexico (see *Distribution* under *C. nelsoni*). Most (UF<sup>1</sup> 24405, UF 24406) were collected by James Reddell, Texas Tech University, while he conducted speleological studies. These specimens were dropped live into 70% isopropanol. One male (UF 24091a) was collected by the author. It was narcotized in water with menthol crystals, killed in Bouin's fixative, and preserved in 70% isopropanol. Forty-three specimens of *Proserpina nitida* were studied. These were collected by Glenn Goodfriend at 1.3 mi S. Clarmont, St. Ann Parish, Jamaica, on 1 November 1976 at night. These were drowned in water and preserved in 70% isopropanol.

**Methods:** Dissections were made under 70% isopropanol. The mantle collar and mantle were removed dorsally to reveal the internal arrangement of the pallial organs, the pallial gonoduct, and the lower intestine. Next, the reproductive system was teased free from other organs and removed. Then the dorsal body wall over the head and nape was opened to reveal the central nervous system and the anterior digestive system. Radulae were cleaned in 1% KOH. Radulae for photomicroscopic study were stained with 10% Harris's Haematoxylin. Radulae were also studied with a Cambridge Mark II scanning electron microscope. Reproductive systems were serial sectioned at 10  $\mu\text{m}$  and stained with 10% Harris's Haematoxylin.

The nervous systems of *Ceres* and *Proserpina* do not differ from those of the Helicinidae. Thus they are not described in the anatomical section, but are discussed later.

**Terminology:** The Helicinacea differ from

other Prosobranchia in the structure of the posterior portion of the pallial gonoduct and adjacent organs, for which special terminology has been used (Thiele, 1902; Bourne, 1911; Baker, 1925, 1926a).

**V-organ:** A peculiar topological configuration formed by the lower end of the primary oviduct and the adjacent portion of the pallial oviduct, which combine to form a thick-walled V-shaped structure. The pallial portion is called the *pedicel*.

**Accessory sperm sac:** A small bulb (seminal receptacle II?) on the pedicel. Baker (1925) stated that it probably is homologous with the common reno-pericardial-gonadic duct of ancestral gastropods.

**Provaginal sac:** A thin-walled sac on the side of the vagina just above the vaginal opening, and is derived from the vestigial right kidney of ancestral rhipidoglossans (Thiele, 1902; Baker, 1925).

**Reception chamber:** A voluminous chamber lying between and connecting the pedicel, the pallial oviduct, and the vagina; term *seminal receptacle* is used in this paper to comply with other prosobranch terminology; however, the bursa copulatrix, provaginal sac, reception chamber, and accessory sperm sac all receive spermatozoa, so the function of the reception chamber is not unique as a receptacle (Baker, 1925, 1926a).

**Hypobranchial duct:** Generally a thin-walled duct leading from the hypobranchial gland into the mantle cavity; in the Helicinidae the vagina opens inside the duct, thus incorporating the structure into the reproductive system. Bourne (1911) and Baker (1925, 1926a), described the histology of the gland and duct.

**Ureter:** Equivalent to *renal papilla* in other Prosobranchia, and not ureter as occurs in the Pulmonata. Renal papilla is used in this paper.

**Aulacopod-holopod foot:** The side of the foot in the Proserpinidae is circumscribed by a continuous groove originating from the anterior mucous groove and demarcating a narrow band of tissue bordering the sole. This groove is similar to the aulacopod foot of some Pulmonata. The holopod foot refers to the absence of such a demarcating groove. These terms are used as adjectives in this paper and no homology with the Pulmonata is implied.

<sup>1</sup>Florida State Museum, University of Florida.

ANATOMY OF CERES AND PROSERPINA

*Ceres nelsoni* Dall

The following observations are based upon twelve preserved specimens. All illustrations are based upon specimens from UF 24405 (see species account for data).

**External anatomy:** Foot holopod, moderately long, broadly spatulate; broadly triangulate in cross-section posteriorly, and bearing long dorsal keel; caudal pore absent. Sole undivided longitudinally. Snout projecting beyond it anteriorly; deep anterior mucous groove along anterior margin of foot extending posteriorly on each side for distance about equal to half the width of sole; sides of foot and snout diffusely mottled with black. Tentacles long, slender and black with black bar connecting them across nape. Eyes on outer side of tentacles just above their base. Mantle collar white with diffuse gray along anterior edge. Collar completely surrounding body and bearing narrow, free lappet that is confined dorsally within shell; ventrally the lappet expands posteriorly to form thin pad upon which shell

rests. Respiration facilitated by open mantle cavity which effectively forms a lung. Mantle unpigmented except for a few diffuse patches of gray over the pallial genitalia and lower half of hypobranchial gland. A very short columellar cleft extends posteriorly to point just behind mantle collar (Fig. 4). Right columellar retractor muscle broad, triangular, and attached to shell at posterior end of cleft. Left columellar retractor similar but about half as large. Roof of mantle cavity heavily supplied with large transversely alternating arteries and veins. Blood vessels most abundant posteriorly and in mid-region, sparse and smaller just behind mantle collar. Genitalia and rectum terminate just behind mantle collar.

Hypobranchial gland (Figs. 4, 12) very large, extending along dorsal (right) side of mantle wall from posterior edge of renal cavity to about middle of pallial genitalia. Hypobranchial duct (Fig. 12) lying between columellar angle of mantle cavity and lower genitalia, open along anterior mesad half which is densely lined internally with large conical papillae.

**Pallial complex:** Pericardium a large sac

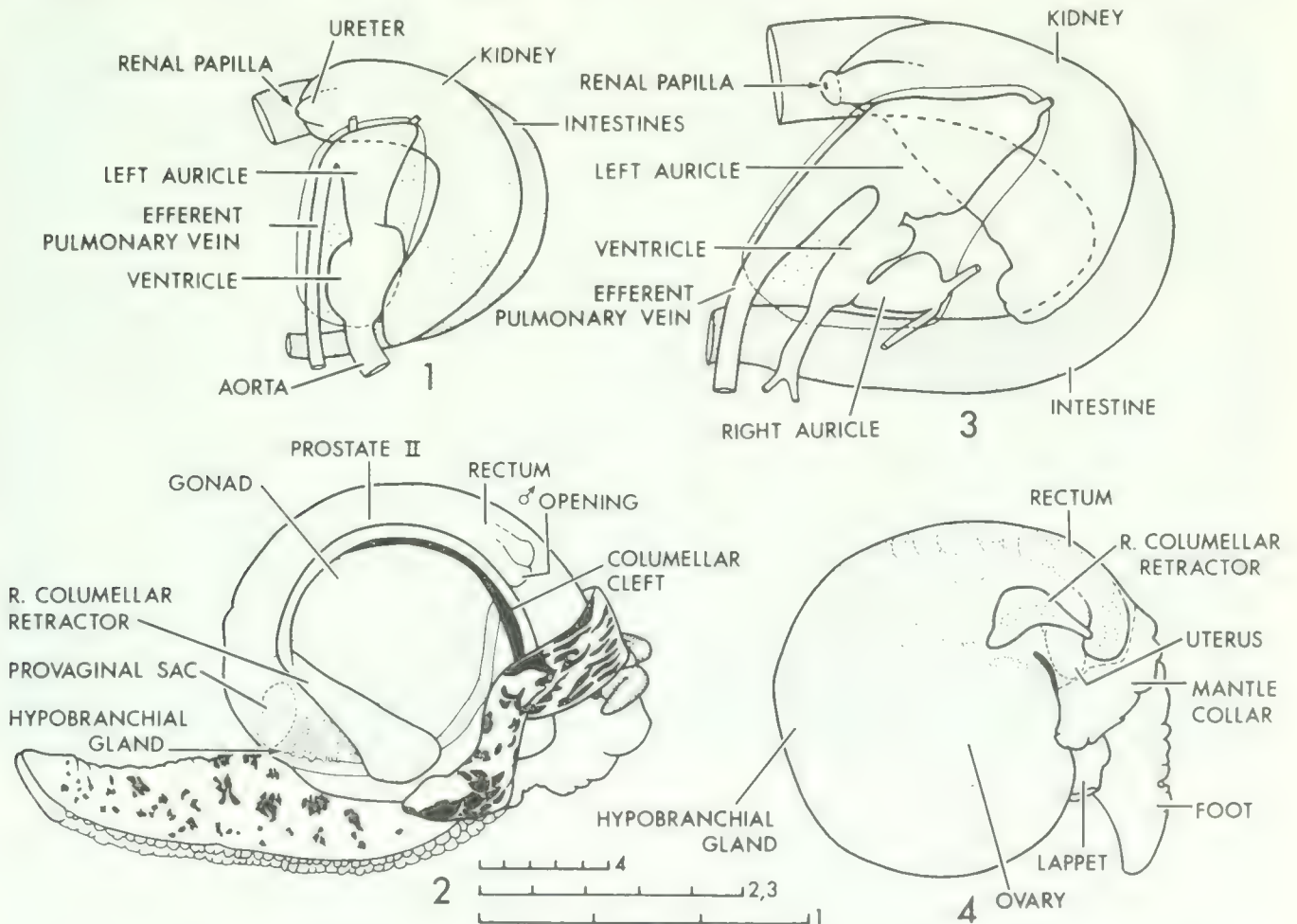

FIGS. 1-4. Soft anatomy of *Proserpina* and *Ceres*. Fig. 1. *Proserpina nitida* Sby.—ventral view of pallial organs. Fig. 2. *P. nitida*—dorsal view of female with shell removed. Fig. 3. *Ceres nelsoni* Dall—inner view of pallial organs. Fig. 4. *C. nelsoni*—dorsal view of female with shell removed. Scales in mm.

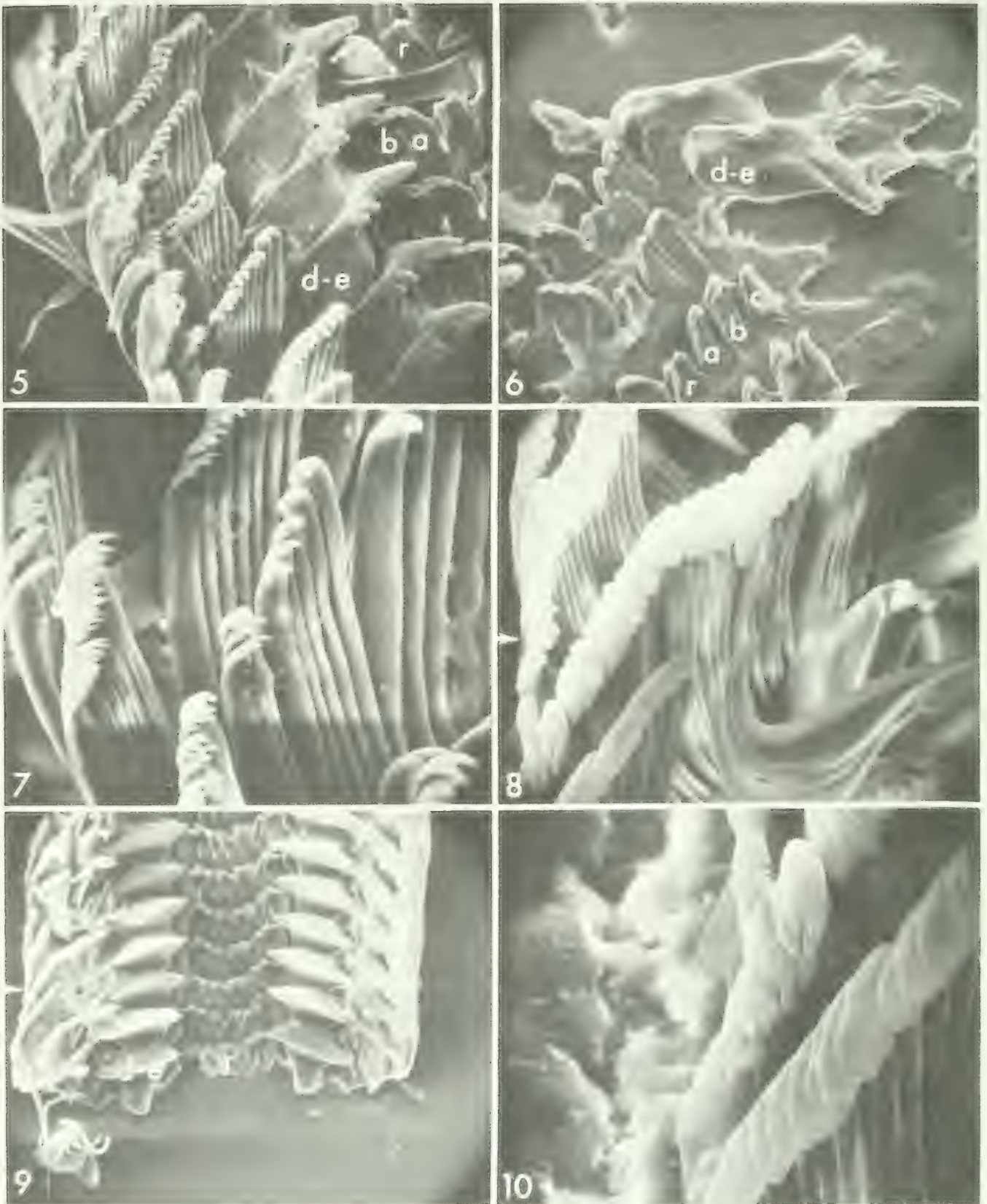

FIGS. 5-10. Scanning electron micrographs of radulae of *Ceres nelsoni* Dall (Figs. 5-7) and *Proserpina nitida* Sby. (Figs. 8-10). Fig. 5.  $\times 339$ . Fig. 6.  $\times 133$ . Fig. 7.  $\times 324$ . Fig. 8.  $\times 632$ . Fig. 9.  $\times 316$ . Fig. 10.  $\times 1270$ . Fig. 8 is an enlargement from area of arrow in Fig. 9. Fig. 10 is an enlargement from area indicated by arrow in Fig. 8. Symbols: r—rhachidian tooth; a, b, c—A-lateral, B-lateral, C-lateral; d-e—capituliform complex (D-plate & E-plate).

just under ventral side of mantle at columellar angle, overlapping anterior half of kidney and part of loop of intestine, and communicating with renal cavity through small renal-pericardial pore lying at base of renal papilla and apex of left auricle. Heart consisting of ventricle and two auricles (Fig. 3); left auricle underlying kidney and receiving efferent pulmonary vein from roof of lung. Right auricle smaller than left, posterior to ventricle and receiving two veins; one from anterior viscera and one from posterior gonadal viscera.

Kidney (Fig. 3) broadly bean-shaped and lying along ventral surface of intestine and partially dorsal to left auricle. Renal papilla clearly distinguishable only near anterior end of kidney, terminating as short ovoid papilla discharging into posterior end of mantle cavity.

*Radula* (Figs. 5–7, 11): Central field consisting of rhachidian tooth and five lateral teeth. Rhachidian tooth simple, trapezoidal, with broad blunt edge (Fig. 6). Basal ligament thin and membranous, lower margin not clearly defined as are basal ligaments of A-, B-, and C-laterals. A-lateral with weak reflection bearing 3 large acuminate cusps, center one

slightly larger. B-lateral with single broad, bluntly pointed central cusp and short blunt cusp on each side. C-lateral with single broad cusp. Capitulum complex consisting of two separate interlocked teeth, the D-lateral and the E-lateral, otherwise referred to as the comb-lateral (D) and the accessory plate (E). Comb lateral (Figs. 5, 11) as in Helicinidae, bearing enlarged acuminate cusps along its rasping edge. Innermost cusp largest, followed laterally by two or three smaller, nearly equal-sized cusps. Outer edge of comb-lateral interlocking into mesad edge of accessory plate to form capitulum complex, a structure superficially appearing as single tooth. Outer edge of radula containing about 45 marginal teeth on each side (Fig. 7). Marginals with expanded bases that attach to basal membrane. First eight marginals bicuspid (Fig. 11); cusps large and rounded; marginals 9–16 tricuspid; outermost marginals with 5 cusps each. I was unable to determine transition point from 4 to 5 cusps because of torn condition of radula examined.

*Female reproductive system* (Figs. 12, 13): Ovary unpigmented, large and discoidal, lying over anterior (cephalic) half of digestive

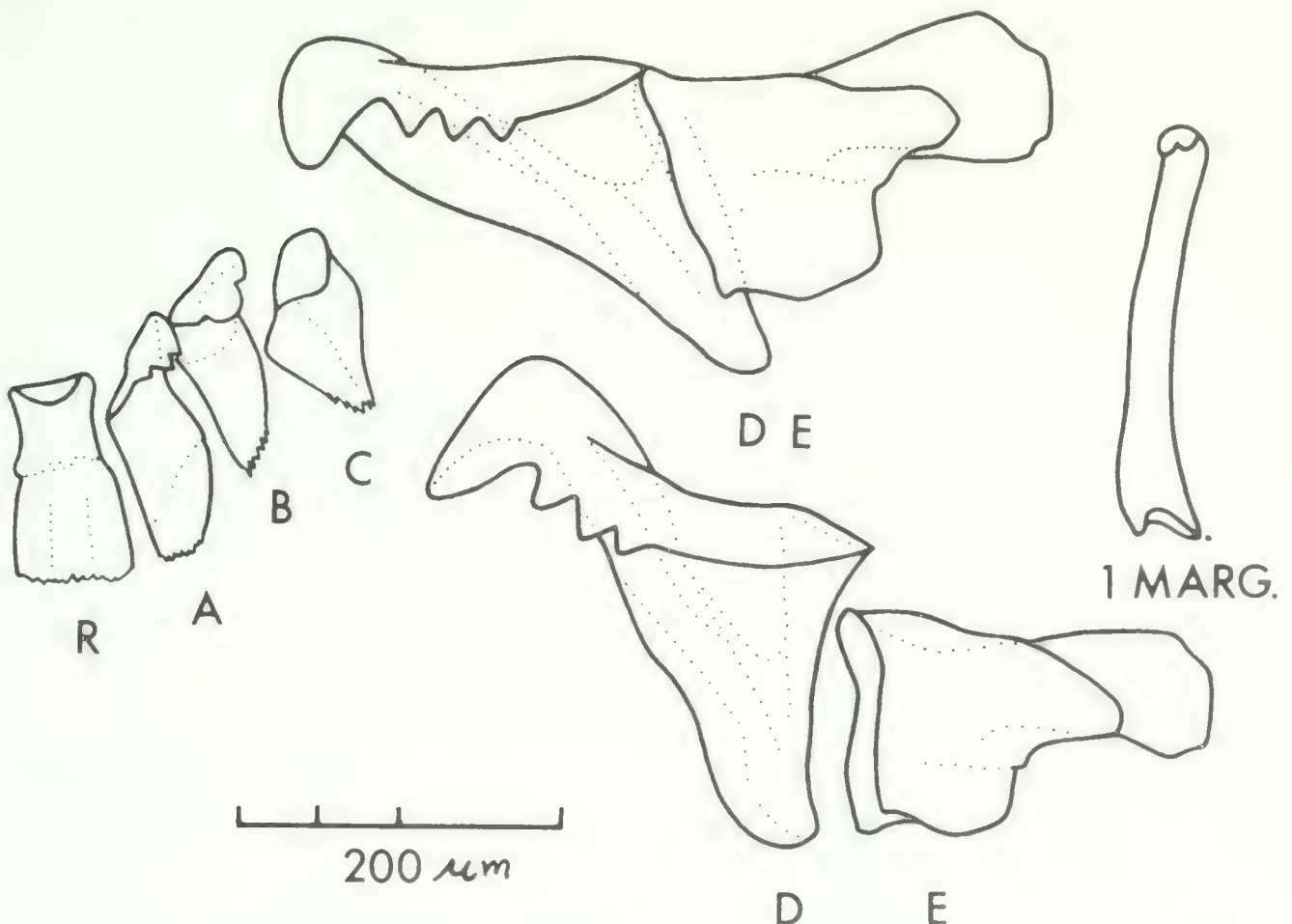

FIG. 11. Radula of *Ceres nelsoni* Dall. R—rhachidian tooth; A, B, C-lateral teeth; D, E-lateral field forming capitulum complex.

gland, and folding partially beneath; consisting of numerous small lobules discharging into collective tubules leading into ovoid egg sac at mesad side of ovary. Primary oviduct short, thick. Pallial genital system (secondary oviduct and associated organs) with two female openings: vaginal opening receives sperm, oviducal opening passes fertilized eggs. Vaginal opening at posterior right corner of mantle cavity just anterior to primary oviduct, and ventral to hypobranchial duct, *not* inside hypobranchial duct as in Helicinidae. Vaginal complex (Fig. 13) consists of short papilliform vagina leading into seminal receptacle and bearing on its upper side large, elongate, weakly lobed provaginal sac and smaller ovoid bursa copulatrix. Provaginal sac wrapped over dorsal side of seminal receptacle and bursa copulatrix, lying on ventral side of V-organ when in natural position (Fig. 12).

Posterior end of secondary oviduct beginning with ascending limb of V-organ, which together with accessory sperm sac form a T-shaped structure on top of descending limb (pedicel). Accessory sperm sac a single large bulb, lying on left side of apex of pedicel and about as large as ascending limb. Pedicel short and stocky, entering into thin-walled seminal receptacle continuing anteriorly into uterus. Uterus strongly folded externally but without accessory ducts or diverticula. Crystalline gland absent at base of uterus. Oviducal opening and anus separate but adjacent just behind mantle collar.

*Male reproductive system* (Fig. 14): Testis similar to ovary in shape and position but with considerably larger lobes. Like ovary, testis partially folded around anterior edge of digestive gland. Vas deferens short and thick, entering apex of prostate at oblique angle. Apex of prostate forming short elliptical chamber continuous with lower chamber of prostate, and occupying same position as provagina in male *Proserpina* and Helicinidae, but histologically not different from prostate. Ventral surface of prostate strongly folded with transverse wrinkles; dorsal surface with elongate field of glandular folds and tubules. Prostate not clearly demarcated into upper and lower segments as in *Proserpina* and the Helicinidae. Elongate field of glandular folds along posterior extremity corresponding to limit of prostate-I in helicinids. Lower prostate very short and otherwise not demarcated. Base of prostate forming short voluminous terminal chamber and bearing two short caeca just above male opening. One caecum overlaps

the other, so only a single one evident superficially. Posterior edge of terminal chamber giving rise to long stout diverticulum appressed against ventral side of prostate and extending to posterior end of prostate-I. Diverticulum regularly creased externally into transverse segments throughout its length and having long longitudinal internal folds partially dividing lumen into parallel chambers. Diverticulum bearing near its base a short stout appendix. Terminal chamber of prostate and intestine having a common opening.

#### *Ceres salleana* Gray

Gray (1856) gave observations on external morphology of the animal and described and illustrated the radula. Boss & Jacobson (1975a: 61) rejected Gray's data on the basis that they suspected Gray had confused the radula of a *Helicina* for *C. salleana*. In light of the information on the radula of *C. nelsoni*, Gray's data must be accepted.

Gray's description and illustration of the radula of *C. salleana* do not properly depict the structure of the capitulum complex. Aside from this difficulty he demonstrated that the radula of *C. salleana* is like that of *C. nelsoni*. Following is a quote of his description:

"... the central rhachidian tooth is oblong, with a smooth, recurved tip, the 1st and 2nd internal teeth A- and B-laterals rather broader than the central, with a three-toothed recurved tip, the 3rd C-lateral narrow, elongate, with a slight recurved end, the 4th and 5th D- and E-laterals, the capitulum complex much larger, oblong and irregular in shape, the 4th about half the width of the 5th, with 3 or 4 denticles on the inner side of the upper edge; the 5th very large, broad, with a large sub-central reflexed lobe; the lateral marginal teeth are very numerous, subequal, compressed, transparent, with a recurved tip, which in the inner teeth of the series is bifid."

#### *Linidiella swifti* (Bland)

Thiele (1931: 90) gave a brief description and figure of the radula of *L. swifti*, which is redrawn (Fig. 24) from his figure. Boss & Jacobson (1975a, b) in their review of the proserpinids overlooked this description. Thiele only briefly described and illustrated the central field, consisting of the rhachidian tooth, the A-, B-, and C-laterals, and the



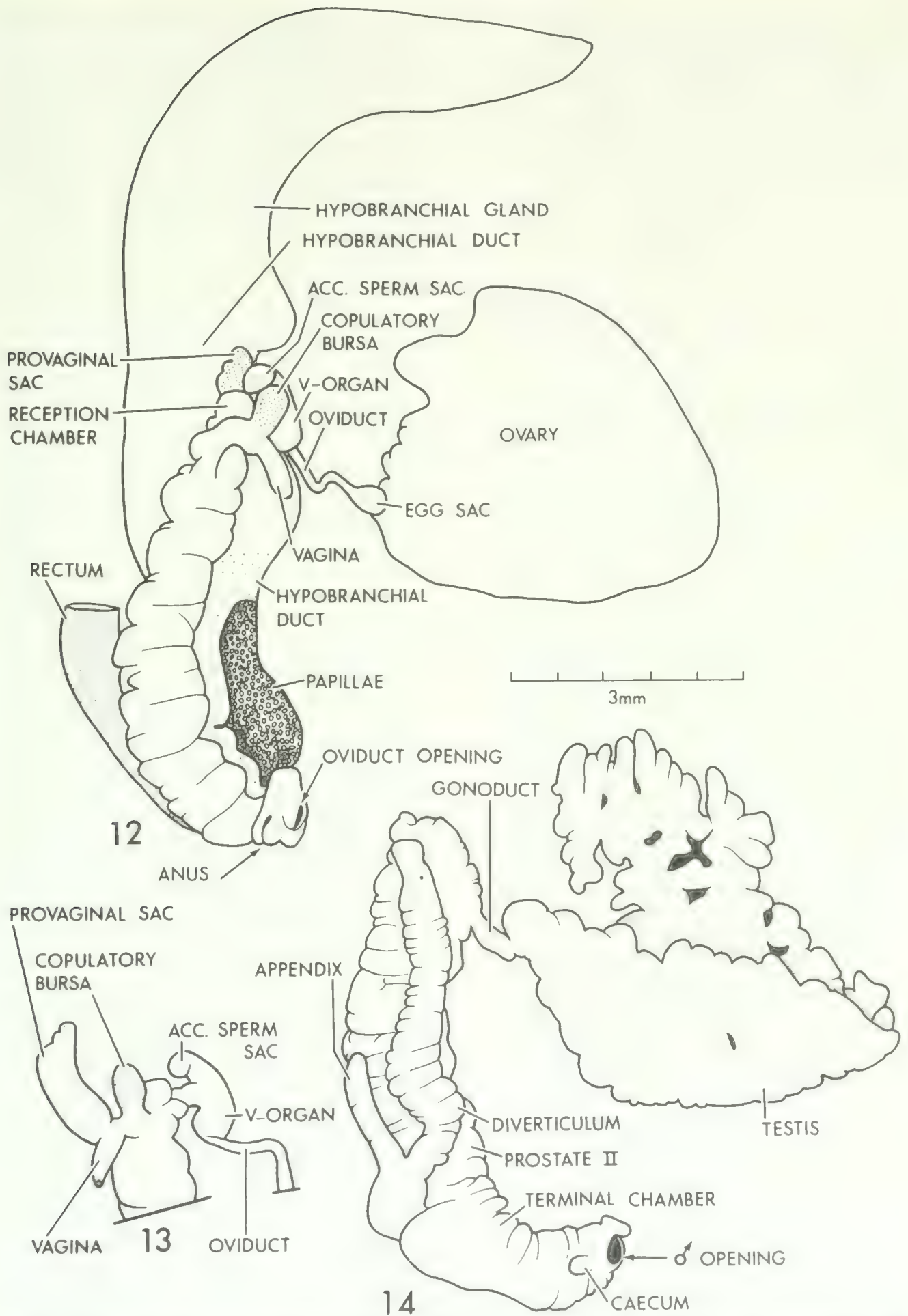

FIGS. 12-14. Reproductive system of *Ceres nelsoni* Dall. Fig. 12. Female system. Fig. 13. Posterior segment of female system with oviduct and associated structures partially separated to show interrelationships of organs. Fig. 14. Male system.

capituliform complex. These teeth are basically similar to those of *Ceres*. The A-, B-, and C-laterals bear about 3 weak cusps along the cutting edge. The D-plate of the capituliform complex is a comb-lateral with about seven distinct acuminate cusps. The innermost cusp is the largest, and the following cusps decrease in size progressively.

*Proserpina (Proserpina) nitida* Sowerby

The following anatomical data are based upon a large series of preserved specimens collected by Glenn Goodfriend 1.3 mi S. Clarmont, St. Ann Parish, Jamaica, 1 November 1976.

*External anatomy:* Foot (Fig. 2) long, slender, keeled above; sole undivided longitudinally; aulacopod, bordered on each side by double row of crenulations. Caudal pore absent, sides lightly spotted with melanophores. Snout white, relatively elongate, separated from foot by deep groove. Pedal gland groove extending around anterior edge of foot and continuing posteriorly with aulacopod groove. Tentacles long, slender, dark gray with light stripe on posterior surface. Eyes at outer base of tentacles. Mantle lappet spotted and mottled like foot but more intensely, nearly uniformly wide, extending posteriorly over edge of shell, and complete around body. Lappet widening over posterior foot and forming pad supporting shell.

Both right and left columellar retractors extend into shell for about one whorl. Both bands slender and dilated near their attachments to shell. Columellar cleft extending posteriorly for about  $\frac{3}{4}$  whorl, separating lower body from upper viscera.

*Pallial organs:* Mantle unpigmented, except over liver and gonad where it is dark gray. Internal organs easily viewed through mantle. Intestine and lower reproductive system terminate about  $\frac{1}{4}$  whorl behind mantle collar. Outer lung wall with very sparse network of small veins most concentrated behind collar (pallial organs shown from ventral surface with mantle removed, Fig. 2). Kidney narrowly concentric, forming a semicircular arch just behind pericardium and beneath loop of intestine. Renal papilla a low ridge on anterior end of kidney, short, blunt and protruding into posterior end of mantle cavity. Pericardium lying beneath left end of kidney but extending obliquely over right end. Right auricle absent. Ventricle slightly wider but shorter than left auricle, receiving anteriorly efferent pulmo-

nary vein, and along left edge two smaller veins from viscera.

*Radula* (Figs. 8–10): Radula not remarkably different from that of *P. depressa* as described by Baker (1926b). Rhachidian tooth simple, parallel-sided and lacking reflection. A-, B-, and C-laterals each with single cusp (radula illustrated, Fig. 9, has anomalous duplicate A-lateral on left side). As in *P. depressa*, A-lateral smaller than B-lateral. Capituliform complex with very heavy scraping cusp on D-plate. Marginal field consisting of 43 blade-like teeth; first 27 unicuspid with sharp anterior edge (Fig. 9); next six bicuspid; next eight (Fig. 10) tricuspid; outermost two with 4–5 long weak cusps each. Inner marginals consisting of broadly triangular plates thickened at base, twisted posteriad, and reflected at upper angle to form spatulate blades. Marginal teeth increasing in length laterally through about 28th tooth; then becoming shorter and narrower at base.

*Female reproductive system* (Figs. 15–16): Ovary very large and circular, occupying almost entire dorsal surface of digestive gland, consisting of multitude of small, convoluted, compactly coiled lobes which discharge into small converging ducts that lead into a relatively large oval egg sac on base of ovary. Primary oviduct short, thick, extending from egg sac to pallial oviduct where it enters through short limb of V-organ. Hypobranchial gland completely posterior to pallial oviduct, discharging into mantle cavity by a short duct. Pallial oviduct bearing at distal end two bulbous structures on end of relatively long pedicel; short, cylindrical V-organ on right side of pedicel, and a large bulbous accessory sperm sac on left side. Sperm sac analogous, not homologous, to accessory sperm sac in Helicinidae. In latter group accessory sperm sac located at end of short duct on side of pedicel; no such structure present in *P. nitida*. V-organ and accessory sperm sac entering a relatively long pedicel that discharges into posterior end of seminal receptacle (Fig. 16). Vagina a short bulbous structure protruding into posterior angle of mantle cavity along left side of pallial oviduct posterior to hypobranchial opening; bearing large weakly lobed provagina and small bursa copulatrix. Provagina wrapped around dorsal side of reception chamber and pedicel; bursa copulatrix lying on ventral side and extending posteriorly. These structures are unwrapped from vagina (Fig. 16) to show interrelationships. Seminal receptacle entering long slen-

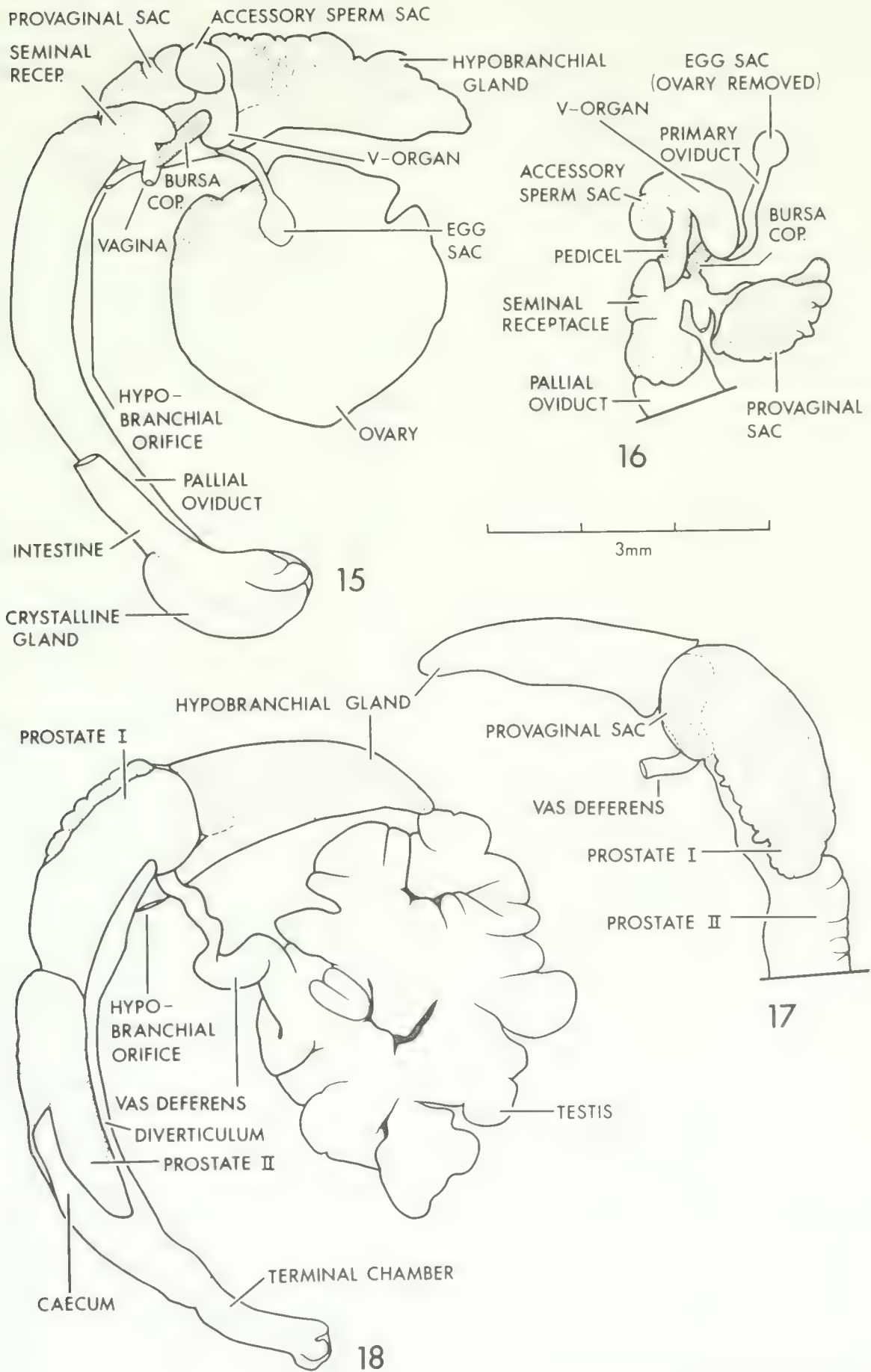

FIGS. 15-18. Reproductive system of *Proserpina nitida* Sby. Fig. 15. Female reproductive system. Fig. 16. Posterior segment of female system with oviduct and associated structures partially separated to show interrelationships of organs. Fig. 17. Male reproductive system. Fig. 18. Ventral view of prostate showing vestigial provaginal sac.

der pallial oviduct-II, bearing at its anterior end elongate crystalline gland. Oviduct and anus close but separate.

*Male reproductive system* (Figs. 17–18): Testis, like ovary, a large circular mass imbedded on dorsal side of digestive gland; consists of numerous lobes similar to, but much larger than those forming ovary. Vas deferens short and stout, entering end of provagina, which is embedded in posterior end of prostate-I (Fig. 18). Prostate-I strongly folded dorsally and continuing into longer, more slender prostate-II, which bears a long, clearly demarcated terminal chamber. Diverticulum originating at junction of prostate-II and terminal chamber, lying along ventral surface of prostate and extending posteriorly to point where vas deferens enters provagina; diverticulum with short, broad appendix about a third of the length of prostate-II. As in female, hypobranchial gland in male lying completely posterior to pallial gonoduct and discharging into mantle cavity by short duct.

#### *Proserpina (Despoenella) depressa* (Orbigny)

Baker's (1926b) description of the radula is quoted here for comparison with *P. (s.s.) nitida* Sowerby:

"The rhachidian central . . . consists of a thin plate with parallel sides. Its anterior edge is weakly notched and has no sign of a reflection or cusp, although its anterior half is slightly thickened. Its posterior edge is very thin, quite irregular and somewhat pointed. The A-central (A) is smaller than the B-plate (B) which is the reverse of their relative sizes in the Vianinae. . ."

"The D-plate is a T-lateral with a broadly crescentic reflection (about half as deep as wide) and a short, stout, stalk. Under dry lenses its cutting edge appears simple and smooth, but under an oil-immersion objective, the entire upper surface is seen to be beautifully striate at right angles to its free margin, which as a result becomes very minutely serrate in worn teeth. The E-plate (E) is relatively larger than, but quite similar in structure to that of most Vianinae; its upper one-fourth is very firmly cemented behind the outer portion of the D-lateral."

" . . . fifty-three to fifty-five uncini are present on each side. The first twenty-two are unicuspid; the next three to five are bicuspid; while the outer teeth increase the number of cusps. The innermost marginals consist of a broadly triangular plate which is thickened at the base and twisted posteriorly and reflected at its upper angle so as to form a spatulate blade. The teeth increase in length from the

inside out and the blades become larger out to about the 12th tooth. The outer marginals are lingulate and multicuspid; the outermost (40, 55) have broad reflected tips with numerous cusplets . . . another specimen has 66 marginals on each side."

## MAJOR TAXA AND PHYLOGENY

### Superfamily relationships

Current classifications of the Gastropoda generally recognize three subclasses: Prosobranchia, Opisthobranchia, and Pulmonata. The Prosobranchia in turn are divided into three orders: Archaeogastropoda, Mesogastropoda, and Neogastropoda (Keen, 1960; Fretter & Graham, 1962; Taylor & Sohl, 1962).

Golikov & Starobogatov (1975) divided the Prosobranchia into three subclasses equal in rank to the Opisthobranchia and Pulmonata: Cyclobranchia, Scutibranchia, and Pectinibranchia. They placed the Turbinomorpha and the Neritimorpha in the Pectinibranchia along with most other prosobranchs otherwise referred to as the Mesogastropoda and Neogastropoda. However, the Turbinomorpha and the Neritimorpha are more like the Scutibranchia in most of their anatomical traits and do not conform to their definition of the Pectinibranchia. For this reason, in part, the earlier classification of the Prosobranchia into Archaeogastropoda, Mesogastropoda, and Neogastropoda is followed in this paper.

The Archaeogastropoda are also referred to as the Diotocardia because of the presence of two auricles on the heart. The Mesogastropoda and the Neogastropoda are collectively referred to as the Monotocardia because of the presence of a single auricle. The Diotocardia have, in general, paired gills, two kidneys, two columellar retractor muscles, and the anal and genital openings at the posterior end of the mantle cavity. Wastes and reproductive products are liberated into the mantle cavity whence they are conveyed to the outside by excurrent water currents.

With the evolution of a conspiral shell there is a strong trend toward reduction of paired organs to single organs because of mechanical pressure on the right side of the pallial region due to allometric growth of the left side. Coupled with this allometric growth is a change in the flow of water current into and out of the mantle cavity, so that the location of a gill on the left (incurrent) side and the loca-

tion of excretory openings on the right (excurrent) side are favored. These trends culminate in the Monotocardia with the evolution of a single (left) auricle, a single (left) gill, a single (left) kidney, a single (right) retractor muscle, a pallial gonoduct that conveys reproductive products to the anterior right corner of the mantle cavity, and an extension of rectum to the anterior right corner of the mantle cavity.

The mollusks constituting the subject of the paper belong to the Superfamily Helicinacea, which in turn belongs to the Infraorder Neritimorpha. The Neritimorpha is an infraorder within the Archaeogastropoda. The Helicinacea are defined as follows:

#### HELICINACEA Thompson, *new superfamily*

Primitive pulmonate archaeogastropods with an exogastric septate shell. Primitively non-operculate. Primitive members with a lamellar barrier partially blocking aperture. More advanced members secondarily operculate. Lung a vascularized open mantle cavity. Gill and osphradium absent. Reproductive system diallic or triaulic, with two or three functional openings. Pallial gonoduct well developed. Spermatophores absent. Pallial rectum present, conveying waste products to outside of mantle cavity. Hypobranchial gland discharging into mantle cavity via a duct, incorporated into reproductive system in the Helicinidae. Pedal nerve cords nearly parallel, and bearing primitive lattice-like arrangement of connectives; supra-intestinal nerve absent; zygoneury occurring between pleural ganglia, and almost occurring between pleural and pedal ganglia and between pedal-pedal ganglia, which are only demarcated by narrow zones where connectives would normally be. Radula rhipidoglossate with central field consisting of single rhachidian tooth. Lateral field consisting of A-, B-, and C-lateral, and next two teeth (rasping or scraping teeth), that combine to form capituliform complex in which D-lateral is functional rasping or scraping tooth.

Within the Neritimorpha the Helicinacea appear to be most closely related to the Neritacea (Neritidae and Septariidae) on the basis of similar radulae, diallic reproductive systems, and nervous systems. The Family Hydrocenidae frequently is placed in close relationship with the Helicinidae, but the hydrocenid radula, monaulic reproductive system, and single (right) columellar retractor

muscle are so divergent from the more primitive anatomical states of the Helicinacea that only a remote relationship can be established on the basis of morphological data (Thiele, 1910; Bourne, 1911; Baker, 1925). The Hydrocenidae should be placed in a separate superfamily, the Hydrocenacea Troschel, 1856, within the Neritimorpha.

The Helicinacea generally have been considered the most advanced group of the Archaeogastropoda because the only information available on the anatomy of the superfamily relates to various species of Helicinidae, the most specialized of the three families in the Helicinacea (Isenkrahe, 1867; Bourne, 1911; Baker, 1925, 1926a, 1926b; Thiele, 1931; Boss & Jacobson, 1975a). The various anatomical traits were attributed, in part, to the evolution of a conspiral shell. Characters in the Helicinidae supporting that classification are: (1) the absence of a right kidney, (2) the presence of a complete pallial gonoduct, (3) the presence of a rectum extending to the front of the mantle cavity, (4) the absence of a right auricle and, (5) the absence of gills. Within the Archaeogastropoda traits (2) and (3) occur only in the Neritimorpha but they are present in nearly all Mesogastropoda and Neogastropoda. These traits are not necessarily advanced morphological traits consequential of the development of a conspiral shell as has been suggested. An alternative hypothesis is that they are consequences of the evolution of a *land snail* from a diotocardian *marine ancestry*. To begin with, neither the Helicinacea nor the Neritacea has a conspiral shell. Basically the shell is limpet-like. Growth occurs in an exogastric direction with partial distortion to the right; but as the shell grows, the right wall dissolves away internally and produces a septate shell. The extent to which growth occurs is evident externally by the number of volutions produced on the apex; internally the only change that has occurred is an increase in space. The snail's body remains limpet-like. In this respect the shell and body of the Helicinacea and the Neritacea are more primitive than the shell and body of the Turbinimorpha which are truly conspiral.

Early in the evolution of the Gastropoda the primary gonoduct evolved to empty into the right renal duct, thus incorporating the right kidney into the reproductive system. Adaptation to a terrestrial environment requires an albumen coating for the egg which serves as a protective aqueous environment in which

the developing embryo can transform without danger of desiccation. This adaptation was accomplished by the evolution of the right kidney into the albumen-secreting provaginal sac of the Helicinacea (Baker, 1925), the precursor of the albumen gland of the Neritacea and higher gastropods. In addition, the evolution of a pallial gonoduct is prerequisite to a terrestrial mode of existence. Archaeogastropods, other than the Neritimorpha, have a simplified reproductive system in which eggs and sperm are released at the posterior end of the mantle cavity and are conveyed by water currents to the outside where fertilization takes place. A terrestrial mode of existence requires the evolution of structural devices to facilitate fertilization and ovipositing to replace the water transport mechanisms of more primitive forms. Thus the pallial gonoduct of the Helicinacea is an adaptation for a terrestrial existence. This adaptation would be required for any terrestrial mollusk regardless of its phylogenetic level, and does not necessarily reflect a higher phyletic level.

Coupled with the evolution of a pallial gonoduct is the evolution of a rectum that conveys waste products outside the mantle cavity. Archaeogastropods, other than the Neritimorpha, are not confronted with the problem of fouling of the mantle cavity for they are aquatic and the mantle cavity is continually flushed by water currents. However, a terrestrial snail does not have this cleansing mechanism and the evolution of a pallial rectum is a necessary adaptation to prevent fouling of the mantle cavity. As a matter of fact, there would be far greater adaptive pressure to evolve a pallial rectum in terrestrial gastropods than in aquatic groups.

Loss of the right auricle of the heart has occurred in most species of the Helicinacea, although two auricles still persist in the two most primitive groups within the superfamily. In *Ceres* (Ceresidae) the right auricle is functional and is nearly as large as the left. In *Hendersonia* (Helicinidae, Hendersoniinae) the right auricle is functional but very much reduced in size. In other helicinaceans the right auricle is lost. The loss of the right auricle in more advanced neritimorphs is a consequence of the crowding of the right side of the pallial region by the pallial gonoduct.

Clearly the loss of a gill is an adaptation for a terrestrial existence, and its absence in the Helicinacea is to be expected. In this connection it should be noted that the gill of some neritids may not be homologous to the gill of

other neritaceans. Fretter & Graham (1962: 307) and Bourne (1908: 853) show that in *Theodoxus*, a freshwater neritid, the gill is innervated by the left pleural ganglion, rather than the supraoesophageal ganglion as occurs in other archaeogastropods. It may be argued that the gill of *Theodoxus* is a new structure evolved to accommodate an aquatic existence in a snail that evolved from a gill-less ancestor. This view was favored by Simroth (1896–1907, 1910) and von Ihering (1877). The only difference between the nervous system of Neritacea and that of Helicinacea is in the divergence of the pedal nerve cords. In the Neritacea the cords strongly diverge at about a 60–75° angle (Bourne, 1908), which probably is a modification consequential to the widening of the foot for adhesion to the rock substrate of an aquatic environment by a limpet-like snail. In Helicinacea the pedal cords are nearly parallel (Bourne, 1911; Baker, 1925; this study, *Ceres nelsoni*, *Proserpina nitida*), which correlates with the narrow, more mobile foot required for terrestrial movement.

The nervous system of Helicinacea, like Neritacea, shows a specialization through zygoneury and loss that make it unlikely that either group could have been ancestral to other orders of Prosobranchia or to the Pulmonata.

From the foregoing data, it is apparent that the Helicinacea are a gill-less pulmonate assemblage of land snails that are properly placed in the Diotocardia. This group has a simplified arrangement of pallial organs due to a reduction in the number of heart chambers and excretory organs and the loss of a gill and an osphradium. A pallial gonoduct and rectum were evolved to accommodate terrestrial existence, and the hypobranchial gland is modified to discharge into the mantle cavity through a duct. Primitively this group was non-operculate, protecting the opening of the limpet-like shell with a partial septum and a lamellar barrier (Ceresidae, Proserpinidae). Secondarily, an operculum was evolved to close the aperture (Helicinidae). Which group of marine mollusks was ancestral to the Helicinacea is not clear. However, it is apparent that on the basis of the shell, the operculum, the gill, the radula (Baker, 1923b), the heart, and the reproductive system (Fretter & Graham, 1962; Bourne, 1908) the Neritacea is not ancestral to the Helicinacea. Internal fertilization through a pallial gonoduct and the complete pallial rectum of the Helicinacea of-

fer advantages that allow these systems to persist in more advanced aquatic groups. They are not required for an aquatic mode of life (as in the Turbinimorpha), but they are required for a terrestrial mode of life. Once evolved they are likely to be retained in terrestrial or aquatic lineages.

#### FAMILY RELATIONSHIPS WITHIN THE HELICINACEA

The Helicinacea include three families, the Helicinidae, Ceresidae, and Proserpinidae. The Helicinidae is further divided into three subfamilies, Helicininae, Hendersoniinae and Vianinae. The latter two subfamilies apparently are natural groups definable by anatomical criteria and shell characteristics. The Helicininae are a heterogeneous assemblage that includes several disparate groups. Two of these ("Ceratomiscinae" and "Stoastomatidae") are separable from the helicinids (s.s.) on the basis of shell and opercular traits. The few observations published on their radula do not show significant differences from Helicininae (Pilsbry & Brown, 1910; Baker, 1922; Thiele, 1927). All other aspects of stoastomid and ceratomiscid soft anatomy are unknown, and so they are excluded from further discussion in this paper (see Boss, 1972, for a discussion of the subgenera of *Stoastoma* and Boss, 1973, for a monograph of *Ceratomiscus*).

Twenty-three characters are useful for separating families and subfamilies within the Helicinacea and for showing relationships among the groups involved. Because of the structural diversity that occurs within the Helicinidae, it is necessary to redefine the family and its two subfamilies Hendersoniinae and Vianinae in order to discuss relationships within the Helicinacea.

#### CERESIDAE Thompson, *new family*\*

*Type-genus: Ceres* Gray, 1856.

This family has the following combination of characteristics: SHELL: (1) operculum absent; (2) periostracum present; (3) shell marked with radial sculpture. EXTERNAL ANATOMY: (4) foot holopod; (5) mantle collar not extending out over shell; (6) tentacles long, slender; (7) axial cleft separating last whorl very short, about 0.1 whorl long; (8) heart with two functional, nearly equal-sized

auricles; (9) kidney broad, irregularly ovate in shape; (10) hypobranchial gland very long, overlapping posterior half of pallial gonoduct; (11) hypobranchial duct extending length of pallial oviduct; open along lower half. REPRODUCTIVE SYSTEM: (12) rectum and pallial gonoduct terminating at mantle collar; (13) vagina opening directly into posterior corner of mantle cavity, not inside hypobranchial duct; (14) gonad large, flattened, oval in shape; (15) egg sac present at origin of primary oviduct; (16) primary gonoduct very short, thick; (17) prostate not divided into upper and lower division, provaginal sac absent in males; (18) accessory sperm sac consisting of tubular bulb at left end of pedicel opposite ascending limb of V-organ; (19) crystalline gland absent. RADULA: (20) A-, B-, and C-lateral teeth with 2-3 serrated cusps; (21) capituliform complex consisting of a comb-lateral (D-lateral) and accessory plate (E-lateral); (22) accessory plate (E-lateral) with broad wing enveloping end of D-lateral; (23) innermost marginal teeth with three cusps, outer marginals polycuspid.

Characteristics 7, 8, 9, 10, 11, and 17 are unique to the Ceresidae.

A prior family-group taxon name, Proserpinellinae (Baker, 1923a) was proposed for members of this family, based upon the oldest named genus within the group. Considering the scant information available about *Proserpinella* it is ill-advised to base a family name on a genus that is so poorly known. There is no marked precedent in malacology for giving priority to the oldest name available for families (Baker, 1956a, 1956b), nor can there be where so many names were spuriously founded.

#### Family PROSERPINIDAE Gray, 1847, REDEFINED

*Type-genus: Proserpina* Sowerby, 1839.

SHELL: (1) operculum absent; (2) periostracum absent; (3) shell smooth, without radial or spiral sculpture. EXTERNAL ANATOMY: (4) foot aulacopod; (5) mantle collar extending fully or partially out over shell; (6) tentacles long and slender; (7) axial cleft about  $\frac{3}{4}$  whorl long; (8) heart with single auricle (left); (9) kidney narrowly crescent-shaped; (10) hypobranchial gland short, triangular in shape, confined posteriorly to pallial gonoduct; (11) hypobranchial duct short, opening at posterior

\*Thompson has already used this name in an abstract (*Bulletin of the American Malacological Union* for 1979 [published early 1980], p. 63). EDS.

end of mantle cavity. REPRODUCTIVE SYSTEM: (12) rectum and pallial gonoduct terminating some distance from mantle collar as in Hendersoniinae; (13) vagina opening directly into posterior mantle cavity, not into hypobranchial duct; (14) gonad huge, discoidal; (15) egg sac present at origin of primary oviduct; (16) primary gonoduct very short, stout; (17) prostate divided into two divisions, prostate-I and prostate-II; provaginal sac vestigial within prostate-I; (18) accessory sperm sac consisting of tubular bulb at left end of pedicel opposite ascending limb of V-organ; (19) crystalline gland present at base of pallial oviduct. RADULA: (20) A-, B-, and C-lateral teeth unicuspid; (21) capituliform complex consisting of T-lateral (D-lateral) and accessory plate (E-lateral); (22) accessory plate (E-lateral) reduced in size, without wing; (23) innermost marginal teeth unicuspid. Outer marginals with few to several cusps.

Characteristics 2, 3, 4, 5, 10, 17, and 19 are unique to the Proserpinidae.

Family HELICINIDAE (HELICININAE)  
Férussac, 1822, REDEFINED

*Type-genus: Helicina* Lamarck, 1799.

(For anatomical data see Thiele, 1902; Bourne, 1911; Baker, 1926a.)

SHELL: (1) operculum present, concentric; (2) periostracum present; (3) shell marked with radial and/or spiral sculpture. EXTERNAL ANATOMY: (4) Foot holopod; (5) mantle collar not extending out over edge of shell; (6) tentacles long and slender; (7) axial cleft separating last whorl of body about  $\frac{1}{2}$  whorl long; (8) heart with single auricle (left); (9) kidney narrowly concentric in shape; (10) hypobranchial gland elongate, overlapping posterior end of pallial gonoduct; (11) hypobranchial duct not extending beyond posterior half of pallial gonoduct. REPRODUCTIVE SYSTEM: (12) Rectum and pallial gonoduct terminating just behind mantle collar; (13) vagina opening into hypobranchial duct (female diaulic); (14) gonad smaller, elongate; (15) egg sac absent on primary ovary; (16) primary gonoduct relatively long; (17) prostate divided into prostate-I and prostate-II. Provaginal sac absent in males; (18) accessory sperm sac located near middle of right side of pedicel, consisting of small bulbous sac at end of short narrow duct; (19) crystalline gland absent. RADULA: (20) A-, B-, and C-laterals usually with several cusps; cusps frequently reduced or absent on

A-lateral; (21) capituliform complex consisting of comb-lateral (D-lateral) and accessory plate (E-lateral); (22) accessory plate with or without wing enveloping end of D-lateral; (23) innermost marginal teeth with 2–3 cusps. Outer marginals polycuspid.

Only four traits found in all species examined are unique to the Helicinidae (s.l.) This small number is due to the anatomical diversity within the family and the structural modifications and losses that have occurred within the various phyletic lines. These traits are: (1) operculate, (13) vagina opening into hypobranchial duct, (14) gonad small and elongate, and (16) primary gonoduct moderately long.

Within the Helicinidae several trends occur which progress from generalized states, as found in the Hendersoniinae, to modified states, as found in the Helicininae on the one hand and in the Vianinae on the other (Baker 1925, 1926a). These include: (a) modification of operculum from paucispiral type to concentric type, (b) increasing complexity of shell sculpture, (c) reduction and loss of right auricle, (d) increased length of pallial gonoduct and hypobranchial duct, (e) simplification and elongation of female primary oviduct, (f) translocation of accessory sperm sacs on pedicel, (g) general reduction of cusps on radular teeth, (h) tendency for D-lateral tooth to change from comb-lateral to T-lateral, and (i) reduction in structural complexity of E-lateral tooth.

Characters listed for Helicinidae also characterize the subfamily Helicininae. In the following two subfamilies, Hendersoniinae and Vianinae, only characters that differ from the Helicininae are given.

Subfamily HENDERSONIINAE Baker, 1926a,  
REDEFINED

*Type-genus: Hendersonia* Wagner, 1905.

(For anatomical data see Baker, 1925.)

SHELL: (1) operculum paucispiral; (3) shell marked with radial sculpture. EXTERNAL ANATOMY: (7) axial cleft about 1 whorl long; (8) heart with two functional, unequal-sized auricles, right auricle almost vestigial; (11) hypobranchial duct short, opening into posterior end of mantle cavity. REPRODUCTIVE SYSTEM: (15) egg sac present at origin of primary oviduct; (16) primary gonoduct moderately long; (18) accessory sperm sac consisting of several small bulbs on left side of



pedicel opposite ascending limb of V-organ. RADULA: (20) A-, B-, and C-laterals with several cusps each; (22) accessory plate (E-lateral) with broad wing enveloping end of D-lateral; (23) innermost marginal teeth with three cusps, outer marginals polycuspid.

Subfamily VIANINAE Baker, 1922,  
REDEFINED

*Type-genus: Viana* H. and A. Adams, 1856.

(For anatomical data see Isenkrahe, 1867; Baker, 1926a.)

EXTERNAL ANATOMY: (6) tentacles short and conical in shape; (9) kidney narrowly crescent-shaped; (11) hypobranchial duct less than half length of pallial gonoduct. REPRODUCTIVE SYSTEM: (16) primary gonoduct long. RADULA: (20) A-, B-, and C-lateral teeth usually without cusps; (21) capituliform complex consisting of a T-lateral (D-lateral) and accessory plate (E-lateral); (22) accessory plate (E-lateral) reduced in size, without wing; (23) innermost marginal teeth unicuspid, outer marginals with one or few cusps.

#### FAMILY COMPARISONS

Numbers in parentheses refer to the characteristics given for the families Ceresidae and Proserpinidae. These two families are alike in only seven characteristics: (1) they lack opercula, (6) the tentacles, (13) the opening of the vagina into the mantle cavity, (14) the size and shape of the gonad, (15) the presence of an egg sac on the primary oviduct, (16) the structure of the primary gonoduct, and (18) the location of the accessory sperm sac. They differ in sixteen traits: (2) the periostracum, (3) shell sculpture, (4) the foot structure, (5) the mantle collar, (7) the axial cleft, (8) the number of auricles on the heart, (9) the structure of the kidney, (10), the location of the hypobranchial gland, (11) the length of the hypobranchial duct, (12) the openings of the pallial gonoduct and rectum, (17) the structure of the prostate, (19) the presence of a crystalline gland, and (20–23) all aspects of the radula.

Ceresidae and Helicinidae. The two families are alike in twelve characteristics: (2) the periostracum, (3) shell sculpture, (4) the foot structure, (5) the mantle collar, (6) the tentacles (except Vianinae), (10) the location of the hypobranchial gland (except Hender-

soniinae), (12) the openings of the rectum and pallial gonoduct, (19) the absence of a crystalline gland, and (20–23) similar radula (except Vianinae). The two families differ in eleven characteristics: (1) the presence of an operculum, (7) the axial cleft, (8) the number of auricles (except Hendersoniinae), (9) the structure of the kidney, (11) the length of the hypobranchial duct, (13) the opening of the vagina, (14) the size and shape of the gonad, (15) the presence of an egg sac, (16) the structure of the primary gonoduct, (17) the structure of the prostate, and (18) the location of the accessory sperm sac.

Proserpinidae and Helicinidae. The two families are alike in eleven characteristics. Five are shared with only the Hendersoniinae. Similarities are: (6) the tentacles (except Vianinae), (7) the axial cleft (Hendersoniinae only), (8) the auricles (except Hendersoniinae), (9) the structure of the kidney, (10) the location of the hypobranchial gland (Hendersoniinae only), (11) the length of the hypobranchial duct (Hendersoniinae only), (12) the openings of the rectum and pallial gonoduct (Hendersoniinae only), and (20–23) the structure of the radula (Vianinae only). The two families differ in nineteen traits: (1) the presence of an operculum, (2) shell sculpture, (4) the foot structure, (5) the mantle collar, (7) the length of the axial cleft, (10) the location of the hypobranchial gland, (11) the length of the hypobranchial duct, (12) the openings of the rectum and the pallial gonoduct, (13) the opening of the vagina, (14) the size and shape of the gonad, (15) the presence of an egg sac, (16) the structure of the primary gonoduct, (17) the presence of a prostatic provaginal sac, (18) the location of the accessory sperm sac, (19) the presence of a crystalline gland, and (20–23) all characteristics of the radula (except Vianinae).

From the foregoing data it is clear that the Ceresidae and the Proserpinidae are less closely related to each other than either is to the Helicinidae. Furthermore, recognition of the three groups as separate families is warranted by the degree of evolutionary divergence that has occurred.

The traits that are characteristic of the Ceresidae are primitive morphological states; whereas the traits unique to the Proserpinidae are advanced (derived) morphological states. The traits unique to Helicinidae indicate that it is also an advanced group compared to the Ceresidae but not to the same degree nor in the same lineage as is the Proserpinidae.

Morphological traits indicating these phylogenetic relationships are as follows: The ceresid right auricle is functional and only slightly reduced in size. It persists in the Hendersoniinae as a small, functional vestige. It is completely absent in other heliciniids and proserpinids. The ceresid (left) kidney is large and ovate. In the other families it is reduced in size and is crescent-shaped. The vestige of the right kidney (provaginal sac) persists in both sexes in the Proserpinidae. The provaginal sac persists only in females in the other two families. The vagina opens directly into the posterior corner of the mantle cavity in the Ceresidae and the Proserpinidae. In the Helicinidae it is incorporated into the hypobranchial duct. In Ceresidae the gonad is large and ovate, an egg sac is formed at the base of the primary gonoduct, and the accessory sperm sac is located on the left side of the pedicel. With regard to the opening of the vagina, the size of the gonad, the presence of an egg sac, and the location of the accessory sperm sac, the Proserpinidae are similar to the Ceresidae in retention of primitive characters as compared to the Helicinidae. In the Helicinidae the gonad is reduced in size, an egg sac is absent, and the accessory sperm sac is translocated to the right side of the pedicel (except in *Hendersonia*). In the Ceresidae the prostate is undivided. In the other two families it is divided into prostate-I and prostate-II. In addition, the Proserpinidae has evolved a crystalline gland, de novo, at the base of the reception chamber. The ceresid radula is generalized in all its traits. The central field teeth are heavily cusped, all the marginal teeth are multicusped, and the capituliform complex has a generalized comb-lateral and accessory plate. In Helicinidae a complete transition occurs in cusp reduction, transformation of the comb-lateral to a T-lateral, and simplification of the accessory plate. In the Proserpinidae these changes also are completed.

Similarities between the proserpinid and the vianid radula apparently are due to convergence, for little morphological similarity otherwise exists between the two groups. On the contrary, greater morphological similarity exists between the proserpinids and the

hendersoniines than between the proserpinids and other groups. The traits unique to the Ceresidae, Proserpinidae and Helicinidae necessitate recognizing these groups as distinct families. The aulacopod foot and the crystalline gland of the Proserpinidae are sufficient reasons for separating that family and indicate an extensive degree of divergence from the other two families.

MINOR TAXA AND SYSTEMATIC OBSERVATIONS

CERESIDAE Thompson, 1980

*Type-genus: Ceres* Gray, 1856.

The Ceresidae are known only from Mexico and South America and contain five genera. *Ceres* is the only genus that is known anatomically. The radula of *Linidiella* has also been described. It is like the radula of *Ceres* and unlike the radula of the West Indian Proserpinidae. On the basis of shell structure *Linidiella* is most similar to *Proserpina*, but a close relationship (family) between the two is not tenable on the basis of their radular differences. Thus *Linidiella* is tentatively referred to Ceresidae. The other three mainland genera are also provisionally assigned to Ceresidae because their shells are more similar in structure to *Linidiella* than to *Proserpina*. Because the radula of *Linidiella* is a generalized type of helicincean radula, similarities to *Ceres* may only indicate a generalized relationship within the Helicinacea. Additional anatomical data on the South American genera may necessitate further division at the family or subfamily level. *Dimorphoptychia* from the Paleocene of Europe has shell characters that could place it in the Ceresidae. Wenz (1938: 435) places it in a separate subfamily, the Dimorphoptychinae. Since *Dimorphoptychia* is known only as a fossil shell, speculation about its relationship to modern groups is highly arbitrary. I find no advantage in uniting it in the same family with *Ceres*, because shell characters are not absolutely useful for showing relationships among modern families (e.g., *Proserpina* and *Linidiella*).

KEY TO THE GENERA OF CERESIDAE

- 1) Shell 15–25 mm in major diameter; rugosely sculptured above, striate below; strongly keeled at periphery; with six apertural lamellae—two parietal, one columellar and three palatal ..... *Ceres*

- 1a) Shell seldom over 15 mm in major diameter; sculptured with weak growth striations and occasionally microscopic granules or punctations; periphery rounded; aperture with 0–2 lamellae confined to columella and/or parietal wall ..... 2
- 2) Aperture with two lamellae, one on parietal wall and one on base of columella . *Staffola*
- 2a) Aperture with fewer than two lamellae ..... 3
- 3) Aperture without lamella, although a small denticle may be present on base of columella .  
..... *Archecharax* n.g.
- 3a) Aperture with single lamella ..... 4
- 4) Lamella confined to columella ..... *Linidiella*
- 4a) Lamella confined to parietal wall ..... *Proserpinella*

*Ceres* Gray, 1856

*Ceres* Gray, 1856: 100. Type-species: *Carocolla eolina* Duclos, 1834, by subsequent designation (Kobelt, 1879: 203).

The shell is characterized by having six lamellae within the aperture: two parietal, one columellar, and three palatal. The shell is strongly keeled, has rugose sculpture on the spire and bears strong growth striations below. Three species have been described from eastern Mexico. The anatomy of one, *C. nelsoni*, and the radula of another, *C. salleana*, are described earlier in this paper.

*Ceres eolina* (Duclos)

*Carocolla eolina* Duclos, 1834: pl. 30.  
*Odontostoma (Carocolla) eolinum* (Duclos), Pfeiffer, 1848: 11.  
*Proserpina eolina* (Duclos), Pfeiffer, 1853: 290; Martens, 1890: 44; Martens, 1901: 609.  
*Ceres eolina* (Duclos), Gray, 1856: 102; Pfeiffer, 1856: pl. 35, figs. 23, 24.

*Type-locality:* State of Veracruz, Mexico.  
*Distribution:* Mexico, Veracruz: Cerro de Palma, Sierra de Matlaquihahuitl, near Toxpan (Martens, 1901: 609). This is the only locality recorded for this species.

*Ceres nelsoni* Dall

*Ceres nelsoni* Dall, 1898: 27–28; Dall, 1902: 501, pl. 28, figs. 1, 3, 5, 8; Solem, 1954: 7.  
*Type-locality:* Pilitla [Xilitla], San Luis Potosí, Mexico.  
*Distribution:* Known only from the states of San Luis Potosí and Tamaulipas in eastern Mexico. Specimens examined.—San Luis

Potosí: Sotano del Rancho de la Barranca, 5 km NNE Ahuacatlan (UF 24404—1 shell, UF 24405—6 preserved animals); Sotano de Guadalupe, 10 km SW Aquismon (UF 24406—5 preserved animals, UF 24903—1 shell); 19 km E Xilitla, 350 m alt. (UF 24091a—1 preserved animal, UF 24901—19 shells, UF 24902—5 shells); 10 km NE Xilitla, 300 m alt. (UF 24900—5 shells); 12 km E Xilitla, 730 m alt (UF 24899—1 shell). Tamaulipas: Solem (1954: 7) records this species from Aserradero del Paraiso, 15 km NNW Chamla (UMMZ<sup>2</sup>).

*Ceres salleana* Gray

*Ceres salleana* Gray, 1856: 100–102; Pfeiffer, 1876: 295.  
*Proserpina salleana* (Gray), Pfeiffer, 1856: 322, pl. 35, figs. 21, 22; Martens, 1890: 45.

*Type-locality:* Cordera [Cordova], Veracruz, Mexico.  
*Distribution:* Known from localities immediately near the type-locality in Veracruz, Mexico: Orizaba; Cerro de Palma, Sierra de Matlaquihahuitl, near Toxpan (Martens, 1901: 609); Barranca de las Puentes (Martens, 1890: 45).

*Staffola* Dall, 1905

*Staffola* Dall, 1905: 202. Type-species by monotypy: *Proserpina (Staffola) derbyi* Dall, 1905.  
*Staffola* is a monotypic genus which is characterized among ceresids by having two lamellae, one on the parietal wall and one projecting downward from the base of the columella. Sculpture consists only of a few incremental striations. However, the only

<sup>2</sup>Museum of Zoology, University of Michigan.

known material of the genus consists of the eroded subfossil holotype of *S. derbyi* and details about the sculpture cannot be adequately determined. The base of the shell has a thin umbilical callus.

Keen et al. (1960: 1288) and Boss & Jacobson (1975a, 1975b) synonymized *Staffola* with *Cyane* (= *Archecharax*). Even though *S. derbyi* hitherto has been unfigured, Dall's description gives due notice to the columellar lamella and the parietal lamella, which immediately separates *Staffola*. It was for this reason that Dall proposed a subgeneric relationship between *Staffola* and *Proserpina*, but continued to recognize *Cyane* (= *Archecharax*) as a distinct genus.

Additional observations on the holotype of *S. derbyi* are necessary to characterize *Staffola* among other South American genera. The holotype of *S. derbyi* is redescribed and figured herein.

#### *Staffola derbyi* (Dall)

*Proserpina* (*Staffola*) *derbyi* Dall, 1905: 202.

*Type-locality*: Calcareous banks of the arroyo of the Rio Chico at Paraguassa, State of Bahia, Brazil; holotype: USNM<sup>3</sup> 185454.

*Shell* (Figs. 19–21): 4.9 mm in major diameter; depressed globose, being about 0.55 times as high as wide. Spire weakly convex in outline with sharply pointed apex. Apical whorl slightly raised above succeeding whorl. Shell very thick for its size, strongly callused internally along peristome. Whorls 4.0. Suture not impressed, vaguely apparent along last whorl. Thin callus superimposed on suture forming a rather uniformly narrow spiral band. Body whorl nearly uniformly rounded peripherally but with tendency to flatten below periphery. Details of surface sculpture of holotype not clear due to weathered condition of shell, but few weak incremental growth wrinkles parallel to peristome distinguishable on shoulder of last eighth whorl. Base of shell with thin umbilical callus extending out as far as parietal lamella. Callus bearing weak minute granules, most of which are eroded. Umbilical region indented due to abrupt vertical descent of columellar wall of last eighth whorl. Aperture semilunar, with parietal and columellar lamella. Parietal lamella relatively thick and low, about one-eighth whorl long and lying about a third of distance from col-

umella to posterior angle of aperture. Columellar lamella projecting obliquely downward as tongue-like projection from columella, continuing into shell for about eighth whorl, and forming narrow bay-like notch at base of columella. Columella oblique in frontal view, ridged above and curved forward at base. Dorsal lip deeply indented near suture. Outer lip receding basolaterally, as does basal lip near columella. Peristome sharp-edged but with strong internal callus.

*Remarks*: This species is unusual because of its thick shell. No other ceresid approaches the condition that occurs in *S. derbyi*. Inasmuch as all ceresids live on calcareous rocks, the thickness of the shell in this case cannot be attributed to a factor of the habitat, but almost certainly is intrinsic. Another peculiarity of the species is the strongly receded dorsal lip that forms a distinct notch near its insertion with the preceding whorl. The depth of the notch is partially obscured in the holotype because the edge of the lip just outside the notch is broken. In Fig. 21 this is reconstructed on the basis of the curvature of the adjacent non-broken parts of the lip. The holotype of *S. derbyi* is eroded to the extent that the surface sculpture and details are obscured, and the outline of the suture is only apparent. My figure shows the course of the superimposed callus and not the underlying suture. It is notable that there is no perceptible impression of a suture. Other ceresids have at least a weakly impressed suture separating the whorls.

*S. derbyi* diverges strongly from other species in the structure of the apertural lamellae. It is unique among South American ceresids in possessing a parietal lamella, or to put it another way, *Linidiella* and *Archecharax* are unique by lacking a parietal lamella. The columellar lamella is dissimilar in its basic features to other ceresid genera. In contrast with other genera, the columellar lamella projects obliquely downward as an extension of the columella and forms a narrow U-shaped notch with the basal lip. The lamella resembles a tongue-like projection from the columella and curves into the aperture for about a quarter of a whorl. It appears to be a derivation from the truncate columellar condition such as occurs in *Archecharax*. It has little similarity to the columellar lamella of *Linidiella* or *Proserpina*, in which genera the columella tapers into the basal lip, and the lamella lies at

<sup>3</sup>National Museum of Natural History, Washington D.C

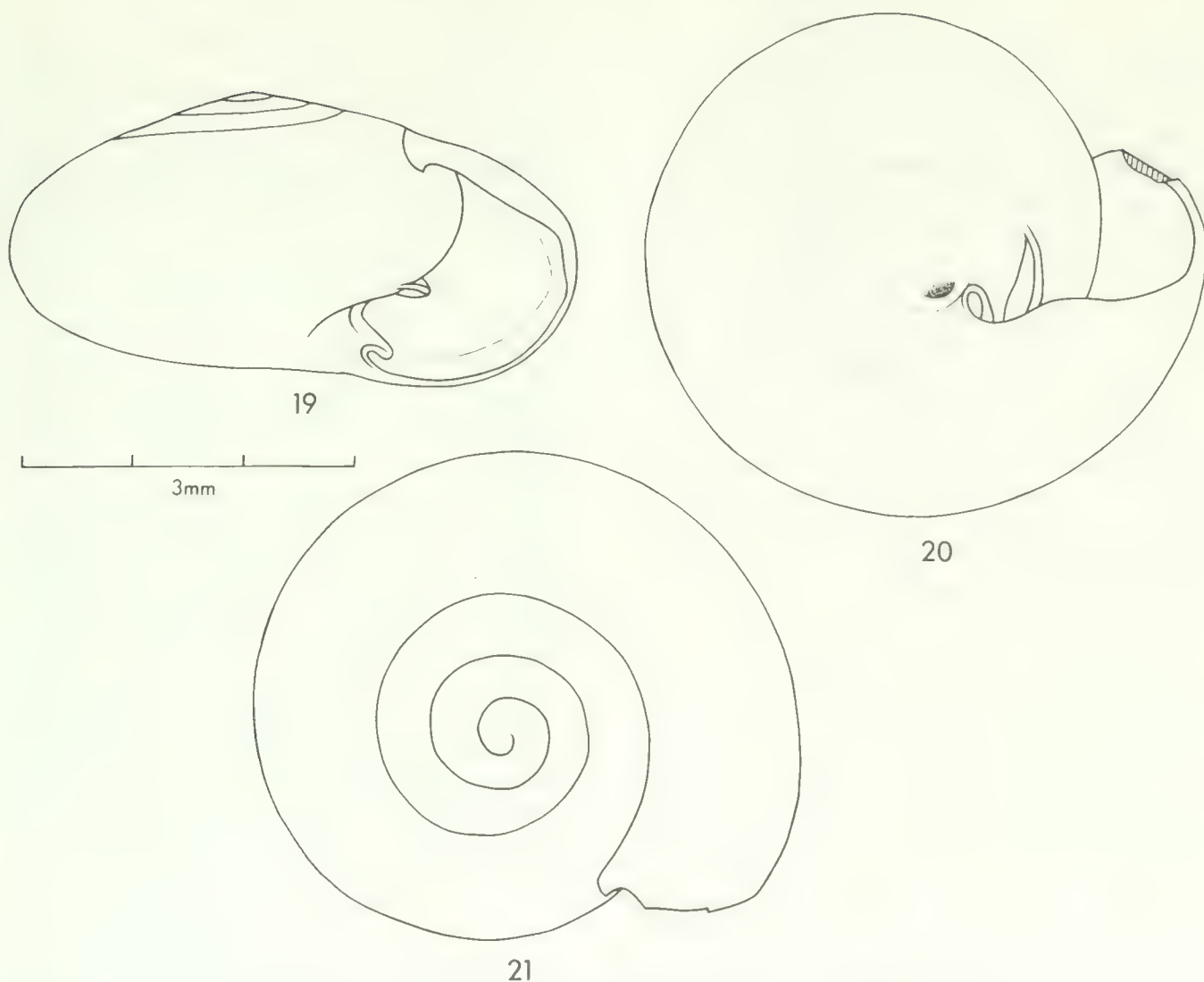

FIGS. 19–21. *Staffola derbyi* (Dall). (Holotype: USNM 185454).

a right angle on the columella about a third of the distance from the parietal wall to the basal lip. Apparently the columellar lamella of *Staffola*, *Linidiella* and *Proserpina* are independently derived, representing cases of convergent evolution in this structure.

*Linidiella* Jousseume, 1889

*Linidiella* Jousseume, 1889: 256; Baker, 1923: 84. Type-species by subsequent designation (Baker, 1923: 84): *Proserpina swifti* Bland, 1863.

*Chersodespoena* Sykes, 1900: 136. Type-species by original designation: *Despoena* (*Chersodespoena*) *cinnamomea* Sykes, 1900.

Shell with single lamella at base of columella. Columella concave, thickened, and grading into lamella. Sculpture consisting of fine, irregularly spaced incremental striations that become more distinct on periphery and base. Interspersed between striations on base

of shell are numerous minute elongate granules which become more concentrated near umbilical region. Umbilical callus not evident; indicated at best by concentrated granular sculpture. Dorsal surface of shell lacking granular or punctate sculpture. Enamel deposit overlapping suture to form spiral line lying about midway between sutures. The radula is discussed earlier in this paper.

*Linidiella* contains three species. Two are from the Andes of northern South America and one is from Chiapas, Mexico. They are placed together in *Linidiella* because each has a spiral lamella at the base of the columella. I suspect that the similarity among the species based on this character is superficial and that two separate lineages are represented. *L. sulfureous* from Chiapas differs significantly from the two Andean species in that its shell is nearly devoid of granular sculpture, and incremental striations are hardly distinguishable. The species are as follows: each is known certainly only from its type locality.

*Linidiella swifti* (Bland)

*Proserpina swifti* Bland, 1863: 16–17; Bland, 1865: 155, fig. 1.

*Cyane swifti* (Bland), Thiele, 1927: 90, fig. 65.

*Type-locality*: mountains between Puerto Cabello and Valencia, Venezuela.

Miller (1879: 148) listed this species from "Ecuador" on the basis of specimens obtained by Higgins. Aside from this record the species is known only from the type-locality. The specimens that I have examined (UF 19053) are merely labeled "Venezuela." They came from C. T. Simpson and may have been received from Thomas Swift, who originally discovered this species. These specimens are figured (Figs. 22–23) to contrast *Linidiella* with *Staffola* and *Archecharax*.

*Linidiella cinnamomea* (Sykes)

*Despoena (Chersodespoena) cinnamomea* Sykes, 1900: 136–137, fig.

*Type-locality*: between Ayabamba and Santa Rosa, Ecuador.

*Linidiella sulfureous* Thompson

*Linidiella sulfureous* Thompson, 1967: 61, figs. 1–3.

*Type-locality*: 8.2 mi. S. Solusuchiapa, Chiapas, Mexico; 1600 ft. alt.

*Archecharax* Thompson,  
*new generic name*

*Cyane* H. Adams, 1870: 376. Non *Cyane* Felder, 1861; Lepidoptera.

*Type-species*: *Cyane blandiana* H. Adams, 1870.

*Etymology*: The name *Archecharax* is derived from the Greek *arche*, first cause, and *charax*, a pointed stake. It alludes to the structure of the columella. The name is masculine.

A genus of the family Ceresidae with the following characteristics (all aspects of its soft anatomy are unknown). Aperture lacking internal lamella; columella truncate, may project forward basally as denticle; periostracum absent. Sculpture particularly noticeable on base and side of whorls, consisting of rather

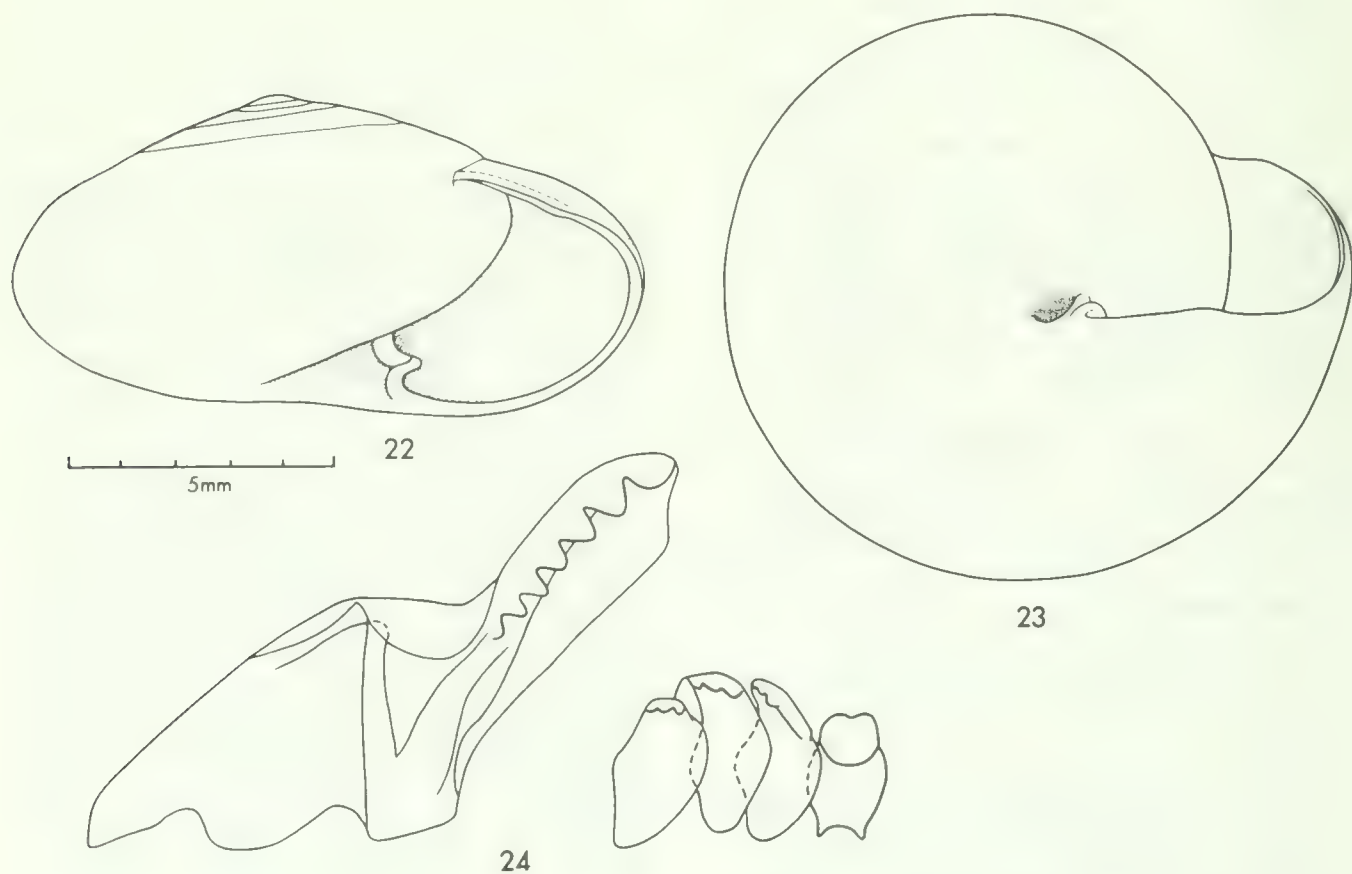

FIGS. 22–24. *Linidiella swifti* (Bland). Figs. 22–23. Two specimens from Simpson Collection (UF 19053). Fig. 24. Radula redrawn from Thiele, 1931: 90.

regularly spaced incremental striations between and within which numerous small granules occur in radial patterns.

*Archecharax* is immediately distinguishable from other ceresids and proserpinids by having a truncate columella and lacking lamellae within the aperture. Equally striking is the presence of regularly spaced growth striations

and radially arranged granular tubercles on the base and sides of the whorls outside the basal callus.

*Archecharax* is known from the foothills and outer mountain ranges of the Andes from Colombia south to Bolivia. Four extant species are described. These may be separated by the following key:

KEY TO THE SPECIES OF *ARCHECHARAX*

- 1) Dorsal and ventral surface with conspicuous spiral rows of punctate sculpture ..... *A. blandianus* (H. Adams)
- 1a) Shell without spiral or punctate sculpture ..... 2
- 2) Shell large, 13–15 mm in major diameter; depressed, less than 0.55 times as high as wide ..... 3
- 2a) Shell smaller, less than 10 mm in major diameter; conic-globose, more than 0.60 times as high as wide ..... *A. orbignyi* (Ancy)
- 3) Shell yellowish with red spiral band about midway between suture and periphery; spire weakly convex in outline ..... *A. cousini* (Jousseume)
- 3a) Shell uniformly amber colored; spire weakly concave in outline . *A. glaeserius* new species

*Archecharax blandianus* (H. Adams)

*Cyane blandiana* H. Adams, 1870: 376; pl. 27, figs. 2, 2a.

*Type-locality*: "Eastern Peru."

This species has not been recorded since its discovery. Its original description and figures are deficient in some details. It is described and figures herein based upon material I collected in 1969.

*Shell* (Figs. 25–27): Depressed-helicoid, about 10 mm in major diameter and about 0.59–0.69 times as high as wide. Largest specimen examined with about 5.3 whorls (UF 24359). Spire weakly concave in outline; apex rounded. Body whorl slightly swollen, evenly rounded at periphery; base moderately convex. Suture weakly impressed on last two whorls, not at all on earlier whorls. Umbilicus imperforate, but with a dimple-like impression that lies behind the columellar insertion. Periphery of impression rather abrupt. Protoconch consisting of 0.6 whorl, set off by a distinct transverse crease. First half whorl of protoconch smooth, subsequent 0.1 whorl with a few weak radial striations; following whorls with incremental striations, within and between which are close spiral striations that may be broken into short linear segments or rows of shallow punctations (Figs. 31, 32). Spiral sculpture most conspicuous near su-

ture and on base, weakest around periphery (Fig. 27). Parietal area without apparent callus or deposit; spiral sculpture continuing into aperture undiminished. Aperture semi-lunar; without lamellae. Columella conspicuously thickened, concave and slightly twisted at base, forming very weak forward-projecting denticle. Dorsal lip extending forward and inserted well above periphery of preceding whorl. Outer lip and basal lip nearly straight in lateral profile.

Size is highly variable. Measurements in mm for the five largest specimens examined are:

			Aperture		Whorls
	Width	Height	Width	Height	
UF 24355	7.0	4.6	3.2	3.1	5.0
UF 24356	7.7	5.1	3.8	4.0	4.6
UF 24357	5.8	4.0	2.6	2.6	4.7
UF 24358	9.8	6.2	4.8	4.2	5.2
UF 24359	7.3	4.3	3.3	2.8	5.0

*Distribution*: Known only from eastern Peru in vicinity of Tingo Maria. This is a region of extensive limestone karst formations.

*Specimens examined*: Peru: Huanuco Province; Tingo Maria, 750 m alt. (UF 24356.5); 4.7 km S Tingo Maria, 750 m alt. (UF 24350.4); 9.2 km S Tingo Maria, 800 m alt. (UF 24357.1); 14.9 km NE Tingo Maria, 800 m alt. (UF 24358.2).

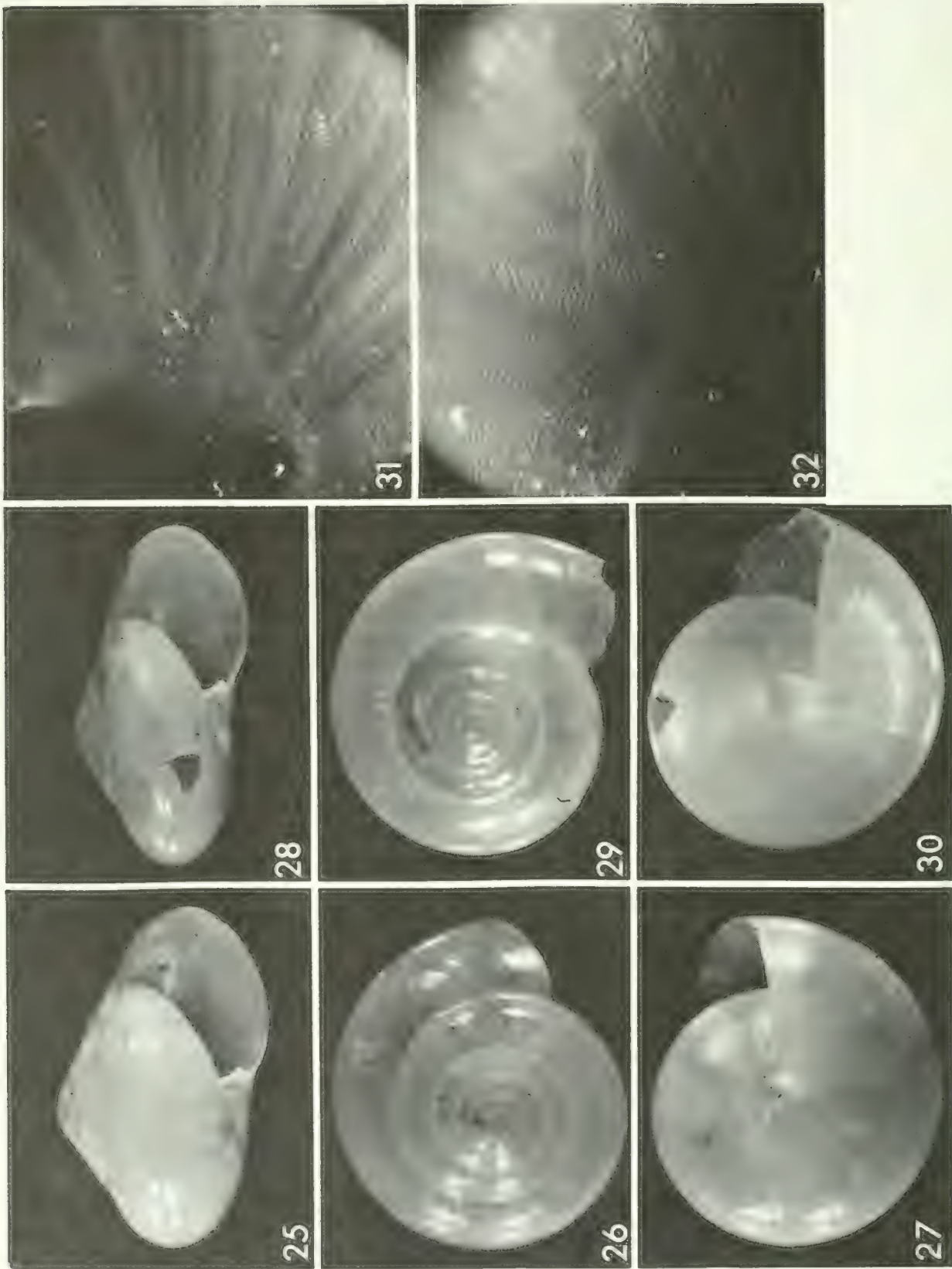

FIGS. 25-27. *Archecharax blandianus* (Adams) (UF 24359). FIGS. 28-30. *Archecharax glaeceus* new species (Holotype: UF 24355). FIGS. 31-32. *Archecharax blandianus* (Adams) (UF 24356). SEM of base just behind lip showing radial and granular sculpture. Fig. 31.  $\times 42.4$ . Fig. 32.  $\times 108$ .



*Remarks:* The distinct spiral punctate sculpture on the dorsal surface of the whorls in *A. blandianus* is different from the sculptural traits of any other related species, and on the basis of that character alone separate generic status for *A. blandianus* is justifiable. Perhaps the three other species that I assigned to *Archecharax* should be placed in a new subgenus because of the absence of such spiral sculpture. Until better material is available I prefer not to make such an allocation.

*Archecharax orbigny* (Ancey)

*Cyane orbigny* Ancey, 1892: 178.

*Type-locality:* Santa Cruz de la Sierra, Bolivia.

*Distribution:* known only from the type-locality.

*Archecharax cousini* (Jousseaume)

*Proserpinella cousini* Jousseaume, 1887: 181–182, pl. 3, figs. 15, 16.

*Type-locality:* "Ecuador."

*Distribution:* Ecuador, but not known from any precise locality.

*Archecharax glaeserius* Thompson, *new species*

*Type-locality:* Colombia, Departamento Valle, 3 km W Atoncelo, 1380 m alt., Holotype: UF 24355; collected 1 March 1969 by Fred G. Thompson. The type-locality is at the head of a deep ravine in a mountain rain forest near the top of a mountain range lying west of Dagua and Atoncelo. The unique holotype was found at the base of a huge calcareous sandstone boulder in the ravine.

*Shell* (Figs. 28–30, 33–36): major diameter about 16 mm; depressed helicoid, being about 0.54 times as high as wide. Spire elevated, slightly concave in profile due to expansion of last whorl. Periostracum absent. Shell opaque, glossy, amber yellow, except for white umbilical callus with regularly spaced, narrow darker yellow streaks paralleling line of growth, visible through surface gloss. Umbilical area with thin granular callus strongly indented immediately behind the columella due to abrupt vertical wall of last whorl at that point (Fig. 36). Whorls 4.7; suture moderately depressed and covered by thin glaze forming narrow transparent zone extending onto preceding whorl and partially obscuring suture. Glaze with numerous small

dimples and pits randomly dispersed over suture area. Protoconch with 1.0 whorl, smooth, elevated above succeeding whorl; very weakly set off from succeeding whorl by faint rest striation. Subsequent whorl smooth but with sparse, fine, incremental striations most noticeable on base and rarely distinguishable above. Microsculpture on base consisting of numerous minute granules tending to be aligned between incremental striations and arranged in a spiral course. Granules densest on basal callus and disappearing near periphery of whorl. Aperture 0.83 times as high as wide, deeply indented by preceding whorl. Lamella absent. Peristome simple, sharp; columella weakly concave, oblique; base truncate, extending forward as weak denticle accentuated by receding basal lip. Denticle does not continue internally as lamella but curves upward uniformly into columella.

Measurements in mm of the unique holotype are: width, 15.7; height, 8.4; aperture width, 7.0; aperture height, 5.8.

*Remarks:* The species is most similar in its shell characters to *A. cousini* (Jousseaume). Both species have a smooth spire devoid of spirally arranged rows of punctate sculpture, are similar in size and relative height, and both have a small denticle-like projection at the base of the columella. *A. glaeserius* is immediately separated from *A. cousini* by the color of its shell and the contour of its spire. *A. glaeserius* is uniform amber yellow and has a weakly concave spire. *A. cousini* possesses a red spiral band on a yellow background, and has a weakly convex spire.

*A. cousini* is known only from its holotype, for which Jousseaume gives only a brief description and an outline illustration. Apparently the relationship between *glaeserius* and *cousini* is close, but their differences are sufficient to consider them distinct species. Additional collections may show they are subspecifically related.

*Proserpinella* Bland

*Proserpinella* Bland, 1865: 157. Type-species by monotypy: *Proserpinella berendti* Bland, 1865.

The genus is characterized by having a smooth, discoidal shell that bears a delicate parietal lamella. Other lamellae are absent. The columella is truncate, similar to that in *Archecharax*. A thin umbilical callus is present.

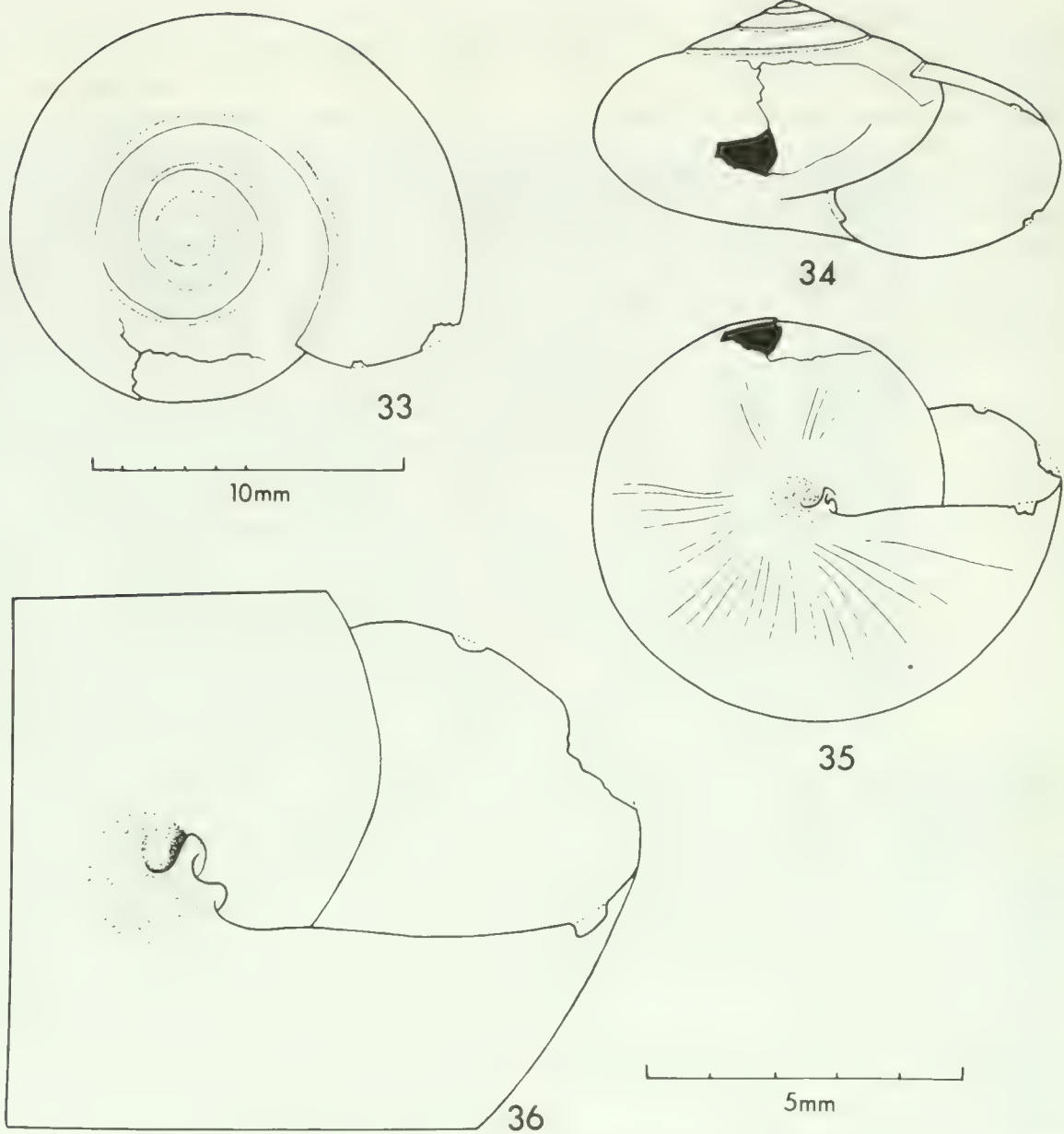

FIGS. 33–36. *Archecharax glaeceus* new species (Holotype: UF 24355). Fig. 36. Enlargement showing detail of columellar area. 10 mm scale for 33–35, 5 mm scale for 36.

*Proserpinella* is an obscure genus of minute Mexican land snails; two species have been described. Nothing is known about them other than the descriptions of their shells. Each is known only from its type-locality.

*Proserpinella berendti* Bland

*Proserpinella berendti* Bland, 1865: 157, fig. 2; Strebel, 1873: 11, pl. 4, fig. 5; Martens, 1890: 45.

*Type-locality*: Mirador, Veracruz, Mexico, 3000–4000 ft alt.

*Proserpinella hanna*e Dall

*Proserpinella hanna*e Dall, 1926: 486–487, pl. 36, figs. 6–8.

*Type-locality*: Maria Madre Island, Tres Marias Islands, Nayarit, Mexico.

PROSERPINIDAE Gray, 1847

This family is endemic to the Greater Antillean Islands of Cuba, Jamaica, and Hispaniola, and contains two genus-group taxa, *Proserpina* Sowerby, 1847, and *Despoenella* Baker, 1923. Conventionally *Despoenella* is treated as a subgenus of *Proserpina*. Equally valid reasons can be given for treating it as a separate genus. For the purposes of this paper I follow previous authors and treat them as subgenera. However, recognition of them as subgenera or distinct genera on the basis of our current knowledge is subjective. *Proserpina* is characterized by having a columellar lamella, two parietal lamellae, and two

palatal lamellae. *Proserpina* is restricted to Jamaica and contains two species. *Despoenella* has a columellar lamella and a single parietal lamella. Palatal lamellae are absent. *Despoenella* contains two species each on Cuba and Jamaica and three on Hispaniola.

Until now the only information available dealing with internal anatomy is Baker's (1926b) description of the radula of *P. (Despoenella) depressa* (Orbigny), the type-species of *Despoenella*. Data on the soft anatomy of *P. nitida* Sowerby, the type-species of *Proserpina* are presented earlier in this paper. These data are the basis of characterizing the Proserpinidae as a distinct family. Two new species of *Despoenella* are also described. In view of the excellent monograph on the Proserpinidae by Boss & Jacobson (1975a), further discussion of most other species is not necessary.

*Calybium* from Southeast Asia may be a proserpinid, but it is only known from its shell and radula (see Baker, 1922: 64–65), and its relationship within the proserpinid-helicinid complex remains unclear.

#### *Proserpina* Sowerby

##### Subgenus *Proserpina*, s.s.

*Proserpina* Sowerby, 1839: 124; Boss & Jacobson, 1975: 67–69. Type-species: *Proserpina nitida* Sowerby, 1839, by monotypy.

*Despoena* Newton, 1891: 255. New name for *Proserpina* Sowerby, 1839, non *Proserpinus* Hubner, 1816, Lepidoptera.

#### *Proserpina (Proserpina) nitida* Sowerby

*Proserpina nitida* Sowerby, 1839: 124, fig. 274; Boss & Jacobson, 1975a: 69–72, pl. 10, figs. 1–5.

*Proserpina nitida planulata* C. B. Adams, 1851: 174.

*Type-locality*: Jamaica.

*Distribution*: widely distributed throughout the central portion of Jamaica.

#### *Proserpina (Proserpina) linguifera* (Jonas)

*Helicina linguifera* Jonas, 1839.

*Proserpina allognoto* Jonas, 1846. New name for *Helicina linguifera* Jonas, 1839.

*Proserpina pulchra* C. B. Adams, 1850: 81.

*Proserpina linguifera* (Jonas), Pfeiffer, 1850: 12, pl. 103, figs. 12–15; Boss & Jacobson, 1975a: 72–74, pl. 10, figs. 6–7.

*Type-locality*: Jamaica.

*Distribution*: known only from St. Elizabeth Parish and Westmoreland Parish, Jamaica.

#### Subgenus *Despoenella* Baker

*Odontostoma* Orbigny, 1842: 238. Type-species: *Odontostoma depressa* Orbigny, 1842. Non *Odontostoma* Turton, 1830, Gastropoda.

*Despoenella* Baker, 1923: 85. New name for *Odontostoma* Orbigny, 1842, non *Odontostoma* Turton, 1830. Boss & Jacobson, 1975a: 74.

#### *Proserpina (Despoenella) globulosa* (Orbigny)

*Odontostoma globulosa* Orbigny, 1842: 239, pl. 18, figs. 8–11.

*Proserpina globulosa* (Orbigny), Pfeiffer, 1850: 12, pl. 12, figs. 19–21; Boss & Jacobson, 1975a: 84–87, pl. 13, figs. 4–6.

*Type-locality*: Interior of island of Cuba.

*Distribution*: Widely disjunct in its distribution in Oriente and Pinar del Rio Provinces, Cuba, and the Isle of Pines.

#### *Proserpina (Despoenella) pisum* C. B. Adams

*Proserpina pisum* C. B. Adams, 1850b: 108. Boss & Jacobson, 1975a: 82–84, pl. 13, figs. 103.

*Type-locality*: Jamaica.

*Distribution*: Confined to western Jamaica where it is found in Westmoreland, St. James, and Trelawny Parishes.

#### *Proserpina (Despoenella) depressa* (Orbigny)

*Odontostoma depressa* Orbigny, 1842: 238, pl. 18, figs. 4–7.

*Helicina ptychostoma* Pfeiffer, 1848: 12.

*Proserpina depressa* (Orbigny), Pfeiffer, 1853: 291; Baker, 1926b: 451 (radula); Boss & Jacobson, 1975a: 75–78, pl. 11, figs. 1–3.

*Proserpina depressa rubrocincta* (Torre, MS, Aguayo & Jaume, 1947: 88 (*nomen nudum*); Aguayo & Jaume, 1957: 124, pl. 1, fig. 10.

*Type-locality: Odontostoma depressa* Orbigny: interior of the isle of Cuba; restricted by Aguayo & Jaume (1947: 88) to Pan de Guajaiboa, Pinar del Rio, Cuba. *Helicina ptychostoma* Pfeiffer: Callajabas [=Caya-jabos], Pinar del Rio, Cuba. *Proserpina depressa rubrocincta* Aguayo & Jaume: Los Acostas, Luis Lazo, Pinar del Rio, Cuba.

*Distribution:* widely disjunct; confined to Pinar del Rio Province and Havana Province in western Cuba and Oriente Province in eastern Cuba.

*Proserpina (Despoenella) bidentata*  
C. B. Adams

*Proserpina bidentata* C. B. Adams, 1850a: 81; Boss & Jacobson, 1975a: 79–80; pl. 12, figs. 4–6.

*Type-locality:* Jamaica.

*Distribution:* confined to the John Crow Mountains, Portland Parish, Jamaica.

*Proserpina (Despoenella) marcanoi* Clench

*Proserpina marcanoi* Clench, 1962: 2, pl. 1, fig. 3; Boss & Jacobson, 1975a: 80–82, pl. 12, figs. 1–3.

*Type-locality:* Colonia Ramfis [=Colonia Majagual], 20 km W of San Cristobal, San Cristobal Province, Dominican Republic.

*Distribution:* known only from the type-locality.

*Remarks:* observations are given below with the following species.

*Proserpina (Despoenella) scudderæ*  
Thompson, *new species*

*Etymology:* this species is named for Sylvia Scudder, Technician, Florida State Museum, who assisted in field work in the Dominican Republic in 1974.

*Type-locality:* Dominican Republic, Barahona Prov., Sierra de Baoruco, 7 km NNE Polo, 910 m alt. The type-locality is in a deep limestone ravine. On my first visit in January 1974 the ravine was shaded by a wet mountain forest that was partly planted with coffee. At the time of the most recent visit (January 1977) the ravine was deforested along both sides with cattle pasture on the

north slope and open coffee grove on the south slope.

*Holotype:* UF 24326; collected 18 June 1974 by Fred G. Thompson.

*Paratypes:* UF 24327 (19), UF 24328 (25), UF 24329 (5), FMNH<sup>4</sup> 195426 (2), ANSP<sup>5</sup> (2), MCZ<sup>6</sup> 288377 (2). Museo Nacional de Historia Natural, Republica Dominicana (5). All paratypes are topotypic.

*Shell* (Figs. 37–41): small, 5.2–5.9 mm in diameter; discoidal, adult shells 0.47–0.49 times as high as wide (0.48 in holotype); whorls 4.5–5.0 (4.8 in holotype). Spire depressed. Embryonic whorl conspicuously protruding. Last whorl flattened above and rounded below so that periphery of shell lies above middle. Color light greenish-yellow dorsally, lighter below (only dead shells have been collected; live specimens probably are brighter green than the material I have examined). Surface of shell glossy with thin enamel-like wash that overlaps suture and extends about halfway onto previous whorl. Shell fairly translucent, showing regularly spaced, thin incremental lines of growth through outer wash. Dorsal surface and sides of whorls smooth. Ventral surface with thin white basal callus that is very minutely granular. Callus extending outward as arc continuing forward from parietal lamella. Columellar margin of umbilical area indented, forming short abrupt wall that causes base to be weakly pitted (Figs. 38, 40). Aperture semi-lunar, equal to or slightly higher than wide, 0.38–0.44 times width of shell (0.39 in holotype). Aperture with parietal lamella and columellar lamella, both extending into aperture about 1/5 whorl (Fig. 41). Parietal lamella located about third distance from columella to posterior angle of aperture. Columellar lamella located just above middle of columella and about half as high as parietal lamella. Lip strongly sinuous in outline, strongly receded at periphery and along base. Columella oblique, lying at about 30° to vertical axis of shell. Columella accentuating umbilical pit by having pillar-like thickening between parietal wall and columellar lamella.

Measurements of 12 specimens selected to show maximum variations (holotype in parentheses): height, 2.5–2.8 mm (2.7); width, 5.2–5.9 mm (5.6); aperture height, 2.1–2.4 mm (2.3); aperture width, 2.1–2.3 mm (2.2).

<sup>4</sup>Field Museum of Natural History, Chicago.

<sup>5</sup>Academy of Natural Sciences of Philadelphia.

<sup>6</sup>Museum of Comparative Zoology, Cambridge, Mass

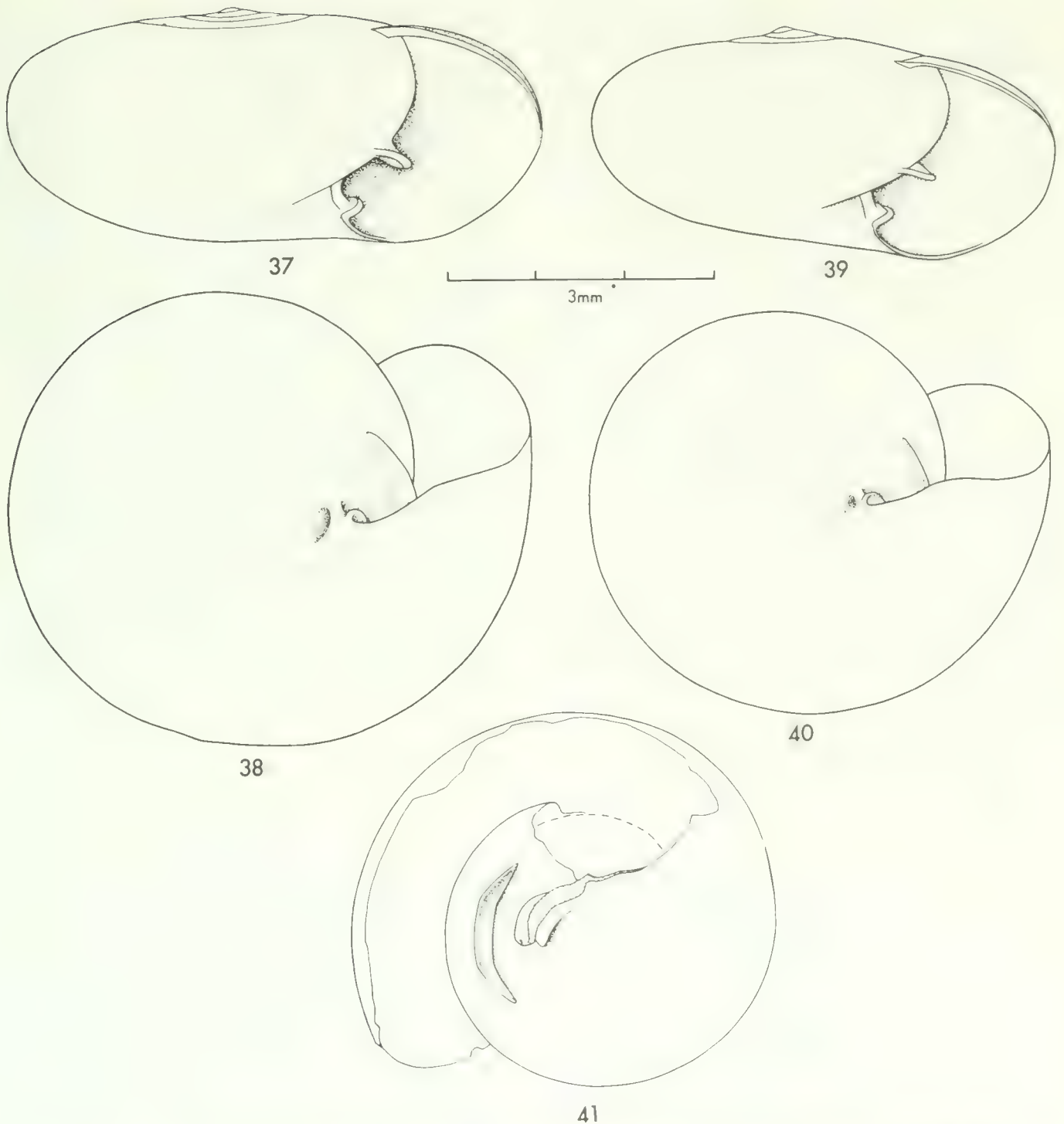

FIGS. 37–41. *Proserpina (Despoenella) scudderæ* new species. Figs. 37–38. Large paratype (UF 24328). Figs. 39–40, small paratypes (UF 24328). Fig. 41. Paratype opened to show lamella (UF 24328).

*Distribution:* this snail has been found only in the Sierra de Baoruco, near Polo, Dominican Republic, where it was collected on limestone outcrops in wet forests. Records in addition to the type-locality are: 6 km NNE Polo, 1000 m alt. (UF 24332); 5 km NNE Polo, 990 m alt. (UF 24331); 2 km NNE Polo, 765 m alt. (UF 24333); 3 km SE Polo, 750 m alt. (UF 24330).

*Remarks:* this is a member of the subgenus *Despoenella* by virtue of possessing two lamellae within the aperture, a parietal lamella, and a columellar lamella. It differs

from most of its subcongeners by its discoidal shape and its protruding embryonic whorl. Its differences from *P. planior* are described below under that species. Adult shells are less than 0.50 times as high as wide with the periphery lying above the middle of the last whorl. Other species of *Despoenella*, except *P. planior*, are helicoid or depressed-helicoid in shape with the periphery of the shell lying at the middle of the last whorl, and the embryonic whorl is not conspicuously elevated above the succeeding whorls.

The subgenus *Despoenella* is divisible into

three species groups. One group includes *P. pisum* C. B. Adams from Jamaica and *P. globulosa* (Orbigny) from Cuba. They look alike in having globose or subglobose shells (see Boss & Jacobson, 1975a). These two species need not be considered further for comparison with *P. scudderæ* because of their shapes. The second species group includes *P. depressa* (Orbigny) from Cuba, *P. bidentata* C. B. Adams from Jamaica, and *P. marcanoi* Clench. They are alike in having depressed helicoid shells. Differentiation within this group is slight. *P. depressa* differs by its larger size. Adults attain a diameter of about 7–8 mm. *P. bidentata* and *P. marcanoi* reach a diameter of about 5 mm. *P. bidentata* and *P. marcanoi* are hardly separable. *P. bidentata* has a weaker indentation at the base of the columella than does *P. marcanoi* but other shell differences are nonexistent. They are treated as distinct species because they occur on different islands (Boss & Jacobson, 1975a). A third species group includes *P. scudderæ* and *P. planior* from Hispaniola which differ from other *Despoenella* by

their discoidal shape, with a height/width ratio of less than 0.50, and having protruding embryonic whorls. (See Figs. 42–44 for comparisons with *marcanoi*, Figs. 47–48 for *bidentata*, and Figs. 45–46 for *depressa*.)

*Proserpina marcanoi*, *P. scudderæ*, and *P. planior* are found in Hispaniola. Each is highly restricted in its geographical distribution. *P. marcanoi* is known only from its type-locality, Colonia Majagual, San Cristobal Prov., Dominican Republic (formerly known as Colonia Ramfis). This is a small community located on the road from Gambito Garabitos to El Guineo, and is about 12 km NW of Gambito Garabitos. The area is mountainous and formerly was covered with wet forest which is replaced with coffee groves. The substrate consists primarily of metamorphic and igneous rocks. There are a few isolated outcrops of highly metamorphosed limestones. *P. marcanoi* is known only from the three specimens that comprise the type series. I visited the region of its type-locality on four occasions and was unsuccessful in finding additional specimens. *P. scudderæ* is

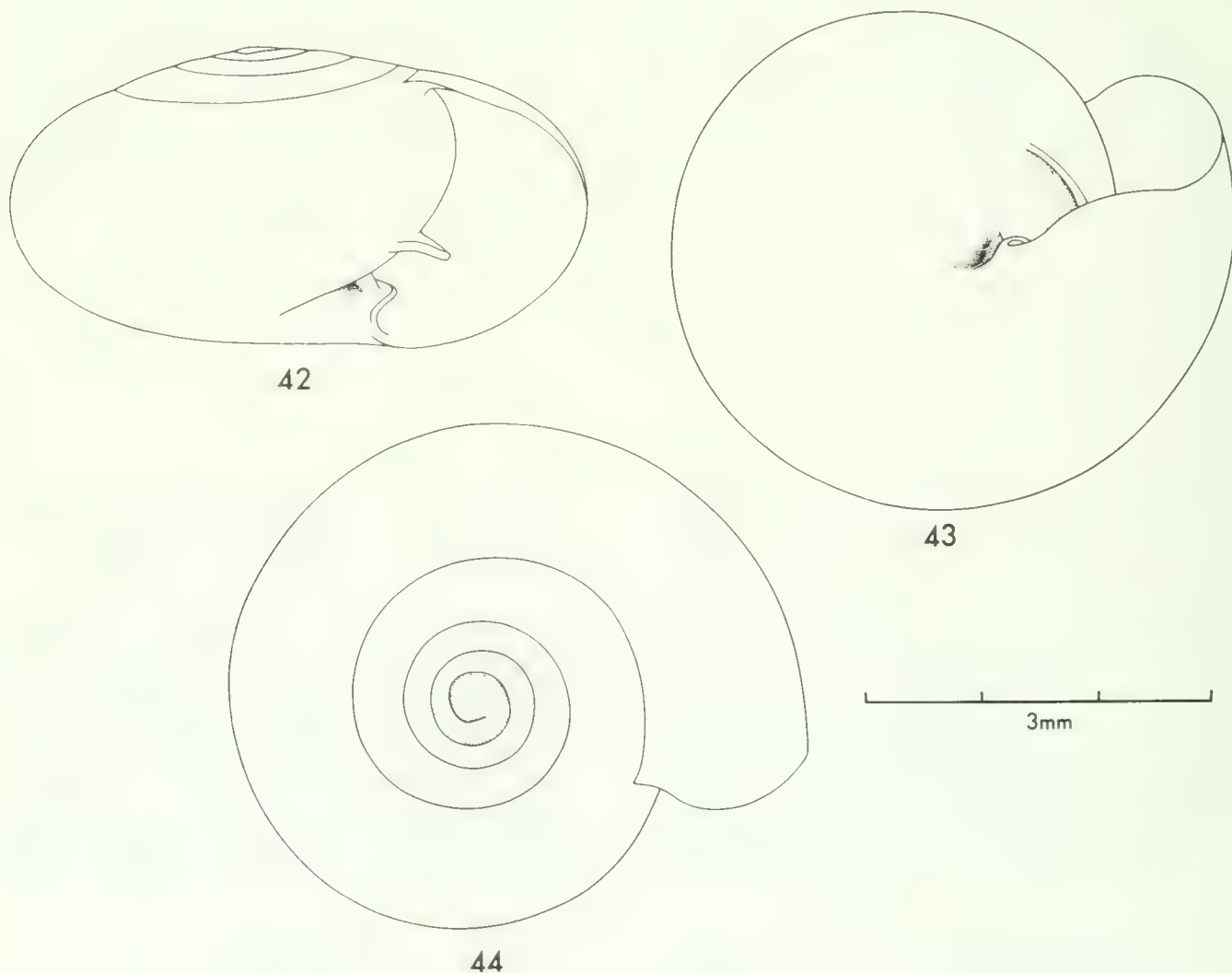

FIGS. 42–44. *Proserpina (Despoenella) marcanoi* Clench (Holotype: MCZ 188911).

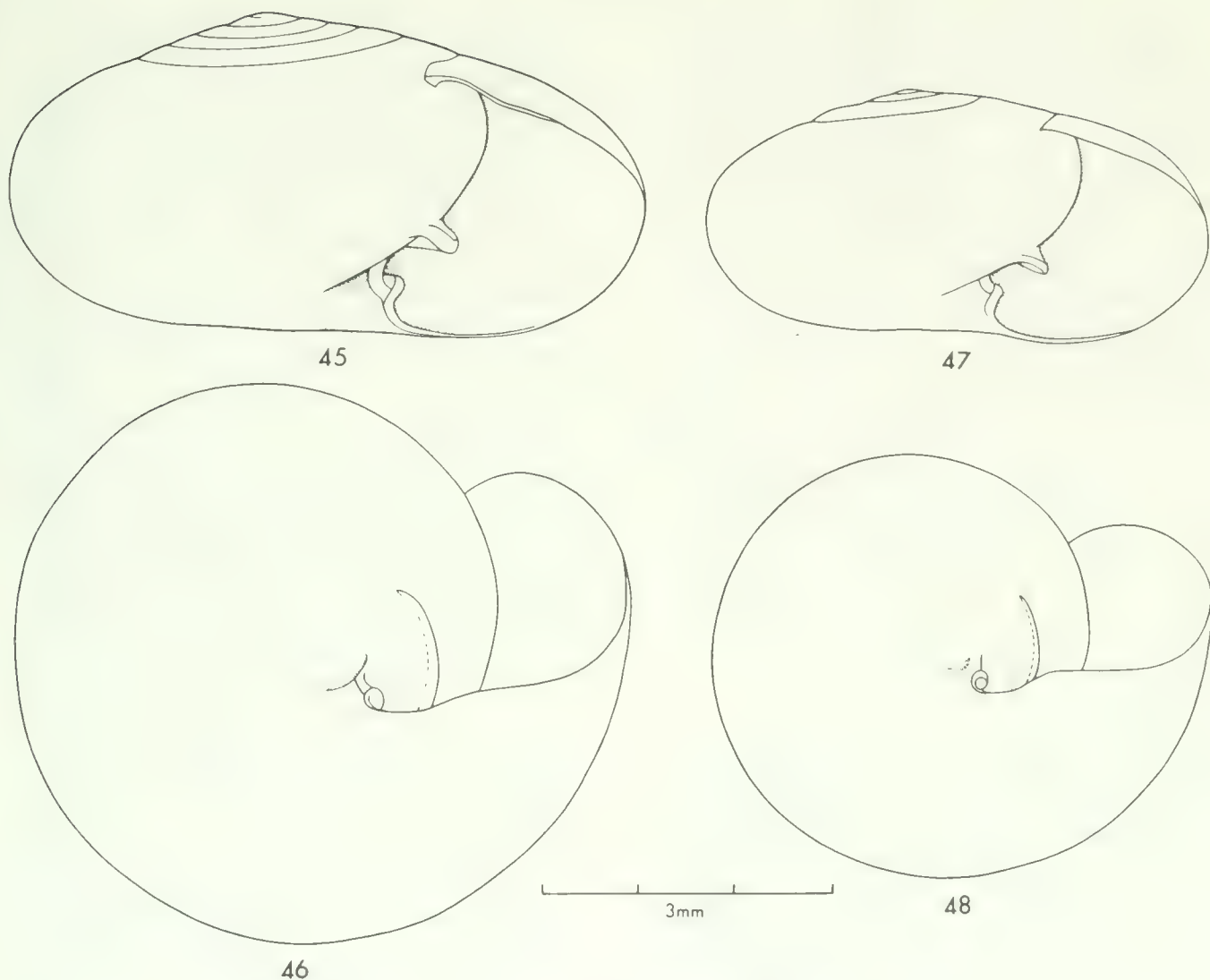

FIGS. 45–46. *Proserpina (Despoenella) depressa* (Orbigny) (UF 24115).  
 FIGS. 47–48. *Proserpina (Despoenella) bidentata* (C. B. Adams) (UF 24114).

known only from the immediate vicinity of Polo, Sierra de Baoruco, Barahona Prov., Dominican Republic. *P. planior* is restricted to the Plateau de Rochellois on the Tiburon Peninsula of Haiti. The area formerly was covered with wet forests on a limestone substrate, but is now reduced to vegetable gardens and a few isolated thickets of brush on limestone outcrops.

The extremely isolated and disjunct ranges of these species indicate relictual distributions for the genus on Hispaniola. Each species is confined to a small geographic area, lying at higher, relatively cool and moist elevations on limestone substrates. I have collected at many other places on Hispaniola that would seemingly comprise suitable habitats for proserpinids, but have not found other populations, in contrast to my experience in Jamaica (1976) where I found proserpinids common in occurrence. Possibly other species occur on Hispaniola, but their discovery will be extremely fortuitous!

*Proserpina (Despoenella) planior* Thompson, *new species*

*Etymology:* *planior*: from the Latin, *planus*, meaning more flattened, alluding to the distinctive shape of this species compared to other *Proserpina*.

*Type-locality:* Haiti, Departement du Sud, Plateau de Rochellois, 22 km SW Miragoâne, 930 m alt. Holotype: UF 26566, collected 31 March 1979 by Fred G. Thompson and Richard Franz; Paratypes: UF 26565 (6); same data as holotype; UF 26564 (10), collected at type-locality 12 May 1979 by Fred G. Thompson and Kurt Auffenberg.

The type-locality is on the south slope of a small knoll covered by a dense thicket of shrubs and small trees. The area once was densely forested but has been cleared for fuel and agriculture. Shells were found among limestone boulders.

*Shell* (Figs. 49–51): *minute*; adults about 3.8–4.5 mm in diameter. Nearly *planispiral*

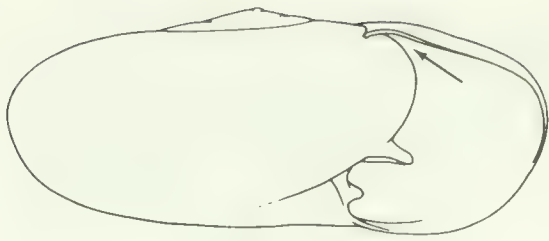

49



52

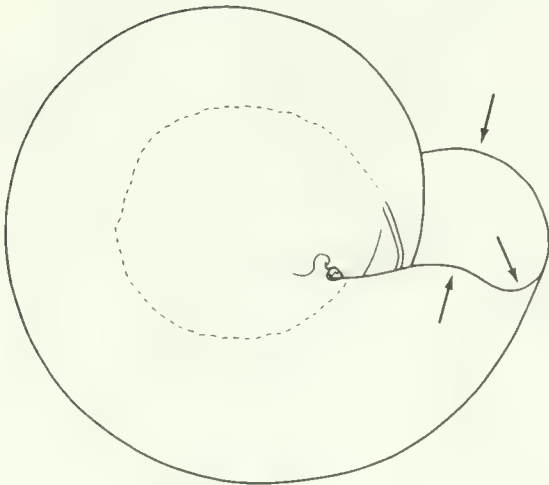

50

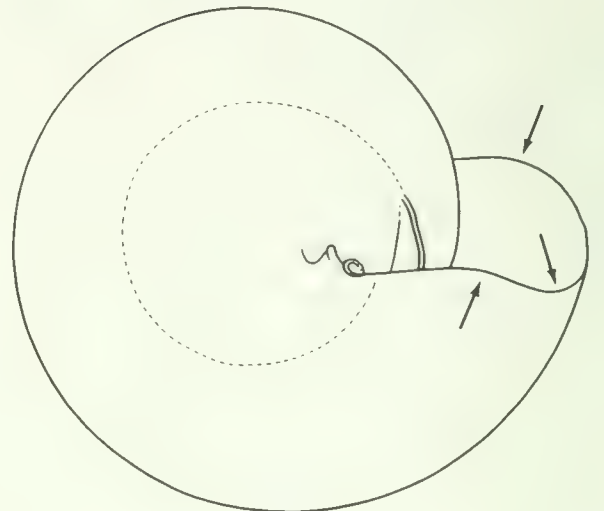

53

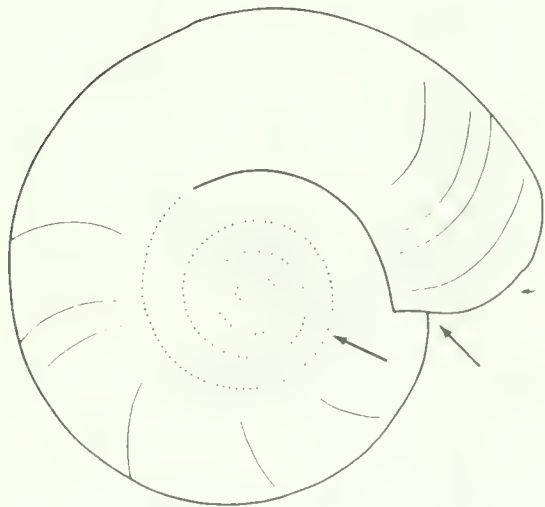

51

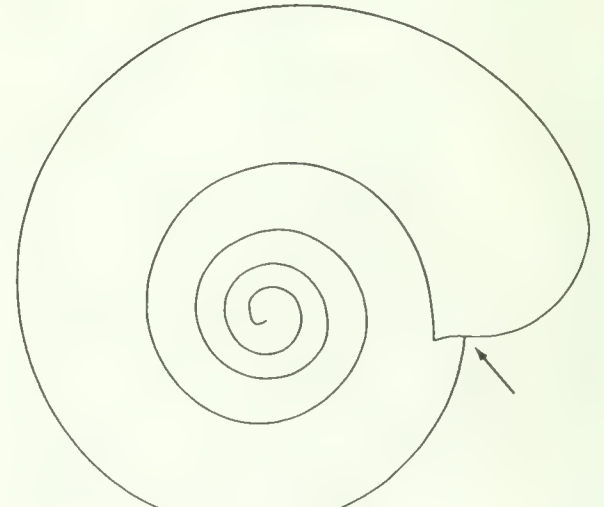

54



FIGS. 49–51. *Proserpina (Despoenella) planior* new species (Holotype: UF 26566).

FIGS. 52–54. *Proserpina (Despoenella) scuderae* new species (Paratype: UF 24327).

(Fig. 49); 0.42–0.46 times as high as wide; apical whorl slightly elevated as a sharp nipple-like protrusion. Light greenish-yellow when fresh, with a spiral white band on apex due to an internal callus along first 2–3 whorls (Fig. 51). Sides and base thin, subtranspar-

ent. Dorsal surface usually opaque due to internal callus and a relatively thick glassy outer deposit that completely covers previous whorls and obscures sutures. Sutural impression apparent only along last two whorls. About 4.3–4.7 whorls in adult specimens (4.3



in holotype). Surface glossy with a few weak incremental wrinkles. Base with weakly granular circum-umbilical callus. Columellar wall near aperture vertical, forming distinct angle or pit just behind columella (Fig. 50). Aperture bluntly angular at periphery and at basolateral margin; baso-columellar angle more distinct; *posterior angle of dorsal lip very narrow and deep due to high insertion of dorsal lip* which lies about halfway between periphery and sutural impression of previous whorl (Fig. 49). *Peristome strongly arched forward along dorsal lip and relatively deeply receded at suture* (Fig. 51); *lateral lip deeply receded at periphery; basal lip conspicuously arched forward, but not as much as dorsal lip* (Fig. 50). Columella slightly oblique. Interior of aperture with parietal and columellar lamellae. Parietal lamella about  $\frac{1}{3}$  whorl long and located at about  $\frac{1}{3}$  distance from columella to periphery. Columellar lamella about  $\frac{1}{2}$  whorl long and relatively low and thin compared to other species.

Measurements in mm based upon seven specimens to show maximum variation in size (holotype in parenthesis): height 1.75–1.97 (1.82); width 3.78–4.46 (4.35); aperture height, 1.54–1.68 (1.68); aperture width, 1.47–1.75 (1.75).

*Distribution:* known only from the type-locality.

*Remarks:* *P. planior* is most closely related to *P. scudderæ*. The two species are similar to each other and differ from all other *Proserpina* by their depressed shapes and protruding apical whorls. They differ by several consistent characters. An immature paratype of *P. scudderæ* (Figs. 52–54), comparable in diameter and whorl count, is illustrated for comparison to the holotype of *P. planior*. *P. planior* is characterized by its small size, attaining a diameter of 3.8–4.5 mm, by its lower number of whorls, 4.3–4.7, and by its depressed, planular shape, being 0.42–0.46 times as high as wide. The dorsal lip is inserted high on the preceding whorl, about halfway between the periphery and the preceding suture, causing the posterior corner of the aperture to be very narrow and deep. The peristome is strongly sinuous with the dorsal and basal lip strongly arched forward and the outer lip strongly receded. The apex bears a spiral white band and an external callus deposit that completely covers the preceding whorls.

Adult *P. scudderæ* are 4.2–5.9 mm in diameter, have 4.5–5.0 whorls and are 0.47–

0.49 times as high as wide. The dorsal lip is inserted about  $\frac{1}{3}$  the distance from the periphery to the suture, causing the posterior angle of the aperture to be broader and shallower. The peristome is not as strongly curved, the apex is unicolor, and the apical callus overlapping the suture extends only about halfway across the preceding whorls.

It may be argued that *P. planior* and *P. scudderæ* should be treated as subspecies because of their similarities. Such a designation requires evidence that they intergrade, which they do not, either morphologically or geographically. The ranges of the two species are disjunct and are separated by a distance of about 300 km. I have collected at about 200 field stations in the intervening territory and have not encountered other populations of *Proserpina*.

#### ACKNOWLEDGMENTS

Many people have aided me in this study. I am grateful to all for their assistance. James Reddell, Texas Technological University, provided me with preserved specimens of *Ceres nelsoni* Dall. Preserved animals of *Proserpina nitida* Sowerby were collected by Glenn Goodfriend. Joseph Rosewater, United States National Museum of Natural History, and Kenneth J. Boss, Museum of Comparative Zoology, loaned me specimens in their charges. Richard Franz, Sylvia Scudder, and Kurt Auffenberg, all of the Florida State Museum, assisted me with field work in Hispaniola. The SEMs, Figs. 5–10, Figs. 31–32, were made by Ms. Scudder. Field work in the Dominican Republic relating to this project was financed by the Florida State Museum. Field work in Haiti during 1979 was financed by the National Geographic Society.

#### LITERATURE CITED

- ADAMS, C. B., 1850a, Descriptions of supposed new species and varieties of terrestrial shells, which inhabit Jamaica. *Contributions to Conchology*, (5): 76–84.
- ADAMS, C. B., 1850b, Descriptions of supposed new species of land shells, which inhabit Jamaica (cont.) *Contributions to Conchology*, (7): 101–108.
- ADAMS, C. B., 1851, Descriptions of new species and varieties of the land shells of Jamaica, with notes on some previously described species. *Contributions to Conchology*, (9): 153–174.

- ADAMS, H., 1870, List of additional species of land and freshwater shells collected by Mr. E. Bartlett in eastern Peru, with descriptions of new species. *Proceedings of the Zoological Society of London*, 1870: 374–377, pl. 27.
- AGUAYO, C. G. & M. L. JAUME, 1947–1951, *Catálogo de los moluscos de Cuba*. Havana: 1–725 (mimeographed).
- AGUAYO, C. G. & M. L. JAUME, 1957, Adiciones a la fauna malacológica Cubana—I. *Memorias de la Sociedad Cubana de Historia Natural*, 23: 117–148.
- ANCEY, C. F., 1892, Descriptions de mollusques nouveaux. *Le Naturaliste*, ser. 2: 178.
- BAKER, H. B., 1922, Notes on the radula of the Helicinidae. *Proceedings of the Academy of Natural Sciences of Philadelphia*, 75: 29–67.
- BAKER, H. B., 1923a, Proserpinidae. *Nautilus*, 36: 84–85.
- BAKER, H. B., 1923b, Notes on the radula of the Neritidae. *Proceedings of the Academy of Natural Sciences of Philadelphia*, 75: 117–178.
- BAKER, H. B., 1925, Anatomy of *Hendersonia*: a primitive helicinid mollusk. *Proceedings of the Academy of Natural Sciences of Philadelphia*, 77: 273–303.
- BAKER, H. B., 1926a, Anatomical notes on American Helicinidae. *Proceedings of the Academy of Natural Sciences of Philadelphia*, 78: 29–56.
- BAKER, H. B., 1926b, The radula of *Proserpina*. *Proceedings of the Academy of Natural Sciences of Philadelphia*, 78: 449–451.
- BAKER, H. B., 1956a, Family names in Pulmonata. *Nautilus*, 69: 128–139.
- BAKER, H. B., 1956b, Family names for land operculates. *Nautilus*, 70: 28–31.
- BLAND, T., 1863, On the Family Proserpinacea with descriptions of a new species of the Genus *Proserpina*. *Annals of the Lyceum of Natural History of New York*, 8: 13–17.
- BLAND, T., 1865, Notes on certain terrestrial Mollusca, with descriptions of new species. *Annals of the Lyceum of Natural History of New York*, 9: 155–170.
- BOSS, K. J., 1972, Minute Jamaican prosobranch gastropods: *Stoastoma* and its congeners. *Breviora*, (393): 1–13.
- BOSS, K. J., 1973, Monograph of *Ceratodiscus* (Archeogastropods; Helicinidae). *Occasional Papers on Mollusks*, 3: 253–379.
- BOSS, K. J. & M. K. JACOBSON, 1975a, Proserpine snails of the Greater Antilles (Prosobranchia; Helicinidae). *Occasional Papers on Mollusks*, 4: 53–90.
- BOSS, K. J. & M. K. JACOBSON, 1975b, Catalogue of the taxa of the subfamily Proserpinidae (Helicinidae; Prosobranchia). *Occasional Papers on Mollusks*, 4: 93–104.
- BOURNE, G. C., 1908, Contribution to the morphology of the group Neritacea of the aspidobranch gastropods.—Part I. The Neritidae. *Proceedings of the Zoological Society of London*, 1908: 810–887, pl. 46–62.
- BOURNE, G. C., 1911, Contributions to the morphology of the group Neritacea of the aspidobranch gastropods.—Part II. The Helicinidae. *Proceedings of the Zoological Society of London*, 1911: 759–809, pl. 30–42.
- CLENCH, W. J., 1962, New species of land mollusks from the República Dominicana. *Breviora*, (173): 1–5.
- DALL, W. H., 1898, A new species of *Ceres* from Mexico. *Nautilus*, 12: 27–28.
- DALL, W. H., 1902, Illustrations and descriptions of new, unfigured, or imperfectly known shells, chiefly American, in the U.S. National Museum. *Proceedings of the United States National Museum*, 24: 499–566.
- DALL, W. H., 1905, A new proserpinoid land shell from Brazil. *Proceedings of the Biological Society of Washington*, 18: 201–202.
- DALL, W. H., 1926, Land shells of the Revillagigedo and Tres Marias Islands, Mexico. *Proceedings of the California Academy of Sciences*, ser. 4, 15: 467–491.
- DUCLOS, [P. L.], 1834, Carocolle. *Carocolle*. Lamarck . . . *Magasin de Zoologie*, 3: classe 5, pl. 30.
- FRETTER, V. & A. GRAHAM, 1962, *British prosobranch molluscs*. Ray Society, London. i–xvi, 1–755.
- GOLIKOV, A. N. & Y. I. STAROBOGATOV, 1975, Systematics of prosobranch gastropods. *Malacologia*, 15: 185–232.
- GRAY, J. E., 1847, A list of the genera of Recent Mollusca, their synonyms and types. *Proceedings of the Zoological Society of London*, pt. 15: 129–219.
- GRAY, J. E., 1856, On the position of the genus *Proserpina* in the system, and a description of its dentition. *Proceedings of the Zoological Society of London*, 29: 99–102.
- IHERING, H. VON, 1877, *Vergleichende Anatomie des Nervensystems und Phylogenie der Mollusken*. Leipzig, p. 1–290.
- ISENKRAHE, C., 1867, Anatomie von *Helicina titanica*. *Archiv für Naturgeschichte*, 33: 50–72, figs. 1–11.
- JOUSSEAUME, F., 1887, Mollusques nouveaux de la République de l'Equateur. *Bulletin de la Société Zoologique de France*, 12: 165–186, pl. 3.
- JOUSSEAUME, F., 1889, Mollusques du Venezuela (Voyage du M. Eugene Simon). *Mémoires de la Société Zoologique de France*, 2: 232–259, pl. 9.
- KEEN, A. M., 1960, in *Treatise on Invertebrate Paleontology: Mollusca 1*, Pt. 1: i–xxiii, 1–351, Lawrence, Kansas.
- KOBELT, W., 1879, *Illustriertes Conchylienbuch*. Nürnberg. 2: 1–264.
- MARTENS, E. VON, 1890–1901, *Biologia Centrali-Americana: Land and Freshwater Mollusca*. London. i–xxviii, 1–709.
- MILLER, K., 1878–1879, Die Binnenmollusken von Ecuador. *Malakozoologische Blätter*, 25: 153–199, pl. 7–8; n.s., 1: 117–199, pl. 4–15.

- NEWTON, R. B., 1891, *Systematic list of the British Oligocene and Eocene Mollusca in the British Museum (Natural History)*. London. 1-365.
- ORBIGNY, A., 1842, Mollusques, in SAGRA, R., *Histoire physique, politique et naturelle de l'île de Cuba*. Paris, 2: 1-264.
- PFEIFFER, L., 1848, *Monographia heliceorum viventium*. 1: i-xxxii, 1-484. Leipsig.
- PFEIFFER, L., in MARTINI & CHEMNITZ, 1850, Systematisches Conchyliencabinet, Die Familie Heliceen. 12: 1-524, pl. 1-161.
- PFEIFFER, L., 1853, *Monographia heliceorum viventium*. 3: i-viii, 1-711. Leipsig.
- PFEIFFER, L., 1856, Descriptions of twenty-seven new species of land snails collected by M. Salle in the State of Veracruz, Mexico. *Proceedings of the Zoological Society of London*, 24: 318-324, pl. 35.
- PFEIFFER, L., 1876, *Monographia pneumonopomorum viventium*. 4: i-x, 1-479.
- PILSBRY, H. A. & A. BROWN, 1910, The Mollusca of Mandeville, Jamaica, and its environs. *Proceedings of the Academy of Natural Sciences of Philadelphia*, 62: 510-535.
- SIMROTH, H., 1896-1907, H. G. BRONN's *Klassen und Ordnungen des Tier-Reichs*, 3(2). *Mollusca: Prosobranchia*, 1-1056.
- SIMROTH, H., 1910, Some remarks with regard to Professor Bourne's monograph on the Neritidae. *Proceedings of the Zoological Society of London*, 1910: 27-33.
- SOLEM, A., 1954, Notes on Mexican mollusks. I. Durango, Coahuila and Tamaulipas, with descriptions of two new *Humboldtiana*. *Nautilus*, 68: 3-10.
- SOWERBY, G. B., II, 1839, *A conchological manual*. London, i-v, 1-130.
- STREBEL, H., 1873, Beitrag zur Kenntniss der Fauna Mexikanischer Land- und Susswasser Conchylien. 1: 1-69, 7 pl. Hamburg.
- SYKES, E. R., 1900, On *Despoena cinnanomea*, n. sp., and type of a new subgenus, *Chersodespoena*, with notes on some allied forms. *Proceedings of the Malacological Society of London*, 4: 136-138.
- TAYLOR, D. W. & N. F. SOHL, 1962, An outline of gastropod classification. *Malacologia*, 1: 7-32.
- THIELE, J., 1902, Die systematische Stellung der Solenogastren und die Phylogenie der Mollusken. *Zeitschrift für wissenschaftliche Zoologie*, 72: 249-466.
- THIELE, J., 1910, Über die Anatomie von *Hydocena catoroensis* Pf. *Abhandlungen der Senckenbergischen Naturforschenden Gesellschaft*, 32: 351-358.
- THIELE, J., 1927, Über die Gattung *Ceratodiscus*. *Archiv für Molluskenkunde*, 59: 155-157.
- THIELE, J., 1931, *Handbuch der systematischen Weichtierkunde*: 1: i-vii, 1-778, Stuttgart.
- THOMPSON, F. G., 1967, A new land snail of the family Proserpinidae from Chiapas, Mexico (Gastropoda: Prosobranchia). *Proceedings of the Biological Society of Washington*, 80: 61-64.
- WENZ, W., 1938-1944, *Handbuch der Paläozoologie*: Band 6—Gastropoda, Teil 1: i-xii, 1-639. Berlin.



## THE ABUNDANCE, DISTRIBUTION AND DIVERSITY OF THE MOLLUSCS OF WESTERN PORT, VICTORIA, AUSTRALIA<sup>1</sup>

N. Coleman<sup>2</sup> and W. Cuff<sup>3</sup>

### ABSTRACT

The mollusc fauna of Western Port, Victoria, Australia (145°20'E; 38°20'S) is described. Between 1973 and 1975, samples were taken according to a stratified random sample design and were used to give regional and bay-wide estimates of mollusc distribution, abundance and diversity. Faunal affinity analysis, using both presence-absence and abundance data, was used to define major faunal assemblages. Fauna-sediment associations were investigated using non-parametric rank correlation tests.

More than 1800 individuals belonging to 96 species were collected. Most individuals and species were bivalves. Gastropods were next in abundance, then polyplacophorans and cephalopods. Species providing 2% or more of the individuals were considered dominant. The fourteen dominant species (1 gastropod, 13 bivalves) together provided 82.4% of the individuals collected.

Affinity analysis showed two major faunal assemblages the distributions of which are related to sediment type. Several stations, all situated near the boundaries of different sediment types, showed a particularly wide range of affinities but were assigned to one or other of the assemblages according to their strongest affinities.

One assemblage is associated with medium to coarse, mud-free sand and is distributed mainly in the deeper (>5.5 m) channel areas. Dominant species are the suspension-feeding gastropod *Sigapatella calyptraeformis* and the suspension-feeding bivalves *Lissarca rubricata*, *Neotrigonia margaritacea*, *Venericardia bimaculata*, *Lepton frenchiensis*, *Notocallista diemenensis* and *Gomphina undulosa*. The surface deposit-feeding bivalve *Tellina mariae* also appeared as a dominant because of its abundance at one station in the assemblage.

The other assemblage is associated with fine sand and mud and is found in shallow sublittoral (<5.5 m) and intertidal areas. Dominant species are the suspension-feeding bivalves *Micromytilus francisensis*, *Cyclopecten favus*, *Lepton frenchiensis*, *Mysella donaciformis* and *Katelsysia rhytiphora*, and the surface deposit-feeding bivalves *Pronucula concentrica*, *Tellina deltoidalis* and *Tellina mariae*. Although *Lepton frenchiensis* and *Tellina mariae* were dominant in both assemblages, they were most widespread in and characteristic of this 'fine sand and mud' assemblage.

The mollusc fauna of the coarser, mud-free sediments has a greater number of species, higher species diversity and, particularly amongst the epifauna, a greater abundance of suspension-feeders than that of the fine and muddy sediments.

### INTRODUCTION

Victoria has a rich mollusc fauna (listed in Macpherson & Gabriel, 1962). Nevertheless, there is little detailed information on the abundance and distribution of species. Qualitative surveys have been made in Port Phillip (Burn, 1966; Macpherson, 1966; King et al., 1971) and Western Port (Smith, 1971; Watson, 1971), two bays adjacent to Melbourne, but previous quantitative data are restricted to one bay-wide survey of Port Phillip (Poore & Rainer, 1974) and one of a small area of

Western Port (Coleman, 1976). During 1973–1974 a survey of the macrobenthos of Western Port was undertaken as part of an environmental study (Ministry for Conservation, 1975; Coleman et al., 1978; Cuff & Coleman, 1979). The survey included the greater part of the bay, and in 1975 samples were taken in those areas not sampled during 1973–1974. This paper describes the abundance, distribution and sediment preferences and diversity of the molluscan fauna of Western Port as shown by the samples taken between 1973 and 1975.

<sup>1</sup>Paper No. 216 in the Ministry for Conservation, Environmental Studies Series

<sup>2</sup>Marine Science Laboratories, P.O. Box 114, Queenscliff, Victoria 3225, Australia

<sup>3</sup>Division of Computing Research, CSIRO, P.O. Box 1800, Canberra, A.C.T. 2601, Australia

## METHODS

## Survey area

Western Port (Fig. 1) is a marine embayment about 60 km SE of Melbourne. Its total area is approximately 1450 km<sup>2</sup>, but because of French and Phillip Islands the water surface area is only 680 km<sup>2</sup> of which about 40% (270 km<sup>2</sup>) is intertidal. The bay is morphologically complex and includes salt marsh, mangroves, beaches, intertidal rock platforms, tidal flats, subtidal rocky areas, subtidal embayment plains and tidal channel systems (Marsden & Mallett, 1975; Smith et al., 1975).

The sediment of the channels of North and East Arms is predominantly medium to coarse sand<sup>4</sup> with less than 5% mud. These sediments are moderately well sorted<sup>4</sup> but sorting becomes poorer with greater mean grain size. The sediment of the shallow sublittoral areas and of the intertidal flats is fine sand and mud. Mean grain size is smaller than for the channel sediments and sorting is poorer (Marsden & Mallett, 1975).

Seagrasses and algae are found throughout the bay. The more exposed areas of the tidal flats support a vegetation chiefly of the

seagrass *Zostera muelleri* and *Heterozostera tasmanica*. On the muddy channel edges and in shallow sublittoral areas the vegetation is mostly a mixture of *H. tasmanica* and the green alga *Caulerpa cactoides* plus smaller quantities of other green, brown and red algae. In the deep portions of North and East Arms, turbidity reduces light penetration and plant life is virtually absent (Ministry for Conservation, 1975; Smith et al., 1975).

Temperature, salinity and dissolved oxygen in the bay were recorded during 1973–1974 (Ministry for Conservation, 1975). An annual range of 10–22°C was recorded from the water in the shallowest areas of the bay, to the northeast of French Island. The range was less in areas of deeper water, being 13–20°C in Bass Strait. Annual temperatures recorded from sediments exposed to the air at low tide ranged from 8–27°C at the surface and from 9–29°C at a depth of about 10 cm. Although a number of rivers and streams enter the bay, the effects of freshwater influx were only local. Salinity varied between 30 and 38‰ and was highest in the late summer. The waters of the bay were generally about 100% saturated with dissolved oxygen, but supersaturation (to 195%) occurred where photosynthesis by

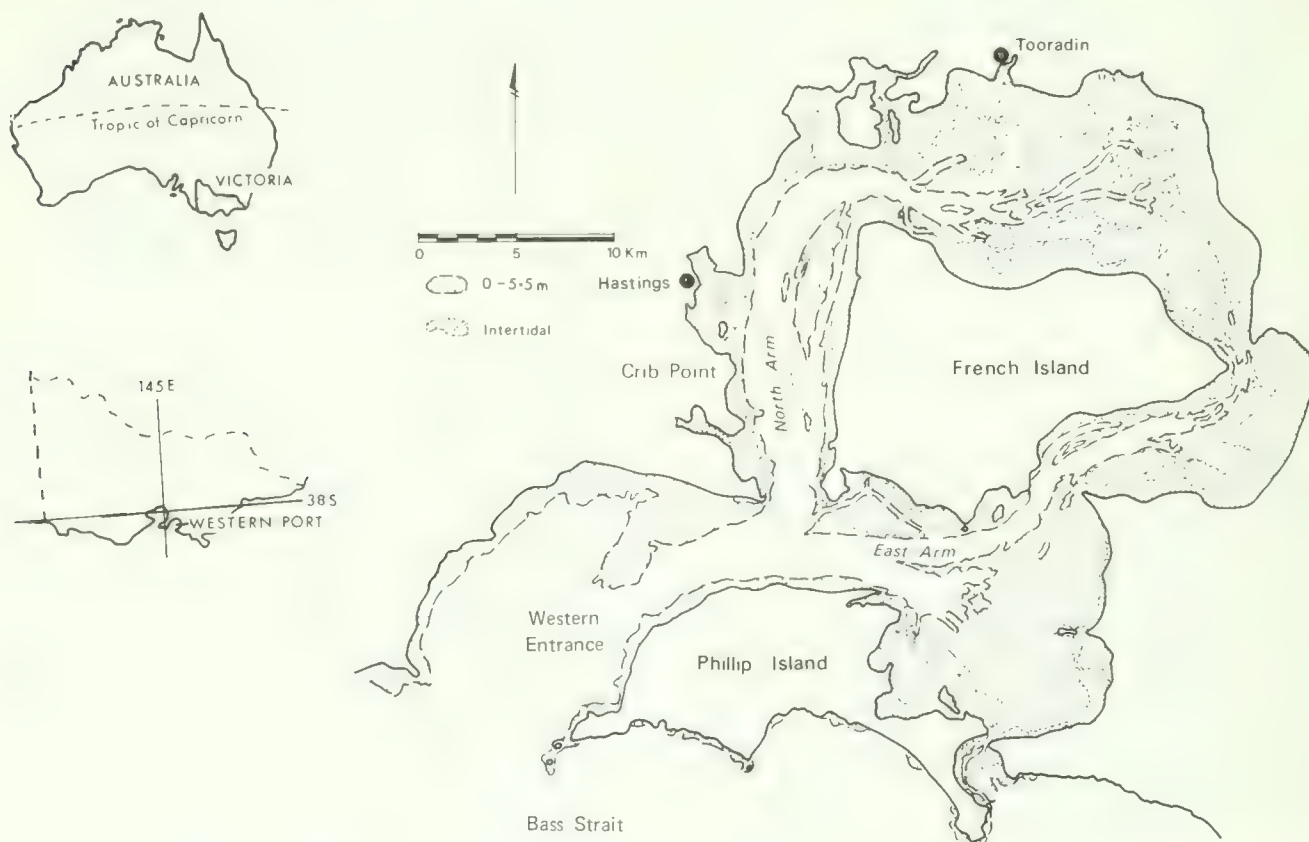

FIG. 1. Location and General Features of Western Port, Victoria, Australia.

<sup>4</sup>See section on sediment analysis for definition of terms.

seagrass was vigorous, and depletion (to 80%) occurred in areas where there was decomposing seagrass.

### Survey design

The survey design was that of stratified random sample with approximately proportional allocation of samples to strata. Such a design is easy to implement; allows unbiased estimates of species richness (number of species present), abundance (number of individuals of each species) and distribution; and provides both regional and universe estimates (Wadley, 1952; Southwood, 1966; Weber, 1973; Cuff & Coleman, 1979).

A map of Western Port was divided into three areas corresponding to intertidal, shallow (<5.5 m) and deeper (>5.5 m) sublittoral areas. These areas were subdivided, on the basis of sediment type, as then known (from aerial photographs and from local boatmen), and location within the bay, into eleven strata

(Fig. 2). The area of each stratum was estimated and each was allocated a number of stations approximately proportional to its area. Fifty stations, numbered 1701–1750 in accordance with the Marine Studies Group numbering system, were selected, using a random number table to generate grid coordinates, and were allocated to strata as shown in Fig. 2. Stratum 4 was not sampled because physical condition (shallowness, heavy swell, surf breaking on shallow banks) in this region made sampling impossible. Stratum 11 was not sampled because proportional allocation gave it much less than one station. The numbers of stations allocated to strata 1, 2, 3, 5, 6, 7, 8, 9 and 10 were 8, 4, 8, 6, 2, 2, 2, 1 and 17 respectively.

### Collection and treatment of samples

All stations were sampled during the summer. Subtidal stations were sampled from a

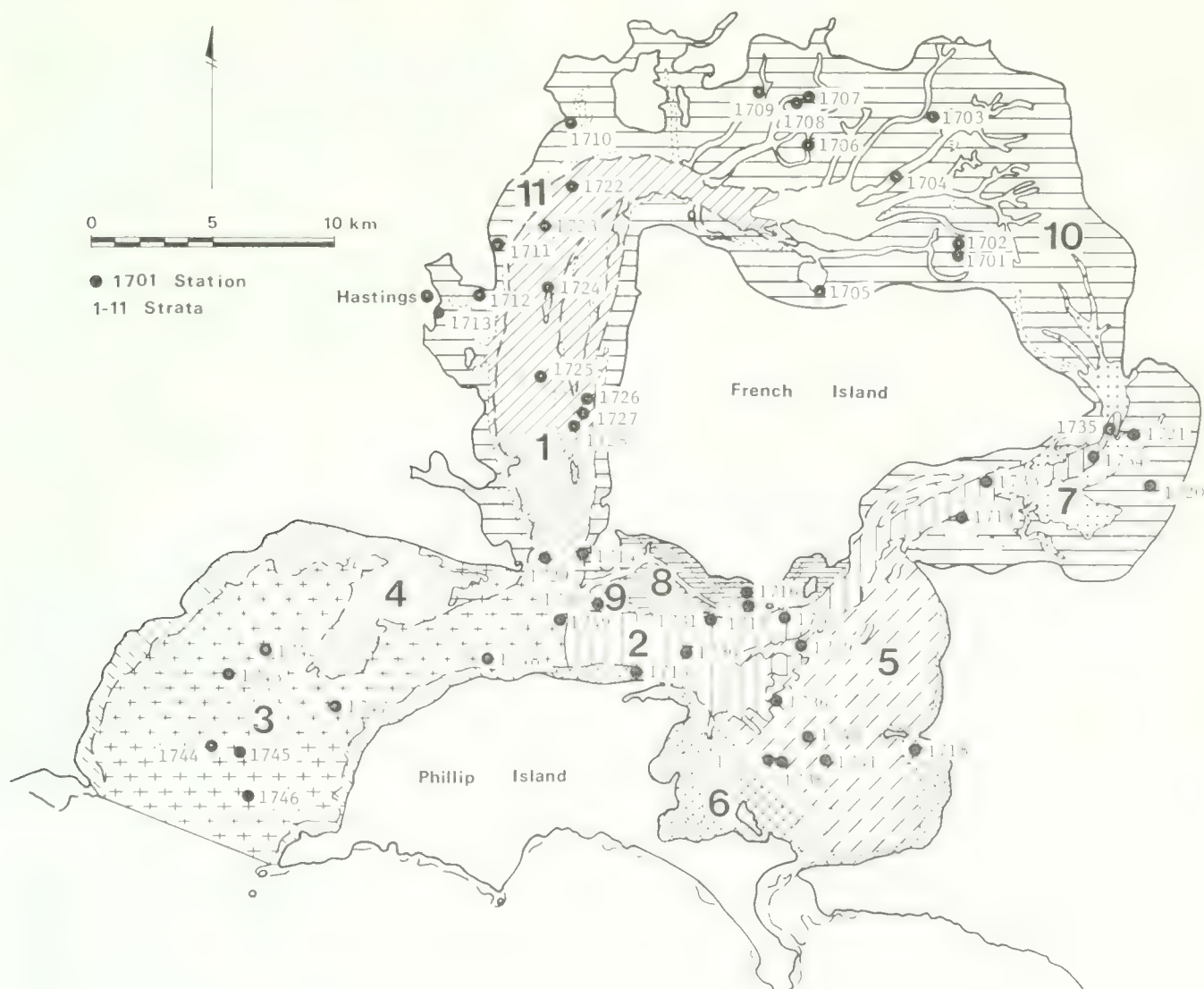

FIG. 2. Strata defined and stations sampled in Western Port.

research vessel which carries radar capable of locating sample sites to within  $\pm 30$  m. Stations 1706 and 1721–1741 were sampled in November 1973. The Western Entrance stations, 1742–1750, were sampled in November 1975.

The intertidal stations, 1701–1705 and 1707–1720, were sampled in January 1974. Sampling was carried out at high tide from a shallow-draught barge. The barge was in radio contact with the research vessel and was positioned by use of the latter's radar.

At each station three samples were taken with a 0.1 m<sup>2</sup> Smith-McIntyre benthic grab. About 50 g of the collected sediment was removed for granulometric analysis and the remainder was washed through a sieve with an aperture of 1.003 mm (mesh no. 16 to BS410:1962). The material retained on the sieve was preserved with 5% neutral formalin and taken to the laboratory.

In the laboratory, samples were placed in shallow plastic trays, sorted and the animals removed. The portions composed of small particles were placed under an illuminated magnifier or stereomicroscope for sorting. The specimens removed from the samples were counted and identified. Where there was doubt as to whether a mollusc was collected alive or dead the specimen was identified and the shell was then crushed and the presence or absence of the animal determined.

#### Analysis of data

For the analyses described in this paper, the three grab samples per station were lumped. Total numbers of individuals and species per station were determined, and species were assigned to feeding types on the basis of information in the literature (Morton, 1958; Macpherson & Gabriel, 1962; Poore & Rainer, 1974).

The Shannon-Wiener diversity index,  $H'$ , was calculated as

$$H' = - \sum_{i=1}^s p_i \ln p_i$$

where  $p_i$  is the proportion of individuals represented by the  $i$ th of  $s$  species.

Evenness,  $J'$ , was calculated as

$$J' = \frac{H'}{\ln s}$$

where  $H'$  is the Shannon-Wiener diversity index and  $s$  is the number of species.

Using binary (i.e. presence-absence) data, faunal affinity between stations was calculated by comparing all possible pairs of stations according to Czekanowski's formula (Czekanowski, 1913; Clifford & Williams, 1976)

$$2a/(2a + b + c)$$

where  $a$  is the number of species common to both stations,  $b$  is the number of species present at the first station only and  $c$  is the number of species present at the second station only.

Faunal affinity values were converted to dissimilarity (1-formula) and stations fused using a flexible sorting strategy with  $\beta = -0.25$  (Lance & Williams, 1967; Clifford & Stephenson, 1975).

Using abundance data, faunal affinity was calculated by the Canberra Metric Dissimilarity Measure

$$\frac{1}{m} \sum_k \frac{|X_{ik} - X_{jk}|}{X_{ik} + X_{jk}}$$

where  $m$  is the number of species in the samples being compared,  $X_{ik}$  is the number of individuals of the  $k$ th species in the  $i$ th station and  $X_{jk}$  similarly for the  $j$ th station. Stations were fused using a flexible sorting strategy with  $\beta = -0.25$  (Lance & Williams, 1967; Clifford & Stephenson, 1975).

Affinity analysis indicated two faunal assemblages. Average values for the sediment and faunal characteristics of these assemblages were tested for significant differences ( $p < 0.05$ ) by  $t$  tests. Where variances were not initially homogeneous, tested by the  $F_{\max}$  test (Sokal & Rohlf, 1969), logarithmic transformations made them so and the transformed data were used.

Tests between assemblages are only approximate as the data for an assemblage do not represent a simple random sample from the population of samples per assemblage. Statistically valid tests of differences between strata were made using one-way analysis of variance tests (Sokal & Rohlf, 1969). Variances were tested for homogeneity by Bartlett's test (Sokal & Rohlf, 1969) and, where necessary, logarithmic transformation was used.

Fauna-sediment associations were investigated by non-parametric tests. The Kendall rank correlation coefficient,  $\tau$  (tau) (Siegel, 1956), was calculated for associations between fauna and sediment mean grain size, mud content, sorting and skewness. Where



associations with two of the investigated sediment characteristics were significant ( $p < 0.05$ ), Kendall partial rank correlations,  $\tau_{xy \cdot z}$  were calculated. The partial rank correlations cannot be tested for significance, but the magnitude of changes in the rank correlation coefficients when the effects of particular factors are removed gives some indication of the importance of these factors (Siegel, 1956).

#### Sediment analysis

Sediments were analysed at the University of Melbourne (Marsden & Mallett, 1974, 1975). Grain size was measured on the  $\phi$  scale ( $\phi = -\log_2$  diameter in mm, of sediment particle). Values for  $\phi$  increase as grain size decreases, thus coarse sand = 0–1  $\phi$ , medium sand = 1–2  $\phi$ , fine sand = 2–3  $\phi$ , very fine sand = 3–4  $\phi$ , silt = 4–8  $\phi$  and clay = 8–12  $\phi$ .

For each sample the sand and mud (= silt + clay) fractions were separated by wet sieving. Size analysis of the sand was by sieving. Pipette analysis of the mud was used to differentiate silt and clay. Size analysis data were plotted as cumulative per cent by weight against grain size. Percentile values were obtained and used to calculate mean grain size ( $(\phi_{16} + \phi_{50} + \phi_{84})/3$ ); sorting ( $(\phi_{84} - \phi_{16})/4 + (\phi_{95} - \phi_5)/6.6$ ), values of which increase as sorting, a measure of clustering of grain size around the mean, becomes poorer; and skewness ( $(\phi_{16} + \phi_{84} - 2\phi_{50})/2(\phi_{84} - \phi_{16}) + (\phi_5 + \phi_{95} - 2\phi_{50})/2(\phi_{95} - \phi_5)$ ) (Folk, 1968).

TABLE 2. Values (mean  $\pm$  SD per station) for sediment and mollusc fauna characteristics bay-wide and in the molluscan assemblages recognised in Western Port. cmsa = clean medium sand assemblage; fsma = fine sand and mud assemblage. Asterisks denote significant differences ( $p < 0.05$ ) between assemblages.

Mean $\pm$ SD/station for:	Bay-wide	cmsa	fsma	Probability
Mean grain size, $\phi^1$		1.47 $\pm$ 0.57	2.47 $\pm$ 1.24	<0.01*
% Mud in substratum		2.97 $\pm$ 14.93	40.95 $\pm$ 37.64	<0.01*
Sorting		0.89 $\pm$ 0.54	1.25 $\pm$ 0.71	0.08
No. of individuals	36.9 $\pm$ 44.3	38.0 $\pm$ 42.7	35.9 $\pm$ 46.6	0.16
No. of species	5.8 $\pm$ 4.9	7.6 $\pm$ 5.6	4.2 $\pm$ 3.5	0.01*
Species diversity, H'	1.01 $\pm$ 0.66	1.23 $\pm$ 0.72	0.81 $\pm$ 0.53	0.02*
Evenness, J'	0.70 $\pm$ 0.19	0.71 $\pm$ 0.23	0.69 $\pm$ 0.15	0.12
No. of infaunal suspension-feeders	15.9 $\pm$ 20.3	20.2 $\pm$ 20.4	11.8 $\pm$ 19.6	0.14
No. of epifaunal suspension-feeders	6.3 $\pm$ 16.6	9.7 $\pm$ 21.8	3.1 $\pm$ 9.2	0.02*
Total No. of suspension-feeders	22.4 $\pm$ 27.1	29.9 $\pm$ 30.6	14.9 $\pm$ 21.5	0.05*
No. of surface deposit-feeders	11.2 $\pm$ 26.7	4.7 $\pm$ 18.7	18.2 $\pm$ 31.6	0.07
No. of grazers	2.1 $\pm$ 3.6	2.3 $\pm$ 3.0	1.9 $\pm$ 4.0	0.28
No. of predators	0.8 $\pm$ 1.7	0.8 $\pm$ 1.6	0.8 $\pm$ 1.8	0.09
No. of scavengers	0.2 $\pm$ 0.7	0.3 $\pm$ 0.8	0.1 $\pm$ 0.4	0.20

<sup>1</sup> $\phi$  values increase as grain size decrease

## RESULTS

### Bay-wide estimates of mollusc abundance, diversity and distribution

Eighteen hundred and forty-three individuals belonging to 95 species were collected (Table 1). Bivalves predominated both as individuals and as species. Next in abundance were gastropods which, although not highly abundant in terms of individuals, did provide a relatively high proportion of the species collected. Chitons and cephalopods were poorly represented in the samples and no scaphopods were found.

The number of individuals per station (Fig. 3; Table 2) ranged from 1 to 208 with a mean of 36.9. Species per station ranged from 1 to 22 with a mean of 5.8. Species diversity ranged from 0 (at stations with only 1 species) to 2.49 with a mean of 1.01. Evenness ranged from 0.39 to 1.00 with a mean of 0.72.

Most of the individuals and species collected were suspension-feeders (Fig. 3; Table 2). Surface deposit-feeders were also com-

TABLE 1. Numbers of individuals and species of molluscs collected in the Western Port survey.

Class	No. of individuals	% of all individuals	No. of species	% of all species
Polyplacophora	33	1.8	5	5.2
Gastropoda	198	10.7	40	42.1
Bivalvia	1606	87.1	50	51.6
Cephalopoda	6	0.3	1	1.1

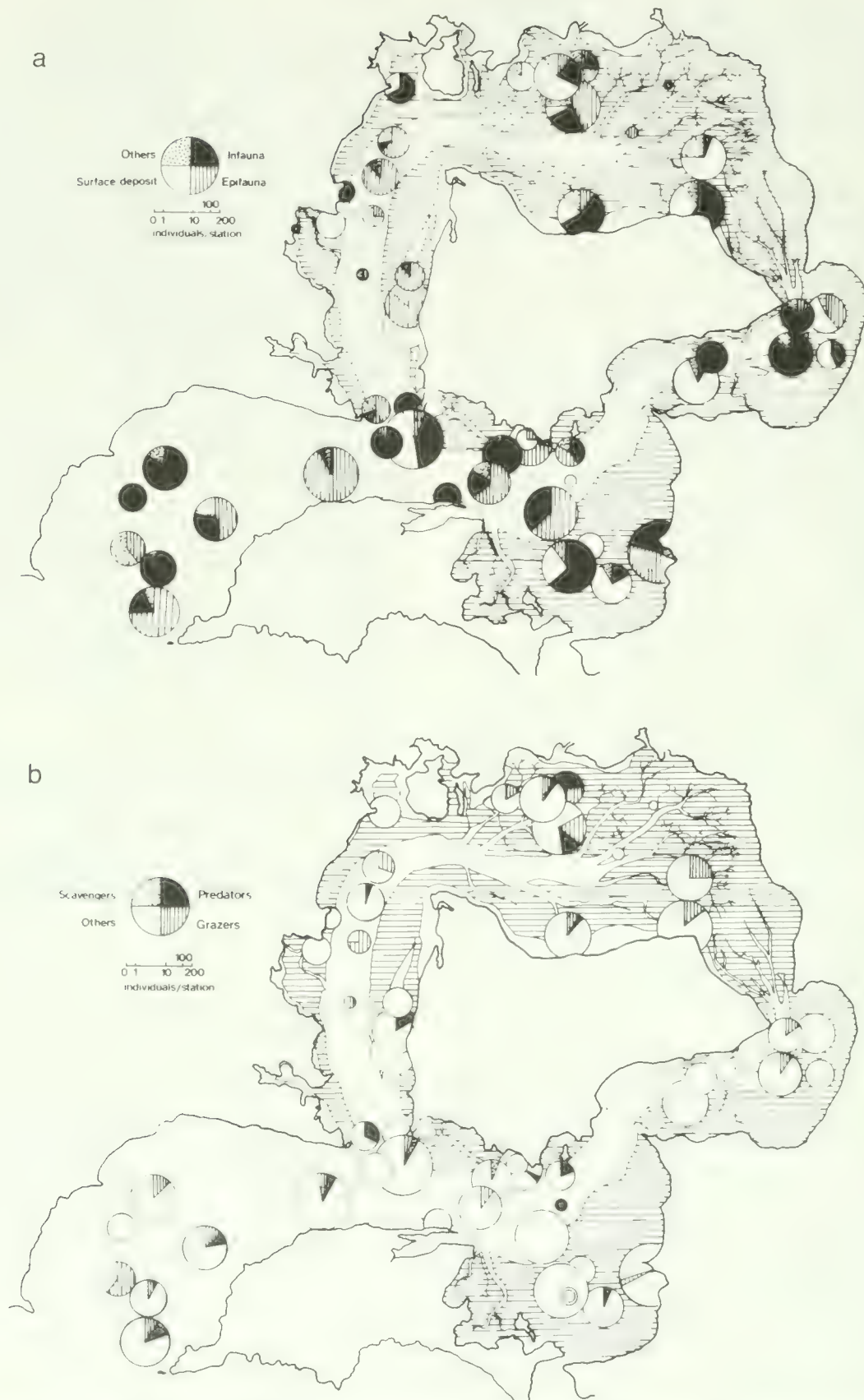

FIG. 3. Number of mollusc individuals and proportion of different feeding types at the sample stations. Circle diameter indicates total number of individuals per station, segment sizes indicate proportions of different feeding types. Clear areas are predominantly deep (>5.5 m) areas with a sediment of medium to coarse sand and little mud (< 5%). Hatched areas are predominantly shallow (<5.5 m) or intertidal with a sediment of fine sand and mud.

Fig. 3a. Infauna = infaunal suspension feeders; Epifauna = epifaunal suspension feeders; Surface deposit = surface deposit feeders; Others = molluscs of other feeding types.

Fig. 3b. Predators = predatory molluscs; Grazers = grazing molluscs; Scavengers = scavenging molluscs; Others = molluscs of other feeding types.

mon, providing about a third of the individuals collected but only 3% of species. Grazers, predators and scavengers together accounted for only 8% of individuals but for 48% of species.

Species which provided 2% or more of the individuals collected were considered dominant (following Bandy, 1958). On a bay-wide basis 14 (14.6%) of the 96 species were dominant, and provided 82.4% of the individuals. Most of the dominant species and individuals were suspension-feeders, but the single most abundantly collected species was the surface deposit-feeder *Tellina mariae* which contributed almost a fifth of the molluscs collected (Table 3).

Some dominant species (e.g. *Micromytilus francisensis*, *Gomphina undulosa*—Fig. 4) occurred at only a few stations, owing their dominance to their relatively high numbers at these stations. Other dominant species were more widespread, though they occurred less abundantly at any one station (Figs. 4–8; Table 3).

#### Faunal affinity between stations

A trellis diagram of faunal affinity calculated from presence-absence data shows two major groups of stations (Fig. 9). Group 1 con-

tains all the stations from strata 2, 7 and 9, most from stratum 1, half from stratum 3 and one each from strata 5 and 10. These stations are in the deeper (>5.5 m) channel areas or immediately adjacent shallows where the sediment is largely medium sand (Tables 2, 5). This station group and its associated mollusc fauna has therefore been characterised as a 'clean medium sand assemblage' (cmsa). Group 2 contains all the stations from strata 6 and 8, most from strata 5 and 10 and one from stratum 1. These stations are mostly from shallow sublittoral (<5.5 m) and intertidal areas of fine sand and mud and they, and their molluscan fauna, are characterised as a 'fine sand and mud assemblage' (fsma).

A few stations (e.g. 1708, 1736, 1750), situated near the boundaries between sediment types, show a particularly wide range of affinities but are placed in one or other of the major groups according to their strongest affinities. Stations 1747, 1727, 1742, 1707, 1739, 1743, 1745, 1703 and 1713 (Fig. 9) show a restricted range of affinities and do not appear as an integral part of either major group. The affinities of 1747, 1742, 1707, 1743 and 1745 are highest with those stations forming the cmsa (Fig. 9, Group 1), and are considered as part of that assemblage. Stations 1727, 1739, 1703 and 1713 show their

TABLE 3. Dominant mollusc species in the Western Port benthic survey. ES – epifaunal suspension feeder; IS – infaunal suspension feeder; SD – surface deposit feeder; cmsa = clean medium sand assemblage; fsma = fine sand and mud assemblage; c – species characteristic of cmsa; f – species characteristic of fsma.

Species	Feeding type	No. of individuals as % of:			No. of stations at which found as % of:		
		all mollusc individuals	molluscs in cmsa	molluscs in fsma	all stations sampled	stations in cmsa	stations in fsma
<i>Sigapatella calyptraeformis</i>	c ES	4.0	7.5	0.2	30	58	3
<i>Lissarca rubricata</i>	c ES	6.4	12.7	0.2	14	25	3
<i>Neotrigonia margaritacea</i>	c IS	2.9	5.8	0	24	50	0
<i>Venericardia bimaculata</i>	c IS	3.2	6.4	0	22	46	0
<i>Notocallista diemenensis</i>	c IS	6.9	13.8	0.1	20	37.5	3.8
<i>Gomphina undulosa</i>	c IS	3.4	6.9	0	6	12.5	0
<i>Solen vaginoides</i>	c IS	4.4	9.0	0	18	37.5	0
<i>Pronucula concentrica</i>	f SD	4.9	1.2	8.6	22	16.6	26.9
<i>Micromytilus francisensis</i>	f ES	2.7	0	5.4	6	0	11.5
<i>Cyclopecten favus</i>	f ES	(1.5)	0.3	2.6	10	4.2	15.4
<i>Lepton frenchiensis</i>	f IS	6.0	6.1	5.9	18	4.2	30.8
<i>Mysella donaciformis</i>	f IS	4.8	0.4	9.0	18	4.2	30.8
<i>Katelsia rhytiphora</i>	f IS	5.5	1.0	9.9	24	8.3	38.5
<i>Tellina deltoidalis</i>	f SD	8.0	0	15.9	14	0	26.9
<i>Tellina mariae</i>	f SD	19.3	9.3	29.1	32	8.3	53.9

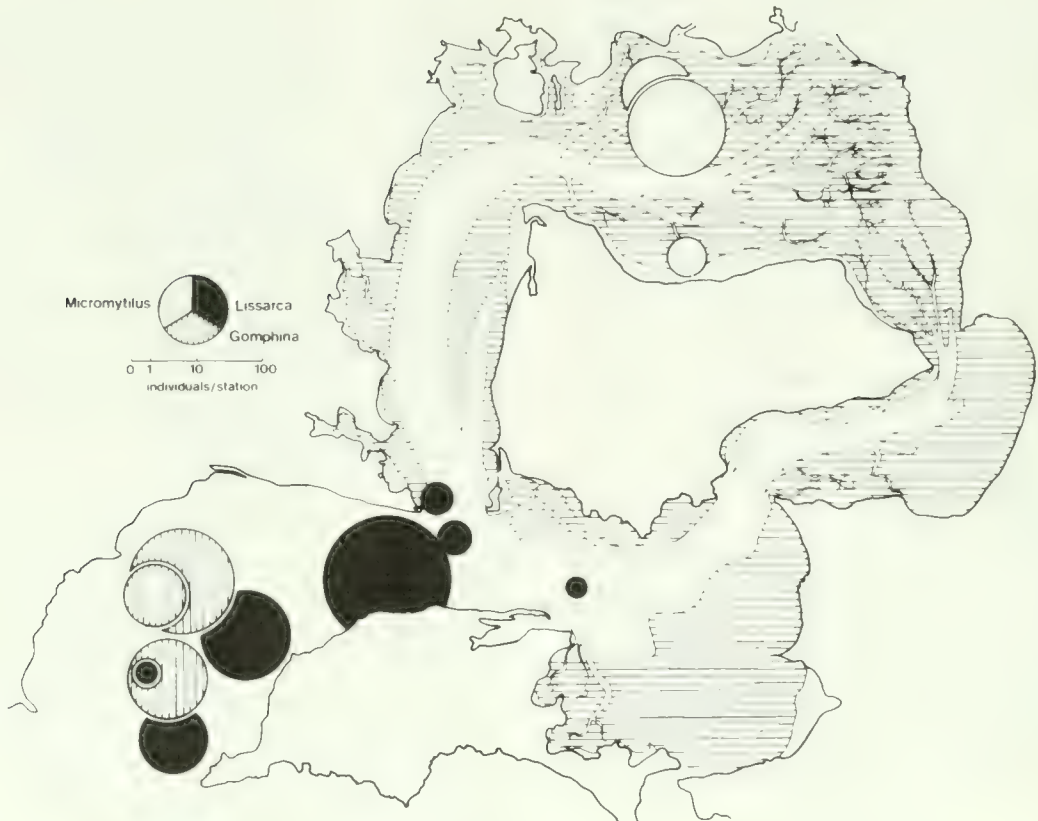

FIG. 4. Distribution of the dominant mollusc species *Micromytilus francisensis*, *Lissarca rubricata* and *Gomphina undulosa* at the Western Port sample stations. Circle size indicates the total number of individuals of these species and segment size indicates the proportion of each. (Species have been grouped together on the basis that they may be conveniently plotted on the same figure.)

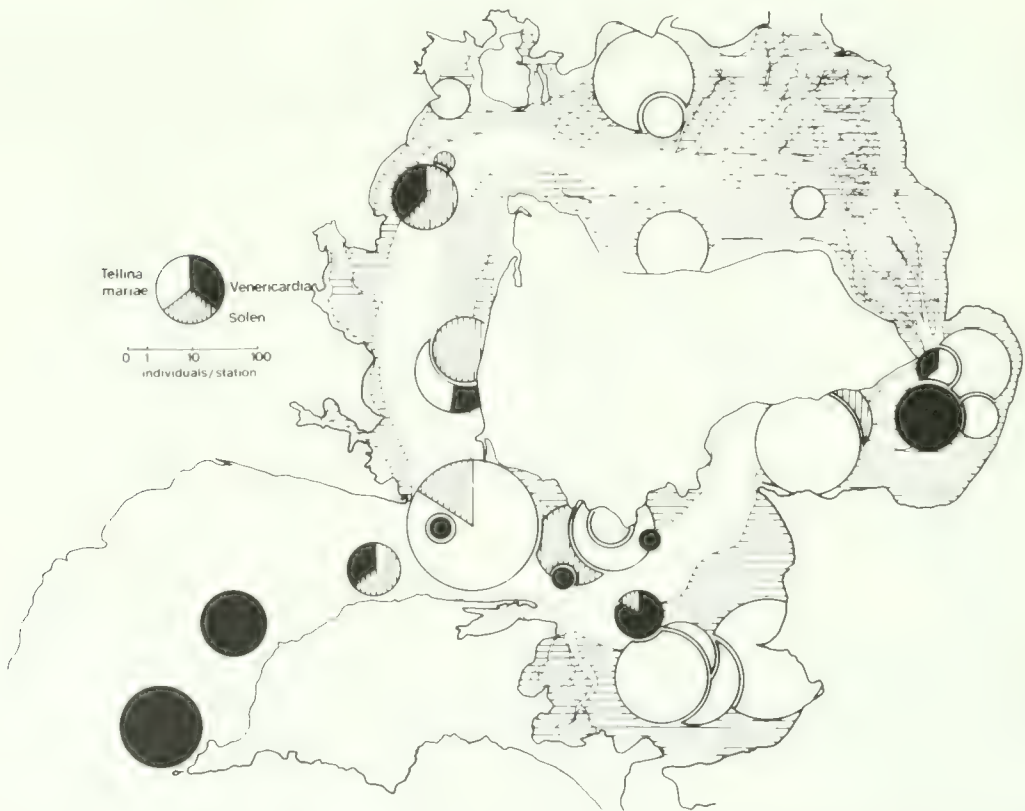

FIG. 5. Distribution of *Tellina mariae*, *Venericardia bimaculata* and *Solen vaginoides* in Western Port (see also caption to Fig. 4).

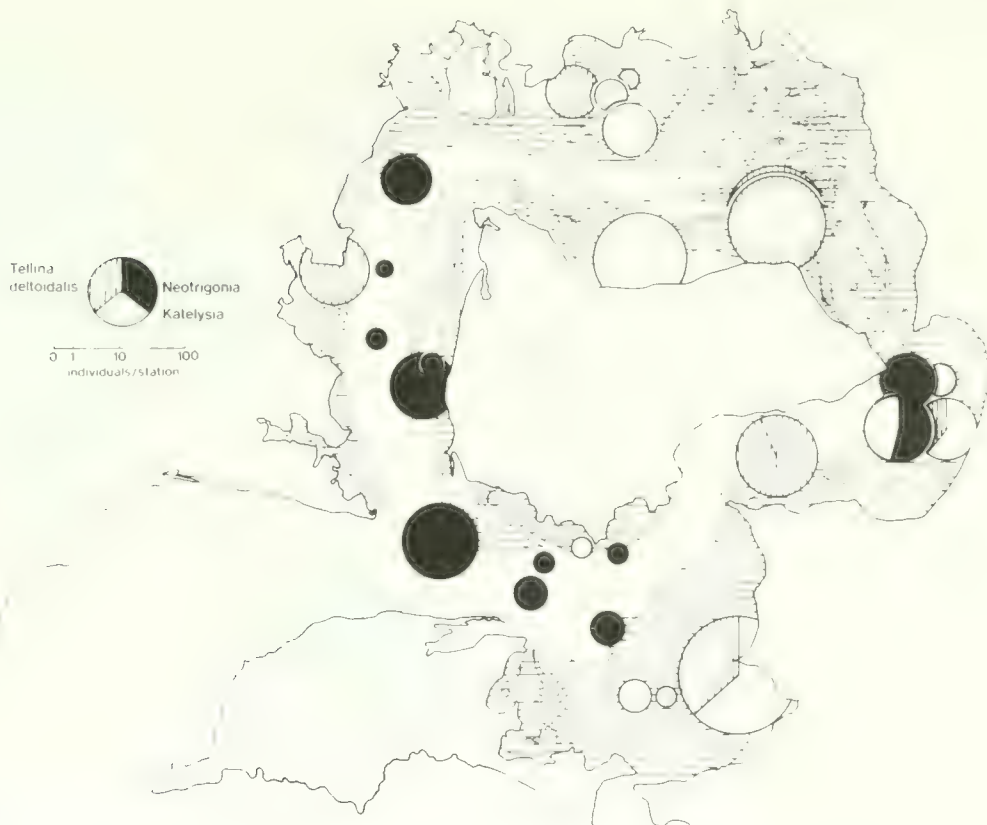

FIG. 6. Distribution of *Tellina deltoidalis*, *Neotrigonia margaritacea* and *Katelaysia rhytiphora* in Western Port (see also caption to Fig. 4).

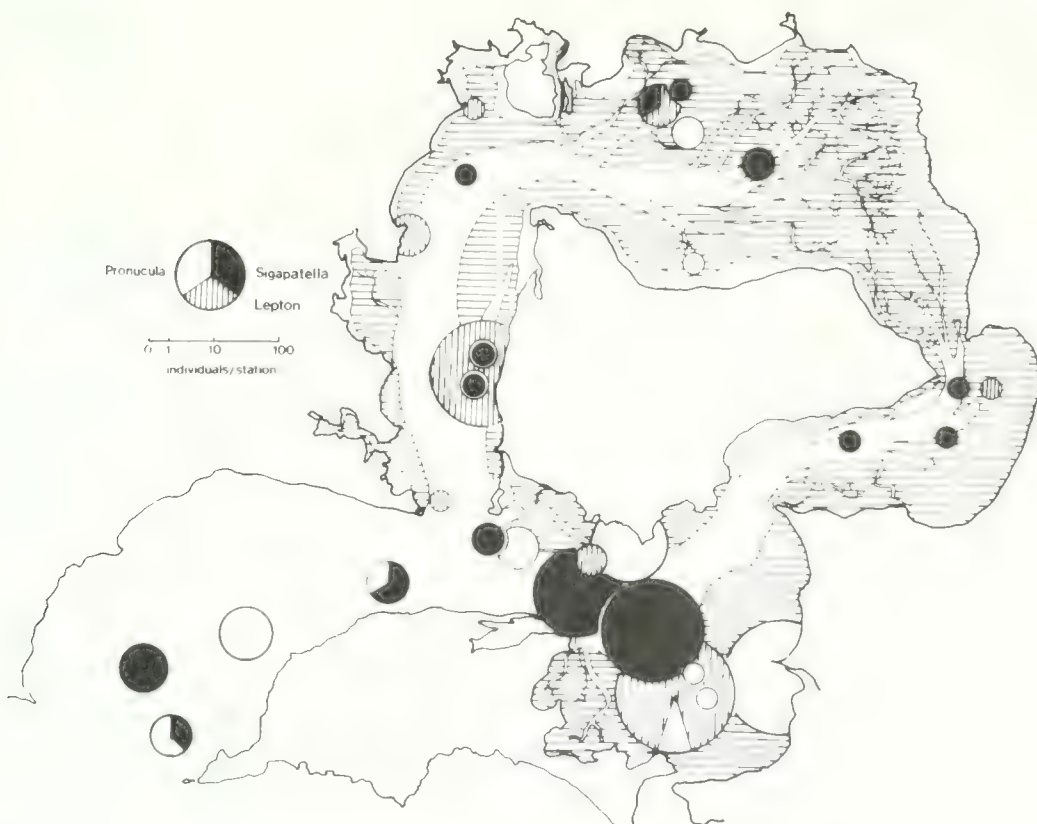

FIG. 7. Distribution of *Pronucula concentrica*, *Sigapatella calyptraeformis* and *Lepton frenchiensis* in Western Port (see also caption to Fig. 4).

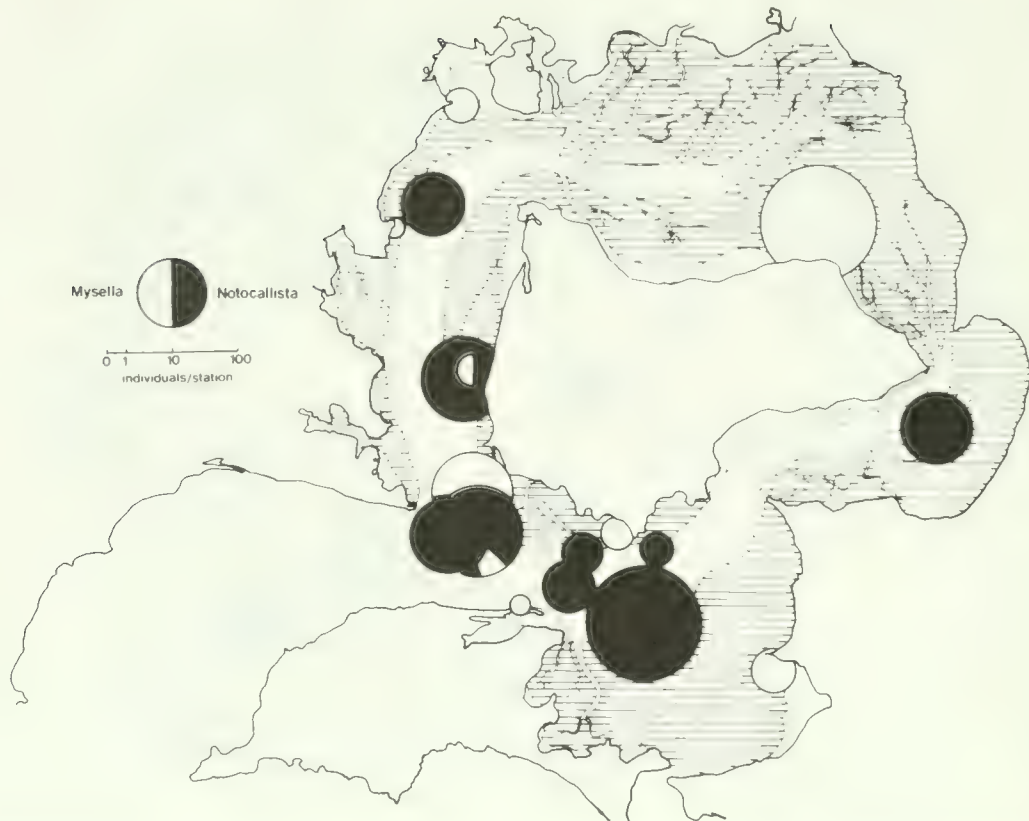

FIG. 8. Distribution of *Mysella donaciformis* and *Notocallista diemenensis* in Western Port (see also caption to Fig. 4).

strongest affinities with the fsma (Group 2, Fig. 9) and are considered as part of that assemblage.

Dendrograms calculated from binary (Fig. 10) and from abundance (Fig. 11) data show essentially the same patterns of station affinity and the same associations between station groups and sediment type. The correspondence between dendrograms is particularly marked at lower levels of dissimilarity.

At a dissimilarity of 1.2 the binary data dendrogram shows seven groups (Fig. 10 A–G). Groups A–D contain the stations from strata 1, 2, 3, 7, 9 and 10 which are grouped in the trellis diagram as the cmsa (Fig. 9, Group 1). Groups E–G contain the stations from strata 5, 6, 8 and 10 grouped in the trellis diagram as the fsma (Fig. 9, Group 2).

At a dissimilarity of 1.0 the dendrogram from abundance data shows six groups (Fig. 11, A–D, F–G) similar to those seen at a dissimilarity of 1.2 in the binary data dendrogram. Groups B in the two dendrograms correspond exactly; groups F and G differ by only one and three stations respectively; and the correspondence between the remaining groups, although not as good as for B, F, and G is still close.

Stations 1743 and 1745 which form the smallest group, B, in both dendrograms each contain a single species (*Gomphina undulosa*) which is found at only one other station (1742).

At higher levels of dissimilarity a major difference between the dendrograms is in the separation, in the binary data dendrogram (Fig. 10) of Group A from the remaining groups. This separation is probably a result of group-size dependency (Williams, Clifford & Lance, 1971) and not an indication that group A stations constitute a separate assemblage.

Comparison of the trellis diagram with the dendrograms suggests some transference of stations between assemblages. In both dendrograms stations 1703, 1711, 1713, 1714, 1715, 1727 and 1729, appear most closely related to the cmsa, but from the trellis diagram they are considered as part of the fsma. Most of the individuals at these transposed stations belonged either to rare species (which are not characteristic of either assemblage) or were species characteristic of the fsma (viz. *Lepton frenchiensis*, *Mysella donaciformis*, *Katelysia rhytiphora*, *Tellina mariae*). The trellis diagram therefore seems to give the most appropriate placing of these

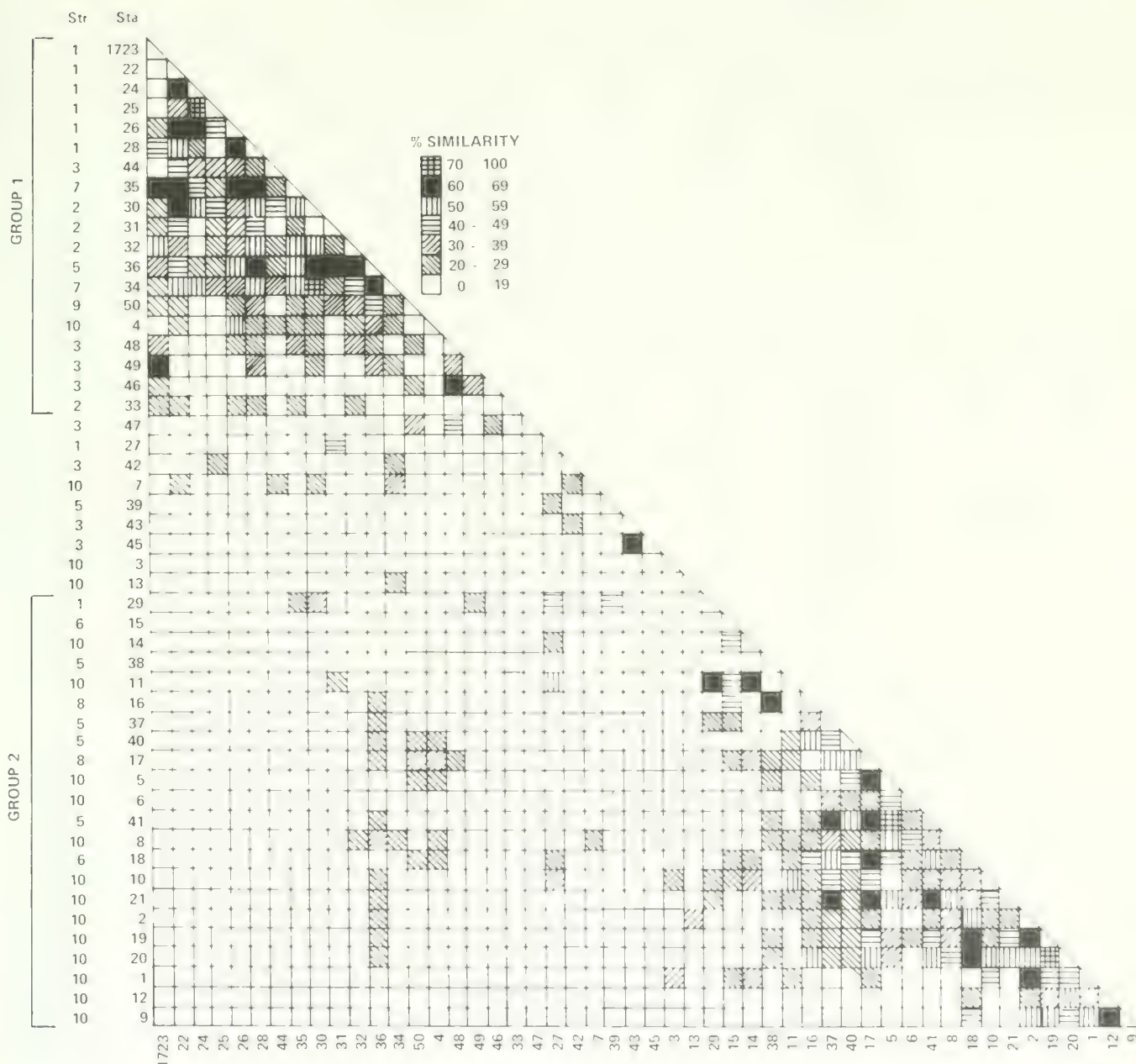

FIG. 9. Trellis diagram of faunal affinity between stations calculated from presence-absence data using the Czekanowski coefficient. Str = stratum number; Sta = station number.

stations and for comparative analysis stations were grouped into assemblages as indicated by the trellis diagram.

Comparison of faunal assemblages

Tests for significant differences between assemblages (Table 2) are only approximate. They indicate that the sediment of the stations in the cmsa is significantly coarser and less muddy than at the fsma stations. Sorting appears poorer in the fsma but the difference between assemblages is not significant at the 5% level.

The average number of species and average species diversity per station were significantly greater in the cmsa, but differences in

evenness were not significant. Differences in the number of species per station are also reflected in the total numbers of species per assemblage (Table 4). Only 15 of the 95 species were common to both assemblages. Of the remainder, 64 (67%) were exclusive to the cmsa. Total  $H'$  and  $J'$ , calculated for all individuals and species per assemblage, were 3.16 and 0.72 respectively for the cmsa and 2.26 and 0.66 for the fsma.

Most (79%) individuals in the cmsa were suspension-feeders. The average number of infaunal suspension-feeders per station did not differ significantly between assemblages, but average values for epifaunal and for total suspension-feeders per station did.

Most (51%) individuals in the fsma were

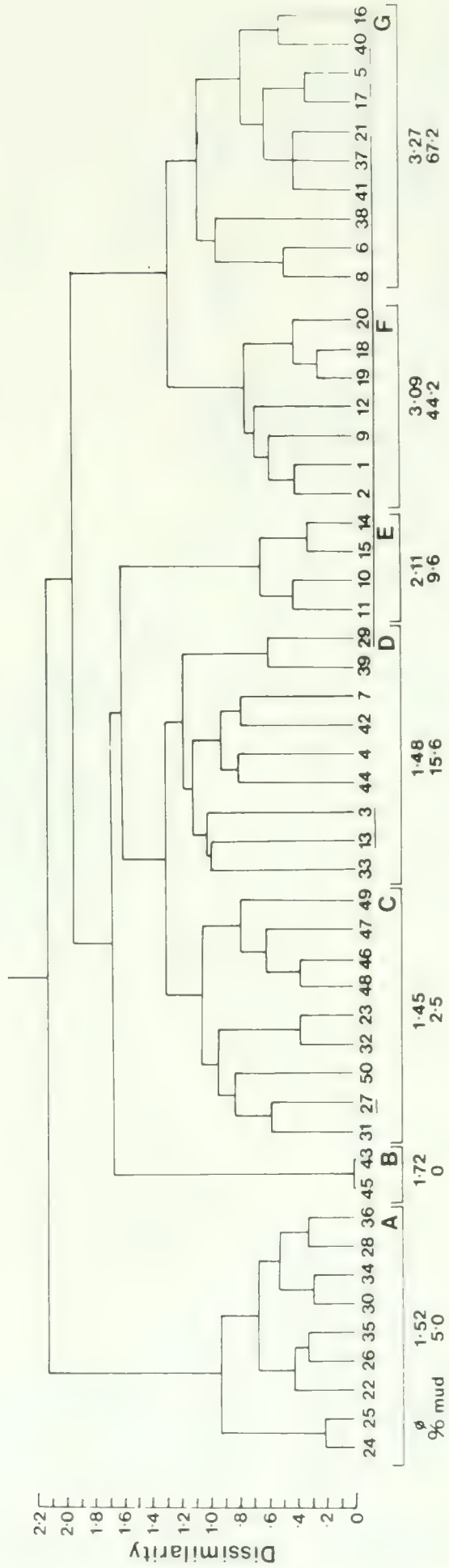

FIG. 10. Dendrogram of faunal affinity between stations calculated from presence-absence data using the Czekanowski Coefficient. Underlined numbers are those of the stations assigned from inspection of the trellis diagram to the fine sand and mud assemblage. Average values for mean grain size,  $\phi$ , and % mud for the station groups A-G are shown.



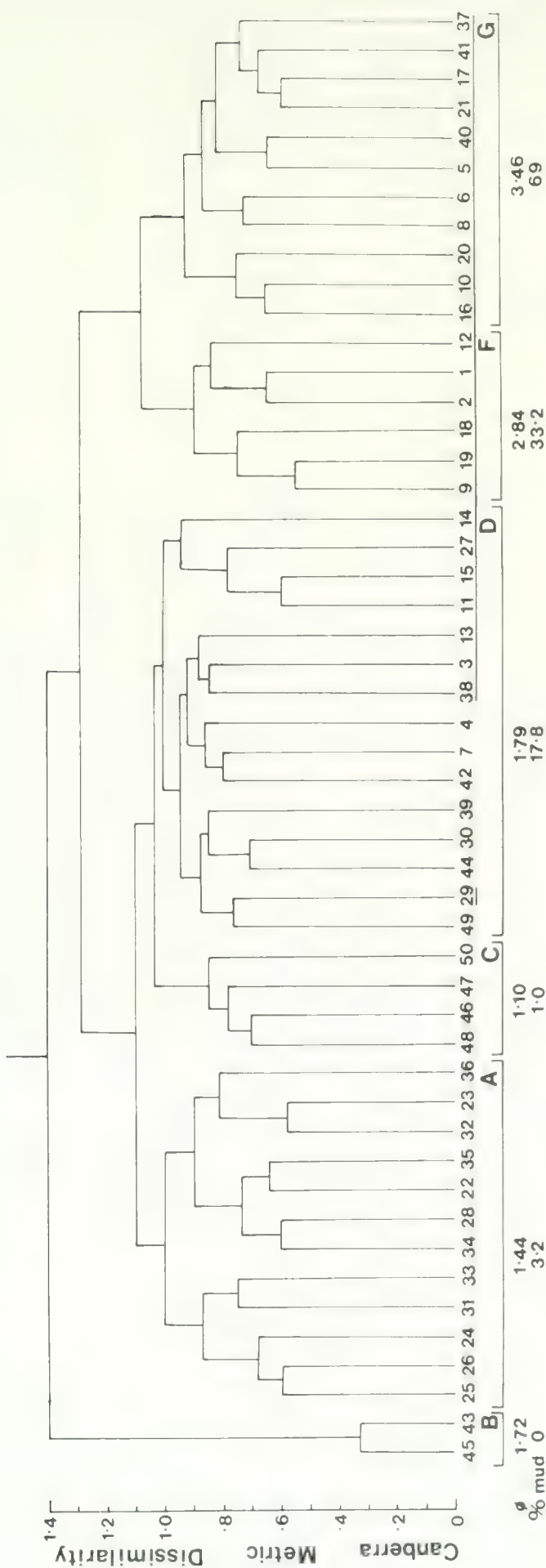

FIG. 11. Dendrogram of faunal affinity between stations calculated from abundance data using the Canberra Metric Dissimilarity Measure. Underlined numbers are those of the stations assigned from inspection of the trellis diagram to the fine sand and mud assemblage. Average values for mean grain size, φ, and % mud, for the station groups A-G are shown.

TABLE 4. Distribution of mollusc species between the molluscan assemblages recognised in the Western Port survey. The first figure indicates the total number or percentage of species in the assemblage. The figure in parentheses indicates the number or percentage exclusive to that assemblage.

	No. of species found in clean medium sand assemblage	% of species found in clean medium sand assemblage	No. of species found in fine sand and mud assemblage	% of species found in fine sand and mud assemblage
Polyplocophora	5 (5)	6.3 (6.3)	0 (0)	0 (0)
Gastropoda	30 (27)	38 (34.2)	13 (10)	41.9 (32.3)
Bivalvia—				
Infaunal suspension feeders	27 (22)	34.2 (27.9)	9 (4)	29.0 (12.9)
Epifaunal suspension feeders	13 (10)	16.5 (12.7)	5 (2)	16.1 (6.5)
Deposit feeders	3 (0)	3.8 (0)	3 (0)	9.7 (0)
Cephalopoda	1 (0)	1.3 (0)	1 (0)	3.2 (0)
Total	79 (64)	100 (81.1)	31 (16)	100 (51.7)

surface deposit-feeders, but they did not dominate the fsma to the extent that suspension-feeders dominated the cmsa. The difference between assemblages in the average values for surface deposit-feeders at a station approached but was not significant at the 5% level.

In both assemblages, most species were suspension-feeders, but the number exclusive to the cmsa was five times that exclusive to the fsma (Table 4). The number of species of surface deposit-feeders was the same in both assemblages although they are proportionately better represented in the fsma because of the smaller number of species in that assemblage.

With one exception the species dominant in any one assemblage are also those which are dominant bay-wide (Table 3). *Cyclopecten favus* was the only species dominant in an assemblage (fsma) but not constituting 2% or more of total individuals collected. Under the 2% criterion, *Lepton frenchiensis* and *Tellina mariae* are dominant in both assemblages, but are best considered as characteristic of the fsma. Both occurred at a greater proportion of the stations in the fsma; *Tellina* was also much more abundant in this assemblage although *Lepton* was almost equally abundant in both the cmsa and the fsma.

#### Stratum analysis

Analysis of variance (Table 5) indicated significant differences between strata in mean grain size and mud content, but these differences were not located. The only statistically significant faunal differences found were in the numbers of predators and scavengers.

Because these feeding types occurred at very few stations, the importance of these differences is uncertain and no attempt was made to locate them.

Other statistically significant differences were not found, but the average numbers of species, species diversity and suspension-feeding individuals at a station are higher in those strata (1, 2, 3, 7, 9) which together form the cmsa. The strata which form the cmsa are also those with the lowest average mud content and, in general, the coarsest mean grain size (Table 5).

Stratum analysis shows that the occurrence of surface deposit-feeders in the cmsa is largely due to their high incidence in stratum 9. This stratum contained only one station, 1750, which was in a shallow sublittoral area and has a wide range of affinities with stations in both assemblages. In the other strata which form the cmsa, the stations of which are in deeper water and have affinities chiefly amongst themselves, surface-deposit feeders are nearly or entirely absent. Stratum analysis also suggests the number of epifaunal suspension-feeders to be greatest in the East Arm and the Western Entrance (strata 2, 3 and 5).

#### Mollusc-sediment associations

The mollusc-sediment associations investigated are shown in Table 6. Because mean grain size was measured in  $\phi$  units, which increase as grain size decreases, a negative correlation between mean  $\phi$  and faunal attributes indicate that the attribute increases as grain size increases.

The number of species decreased signifi-

TABLE 5. Analysis by stratum of sediment and mollusc fauna characteristics in the Western Port survey. Numbers in parentheses indicate the number of stations per stratum. Asterisks denote significant difference ( $p < 0.05$ ) between strata. Mean grain size and sorting were calculated for one station only in stratum 8.

Mean $\pm$ SD/ Station for	Stratum									
	1(8)	2(4)	3(8)	5(6)	6(2)	7(2)	8(2)	9(1)	10(17)	
*Mean grain size $\phi$	1.41 $\pm$ 0.66	1.44 $\pm$ 0.45	1.36 $\pm$ 0.72	3.11 $\pm$ 1.94	1.82 $\pm$ 1.01	1.39 $\pm$ 0.19	1.67	2.48	2.48 $\pm$ 0.82	
*% mud in sub-stratum	0.83 $\pm$ 1.49	1.63 $\pm$ 3.01	2.07 $\pm$ 4.70	50.76 $\pm$ 40.51	18.4 $\pm$ 26.02	7.75 $\pm$ 9.84	59.1 $\pm$ 57.84	0.92	36.98 $\pm$ 36.22	
Sorting	0.87 $\pm$ 0.46	0.90 $\pm$ 0.20	0.81 $\pm$ 0.77	1.8 $\pm$ 0.67	1.17 $\pm$ 0.83	1.02 $\pm$ 0.04	0.79	0.38	1.13 $\pm$ 0.70	
No. of individuals	19.8 $\pm$ 20.1	22.3 $\pm$ 10.7	47.0 $\pm$ 38.7	39.7 $\pm$ 44.5	105.4 $\pm$ 145	27.5 $\pm$ 20.5	20.5 $\pm$ 23.3	177	29.5 $\pm$ 31.5	
No. of species	4.6 $\pm$ 1.8	6.5 $\pm$ 3	10.0 $\pm$ 7.5	3.3 $\pm$ 1.9	4.5 $\pm$ 3.5	7.5 $\pm$ 2.1	3.5 $\pm$ 2.1	18	4.7 $\pm$ 4.4	
Species diversity, H'	1.16 $\pm$ 0.46	1.26 $\pm$ 0.76	1.17 $\pm$ 0.89	0.62 $\pm$ 0.40	1.10 $\pm$ 0.64	1.6 $\pm$ 0.31	0.81 $\pm$ 0.35	1.95	0.85 $\pm$ 0.68	
Evenness, J'	0.81 $\pm$ 0.23	0.63 $\pm$ 0.28	0.65 $\pm$ 0.25	0.63 $\pm$ 0.19	0.86 $\pm$ 0.09	0.59 $\pm$ 0.06	0.73 $\pm$ 0.11	0.67	0.69 $\pm$ 0.14	
No. of epifaunal suspension feeders	1.0 $\pm$ 1.3	6.5 $\pm$ 10.5	19.9 $\pm$ 34.5	6.8 $\pm$ 13.4	0	1.5 $\pm$ 0.7	0	4	4.2 $\pm$ 11.3	
No. of infaunal suspension feeders	16.9 $\pm$ 20.2	13.8 $\pm$ 9.5	20.4 $\pm$ 17.2	20.3 $\pm$ 30.4	28.0 $\pm$ 35.4	22.5 $\pm$ 19.1	1.3 $\pm$ 0.57	69	8.4 $\pm$ 15.4	
Total number of suspension feeders	17.9 $\pm$ 19.9	20.3 $\pm$ 9.5	40.1 $\pm$ 35.9	27.2 $\pm$ 41.4	28.0 $\pm$ 35.4	24.0 $\pm$ 18.4	2.0 $\pm$ 1.4	73	12.6 $\pm$ 18.9	
No. of surface deposit feeders	0	0	2.6 $\pm$ 6.3	11.8 $\pm$ 14.4	76.5 $\pm$ 108.2	0	18.0 $\pm$ 21.2	91	12.6 $\pm$ 16.7	
*No. of predators	1.0 $\pm$ 1.8	1.0 $\pm$ 1.2	0.9 $\pm$ 1.4	0.3 $\pm$ 0.8	0	0	0.5 $\pm$ 0.7	1	1.1 $\pm$ 2.5	
No. of grazers	0.9 $\pm$ 1.4	0.8 $\pm$ 1.5	3.0 $\pm$ 3.9	0	1.0 $\pm$ 2.1	3.5 $\pm$ 2.1	0	8	3.2 $\pm$ 4.8	
*No. of scavengers	0	0.3 $\pm$ 0.5	0.4 $\pm$ 0.7	0.3 $\pm$ 0.8	0	0	0	4	0	

TABLE 6. Kendall rank correlations and partial rank correlations between sediment and mollusc fauna characteristics in the Western Port survey.  $\tau$  = correlation coefficient;  $p$  = probability of correlation being significant ( $p < 0.05$ ); ( $\tau$ ) = partial rank correlation with the effect of the other correlated sediment variable removed; NS = not significant.

	Mean $\phi$	% Mud	Sorting	Skewness
Mean $\phi$				
% Mud	$\tau = 0.41$ $p = <0.001$			
Sorting	$\tau = 0.33$ $p = 0.002$	$\tau = 0.33$ $p = 0.001$		
Skewness	$\tau = 0.27$	NS	$\tau = -0.31$	
No. of individuals	NS	NS	NS	NS
No. of species	$\tau = -0.19$ $p = 0.049$	NS	NS	NS
Species diversity, $H'$	NS	NS	$\tau = 0.23$ $p = 0.020$	NS
Evenness, $J'$	NS	NS	NS	NS
Total no. of suspension feeders	NS	NS	NS	NS
No. of infaunal suspension feeders	NS	NS	NS	NS
No. of epifaunal suspension feeders	$\tau = -0.24$ $p = 0.017$ ( $\tau = -0.19$ )	NS	$\tau = 0.20$ $p = 0.039$ ( $\tau = 0.31$ )	NS
No. of surface deposit feeders	$\tau = 0.33$ $p = 0.002$ ( $\tau = 0.19$ )	$\tau = 0.43$ $p = <0.001$ ( $\tau = 0.43$ )	NS	NS
Proportion of suspension feeders	$\tau = -0.32$ $p = 0.003$ ( $\tau = 0.24$ )	$\tau = -0.23$ $p = 0.023$ ( $\tau = -0.11$ )	NS	NS
Proportion of infaunal suspension feeders	NS	$\tau = -0.26$ $p = 0.010$	NS	NS
Proportion of epifaunal suspension feeders	$\tau = -0.43$ $p = 0.001$ ( $\tau = -0.39$ )	NS	$\tau = 0.23$ $p = 0.021$ ( $\tau = 0.44$ )	NS
Proportion of surface deposit feeders	$\tau = 0.38$ $p = <0.001$ ( $\tau = 0.23$ )	$\tau = 0.47$ $p = <0.001$ ( $\tau = 0.37$ )	NS	NS

cantly with increase in mean  $\phi$ . Species diversity was positively correlated with poorer sorting. Because finer sediments tend to be more poorly sorted, this relationship between species diversity and sorting suggests an increase in species diversity in fine sediments. However, no significant association was found between mean  $\phi$  and  $H'$ .

The number and proportion of epifaunal suspension-feeders increased with decrease in mean  $\phi$  and poorer sorting. The greater correlation coefficients and probabilities for the associations with mean  $\phi$  suggest the major association to be with this character-

istic. Partial correlation also indicates the major association to be with mean  $\phi$ .

The number of infaunal suspension-feeders was not significantly associated with the sediment characteristics investigated, although the association with mean  $\phi$  approached significance ( $p = 0.07$ ). The association between the proportion of infaunal suspension-feeders and mean  $\phi$  just failed to reach significance ( $p = 0.053$ ), but there was a significant negative correlation with mud.

The total number of suspension-feeders was not significantly associated with the sediment characteristics measured, but the pro-

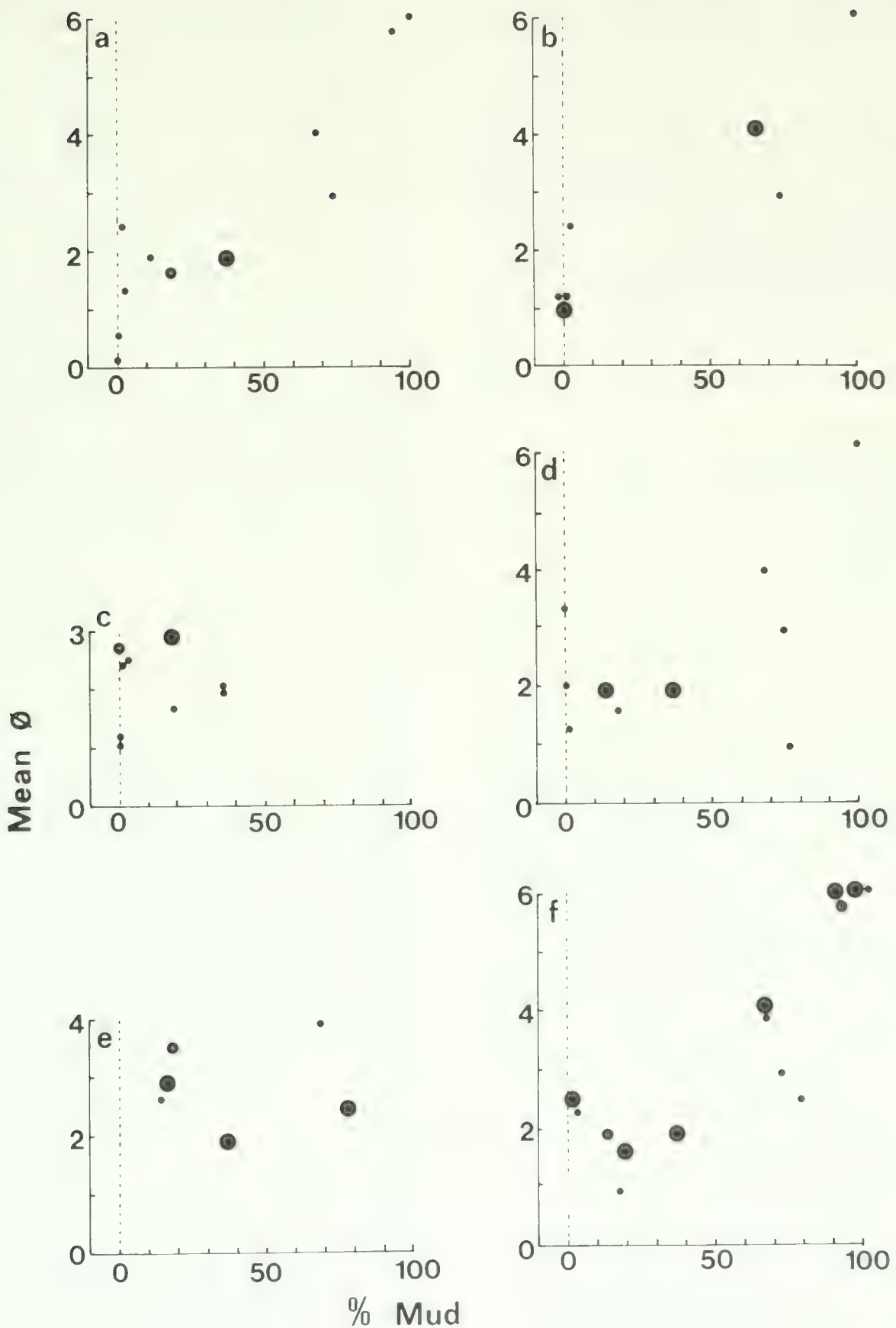

FIG. 12. Occurrence of the dominant infaunal species of the fsma in relation to sediment mean grain size (Mean  $\phi$ ) and mud content (% mud). Circle size indicates abundance; •, 1-9 individuals; ●, 10-19 individuals; ●, 20+ individuals.

a. *Pronucula concentrica*; b. *Lepton frenchiensis*; c. *Mysella donaciformis*; d. *Katelysia rhytiphora*; e. *Tellina deltoidalis*; f. *Tellina mariae*.

portion of suspension-feeders was significantly greater in coarser, less muddy sediment. Partial correlation indicated the greater association to be with mean  $\phi$ .

The most highly significant associations found were those of the number and proportion of surface deposit-feeders, both of which increased significantly with increase in mean  $\phi$  and increase in mud content. Partial correlation shows the most significant association to be with mud content.

The occurrence of the dominant infaunal species in relation to sediment mean grain size and mud content is illustrated in Figures 12 and 13.

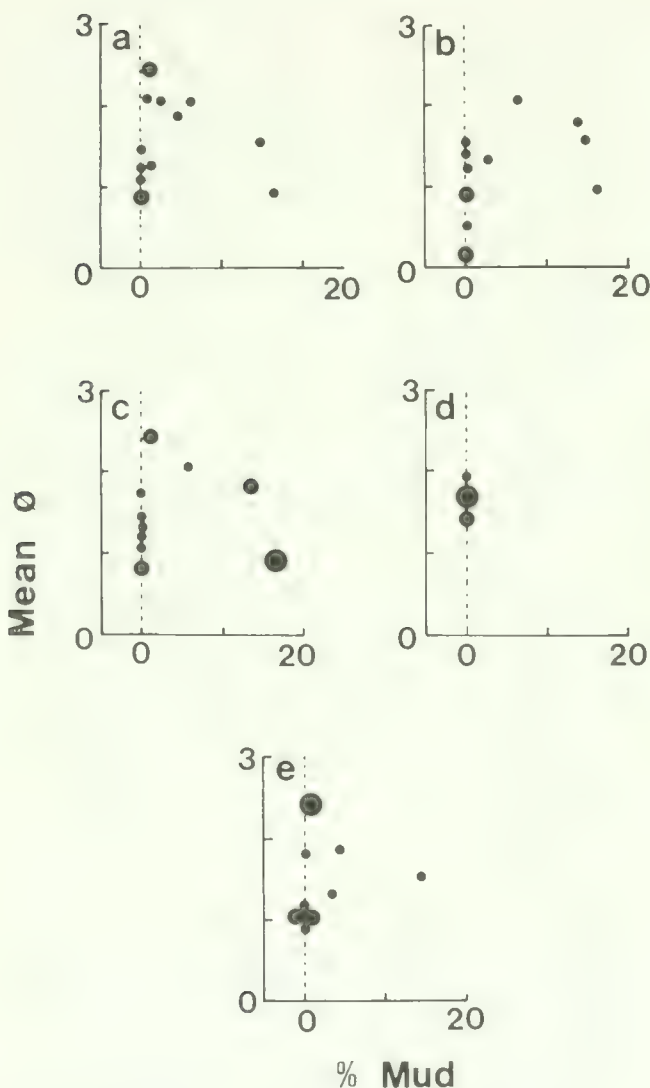

FIG. 13. Occurrence of the dominant infaunal species of the cmsa in relation to sediment mean grain size (Mean  $\phi$ ) and mud content (% mud). Circle size indicates abundance;  $\bullet$ , 1-9 individuals;  $\bullet$ , 10-19 individuals;  $\bullet$ , 20+ individuals.

a, *Neotrignonia margaritacea*; b, *Venericardia bimaculata*; c, *Notocallista diemenensis*; d, *Gomphina undulosa*; e, *Solen vaginoides*.

*Pronucula concentrica* (Fig. 12a) occurred at stations with mud contents ranging from 0-100% and in grain sizes ranging from coarse sand to silt. It occurred most abundantly in medium sand with a moderately high mud content. *Lepton frenchiensis* (Fig. 12b) occurred mainly in fine sand with up to 96% mud, but also at a few stations of medium, mud-free sand. *Mysella donaciformis* (Fig. 12c) occurred mainly in fine sand with less than 20% mud. *Katelsysia rhytiphora* (Fig. 12d) lives in sediments ranging from coarse to very fine sands and with mud contents from 0-100%, but was most abundant in fine sediments with 10-40% mud. *Tellina mariae* (Fig. 12f) occurred in sediments with mean grain sizes from coarse to very fine sand and mud contents ranging from 1-100% and was abundant over the whole range of sediments in which it was found. *Tellina deltoidalis* (Fig. 12e) was slightly more restricted in its occurrence than *Tellina mariae*, occurring most abundantly in fine sediments with a mud content of 10-80%.

*Neotrignonia margaritacea* (Fig. 13a) occurred in sediments ranging from coarse to fine sand but only at two stations where the mud content was in excess of 5%. Although mostly found in medium sand, it was found in greatest abundance at a station with a sediment of fine sand. *Venericardia bimaculata* (Fig. 13b) was taken mainly in sediments with less than 5% mud and with mean grain sizes ranging from coarse to fine sand. *Notocallista diemenensis* (Fig. 13c) was most abundant at a station with 16% mud but was most frequently taken from sediments with no mud and a grain size of medium sand. *Gomphina undulosa* (Fig. 13d) was found only at stations with medium sand and no mud. *Solen vaginoides* (Fig. 13e) occurred mainly at stations with little or no mud and in sands ranging from coarse to fine. Like *Neotrignonia*, it was most abundant at a station with little mud and a mean  $\phi$  of fine sand.

The dominant infaunal species characteristic of the fsma occurred over a much wider range of sediment types than did those characteristic of the cmsa. The lack of dominant fsma species in sediments with 40-70% mud (Fig. 12) does not indicate any discontinuity in distribution. Instead, it reflects the fact that only two stations had a mud content in this range.

*Mysella donaciformis* and *Tellina deltoidalis* were both most abundantly collected from

station 1701, *Katelysia rhytiphora* and *Pronucula concentrica* from station 1718, and *Solen vaginoides* and *Tellina mariae* from station 1750. In each of these pairs the species are of different feeding types, one being a suspension and the other a deposit feeder.

## DISCUSSION

### Survey design and analysis

The survey from which these mollusc data are drawn (Coleman et al., 1978) was carried out as part of a multidisciplinary environmental study of Western Port (Ministry of Conservation, 1975; Shapiro & Connell, 1975). The purpose of the environmental study was to provide data for use in the management of Western Port, and the benthic survey was required to provide information in accord with this purpose. Because species abundance, distribution and community structure throughout much of the bay had not previously been sampled, a bay-wide view of the fauna was required; and because future development in the bay may be regional, a regional knowledge of the fauna was also needed. These two, somewhat contradictory, requirements are satisfied by the chosen survey design of stratified random sample with proportional allocation of samples to strata.

It is important to distinguish clearly between the usefulness to benthic surveys of survey statistical procedures and of affinity analysis. Benthic surveys have at least three important aspects: the provision of unbiased universe estimates (of faunal abundance and diversity); the provision of unbiased regional estimates; and the allowance of statistically testable inter-regional (and possibly also temporal) comparisons. These requirements are met by stratified random sampling. But this design requires an a priori subdivision of the survey area. In the absence of a previous survey, this subdivision should be made on the basis of variables (in the present instance sediment type) which are expected to be correlated with species distribution (Weber, 1973).

Stratum analysis allows accurate regional and universe estimates of species abundance and diversity, and also allows statistically valid inter-regional comparisons. It also reveals regional variations in faunal characteristics (e.g. that the occurrence of deposit

feeders in the cmsa is due mainly to their occurrence in stratum 9) which may be of significance and yet are not so apparent when the more general view, of faunal assemblages, is taken.

The use of faunal affinity analysis and the grouping of stations into assemblages presents a more general view of the fauna; shows the manner in which different regions of the bay relate to each other in terms of faunal similarity; emphasizes fauna-sediment relationships; and suggests differences (e.g. fewer species and lower species diversity in fine sediments) which are not so apparent from stratum analysis. Affinity analysis can also suggest the definition of better strata for future survey work.

The similarity in faunal assemblages defined, in the present survey, from presence-absence and from quantitative data has important practical implications. It supports the view of Moore (1971) that the collection of presence-absence data, which may be accomplished more rapidly than the collection of quantitative data, may be the most useful initial approach, especially when surveying areas about which little is known.

Analysis using presence-absence data also has the advantage that when it is between samples taken at different times it may well be unaffected by seasonal or annual changes in individual abundance. This advantage is relevant to the present study. All the stations were sampled during the summer but stations 1742–1750 were sampled a year later than the others.

Affinity analysis using presence-absence data will be affected by changes in species composition, but there is evidence to show that changes in species composition are less marked than those in individual abundance. Buchanan et al. (1974, 1978) have shown that in benthic communities off the British coast species composition remains relatively stable but the relative abundances of species may change greatly with time. A similar situation is reported for Port Phillip, a bay adjacent to Western Port (Poore & Rainer, 1979).

In the present survey there is no evidence to suggest that temporal variation has significantly affected the results, even though the Western Entrance stations (1742–1750) were sampled a year after the rest. Faunal affinity analyses using both presence-absence and abundance data gave similar results, and in neither case did the Western Entrance stations show any clear tendency to separate

from the rest. Stratum analysis also failed to show differences which could be ascribed to temporal changes in species abundance and diversity.

#### Scope and success of the survey

Previous quantitative data from Western Port molluscs have been available only for a small area around Crib Point, in North Arm, which was sampled intensively in 1965 (Coleman, 1976). Most samples were taken from the deeper parts of the channel and showed *Neotrigonia margaritacea* and *Notocallista diemenensis* to be dominant. *Venericardia bimaculata* and *Solen vaginoides* were also found at these stations but not in sufficient quantity to be considered dominant. The few shallow water stations sampled were characterised by *Pronucula concentrica*, *Mysella donaciformis*, *Katelsia rhytiphora* and *Tellina mariae*.

The 1973–1975 survey has shown that the patterns of distribution shown around Crib Point are typical of the bay as a whole, but the extent to which this later survey presents a complete picture of the mollusc fauna will be limited by the extent and method of sampling.

The total area sampled in the 1973–1975 survey (15 m<sup>2</sup>) represents less than one forty-millionth of the area available to benthic molluscs (680 km<sup>2</sup> on the basis of water surface area but more if the surface area of weed fronds, stones, etc. is considered). Because the Smith-McIntyre grab is primarily an in-fauna sampler, mainly infaunal species were collected. Some epifaunal species, attached to stones and shell fragments, were collected, but no attempt was made to sample the fauna of hard substrata. Salt marshes and mangroves were also omitted from the survey.

To estimate the effects of these limitations the number of species collected was compared with the number of mollusc species in the archives of the National Museum of Victoria. These archives contain molluscs collected non-quantitatively from Western Port over many years and include species from salt marsh, rock and mangrove areas (Smith & Jepson, 1974). The comparison showed that 9.8% of the chiton, 7.2% of the gastropod, 38.5% of the bivalve and 12.5% of the cephalopod species previously recorded from the bay were collected in the present survey. The success of the survey, in terms of the proportion of known species found, is much higher if the comparison is only with archival material

from areas similar to those sampled in the present work. On this basis approximately 20% of known chiton, 25% of known gastropod and 100% of known bivalve species were found. The survey may therefore be assumed to provide a fairly accurate picture of the mollusc fauna, especially the bivalves, in those areas sampled.

#### The mollusc fauna of Western Port

In Western Port, as elsewhere (Sanders, 1958; Driscoll & Brandon, 1973; Georges, 1973; Lande, 1975), relatively few species are dominant and provide the majority of individuals. Nevertheless, the degree of dominance shown by species in Western Port is lower than that recorded from many other areas.

Only four species provided more than 10% of the individuals in the assemblages in which they were dominant. The most abundant of these was *Tellina mariae* which accounted for 29.1% of the molluscs in the fauna. In contrast, dominant species in the mollusc faunas described for the San Pedro Basin contributed up to 46% of individuals (Bandy, 1958); the most abundant species in collections made off the Dutch Coast accounted for 48.5% of individuals (Eisma, 1966); the most abundant molluscs in each of four mollusc assemblages described for Buzzards Bay accounted for 85.3%, 47.4%, 49.8% and 39% of the individuals in these assemblages (Driscoll & Brandon, 1973); the five most abundant molluscs in samples from the Borgenfjorden, Norway, together provided more than 80% of individuals (Lande, 1975); and in collections off the Delaware Coast, one species (*Mytilus edulis*) comprised 58% of the bivalves found (Maurer et al., 1979).

It is generally true that relatively few molluscan families provide genera used to characterize faunas (Jones, 1964), and most of the dominant species in Western Port belong to those genera or families which provide characteristic or dominant species in other parts of the world. Various species of *Tellina* and *Nucula* have been described as characteristic of fine sand and mud areas in Australia (Stephenson et al., 1974), Scotland (Gage, 1972), the Isle of Man (Jones, 1975) and the U.S.A. (Maurer, 1969; Frankenberg, 1971; Driscoll & Brandon, 1973; Kinner et al., 1974). Other *Tellina*, *Venus* and *Macoma* communities are listed in Thorson (1957). *Cyclocardium* (= *Venericardia*), *Mysella*, *Ensis*, and *Solen* species are reported as characteristic



of sandy substrata in the Middle Atlantic continental shelf region (Maurer et al., 1976), in the San Pedro Basin, California (Bandy, 1958) and off the coast of the Isle of Man (Jones, 1951). *Cyclopecten* valves are abundant in parts of the San Pedro Basin although this abundance is not reflected in samples of the living mollusc population (Wilson 1956). *Sigapatella novaezealandiae* is commonly found in Lyttelton Harbour, New Zealand, wherever there are shells and stones for attachment (Knight, 1974).

Although most of the dominant species in Western Port have parallels elsewhere, the occurrence of *Neotrigonia margaritacea*, a 'living fossil' (Gould, 1968), is an exception. The family Trigoniidae is represented by more than a hundred fossil species found throughout the world, but living species occur only around Australia (Bednall, 1878; Fleming, 1964). *N. margaritacea* has been recorded from a few localities in south-east Australia, but the present survey is the first to demonstrate quantitatively its presence as a faunal dominant.

The distribution of molluscs in Western Port is clearly related to sediment type and there are two major assemblages, one associated with mud-free, medium sand and the other with fine sand and mud. A few stations (e.g. 1708, 1736, 1750) showed a wide range of affinities within both assemblages, a fact apparent from the trellis diagram rather than the dendrograms. These stations were those situated near the boundaries of deep and shallow areas and contained species characteristic of coarse and those characteristic of fine sediments. There seems, therefore, to be a mixed, transitional fauna between the deeper and shallower areas, although the stations concerned were assigned, on the basis of their strongest affinities, to one or other of the assemblages as an analytical convenience.

Both epifaunal and infaunal diversity were higher in the coarser Western Port sediments. The same is true in other areas and has been attributed to increased habitat heterogeneity in coarse sediments (Nichols, 1970; Gray, 1974; Biernbaum, 1979). Boesch (1973) investigated sandy and muddy areas and found more species in the former. Approximately half the difference in numbers of species was due to the greater abundance of epifauna, mainly attached to shell and polychaete tube fragments, in the sandy areas. Similarly, in Western Port most epifaunal species were collected from stones, shell fragments and

bryozoa from the deeper parts of North and East Arms.

Surface deposit feeders showed a clear preference for the fine and muddy sediments of intertidal and shallow sublittoral areas in Western Port. Increased mud content is associated with increased organic content (Buchanan, 1958), and in Western Port areas of fine sediment are also those where sea-grasses and algae, living and as detritus, are most abundant.

Suspension feeders, as a group, showed less restriction in sediment preference. Although most suspension feeding species and individuals occurred in the cmsa, five of the eight dominant species in the fsma were suspension feeders. *Katelysia rhytiphora*, the most widespread of the suspension feeders in the fsma, has a distribution similar to that of *Tellina mariae*, the most abundant and widespread of the deposit feeders. At all but three of the stations occupied by *Tellina* but not by *Katelysia* one or both of the other dominant infaunal suspension feeders (*Mysella donaciformis*, *Lepton frenchiensis*) was found. In addition, the suspension feeding bivalve *Anadara trapezia*, a large and conspicuous species, though not numerically dominant in the survey was also found in areas inhabited by *Tellina*.

The survey therefore failed to provide evidence for trophic group amensalism (Rhoads & Young, 1970; Young & Rhoads, 1971). The co-occurrence of deposit and suspension feeders in the fsma may in part be due to the presence of seagrass and algae which stabilize the sediment. Measurement of the suspended matter in water draining from grassed and ungrassed flats shows that it is greater in water draining from ungrassed areas, probably because seagrass traps suspended matter and prevents or reduces resuspension (Brand & Bulthuis, 1976).

The co-occurrence of deposit- and suspension-feeders in the fsma may also be due, at least in part, to a wide tolerance of environmental conditions by the species concerned. Certainly, the species characteristic of the fsma occurred over a much wider range of sediments than did those characteristic of the cmsa. Similar distributions of the most common surface deposit and suspension feeders have also been found in Manukau Harbour, New Zealand, possibly because of a wide tolerance of environmental conditions by these species (Grange, personal communication). Levinton (1972) suggested that the un-

predictability and variable species composition of phytoplankton necessitates that suspension feeders remain food generalists, and therefore trophic specialization resulting from competition for food is reduced. In contrast, the constancy and predictability of the food available to deposit feeders may result in trophic specialization because of competition for food.

It might be inferred from Levinton's hypothesis that there should be more deposit feeding than suspension feeding species, but in Western Port the reverse is true.

Rather than being related to food supply, the diversity of deposit and suspension feeders in Western Port may be governed by those factors discussed by Franz (1976) who also obtained results contrary to Levinton's hypothesis. The low diversity of the deposit and of the suspension feeders inhabiting fine sediments arises from two factors. The homogenous conditions in these sediments reduces the rate at which species evolve to occupy different niches. In addition, the fine sediments, because they are intertidal or shallow sublittoral, are those subjected to the greatest temperature fluctuations, and the thermal stress imposed by these fluctuations has further limited species diversity.

When dominant species co-occurred at the same station they were of different feeding types. Calow & Calow (1975) have shown that morphologically similar freshwater gastropods can co-exist because they are physiologically differentiated, preferentially selecting those food items which they are most capable of digesting. The same is true for hydrobiid snails (Hylleberg, 1976) and possibly for surface deposit feeding bivalves for which there is evidence that the efficiency of feeding and assimilation is related to sediment type (Bubnova, 1974).

In contrast, it is unlikely that suspension feeders exercise any significant selection over their food intake, both because of their method of feeding and because they are food generalists (Levinton, 1972). The co-occurrence of dominant suspension feeding species could therefore lead to large populations competing for the same food resource, an obvious disadvantage in times of food shortage. When the maximal co-occurrences are of species of different feeding types such competition does not occur. Moreover, surface deposit feeders may be capable of using the faeces and pseudofaeces (and associated microorganisms) of suspension feeders

(Levinton, 1972; Levinton & Lopez, 1977). Divergence in the sediment preferences of different species of deposit and suspension feeders, which might also indicate divergence in preferences for other environmental characteristics, may therefore be a means of more evenly distributing dominant species and most effectively partitioning available food resources.

## APPENDIX

One of our referees usefully pointed out that the Shannon-Wiener diversity index and the Canberra Metric dissimilarity measure have each been the subject of recent criticism and review and suggested newer, potentially more useful, measures. The "expected species diversity measure" (Smith & Grassle, 1977; Smith, Grassle & Kravitz, in press) and the "normalized expected species similarity index" or NESS (Grassle & Smith, 1976) were singled out. Our attempts to comply with this suggestion produced results which are interesting, even though they did not reveal new insights about the mollusc fauna of Western Port.

### Diversity indices

Peet (1974) reviewed the measurement of species diversity in terms of heterogeneity indices as well as in terms of the component measures, species richness and equitability (evenness). He defined two types of heterogeneity measures: type I, being those "most sensitive to changes in the rarest species" and type II, being those "most sensitive to changes in the importance of the most abundant species" (p. 296). The Shannon-Wiener index is apparently the only type I index well known in benthic ecology and hence we used it in this study. We have also included the measure of evenness given in Pielou (1969).

Species richness is also presented in the paper. Richness was measured in terms of direct species counts, as the number of species per 0.3 m<sup>2</sup>. But richness is known to vary with sample size, i.e., the number of individuals in the sample (Peet, 1974). This is not a problem for the analyses done in this paper but would be if one wished to compare species richness of Western Port to other marine embayments where a different sample size was used. This problem was first addressed

by Sanders (1968) who aimed to calculate the number of species expected from each sample if all the samples were reduced to a standard size; Hurlbert (1971) presented a correct formula for calculating the expected number of species. Smith & Grassle (1977) noted that this "expected species diversity measure" allows one, by varying the standard sample size, to stress the abundant or rare species at will and proposed its use as a diversity measure.

The expected species diversity measure is explained in some detail by Smith & Grassle (1977). Suppose we have a finite "population" consisting of  $k$  species with  $n_i$  individuals of species  $i$ ; let  $n = \sum_i n_i$ . Then the expected number of species in a random sample without replacement of size  $m$  individuals is

$$\sum_{i=1}^k 1 - \frac{C(n - n_i, m)}{C(n, m)} \quad n > m$$

where  $C$  represents combination. For large  $m$ , the measure is sensitive to rare species; for small  $m$ , it depends mainly on the dominant species. For  $m=2$ , the measure is linearly related to Simpson's diversity index (a well-known, type II index; Peet, 1974). A further advantage of the measure is that it has a minimum variance unbiased estimator (Smith & Grassle, 1977; Smith, Grassle & Kravitz, in press).

The expected species diversity measure thus has some useful attributes, the major one to us being the flexibility in emphasizing abundant or rare species at will. Unfortunately, in practice the measure failed to provide useful insights into the diversity of the mollusc fauna of Western Port. Because of the extreme variation in number of individuals/station in Western Port, the "individual index"  $m$  cannot be set larger than 2 in calculating average diversity per station per assemblage (Table 2), or per stratum (Table 5). In this case ( $m = 2$ ) the expected species diversity is equivalent to Simpson's diversity index which emphasizes the abundant species only. We think that a type I measure is most useful in summarizing faunal diversity in Western Port. (There remains, of course, the possibility of calculating diversity per assemblage or per stratum—ignoring stations—but such calculations would be inadvisable considering that the variation between stations within assemblages [or strata] is considerable in Western Port.)

## Dissimilarity measures

The reviewer pointed out that in our affinity analyses we used the most robust agglomerative method and suggested that we use a method less sensitive to common species. The reviewer suggested that we consider the NESS measure. NESS is a normalized version of the expected number of species that two random samples of size  $m$  ( $< n$ ) drawn from the same population have in common (Grassle & Smith, 1976). For small  $m$ , the expected species shared is dependent on the abundant species; for large  $m$ , the less abundant species also contribute to the measure. By varying the sample size index,  $m$ , one can investigate the role of dominant and rare species.

In practice it was not possible to set  $m$  sufficiently large to make the NESS measure sensitive to uncommon species and yet still include all stations in the analysis; in Western Port there is a large amount of variation in numbers of individuals per station and a quite high proportion of stations with relatively few individuals. Moreover, with low values of  $m$  the NESS measure appears to be less sensitive to rare species than is the Canberra Metric.

For example, we calculated station affinity using the NESS measure with  $m = 2$ . Two of the fifty stations were, because of their dominant species, calculated as having a similarity of 1 even though their species are not identical. (Station 33 was represented by 1 individual of *Nanomactra jacksonensis* and 17 individuals of *Solen vaginoides*; station 26 was represented by 1 individual of *Sigapatella calyptraeformis*, 1 individual of *Neotrigonia margaritacea* and 9 individuals of *Solen vaginoides*.)

Further, the dendrogram generated from the NESS measure was compared to that generated from the Canberra Metric measure for the same subset of stations. The dendrogram generated from the NESS measure does not reveal any new patterns of faunal affinity (cf. Fig. 14 with Fig. 15) but, like the dendrogram generated from the Canberra Metric measure, indicated the presence of two major faunal station assemblages.

In the example given by Grassle & Smith (1976) the NESS measure was able to pick up a successional sequence following an oil spill (their Fig. 3). We felt that it would be interesting to see if the NESS measure would differentiate the Western Entrance stations (taken

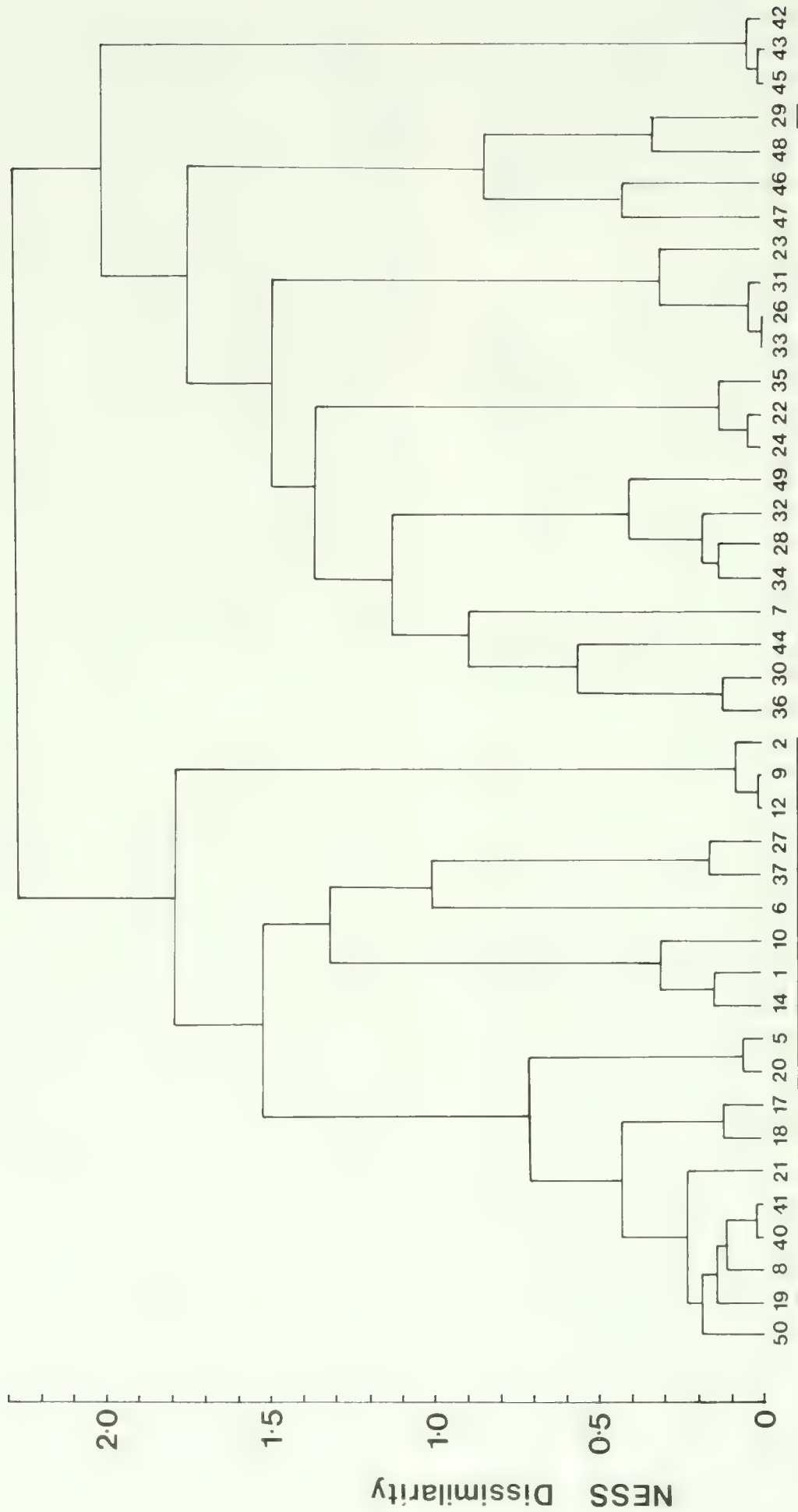

FIG. 14. Dendrogram of faunal affinity between stations calculated using the NESS measure with  $m = 2$ . Underlined stations are those assigned to the fine sand and mud assemblage (see text of paper for explanation). Stations 1703, 04, 11, 13, 15, 16, 28, 38, and 39 have been omitted from the analysis.

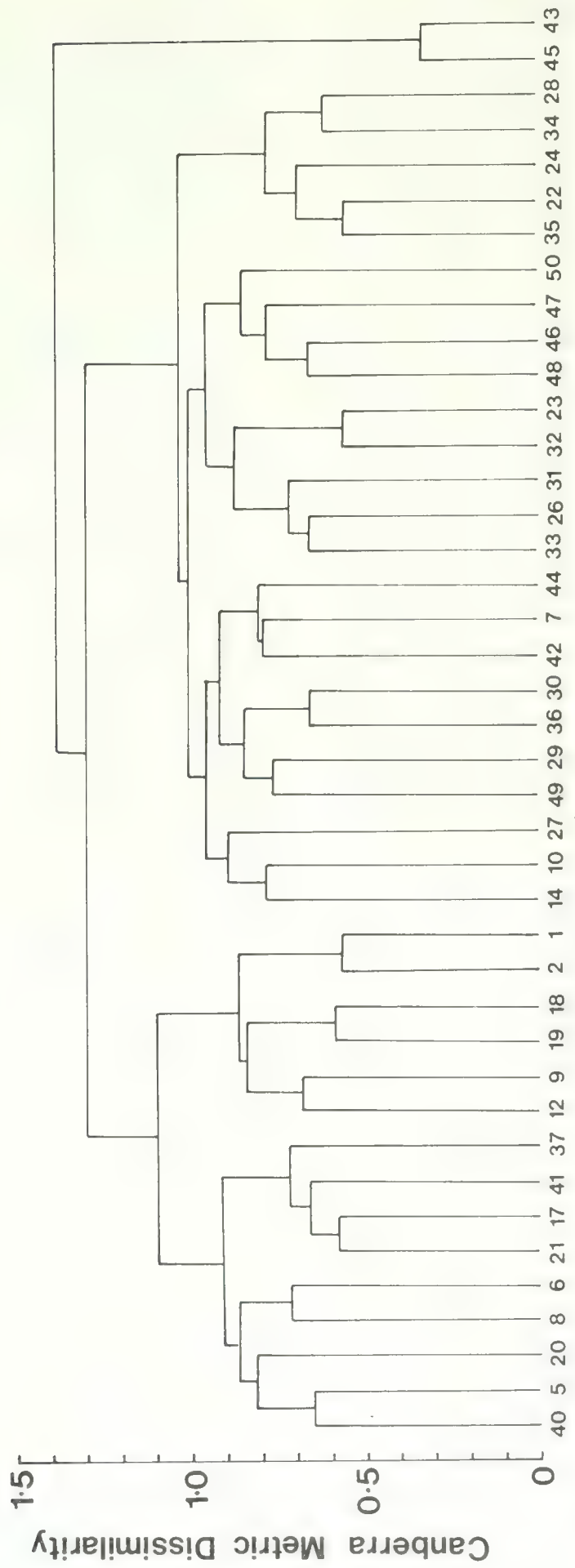

FIG. 15. Dendrogram of faunal affinity between stations calculated using the Canberra Metric Dissimilarity Measure. See also caption to Fig. 14.

in November 1975) from the other stations (subtidal stations taken in November 1973 and intertidal stations taken in January 1974). It did not.

Thus for Western Port mollusc data, at low values of *m*, the NESS measure seems to be less sensitive than the Canberra Metric measure; at high values it cannot accommodate all stations; and it does not reveal any radically different station patterns from those shown by the Czekanowski or the Canberra Metric measures.

#### ACKNOWLEDGEMENTS

Our thanks are due to the technical staff of the Marine Studies Group for help in the collection and sorting of samples; to the staff of the National Museum of Victoria for access to the mollusc collection there; to Mr. R. Burn, Honorary Associate of the National Museum of Victoria, for identifications of chitons and opisthobranchs; to Dr. W. F. Ponder, The Australian Museum, Sydney for identifications of a number of the small gastropod and bivalve species; to Mr. M. Mobley, Marine Studies Group, for help with statistical analysis; and to the Drafting Section, Ministry for Conservation, for help in the preparation of figures.

#### REFERENCES

- BANDY, O. L., 1958, Dominant molluscan faunas of the San Pedro Basin, California. *Journal of Paleontology*, 32: 703–714.
- BEDNALL, W. T., 1878, Australian Trigonias and their distribution. *Transactions and Proceedings and Report of the Philosophical Society of South Australia*, 77–84.
- BIERNBAUM, C. K., 1979, Influence of sedimentary factors on the distribution of benthic amphipods of Fishers Island Sound, Connecticut. *Journal of Experimental Marine Biology and Ecology*, 38: 201–223.
- BOESCH, D. F., 1973, Classification and community structure of macrobenthos in the Hampton Roads area, Virginia. *Marine Biology*, 21: 226–244.
- BRAND, G. & BULTHUIS, D., 1976, *The influence of seagrass on water quality*. Unpublished report to the Ministry for Conservation, Victoria, Australia.
- BUBNOVA, N. P., 1974, Consumption and assimilation of carbohydrates from marine sediments by deposit-feeding mollusks *Macoma balthica* (L.) and *Portlandia arctica* Gray. *Okeanologiya* 14: 912–916 (article in Russian not seen: abstract no. 18933 in Biological Abstracts, 1975, 60: 2027).
- BUCHANAN, J. B., 1958, The bottom fauna communities across the continental shelf of Accra, Ghana (Gold Coast). *Proceedings of the Zoological Society of London*, 130: 1–56.
- BUCHANAN, J. B., KINGSTON, P. F. & SHEADER, M., 1974, Long term population trends of the benthic macrofauna in the offshore mud of the Northumberland coast. *Journal of the Marine Biological Association of the United Kingdom*, 54: 785–795.
- BUCHANAN, J. B., SHEADER, M. & KINGSTON, P. F., 1978, Sources of variability in the benthic macrofauna off the south Northumberland coast, 1971–1976. *Journal of the Marine Biological Association of the United Kingdom*, 58: 191–209.
- BURN, R., 1966, Port Phillip Survey 1957–63. Opisthobranchia. *Memoirs of the National Museum of Victoria*, 27: 265–288.
- CALOW, P. & CALOW, L. J., 1975, Cellulase activity and niche separation in freshwater gastropods. *Nature*, 255: 478–480.
- CLIFFORD, H. T. & STEPHNSON, W., 1975, *An Introduction to numerical classification*. Academic Press, New York, 229 p.
- CLIFFORD, H. T. & WILLIAMS, W. T., 1976, Similarity Measures. Chap. 6, p. 37–46 in: *Pattern analysis in agricultural science* (Ed. W. T. WILLIAMS), 331 p. C.S.I.R.O./Elsevier Scientific Publishing Co., Amsterdam, Oxford, London.
- COLEMAN, N., 1976, A survey of the molluscs of Crib Point, Western Port, Victoria. *Journal of the Malacological Society of Australia*, 3: 239–255.
- COLEMAN, N., CUFF, W., DRUMMOND, M. & KUDENOV, J. D., 1978, A quantitative survey of the macrobenthos of Western Port, Victoria. *Australian Journal of Marine and Freshwater Research*, 29: 445–466.
- CUFF, W. & COLEMAN, N., 1979, Optimal survey design: lessons from a stratified random sample of macrobenthos. *Journal of the Fisheries Research Board of Canada*, 36: 351–361.
- CZEKANOWSKI, J., 1913, *Zarys metod statystycznyk*. Wendego, Warsaw.
- DRISCOLL, E. G. & BRANDON, D. E., 1973, Mollusc-sediment relations in northwestern Buzzards Bay, Massachusetts, U.S.A. *Malacologia*, 12: 13–46.
- EISMA, D., 1966, The distribution of benthic marine molluscs off the main Dutch coast. *Netherlands Journal of Sea Research*, 3: 107–163.
- FLEMING, C. A., 1964, History of the bivalve family Trigoniidae in the south west Pacific. *Australian Journal of Science*, 26: 196–204.
- FOLK, R. L., 1968, *Petrology of sedimentary rocks*. Hemphill's, Austin, Texas, 170 p.
- FRANKENBERG, D., 1971, The dynamics of benthic communities off Georgia, U.S.A. *Thalassia Jugoslavica*, 7: 49–55.
- FRANZ, D., 1976, Benthic molluscan assemblages in relation to sediment gradients in northeastern Long Island Sound, Connecticut. *Malacologia*, 15: 377–399.

- GAGE, J., 1972, A preliminary survey of the benthic macrofauna and sediments in Lochs Etive and Creran, sea-lochs along the west coast of Scotland. *Journal of the Marine Biological Association of the United Kingdom*, 52: 237–276.
- GEORGES, R., 1973, Abondances et dominances des mollusques dans un écosystème corallien (Moorea, Polynésie française). (not seen: abstract no. 42337 in Biological Abstracts, 1974: 58, p. 4545).
- GOULD, S. J., 1968, *Trigonia* and the Origin of Species. *Journal of the History of Biology*, 1: 41–56.
- GRASSLE, J. F. & SMITH, W. 1976, A similarity measure sensitive to the contribution of rare species and its use in investigation of variation in marine benthic communities. *Oecologia*, 25: 13–22.
- GRAY, J. S., 1974, Animal-sediment relationships. In: *Oceanography and Marine Biology an Annual Review* (Ed. H. BARNES) vol. 12: 223–261. Allen & Unwin, London.
- HURLBERT, S. H., 1971, The nonconcept of species diversity: a critique and alternative parameters. *Ecology*, 52: 577–586.
- HYLLEBERG, J., 1976, Resource partitioning on basis of hydrolytic enzymes in deposit-feeding mud snails (Hydrobiidae). 11. Studies on niche overlap. *Oecologia*, 23: 115–125.
- JONES, G. F., 1964, The distribution and abundance of subtidal benthic Mollusca on the mainland shelf of southern California. *Malacologia*, 2: 43–68.
- JONES, N. S., 1951, The bottom fauna off the south of the Isle of Man. *Journal of Animal Ecology*, 20: 132–144.
- KING, R. J., BLACK, J. H. & DUCKER, S. C., 1971, Port Phillip Bay Survey 2. Intertidal ecology of Port Phillip Bay with systematic list of plants and animals. *Memoirs of the National Museum of Victoria*, 32: 93–128.
- KINNER, P., MAURER, D. & LEATHEM, W., 1974, Benthic Invertebrates in Delaware Bay: Animal-sediment associations of the dominant species. *Internationale Revue der Gesamten Hydrobiologie*, 59: 685–701.
- KNIGHT, G. S., 1974, Benthic community structure in Lyttelton Harbour. *New Zealand Journal of Marine and Freshwater Research*, 8: 291–306.
- LANCE, G. N. & WILLIAMS, W. T., 1967, A general theory of classificatory sorting strategies. I. Hierarchical Systems. *Computer Journal*, 9: 373–380.
- LANDE, E., 1975, The distribution of pelecypods in Borgenfjorden, North-Trøndelag, Norway. *Norwegian Journal of Zoology*, 23: 55–66.
- LEVINTON, J., 1972, Stability and trophic structure in deposit-feeding and suspension-feeding communities. *American Naturalist*, 106: 472–486.
- LEVINTON, J. S. & LOPEZ, G. R., 1977, A model of renewable resources and limitation of deposit-feeding benthic populations. *Oecologia*, 31: 177–190.
- MACPHERSON, H. H., 1966, Port Phillip Survey 1957–63. Mollusca. *Memoirs of the National Museum of Victoria*, 27: 201–264.
- MACPHERSON, H. H. & GABRIEL, C. H., 1962, *Marine Molluscs of Victoria*. Melbourne University Press, 475 p.
- MARSDEN, M. A. H. & MALLETT, C. W., 1974, *Morphology and sediment distribution, Westernport Bay, Victoria*. Report to: Westernport Bay Environmental Study, Ministry for Conservation, Victoria.
- MARSDEN, M. A. H. & MALLETT, C. W., 1975, Quaternary evolution, morphology and sediment distribution, Westernport Bay, Victoria. *Proceedings of the Royal Society of Victoria*, 87: 108–139.
- MAURER, D., 1969, Pelecypod-sediment association in Tomales Bay, California, *Veliger*, 11: 243–249.
- MAURER, D., KINNER, P., LEATHEM, W. & WATLING, L., 1976, Benthic faunal assemblages off the Delmarva Peninsula. *Estuarine and Coastal Marine Science*, 4: 163–177.
- MAURER, D., LEATHEM, W., KINNER, P. & TINSMAN, J., 1979, Seasonal fluctuations in coastal benthic invertebrate assemblages. *Estuarine and Coastal Marine Science*, 8: 181–193.
- MINISTRY FOR CONSERVATION, VICTORIA, 1975, *A preliminary report on the Westernport Bay Environmental Study*. 581 p. + A1–A73.
- MOORE, P. G., 1971, Ecological Survey Strategy. *Marine Pollution Bulletin*, 2: 37–39.
- MORTON, J. E., 1958, *Molluscs*. Hutchinson, London, 232 p.
- NICHOLS, F. H., 1970, Benthic polychaete assemblages and their relationship to the sediment in Port Madison, Washington, *Marine Biology*, 6: 48–57.
- PEET, R. K., 1974, The measurement of species diversity. In: *Annual review of ecology and systematics* (Editors: R. F. JOHNSON, P. W. FRANK & C. D. MICHENER), Volume 5: 285–307. Annual Reviews, Palo Alto, California.
- PIELOU, E. C., 1969, *An introduction to mathematical ecology*. Wiley-Interscience, New York, 286 p.
- POORE, G. C. B. & RAINER, S., 1974, Distribution and abundance of soft-bottom molluscs in Port Phillip Bay, Victoria, Australia. *Australian Journal of Marine and Freshwater Research*, 25: 371–411.
- POORE, G. C. B. & RAINER, S. F., 1979, A three-year study of benthos of muddy environments in Port Phillip Bay, Victoria. *Estuarine and Coastal Marine Science*, 9: 477–497.
- RHOADS, D. C. & YOUNG, D. K., 1970, The influence of deposit-feeding organisms on sediment stability and community trophic structure. *Journal of Marine Research*, 28: 150–178.
- SANDERS, H. L., 1958, Benthic studies in Buzzards Bay. 1. Animal-sediment relationships. *Limnology and Oceanography*, 3: 245–258.

- SANDERS, H. L., 1968, Marine benthic diversity: a comparative study. *American Naturalist*, 102: 243–282.
- SHAPIRO, M. A. & CONNELL, D. W., 1975, The Westernport Bay Environmental Study. *Proceedings of the Royal Society of Victoria*, 87: 1–10.
- SIEGEL, S., 1956, *Nonparametric statistics for the behavioral sciences*. McGraw-Hill, New York, 312 p.
- SMITH, B. J. (Ed.) 1971, *Marine Study Group of Victoria, Littoral Survey of Western Port Bay, Interim Report*. National Museum of Victoria, Melbourne.
- SMITH, B. J., COLEMAN, N. & WATSON, J. E., 1975, The invertebrate fauna of Westernport Bay. *Proceedings of the Royal Society of Victoria*, 87: 149–155.
- SMITH, B. J. & JEPSON, D., 1974, *Museum study of archival material. Westernport Environmental Study Project*. Final Report to Ministry for Conservation, Victoria.
- SMITH, W. & GRASSLE, J. F., 1977, Sampling properties of a family of diversity measures. *Biometrics*, 33: 283–292.
- SMITH, W., GRASSLE, J. F. & KRAVITZ, D., in press, Measures of diversity with unbiased estimators. In: *Ecological diversity in theory and practice*, Statistical Ecology Volume S6. International Cooperative Publishing House, Fairland, Maryland.
- SOKAL, R. R. & ROHLF, F. J., 1969, *Biometry, the principles and practice of statistics in biological research*. Freeman, San Francisco, 776 p.
- SOUTHWOOD, T. R. E., 1966, *Ecological methods*, Methuen, London, 391 p.
- STEPHENSON, W., WILLIAMS, W. T. & COOK, S. D., 1974, The benthic fauna of soft bottoms, southern Moreton Bay. *Memoirs of the Queensland Museum*, 17: 73–123.
- THORSON, G., 1957, Bottom communities (sublittoral or shallow shelf). *Geological Society of America Memoir*, 67(1): 461–534.
- WADLEY, F. M., 1952, *Elementary sampling principles in entomology*. Publication ET302, 17 p., U.S. Department of Agriculture, Bureau of Entomology and Plant Quarantine. (Not seen; cited in Southwood, 1966).
- WATSON, J. E. (Ed.), 1971, *Preliminary account of the benthic flora and fauna of N-W Westernport*. Unpublished report of the Underwater Research Group of Victoria, c/o National Museum of Victoria, Melbourne.
- WEBER, C.I. (Ed.), 1973, *Biological field and laboratory methods for measuring the quality of surface waters and effluents*. EPA 670/4-73001. U.S. Environmental Protection Agency, Cincinnati, Ohio 45268.
- WILLIAMS, W. T., CLIFFORD, H. T. & LANCE G. N., 1971, Group size dependence: a rationale for choice between numerical classifications. *Computer Journal*, 14: 157–162.
- WILSON, D. M., 1956, *Quantitative survey of the benthic Mollusca of San Pedro Basin area, southern California*. M.Sc. thesis. University of Southern California (Not seen: cited in Bandy, 1958).
- YOUNG, D. K. & RHOADS, D. C., 1971, Animal-sediment relations in Cape Cod Bay, Massachusetts. I. A transect study. *Marine Biology*, 11: 242–254.



## GENETIC DIVERGENCE BETWEEN POPULATIONS OF *GONIOBASIS* (PLEUROCERIDAE) OCCUPYING DIFFERENT DRAINAGE SYSTEMS<sup>1</sup>

Steven M. Chambers

*Department of Zoology, University of Florida, Gainesville, FL 32611, U.S.A.*<sup>2</sup>

### ABSTRACT

Genetic divergence at 18 loci was determined by starch gel electrophoresis for 18 Florida populations of *Goniobasis*. These data give a different view of species relationships than previous work based on shell morphology.

Divergence in shell sculptural characters between populations of the *G. floridensis* complex was often found to be accompanied by relatively little or no genetic divergence.

A gene diversity analysis was performed on the electrophoretic data from the *G. floridensis* complex to evaluate the importance of isolation in different drainage systems on genetic divergence. Nearly half of the total gene diversity was between drainage systems. The remaining gene diversity was distributed within populations (34%) and between populations within drainages (20%). Divergence in the *G. floridensis* complex has been greatly facilitated by the low frequency of dispersal between drainage systems.

### INTRODUCTION

The geographic distributions of most fresh-water-inhabiting species are subdivided by the discontinuous distribution of their habitat. This subdivision of habitat by land barriers is comparable to the case of an archipelago, which consists of terrestrial habitat subdivided by water barriers (MacArthur & Wilson, 1967). Differentiation between closely related populations that inhabit different islands in an archipelago has been widely noted (Darwin, 1860; Mayr, 1963). Early in his career as a naturalist, Darwin (1860) recognized divergence between populations of finches, tortoises, and other organisms on different islands of the Galápagos Archipelago. Such complex patterns of divergence have more recently been cited by Mayr (1963) as evidence for the theory of geographic speciation. If archipelagos are comparable in this respect to freshwater systems, then one might expect to find evolutionary divergence between closely related populations of an aquatic organism that are separated by land barriers. If these populations occupy different drainage systems, land barriers between drainages should reduce gene flow and increase evolutionary divergence between the populations.

The most widely used method for quantify-

ing genetic divergence between populations is the study of electrophoretically-detected biochemical (isoenzyme) variation (Ayala, 1976). Systematists employing this method have detected between drainage genetic divergence in species of sunfish (Avisé & Smith, 1974), minnows (Merritt et al., 1978), and newts (Hedgecock, 1978).

Fresh-water prosobranch snails of the genus *Goniobasis* (Mesogastropoda: Pleuroceridae) are a diverse and conspicuous element of the fresh-water fauna of the southeastern United States. In Florida they are most abundant in springs and spring-fed rivers and streams (Clench & Turner, 1956). In an earlier electrophoretic study, Chambers (1978) was able to distinguish two sympatric sibling species of *Goniobasis* in the Ichetucknee River in northern Florida. The present paper describes genetic variation in additional populations of Florida *Goniobasis*, with special reference to genetic divergence within and between drainage systems occupied by the *G. floridensis* complex.

### MATERIALS AND METHODS

*Collection sites:* Collection sites were chosen on the basis of the morphological form or species present, the accessibility of the

<sup>1</sup>This paper is dedicated to the memory of Prof. Irwin M. Newell

<sup>2</sup>Present address: Office of Endangered Species, U.S. Fish and Wildlife Service, Department of the Interior, Washington, D.C. 20240, U.S.A.

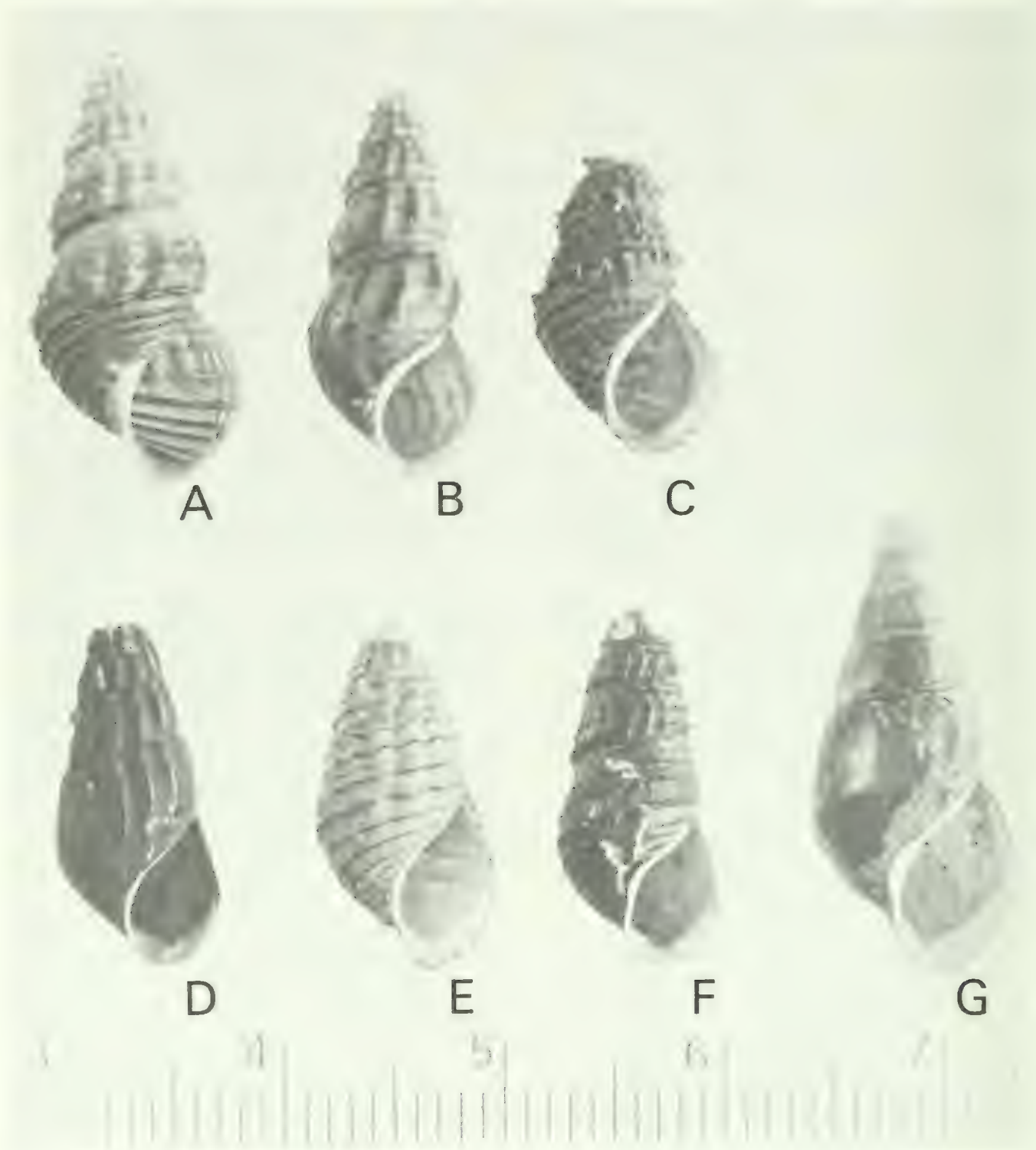

FIG. 1. Shells of adult *Goniobasis*. A. *G. floridensis*, site 4. B. *G. vanhyningiana*, site 1. C. *G. atearni*, site 10. D. *G. curvicostata*, site 10. E. *G. albanensis*, site 9. F. *G. floridensis*, site 15. G. *G. dickinsoni*, site 13. The scale is numbered in cm.

site, and the relative abundance of *Goniobasis*. Species identifications were based on the descriptions of shell characters in Clench & Turner (1956), except as noted below. Each site is identified below with its latitude and longitude, the name or names of the species sampled, and the locality code number that appears in Tables 1–2 and Figs. 2 and 3. All

collection sites are in Florida. Voucher specimens for each sample have been deposited in the United States National Museum (USNM) or the Florida State Museum (FSM).

1. Rock Spring, Kelly Park, Orange Co. 28°15'N; 81°30'W. *Goniobasis vanhyningiana* Goodrich, 1921. See Fig. 1B. USNM 782355.

2. Juniper Spring, Ocala National Forest, Marion Co. 29°11'N; 81°41'W. *G. vanhyningiana*. USNM 782354.

3. Juniper Creek at State Highway 19, Ocala National Forest, Marion Co. 29°13'N; 81°39'W. USNM 782356. These snails fit Clench & Turner's (1956) description of *G. floridensis* (Reeve, 1860). They are here considered to be *G. vanhyningiana* based on evidence presented later in this paper.

4. Rainbow River, Marion Co., at K. P. Hole County Recreation Center. 29°05'N; 82°26'W. *G. floridensis*. See Fig. 1A. USNM 782346.

5. Wekiva River at State Highway 343, Levy Co. 29°17'N; 82°41'W. *G. floridensis*. USNM 782349.

6. Waccasassa River at U.S. Highway 19, Levy Co. 29°17'N; 82°44'W. *G. floridensis*. USNM 782350. The shells of most *Goniobasis* at this site lack the spiral cords and nodules characteristic of *G. floridensis* as described by Clench & Turner (1956). They are here considered to be conspecific with *G. floridensis* based on evidence presented later in this paper.

7. Ichetucknee River at the Florida Department of Transportation roadside park on U.S. Highway 27, Ichetucknee Springs State Park, Columbia Co. 29°57'N; 82°47'W. *G. floridensis*; FSM 24884. *G. athearni* Clench & Turner, 1956; FSM 24885. Isoenzyme variation in these two samples was reported by Chambers (1978). At this site, these species are so similar that they were at first separable only on the basis of isoenzyme differences. *Goniobasis* sp. of Chambers (1978) is here referred to *G. athearni* based on conchological overlap with and isoenzyme similarities to that species in the Chipola River (site 10).

8. Blue Spring, Withlacoochee River at State Highway 6, Madison Co. 30°29'N; 83°15'W. *G. floridensis*. USNM 782348.

9. Apalachicola River, 0.5 km S of U.S. Highway 90 bridge, Gadsen Co. 30°42'N; 84°51'W. *G. albanyensis* Lea, 1864. Fig. 1E. FSM 24886.

10. Chipola River at State Highway 167, Jackson Co. 30°48'N; 85°13'W. *G. floridensis*, USNM 782352. *G. curvicostata* (Reeve, 1861), Fig. 1D; USNM 782357. *G. athearni*, Fig. 1C; FSM 24887.

11. Blue Hole Spring, Florida Caverns State Park, Jackson Co. 30°49'N; 85°14'W. *G. floridensis*. USNM 782351.

12. Spring Creek at State Highway 75, Jackson Co. 30°59'N; 82°25'W. *G. dickinsoni* Clench & Turner, 1956. USNM 782344.

13. Holmes Creek at State Highway 2, Jackson Co. 30°58'N; 85°32'W. Fig. 1G. *G. dickinsoni*. USNM 782345.

14. Wrights Creek at State Highway 177A, Holmes Co. 30°51'N; 85°46'W. USNM 782353. *G. floridensis* was also found at this site, but not in sufficient quantities for electrophoretic analysis.

15. Choctawhatchee River at U.S. Highway 90, Washington Co. 30°46'N; 85°50'W. *G. floridensis*. Fig. 1F. USNM 782347. Clench & Turner (1956) reported *G. clenchi* Goodrich, 1924 at this site. The only specimens found during this study were identical to *G. floridensis* from Holmes Creek and are therefore referred to that species.

The drainage systems in which these sites are located (Fig. 2) are the St. Johns River drainage (sites 1–3), the Withlacoochee River drainage (site 4), the Waccasassa River drainage (sites 5–6) the Suwannee River drainage (sites 7–8), the Apalachicola River drainage (sites 9–12) and the Choctawhatchee River drainage (sites 13–15). The Withlacoochee River listed above flows directly into the Gulf of Mexico and should not be confused with a river by that same name that is a tributary of the Suwannee River.

To facilitate reference to the figure, collection site numbers will follow names of sites when mentioned in the text of this paper.

*Collection and handling of animals.* *Goniobasis* was collected in the field by hand and by use of a bottom sampling net. The snails were sampled without regard to phenotype, even in highly variable populations. They were brought to the laboratory on the day of collection in unaerated jars or plastic boxes and placed in 38 l aquaria. When possible, aquaria were prepared weeks in advance of their occupation. These preparations included spreading aquarium bottoms with 2–3 cm of fine sand and inoculating the water with an algae and diatom culture. Occupied aquaria were aerated and supplied with individual outside filters. Survival was virtually complete if the aquaria were not overcrowded (typically about 30 snails in a 38 l aquarium) and dead snails were removed promptly.

Breeding experiments were attempted in order to verify genetic interpretations of gel staining patterns. Young *G. floridensis* about 2 mm in shell length were placed singly or paired in 19 l aquaria. These aquaria were prepared the same way as the holding aquaria, but without filtration. The breeding aquaria were placed under a 10 hr light-14 hr dark cycle from Gro-Lux fluorescent lights. The

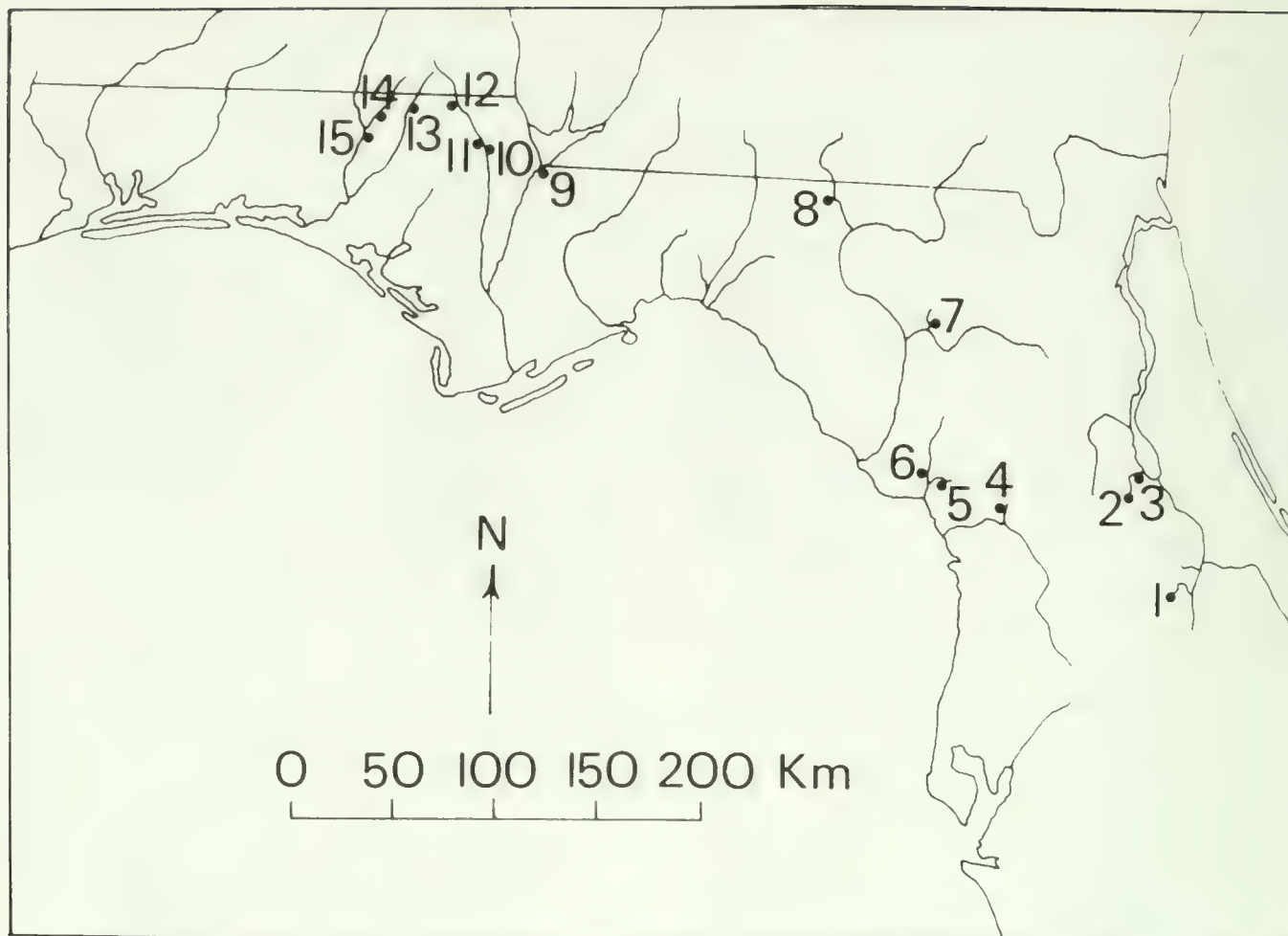

FIG. 2. Northern Florida localities where *Goniobasis* was sampled for electrophoretic analysis. The numbers correspond to those given in the text with the locality descriptions.

number of these breeding experiments has been limited by water volume requirements, the one year or longer generation time, and the difficulty in determining the sex of living *Goniobasis*.

**Electrophoresis.** Starch gel electrophoresis was performed on 52 individuals of each species from each locality. Sample preparation and electrophoretic methods were described in Chambers (1978). The enzymes studied (followed by the abbreviation of the locus or loci scored for each enzyme) are as follows: Acid phosphatase (*Acph-1*, *Acph-2*), aldolase (*Aldo*), alkaline phosphatase (*Aph*), esterase (*Est-1*, *Est-2*, *Est-3*), glutamate-oxalacetate transaminase (*Got*), glyceraldehyde-3-phosphate dehydrogenase (*G3pd*), hexanol dehydrogenase (*Hexdh*), leucine aminopeptidase (*Lap-1*, *Lap-2*), malic enzyme (*Me*), 6-phosphogluconate dehydrogenase (*6Pgd*), phosphoglucose isomerase (*Pgi*), phosphoglucumutase (*Pgm*), sorbitol dehydrogenase (*Sdh*), and tetrazolium oxidase (*To*). Individuals from at least two different populations, in addition to 4 individuals from the reference

population, were run on each gel to determine relative electrophoretic mobilities of enzymes. The reference population and *G. floridensis* from sites 4–7 were screened for the activity of 20 additional enzymes that were not used either because of lack of activity or inconsistent resolution. These enzymes are listed in Chambers (1977).

## RESULTS

The results of the electrophoretic analysis are presented in Table 1. Not included in the table are two monomorphic loci, *Est-1* and *To*. The data for both species at site 7 have been reported previously (Chambers, 1978). Gel patterns were scored as autosomal loci according to the criteria of Ayala et al. (1973). The most common allele, or electromorph, in the reference population (*G. athearni* at site 7) for each locus was designated with the superscript <sup>100</sup>, with other alleles designated by adding to 100 the number of mm a band migrates anodal to the standard, or by subtract-







ing the number of mm a band runs cathodal to the standard. The reference population was chosen for reasons discussed in Chambers (1978). Null alleles were scored at a locus when no staining was detected for an individual snail. In all cases of null alleles, non-null alleles could be scored on the same gel slice, and other slices from the same gel that were stained for a different enzyme showed normal enzyme activity for the same individual. The frequency of null alleles was calculated as the proportion of individuals in the sample with the null phenotype. Since heterozygous null alleles are not detectable by these methods, the frequencies of null alleles are underestimated.

Mendelian interpretations of gel staining patterns for all loci was consistent with the electrophoretic analysis of parental and  $F_1$  adults from two crosses of individuals from the Rainbow River (4) population of *G. floridensis* and a single cross between *G. floridensis* individuals from the Rainbow River (4) and Blue Spring (8). The phenotypes of these individuals are given in the Appendix. Three additional successful crosses were not studied electrophoretically since the progeny had not attained adult size by the time of the termination of the study. One of these crosses was between *G. floridensis* individuals from site 6 and the remaining two involved pairs from site 8. Twelve more crosses were unsuccessful because of the pairing of individuals of the same sex, discovered later; or death of one or both paired individuals before reaching adult size. Parental individuals in these 12 crosses included *G. floridensis* from sites 4, 6, and 8; and *G. vanhyningiana* from site 3. No evidence for asexual reproduction was found during these rearing studies since isolated females did not lay eggs until paired with a male.

In addition to the controlled crosses described above, individuals of *G. floridensis* (sites 4–6, 8 and 10), *G. vanhyningiana* (sites 1–3), and *G. dickinsoni* (sites 12 and 13) were reared from eggs layed in laboratory holding aquaria. In all cases, laboratory reared snails were conchologically identical to their field collected parents, except that spires were much less eroded in laboratory reared individuals. Since rearing conditions in the laboratory appeared to be uniform for all of these snails, development of shell sculpture patterns and color are apparently under genetic, and not environmental control.

Average genetic identity ( $I$ ) and distance

( $D$ ) over all loci, including those monomorphic, were computed between all samples according to the method of Nei (1972). These values are presented in Table 2. Standard errors of  $D$  (Nei & Roychoudhury, 1974) were about one-half of  $D$  for samples within the *G. floridensis* complex, and about one-third of  $D$  for more distantly related samples.

A dendrogram generated from the genetic distance matrix by the unweighted pair group method (Sneath & Sokal, 1973), recommended for use with electrophoretic data by Nei (1975), is presented in Fig. 3. The populations are divided into three major groups: One representing only *G. curvicostata*; a second consisting of *G. athearni* (including the reference population) and *G. albanyensis*; and the third group containing *G. floridensis*, *G. vanhyningiana*, and *G. dickinsoni*. The last group, the *G. floridensis* complex, is further subdivided into three clusters: (i) The Rock Spring (1), Juniper Spring (2), and Juniper Creek *Gonio-basis*(3), which are here considered to be *G. vanhyningiana* (see discussion below); (ii) the peninsular samples of *G. floridensis*; and (iii) the Florida panhandle samples of *G. floridensis* and *G. dickinsoni*. Within the final cluster note that *G. dickinsoni* does not form a distinct group, as the Spring Creek (12) sample is closer to the Chipola (10) and Choctawhatchee River (15) samples of *G. floridensis* than to other *G. dickinsoni* samples.

## DISCUSSION

The discussion will consist of four parts. First, a few general comments will be made on the interpretation and comparative value of electrophoretic data. Next, within drainage system genetic variation in the *G. floridensis* complex will be considered. Taxonomic recommendations based on the electrophoretic data will then be made. Finally, a gene diversity analysis of the electrophoretic data will be presented with the object of evaluating the effect of isolation of populations of the *G. floridensis* complex in different drainage systems.

### Electrophoretic methods

Certain biases inherent in electrophoretic methods must be considered when evaluating electrophoretic data. Perhaps the most important of these is that electrophoresis separates molecules on the basis of charge and conformational differences. Different molecules hav-



TABLE 2. Genetic identities (above the diagonal) and distances (below the diagonal) for 18 samples of *Goniobasis*. Populations are designated as in Table 1.

	<i>G. vanhyningiana</i>			<i>G. floridensis</i>						<i>G. dickinsoni</i>					Reference		<i>G. athearnii</i>	<i>G. albanensis</i>	<i>G. curvicaudata</i>
	1	2	3	4	5	6	7	8	10	11	15	12	13	14	7	10	9	10	
<i>G. vanhyningiana</i> 1	.995	.994	.891	.891	.768	.813	.773	.815	.753	.810	.760	.764	.717	.757	.309	.351	.349	.410	
2	.005	.999	.893	.893	.771	.818	.778	.792	.735	.807	.743	.748	.701	.741	.302	.326	.326	.380	
3	.005	.000	.893	.893	.773	.817	.776	.791	.740	.814	.748	.754	.706	.746	.303	.325	.326	.384	
4	.115	.112	.113	.883	.883	.929	.842	.886	.822	.853	.810	.807	.773	.771	.296	.346	.386	.397	
5	.264	.260	.257	.124	.924	.924	.829	.817	.801	.840	.802	.789	.757	.749	.338	.417	.414	.427	
6	.206	.201	.202	.073	.078	.133	.875	.861	.795	.837	.823	.803	.750	.745	.384	.428	.421	.390	
7	.257	.252	.253	.172	.188	.133	.213	.808	.769	.770	.730	.716	.684	.696	.363	.435	.417	.419	
8	.204	.233	.234	.120	.201	.149	.213	.881	.881	.870	.850	.859	.823	.827	.301	.345	.390	.439	
10	.283	.308	.301	.196	.221	.229	.262	.126	.068	.933	.954	.961	.948	.947	.345	.452	.492	.575	
11	.210	.214	.206	.158	.174	.177	.261	.138	.068	.941	.941	.938	.938	.948	.358	.358	.404	.488	
15	.273	.297	.289	.210	.220	.194	.313	.161	.046	.060	.991	.991	.934	.943	.361	.399	.430	.507	
12	.269	.290	.282	.214	.236	.219	.334	.151	.039	.063	.008	.930	.930	.944	.336	.379	.427	.570	
13	.333	.355	.348	.257	.278	.287	.380	.195	.053	.063	.068	.072	.991	.991	.297	.344	.388	.503	
14	.278	.299	.292	.260	.288	.294	.362	.189	.053	.053	.058	.057	.009	.297	.297	.341	.381	.514	
Reference	7	1.17	1.20	1.22	1.08	.958	1.01	1.20	1.06	1.03	1.02	1.09	1.21	1.21	.860	.860	.862	.263	
<i>G. athearnii</i>	10	1.05	1.12	1.12	1.06	.874	.831	1.06	.794	1.03	.919	.969	1.07	1.08	.150	.150	.901	.367	
<i>G. albanensis</i>	9	1.05	1.12	1.12	.950	.881	.863	.940	.707	.905	.842	.849	.947	.963	.147	.103	.313	.313	
<i>G. curvicaudata</i>	10	.892	.967	.957	.923	.851	.942	.869	.822	.552	.716	.678	.686	.665	1.33	1.00	1.16	1.16	

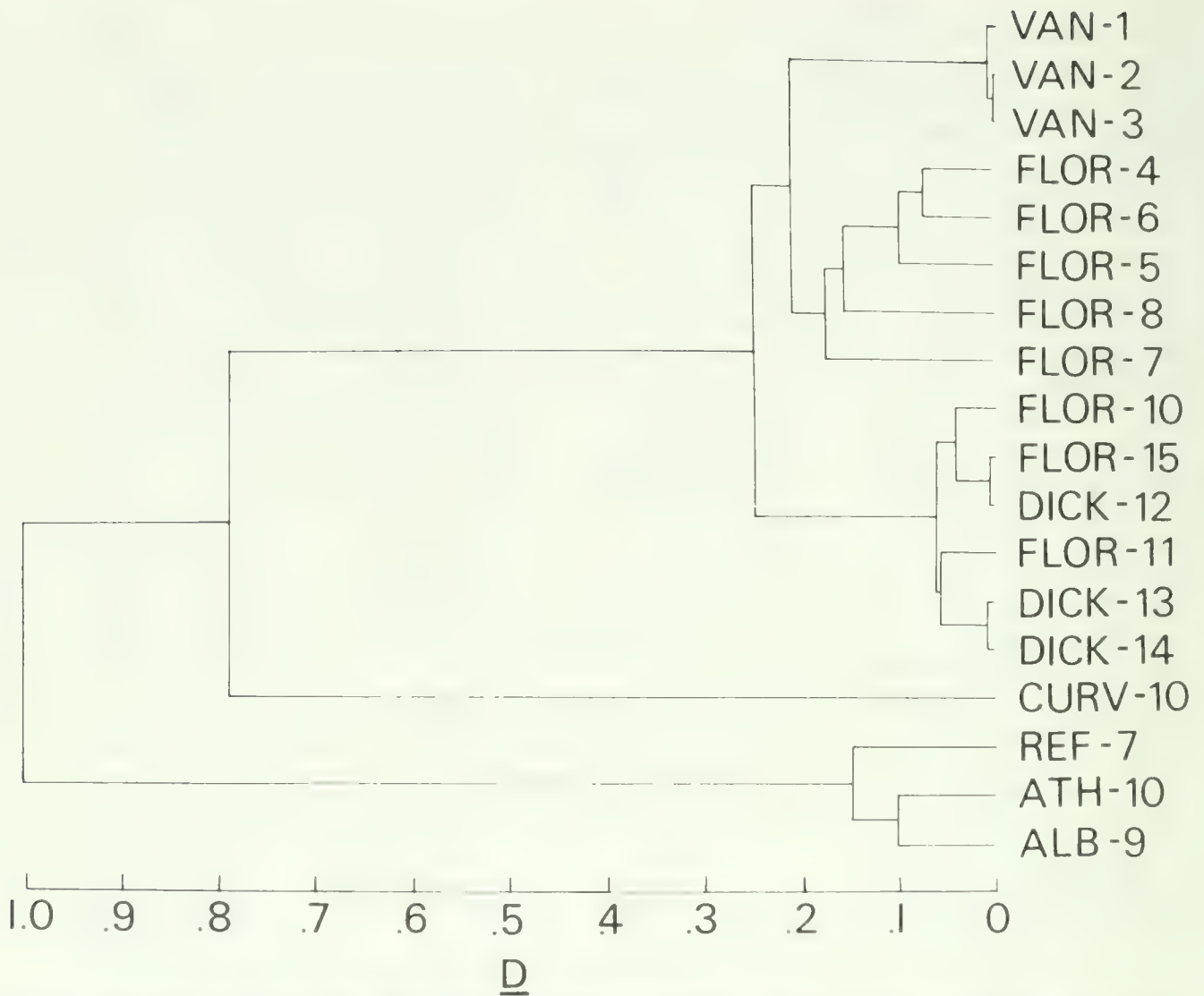

FIG. 3. Dendrogram computed from genetic distances between 18 samples of *Goniobasis*. Samples are identified by species abbreviation and site number. The reference population (REF) is here referred to *G. athearni* (see text).

ing the same net charge may be indistinguishable by the particular electrophoretic technique employed. Electrophoresis will therefore underestimate the amount of divergence between samples (Singh et al., 1976; Coyne, 1976; Coyne & Felton, 1977). Differences rather than similarities between samples should therefore be stressed when interpreting electrophoretic data. For a discussion of this and other biases, Lewontin (1974) should be consulted.

In spite of problems in interpreting electrophoretic data, there is a growing body of literature (reviewed by Ayala, 1975) that indicates a correlation between electrophoretically determined genetic divergence and taxonomic divergence. The group most extensively studied in this respect is the *Drosophila willistoni* group of fruit flies. Ayala et al. (1974) calculated average identity values ( $I$ ) of Nei (1972) for populations at varying degrees of

taxonomic distance. Local populations of the same subspecies tended to be quite similar with an average  $I$  of 0.970. Populations at increasing levels of taxonomic divergence showed decreasing identities. These values were, for samples of different subspecies, 0.795; different semispecies, 0.798; sibling species, 0.563, and nonsibling species, 0.352. Reviews of genetic divergence in other animals find general agreement with these values (Ayala, 1975; Avise, 1976). However, these taxonomic "standard"  $I$  values are averages based on a range of values, and studies on other organisms have occasionally detected full species with considerably higher identities (M. Johnson et al., 1977; D. Johnson, 1978) than the average  $I$  of 0.795 between subspecies of the *D. willistoni* group. The standard error of each calculated  $I$  is another factor that negatively affects the comparative value of genetic identities. Although

the average  $I$  values at different levels of taxonomic divergence in the *D. willistoni* group are useful standards for evaluating taxonomic divergence between populations of other organisms, taxonomic decisions based solely on such comparisons will often be erroneous.

Within drainage geographic variation  
in the *G. floridensis* complex

*St. Johns River Drainage:* Although they have been referred to two different species (Clench & Turner, 1956), the *Goniobasis* samples from this drainage are genetically very uniform. *G. vanhyningiana*, as originally described (Goodrich, 1921), differs from *G. floridensis* in its reduced shell sculpture on the adult whorls (Fig. 1B). Clench & Turner (1956) found no record of sympatry between these two species. The *Goniobasis* from Juniper Spring (2) have the same shell color and sculpture pattern as *G. vanhyningiana*, but were included with *G. floridensis* by Clench & Turner. About 6 km down Juniper Creek (3) from the spring, the *Goniobasis* have the "standard *G. floridensis* sculpture pattern" of spiral cords intersecting costae to form nodules (Fig. 1A, F). These individuals are also light brown in shell color. Between these sites, the two forms can be found together with a full range of intermediate forms (Fig. 4). The extremely high  $I$  values for *G.*

*vanhyningiana* from Rock Springs (1) and Juniper Spring (2) and Juniper Creek (3) samples (0.994 and 0.995) are well within the range of conspecific populations of the *D. willistoni* group (Ayala et al., 1974). Especially noteworthy is the virtual identity ( $I = 0.999$ ) between the Juniper Spring (2) and Juniper Creek (3) samples which differ so greatly in shell sculpture. All common alleles are shared by all three samples in this drainage except for *Aph*<sup>100</sup>, which was detected only in the Rock Springs (1) sample. If the specific status of *G. vanhyningiana* is to be maintained, it should include the Juniper Spring (2) and Juniper Creek (3) populations. The reproductive relationships of these three populations to *G. floridensis* from other drainages have not been determined, so the specific status of *G. vanhyningiana* is tentative.

*Waccasassa River drainage:* Two different shell forms of *G. floridensis* intergrade in this drainage. A smooth shelled form is found in the Waccasassa River (6). This form has definite costae, but lacks spiral cords. The Wekiva River, a branch of the Waccasassa River, contains a standard sculpture form. At the confluence of these rivers, these forms hybridize, with a full range of intermediate forms (Fig. 5). The  $I$  value for samples taken of these two forms is 0.924, which is well above the average  $I$  for conspecific populations of different subspecies of the *D. willistoni* group. All common alleles were found in



FIG. 4. *Goniobasis* from Juniper Creek, about midway between sites 2 and 3.



FIG. 5. *Goniobasis floridensis* from the Wekiva River at US Highway 19.

both samples, except that *Aph*<sup>100</sup> was absent from the Waccasassa River (6) sample, and there were sharp differences in allele frequencies at *Est-3* and *Me*. Morphological differentiation between the two forms has occurred without dramatic genetic differentiation.

**Suwannee River drainage:** There are pronounced differences at 4 loci between the two *G. floridensis* samples from the Suwannee River drainage. The samples from the Ichetucknee River (7) and Blue Spring (8) had no common alleles at three loci (*Acph-1*, *Acph-2*, and *Lap-1*) and *Aph*<sup>100</sup> had a frequency of 0.875 at Blue Spring and was absent from the Ichetucknee River sample. The apparent lack of gene flow between these two populations can be explained by the tannin-colored acidic waters of the intervening Withlacoochee River. Mollusks in general do not tolerate acid waters, and Florida *Goniobasis* seems to have a particularly strong preference for alkaline spring water (Beck, 1965). The overall identity between these two samples is  $I = 0.808$ , which is above the average value found between subspecies of the *D. willistoni* group.

**Apalachicola River drainage:** *G. floridensis* in this drainage varies in shell sculpture and appears to interbreed with a form referred to *G. dickinsoni* by Clench & Turner (1956).

An unusual population of *G. floridensis* in Blue Hole Spring (11) is characterized by individuals of large size with heavy costae and weak cords (Fig. 6G–K). The typical *G. floridensis* sculpture increases as the spring flows

towards the Chipola River. The *G. floridensis* found in the Chipola River (10) have the standard sculpture pattern. The samples from sites 10 and 11 share common alleles at all loci except *Aph* and *Lap-1*. At these two loci, each of the two samples has a common allele not found in the other sample. Although the allozyme evidence from these two loci argues against extensive gene flow between snails at these two sites, genetic divergence may be magnified by selection operating at these two loci. Since  $I = 0.933$  for these two samples, they are more similar than the average subspecies of the *D. willistoni* group. It is also possible that hybridization is recent or, as the morphological evidence suggests, is confined mainly to the vicinity of Blue Hole Spring (11).

Morphological evidence suggests that *G. floridensis* and *G. dickinsoni* are intergrading near the headwaters of the Chipola River. *G. dickinsoni* is characterized by a lack of shell sculpture. However, some *G. dickinsoni* shells in the Spring Creek (12) samples have faint indications of spiral cords (Fig. 6C, D). The frequency and expression of standard *G. floridensis* sculpture increases going down the Chipola River. The electrophoretic data from the Chipola River (10) sample of *G. floridensis* and the Spring Creek (12) sample of *G. dickinsoni* are compatible with the intergrade hypothesis. All common alleles are shared by the two samples except that *Lap-1*<sup>107</sup> has a frequency of 0.577 and *6Pgd*<sup>97</sup> has a frequency of 0.106 in the *G. dickinsoni* sample. Both alleles are absent from the Chipola River sample of *G. floridensis*. How-



FIG. 6. *Goniobasis* from the Chipola River drainage and Holmes Creek. A–B. *G. dickinsoni*, site 13. C–D, *G. dickinsoni*, site 12. E–F, *G. floridensis*, site 10. G–K, *G. floridensis*, site 11.

ever, allele frequencies in the Spring Creek (12) sample at *Got*, *Me*, and *Sdh* are more similar to those of Florida panhandle samples (10, 11, 15) of *G. floridensis* than to other *G. dickinsoni* samples. The heterozygosity of the Spring Creek (12) sample was twice that of the other *G. dickinsoni* samples. This would be an expected result of introgression from *G. floridensis*. Either *G. dickinsoni* and *G. floridensis* are interbreeding, and are therefore conspecific, in the Chipola River; or there has been recent massive introgression between these two species.

*Choctawhatchee River drainage:* Although *I* values for *G. floridensis* and *G. dickinsoni* in the Choctawhatchee River drainage (sites 13–15) are 0.934 and 0.943 and they are sympatric at site 14, there is no morphological evidence for hybridization between them (Fig. 7). The Choctawhatchee River drainage samples of these two species share all common alleles, except at *Me* where *Me*<sup>100</sup> has a

frequency of 0.490 in the *G. floridensis* sample and is absent from the *G. dickinsoni* samples.

#### Taxonomic implications

Electrophoretic methods alone cannot generate classification, but they can supply useful data for making subjective taxonomic decisions. One of the less subjective applications of these methods is in evaluating the probability of gene flow between sympatric or contiguous populations. For example, electrophoretic data give strong evidence against gene flow between *G. atearni* and *G. floridensis* in the Ichetucknee River (Chambers, 1978). In the present study, electrophoretic data are consistent with the hypothesis that *G. floridensis* and *G. dickinsoni* are interbreeding in the upper Chipola River. The conchologically different samples of *G. vanhyningiana* from sites 2 and 3 are so simi-



FIG. 7. *Goniobasis* from the Choctawhatchee River drainage. A-B. *G. dickinsoni*, site 14. C-D. *G. floridensis*, site 15.

lar in electrophoretically-detected allele frequencies that they could be considered as separate samples from a single population.

Electrophoretic data also appear to be useful in placing populations or forms into species groups. For example, each of the three major clusters in Fig. 3 may be thought of as representing a different species group. This ordering of species groups gives a different overall view of taxonomic affinities than that provided by the pioneering conchological work of Clench & Turner (1956). *G. atearni*, thought to be very closely related to *G. floridensis*, is biochemically very different and is closest to *G. albanyensis*. This *G. atearni*-*G. albanyensis* group is also distinct from *G. curvicastrata*, which was thought to have affinities to *G. albanyensis*.

The application of the electrophoretic data to populations within the *G. floridensis* complex, which includes *G. floridensis*, *G. dickinsoni*, and *G. vanhyningiana*, is much more subjective. This is an actively evolving assemblage of closely related forms that displays a range of internal relationships from populations that are clearly interbreeding to those that have apparently evolved reproductive isolation. The complexity of these interrelationships does not allow placement of all

forms neatly into one or more species. A study of reproductive relationships between these forms, as has been done with the equally complex *Drosophila willistoni* group (Ayala et al., 1974), might most accurately determine the biological species involved. However, given the difficulties and time required for rearing *Goniobasis*, it is unlikely that such an effort could be completed before extinction of many populations makes the question purely academic. Inferences based on electrophoretic data, as subjective as they might be, are therefore a reasonable alternative. The amount of taxonomic divergence between two populations can be estimated by comparing their genetic identity ( $I$ ) with the average identity values for various levels of taxonomic divergence in the *D. willistoni* group (Ayala et al., 1974), whose taxonomic divergence is known from reproductive studies. The following discussion will deal with the relationships of each of the named species within the *G. floridensis* complex.

*Goniobasis vanhyningiana* forms a distinct cluster within the *G. floridensis* complex (Fig. 3). The highest  $I$  values (0.891 and 0.893) between *G. vanhyningiana* samples and *G. floridensis* are with the *G. floridensis* sample from Rainbow River (4). These values are

well above the average  $I$  value of 0.795 for different subspecies of the *D. willistoni* group. However, these St. Johns River drainage forms are distinct from other members of the *G. floridensis* complex in their light brown shell color and chalky white color seen in the shell aperture. *G. vanhyningiana* and *G. floridensis* may be a case of reproductive isolation having been attained between populations with high genetic identities (M. Johnson et al., 1977; D. Johnson, 1978). Although reproductive studies may eventually indicate that *G. vanhyningiana* is a synonym of *G. floridensis*, the distinctiveness of *G. vanhyningiana* justifies its retention as a species at this time.

*Goniobasis dickinsoni* is found only in the headwaters of the Chipola River, Apalachicola River drainage, and some adjacent tributaries of the Choctawhatchee River drainage. Clench & Turner (1956) justifiably interpret this distribution as being the result of stream capture or mechanical dispersal in this area of low relief. The present study has reported evidence that this species is reproductively isolated from *G. floridensis* in one part of its range, the Choctawhatchee River drainage, but not in another, the Chipola River. Since they display incomplete reproductive isolation, *G. dickinsoni* and *G. floridensis* might be considered semispecies (Mayr, 1963). Mayr (1963) has observed that, if speciation is a gradual process, such intermediate cases should exist. An alternative interpretation is that *G. dickinsoni* in each drainage system has independently evolved similar shell characters, and that the population in the Chipola River is a smooth shelled form of *G. floridensis*. Preliminary evidence from karyotypic studies, currently in progress, supports this alternative interpretation. There is electrophoretic evidence of independent reduction in the expression of shell sculpture in *Goniobasis* in the St. Johns and Waccasassa River drainages (this study) and in *Goniobasis proxima* in eastern Virginia (Dillon & Davis, unpublished manuscript). Whichever evolutionary interpretation is correct, *G. dickinsoni* and *G. floridensis* in these two drainages are very closely related, with  $I$  values similar to those between local populations of the *D. willistoni* group. The only certain taxonomic decision that can be made is that *G. dickinsoni* and *G. floridensis* are "good" reproductively isolated species in the Choctawhatchee River drainage, even though genetic divergence ( $I = 0.934$  and  $0.943$ ) is less than that observed for average subspecies of the *D. willistoni* group.

The populations referred to *G. floridensis* in this study cannot be recognized as definite conspecifics based on electrophoretic analysis. The only populations known to be capable of interbreeding, Rainbow River (4) and Blue Spring (8), have a genetic identity of 0.886, which is above the average value for subspecies of the *D. willistoni* group. For the other populations, the electrophoretic data allow several alternative interpretations. The gene diversity analysis presented in the next section indicates that most of the genetic diversity in the *G. floridensis* complex is between drainage systems. The *G. floridensis* of each drainage can then be thought of as different evolutionary units or "populations" in the sense of Ehrlich & Raven (1969). An extreme taxonomic interpretation based on this finding would be to split *G. floridensis* into several species, with each species occupying a single drainage system. Another approach would be to recognize each of the two sub-clusters of *G. floridensis* as different species: One would occupy the Florida panhandle (sites 10, 11, and 15) and the other the Florida peninsula (sites 4–8). This would be an extremely arbitrary scheme since the range of identities between populations of the two presumptive species includes values above and below the average identity of semispecies of the *D. willistoni* group. It is probably safest to assume that *G. floridensis* (sites 4–8, 10, 11, 15, and possibly 12) is a single species, with the provision that some reproductive isolation may be discovered within the "species," most likely between peninsular and panhandle populations.

#### Apportionment of gene diversity in the *G. floridensis* complex

Genetic divergence between samples can be described using Nei's (1975) method of analyzing gene diversity in subdivided populations. This method partitions the total gene diversity into within subpopulation and between subpopulation diversity, and allows the computation of  $G_{ST}$ , the coefficient of gene differentiation.  $G_{ST}$  is the proportion of the total gene diversity ( $H_T$ ) attributed to the diversity among subpopulations ( $D_{ST}$ ), and approximates Wright's  $F_{ST}$  (Nei, 1975).

The terms "population," "subpopulation," and "colony" (used below) as used by Nei (1975), simply describe units in a hierarchy and may not correspond to traditional biological uses of the terms. For example, in one of Nei's (1975) analyses, "population" refers to

all humans of three major races with each race considered a separate subpopulation. In a separate analysis in the same chapter, "population" refers to all 37 villages of Yanomama Indians, with each village treated as a separate subpopulation.

If the 14 samples of the *G. floridensis* complex are treated as subpopulations,  $G_{ST}$  is 0.712. This is a large amount of diversity between samples as compared to  $G_{ST}$  values for other organisms (Nei, 1975). If the divergent St. Johns River drainage samples (*G. vanhyningiana*) are omitted,  $G_{ST}$  is still 0.654, which is exceeded only by the value of 0.674 for the Ord Kangaroo rat (*Dipodomys ordi*), the highest  $G_{ST}$  reported by Nei (1975).

High  $G_{ST}$  values describe only the relative amount of divergence between samples. The cause of this divergence may or may not involve reproductive isolation between samples. Since there is an overall correlation between genetic divergence and the attainment of reproductive isolation, extremely high  $G_{ST}$  values, such as that for the *G. floridensis* complex, indicate the possibility of some reproductive isolation within the complex.

Gene diversity can be even more finely partitioned if the subpopulations can themselves be subdivided into colonies (Nei, 1975). This relationship can be defined as:

$$H_T = H_C + D_{CS} + D_{ST},$$

where  $H_C$  is the gene diversity within colonies and  $D_{CS}$  is the gene diversity between colonies within subpopulations. This can be applied to the *G. floridensis* complex by considering drainage systems as subpopulations and each sample taken within these systems as a colony. The absolute values listed in Table 3 are the result of this analysis. These values are also presented as percentage of the total diversity ( $H_T$ ). The greatest proportion of the

gene diversity in the *G. floridensis* complex occurs between drainage systems ( $G_{ST} = 0.458$ ) and the smallest proportion between samples within drainages ( $G_{CS}$ ). The general conclusions are unchanged if the St. Johns drainage samples are omitted from the calculations ( $G_{ST} = 0.408$ ,  $G_{CS} = 0.233$ ). The between drainage proportion of gene diversity is largest even though the within drainage component includes divergent samples within the Suwannee River drainage and reproductively isolated populations of *G. floridensis* and *G. dickinsoni* in the Choctawhatchee River drainage.

The relative amount of within drainage genetic divergence in the *G. floridensis* complex seems low relative to that found in sunfish (Avisé & Smith, 1974). This might be expected based on the smaller sizes of drainage systems considered in the *Goniobasis* study, although the probably more limited within drainage dispersal abilities of *Goniobasis* should, to some extent, compensate for this. The drainages in the sunfish study were further subdivided by dams, which are apparently strong barriers to gene flow (Avisé & Felley, 1979).

A certain minimum amount of dispersal of *Goniobasis* between drainages is required to explain the occurrence of these snails in different river drainages. Geologically related mechanisms, such as stream capture, confluence of previously separate rivers by low sea level stands, and connection by underground caverns are possible factors. Flooding at the headwaters or mouths of adjacent rivers might provide an occasional avenue of dispersal. These mechanisms have apparently not occurred recently enough or frequently enough to keep populations in adjacent drainages from diverging genetically.

Passive overland dispersal is common in

TABLE 3. Summary of gene diversity analysis of samples of the *G. floridensis* complex occupying various drainage systems (see text).

	Including St. Johns drainage		Excluding St. Johns drainage	
	Absolute	Percent of total diversity	Absolute	Percent of total diversity
Within samples ( $H_C$ )	0.065	34.2	0.074	35.9
Within drainages ( $D_{CS}$ )	0.038	20.0*	0.048	23.3*
Between drainages ( $D_{ST}$ )	0.087	45.8**	0.084	40.8**
Total diversity ( $H_T$ )	0.190	100	0.206	100

\*Value of  $G_{CS} \times 100$

\*\*Value of  $G_{ST} \times 100$



many aquatic invertebrates (Maguire, 1963). Such dispersal in many of these animals is facilitated by their possession of desiccation-resistant cysts or eggs, which have not been found in *Goniobasis*. Members of the *G. floridensis* complex lay their eggs in sand-encrusted clusters on underwater plants, leaves, stones, and other snail shells. One of these items with attached eggs or embryos might occasionally be transported by wind or animal, but lack of desiccation-resistant egg adaptations would minimize the probability of successful dispersal by these means. Aquatic gastropods may be transported attached to insects or the feet and plumage of aquatic birds (Baker, 1945; Malone 1965a,b; Rees, 1965). However, the available evidence for these mechanisms is from pulmonate gastropods, which have the advantages of respiration by means of a lung and are often capable of self-fertilization. Dioecious reproduction in *Goniobasis* necessitates the transport of a gravid female or successful mating within the lifetime of the transported individual for there to be a chance of gene flow between drainages. *Goniobasis* respire by means of a gill, which means that respiratory efficiency is probably greatly reduced while the animal is removed from water. The reproductive and respiratory systems of *Goniobasis* and many other pleurocerid snails render them less likely overland colonists than most pulmonate snails.

The rarity of dispersal between drainages presents a sufficient explanation for the genetic divergence found between members of the *G. floridensis* complex occupying different drainage systems. Land barriers between populations have probably played a major role in promoting genetic divergence and the complex patterns of speciation observed in *Goniobasis* and other pleurocerid snails.

#### ACKNOWLEDGEMENTS

I am indebted to T. C. Emmel, M. D. Huetel, R. Franz, J. T. Giesel, M. Kreitman, and F. G. Thompson for their contributions to this study. R. T. Dillon and G. M. Davis kindly allowed me to read and cite their unpublished manuscript. Major Jim Stevenson of the Florida Division of Recreation and Parks granted permission to collect *Goniobasis* in Ichetucknee Springs State Park and Florida Caverns State Park. Financial support for this project

was provided by the Theodore Roosevelt Memorial Fund of the American Museum of Natural History, a Sigma Xi Grant-in-Aid of Research, and a National Science Foundation Grant for Improving Doctoral Dissertation Research in the Field Sciences.

#### LITERATURE CITED

- AVISE, J. C., 1976, Genetic differentiation during speciation, In: AYALA, F. J. (Ed.), *Molecular Evolution*. Sinauer Associates, Sunderland, Massachusetts, p. 106-122.
- AVISE, J. C. & FELLE, J., 1979, Population structure of freshwater fishes I. Genetic variation in bluegill (*Lepomis macrochirus*) populations in man-made reservoirs. *Evolution*, 33: 15-26.
- AVISE, J. C. & SMITH, M. H., 1974, Biochemical genetics of sunfish. I. Geographic variation and subspecific intergradation in the bluegill, *Lepomis macrochirus*. *Evolution*, 28: 42-56.
- AYALA, F. J., 1975, Genetic differentiation during the speciation process. In: DOBZHANSKY, T., HECHT, M. K. & STEERE, W. C. (Eds.), *Evolutionary Biology*. Plenum Press, New York. Volume 8: 1-78.
- AYALA, F. J. (Ed.), 1976, *Molecular Evolution*. Sinauer Associates, Sunderland, Massachusetts, 277 p.
- AYALA, F. J., HEDGECOCK, R., ZUMWALT, G. S. & VALENTINE, J. W., 1973, Genetic variation in *Tridacna maxima*, an ecological analog of some unsuccessful evolutionary lineages. *Evolution*, 27: 177-191.
- AYALA, F. J., TRACEY, M. L., HEDGECOCK, D. & RICHMOND, R. C., 1974, Genetic differentiation during the speciation process in *Drosophila*. *Evolution*, 28: 576-592.
- BAKER, F. C., 1945, *The Molluscan Family Planorbidae*. University of Illinois Press, Urbana, 530 p.
- BECK, W. M., 1965, The streams of Florida. *Bulletin of the Florida State Museum (Biological Sciences)*, 10: 91-126.
- CHAMBERS, S. M. 1977, *Genetic divergence during speciation in freshwater snails of the genus Goniobasis*. Ph.D. Dissertation, University of Florida.
- CHAMBERS, S. M., 1978, An electrophoretically detected sibling species of "*Goniobasis floridensis*." *Malacologia*, 17: 157-162.
- CLENCH, W. J. & TURNER, R. D., 1956. Freshwater mollusks of Alabama, Georgia, and Florida from the Escambia to the Suwannee River. *Bulletin of the Florida State Museum (Biological Sciences)*, 1: 97-239.
- COYNE, J. A., 1976, Lack of genic similarity between two sibling species as revealed by varied techniques. *Genetics*, 84: 593-607.
- COYNE, J. A. & FELTON, A. A., 1977, Genic

- heterogeneity at two alcohol dehydrogenase loci in *Drosophila pseudoobscura* and *Drosophila persimilis*. *Genetics*, 87: 285–304.
- DARWIN, C., 1860, *The Voyage of the Beagle*.
- ENGEL, L.(Ed.), 1962, The Natural History Library edition, Doubleday, Garden City, New York, 524 p.
- EHRlich, P. R. & RAVEN, P. H., 1969, Differentiation of populations. *Science*, 165: 1228–1232.
- GOODRICH, C., 1921, Three new species of Pleuroceridae. *Occasional Papers of the Museum of Zoology, University of Michigan*, 91: 2–8.
- HEDGEcock, D., 1978, Population subdivision and genetic divergence in the red-bellied newt, *Taricha rivularis*. *Evolution*, 32: 271–286.
- JOHNSON, D. L. E., 1978, Genetic differentiation in two members of the *Drosophila athabasca* complex. *Evolution*, 32: 798–811.
- JOHNSON, M. S., CLARKE, B. & MURRAY, J., 1977, Genetic variation and reproductive isolation in *Partula*. *Evolution*, 31: 116–126.
- LEWONTIN, R. C., 1974, *The genetic basis of evolutionary change*. Columbia University, New York, 346 p.
- MACARTHUR, R. H. & WILSON, E. O., 1967, *The theory of island biogeography*. Princeton University, Princeton, New Jersey, 203 p.
- MAGUIRE, B., Jr., 1963, The passive dispersal of small aquatic organisms and their colonization of isolated bodies of water. *Ecological Monographs*, 33: 161–185.
- MALONE, C. R., 1965a, Killdeer (*Charadrius vociferus* Linnaeus) as a means of dispersal for aquatic gastropods. *Ecology*, 46: 551–552.
- MALONE, C. R., 1965b, Dispersal of aquatic gastropods via the intestinal tract of water birds. *Nautilus*, 78: 135–139.
- MAYR, E., 1963, *Animal species and evolution*. Belknap, Cambridge, Massachusetts, 797 p.
- MERRITT, R. B., ROGERS, J. F. & KURZ, B. J., 1978, Genic variability in the longnose dace, *Rhinichthys cataractae*. *Evolution*, 32: 116–124.
- NEI, M., 1972, Genetic distance between populations. *American Naturalist*, 106: 283–292.
- NEI, M., 1975, *Molecular population genetics and evolution*. North-Holland, New York, 299 p.
- NEI, M. & ROYCHOUDHURY, A. K., 1974, Sampling variances of heterozygosity and genetic distance. *Genetics*, 76: 379–390.
- REES, W. J., 1965, The aerial dispersal of Mollusca. *Proceedings of the Malacological Society of London*, 36: 269–282.
- SINGH, R. S., LEWONTIN, R. C. & FELTON, A. A., 1976, Genetic heterogeneity within electrophoretic "alleles" of xanthine dehydrogenase in *Drosophila pseudoobscura*. *Genetics*, 84: 609–629.
- SNEATH, P. H. A. & SOKAL, R. R., 1973, *Numerical taxonomy*. Freeman, San Francisco, 573 p.

## APPENDIX

Electrophoretic analysis of *Goniobasis floridensis* crosses

Electrophoretic phenotypes at 18 loci of parental and F<sub>1</sub> individuals from three crosses are presented below. In parenthesis are the numbers of F<sub>1</sub> individuals with the stated phenotype.

## Cross no. 1: Rainbow River (site 4) × Rainbow River (site 4)

Parental		F <sub>1</sub>
♀	♂	
<i>Acp</i> <i>h</i> -1 <sup>107</sup>	<i>Acp</i> <i>h</i> -1 <sup>107</sup>	<i>Acp</i> <i>h</i> -1 <sup>107</sup> (12)
<i>Acp</i> <i>h</i> -2 <sup>103</sup>	<i>Acp</i> <i>h</i> -2 <sup>103</sup>	<i>Acp</i> <i>h</i> -2 <sup>103</sup> (12)
<i>Aldo</i> <sup>94</sup>	<i>Aldo</i> <sup>94</sup>	<i>Aldo</i> <sup>94</sup> (12)
<i>Aph</i> <sup>102</sup>	<i>Aph</i> <sup>102</sup>	<i>Aph</i> <sup>102</sup> (12)
<i>Est</i> -1 <sup>100</sup>	<i>Est</i> -1 <sup>100</sup>	<i>Est</i> -1 <sup>100</sup> (12)
<i>Est</i> -2 <sup>95</sup>	<i>Est</i> -2 <sup>95</sup>	<i>Est</i> -2 <sup>95</sup> (12)
<i>Est</i> -3 <sup>100</sup>	<i>Est</i> -3 <sup>100</sup>	<i>Est</i> -3 <sup>100</sup> (12)
<i>Got</i> <sup>93</sup>	<i>Got</i> <sup>93</sup>	<i>Got</i> <sup>93</sup> (12)
<i>G3pd</i> <sup>95</sup>	<i>G3pd</i> <sup>95</sup>	<i>G3pd</i> <sup>95</sup> (12)
<i>Hexdh</i> <sup>100</sup>	<i>Hexdh</i> <sup>100</sup>	<i>Hexdh</i> <sup>100</sup> (12)
<i>Lap</i> -1 <sup>104</sup>	<i>Lap</i> -1 <sup>104</sup>	<i>Lap</i> -1 <sup>104</sup> (12)
<i>Lap</i> -2 <sup>102</sup>	<i>Lap</i> -2 <sup>102</sup>	<i>Lap</i> -2 <sup>102</sup> (12)
<i>Me</i> <sup>102</sup>	<i>Me</i> <sup>102</sup>	<i>Me</i> <sup>102</sup> (12)
<i>6Pgd</i> <sup>109</sup>	<i>6Pgd</i> <sup>109</sup>	<i>6Pgd</i> <sup>109</sup> (12)
<i>Pgi</i> <sup>100</sup>	<i>Pgi</i> <sup>100</sup>	<i>Pgi</i> <sup>100</sup> (12)
<i>Pgm</i> <sup>101</sup>	<i>Pgm</i> <sup>101</sup>	<i>Pgm</i> <sup>101</sup> (12)
<i>Sdh</i> <sup>98</sup>	<i>Sdh</i> <sup>98</sup>	<i>Sdh</i> <sup>98</sup> (12)
<i>To</i> <sup>100</sup>	<i>To</i> <sup>100</sup>	<i>To</i> <sup>100</sup> (12)

Cross no. 2: Rainbow River (site 4) × Rainbow River (site 4)

Parental		F <sub>1</sub>
♀	♂	
<i>Acph-1</i> <sup>107</sup>	<i>Acph-1</i> <sup>107</sup>	<i>Acph-1</i> <sup>107</sup> (8)
<i>Acph-2</i> <sup>103</sup>	<i>Acph-2</i> <sup>103</sup>	<i>Acph-2</i> <sup>103</sup> (8)
<i>Aldo</i> <sup>94</sup>	<i>Aldo</i> <sup>94</sup>	<i>Aldo</i> <sup>94</sup> (8)
<i>Aph</i> <sup>102</sup>	<i>Aph</i> <sup>102</sup>	<i>Aph</i> <sup>102</sup> (8)
<i>Est-1</i> <sup>100</sup>	<i>Est-1</i> <sup>100</sup>	<i>Est-1</i> <sup>100</sup> (8)
<i>Est-2</i> <sup>95</sup>	<i>Est-2</i> <sup>95</sup>	<i>Est-2</i> <sup>95</sup> (8)
<i>Est-3</i> <sup>100</sup>	<i>Est-3</i> <sup>100</sup>	<i>Est-3</i> <sup>100</sup> (8)
<i>Got</i> <sup>93</sup>	<i>Got</i> <sup>93</sup>	<i>Got</i> <sup>93</sup> (8)
<i>G3pd</i> <sup>95</sup>	<i>G3pd</i> <sup>95</sup>	<i>G3pd</i> <sup>95</sup> (8)
<i>Hexdh</i> <sup>100</sup>	<i>Hexdh</i> <sup>100</sup>	<i>Hexdh</i> <sup>100</sup> (8)
<i>Lap-1</i> <sup>104</sup>	<i>Lap-1</i> <sup>102/104</sup>	<i>Lap-1</i> <sup>104</sup> (3), <i>Lap-1</i> <sup>102/104</sup> (5)
<i>Lap-2</i> <sup>102</sup>	<i>Lap-2</i> <sup>102</sup>	<i>Lap-2</i> <sup>102</sup> (8)
<i>Me</i> <sup>102</sup>	<i>Me</i> <sup>102</sup>	<i>Me</i> <sup>102</sup> (8)
<i>6Pgd</i> <sup>109</sup>	<i>6Pgd</i> <sup>109</sup>	<i>6Pgd</i> <sup>109</sup> (8)
<i>Pgi</i> <sup>100</sup>	<i>Pgi</i> <sup>100</sup>	<i>Pgi</i> <sup>100</sup> (8)
<i>Pgm</i> <sup>101</sup>	<i>Pgm</i> <sup>101</sup>	<i>Pgm</i> <sup>101</sup> (8)
<i>Sdh</i> <sup>98</sup>	<i>Sdh</i> <sup>98</sup>	<i>Sdh</i> <sup>98</sup> (8)
<i>To</i> <sup>100</sup>	<i>To</i> <sup>100</sup>	<i>To</i> <sup>100</sup> (8)

Cross no. 3: Rainbow River (site 4) × Blue Spring (site 8)

Parental		F <sub>1</sub>
♀	♂	
<i>Acph-1</i> <sup>107</sup>	<i>Acph-1</i> <sup>95</sup>	<i>Acph-1</i> <sup>95/107</sup> (7)
<i>Acph-2</i> <sup>103</sup>	<i>Acph-2</i> <sup>103/105</sup>	<i>Acph-2</i> <sup>103</sup> (4), <i>Acph-2</i> <sup>103/105</sup> (3)
<i>Aldo</i> <sup>94</sup>	<i>Aldo</i> <sup>94</sup>	<i>Aldo</i> <sup>94</sup> (7)
<i>Aph</i> <sup>102</sup>	<i>Aph</i> <sup>100</sup>	<i>Aph</i> <sup>100/102</sup> (7)
<i>Est-1</i> <sup>100</sup>	<i>Est-1</i> <sup>100</sup>	<i>Est-1</i> <sup>100</sup> (7)
<i>Est-2</i> <sup>95</sup>	<i>Est-2</i> <sup>95</sup>	<i>Est-2</i> <sup>95</sup> (7)
<i>Est-3</i> <sup>100</sup>	<i>Est-3</i> <sup>100</sup>	<i>Est-3</i> <sup>100</sup> (7)
<i>Got</i> <sup>93</sup>	<i>Got</i> <sup>93</sup>	<i>Got</i> <sup>93</sup> (7)
<i>G3pd</i> <sup>95</sup>	<i>G3pd</i> <sup>95</sup>	<i>G3pd</i> <sup>95</sup> (7)
<i>Hexdh</i> <sup>100</sup>	<i>Hexdh</i> <sup>100</sup>	<i>Hexdh</i> <sup>100</sup> (7)
<i>Lap-1</i> <sup>104</sup>	<i>Lap-1</i> <sup>null</sup>	<i>Lap-1</i> <sup>104</sup> (7)
<i>Lap-2</i> <sup>102</sup>	<i>Lap-2</i> <sup>102</sup>	<i>Lap-2</i> <sup>102</sup> (7)
<i>Me</i> <sup>102</sup>	<i>Me</i> <sup>102</sup>	<i>Me</i> <sup>102</sup> (7)
<i>6Pgd</i> <sup>109</sup>	<i>6Pgd</i> <sup>105/109</sup>	<i>6Pgd</i> <sup>105/109</sup> (5), <i>6Pgd</i> <sup>109</sup> (2)
<i>Pgi</i> <sup>100</sup>	<i>Pgi</i> <sup>100</sup>	<i>Pgi</i> <sup>100</sup> (7)
<i>Pgm</i> <sup>100/101</sup>	<i>Pgm</i> <sup>100</sup>	<i>Pgm</i> <sup>101</sup> (3), <i>Pgm</i> <sup>100/101</sup> (4)
<i>Sdh</i> <sup>98</sup>	<i>Sdh</i> <sup>98</sup>	<i>Sdh</i> <sup>98</sup> (7)
<i>To</i> <sup>100</sup>	<i>To</i> <sup>100</sup>	<i>To</i> <sup>100</sup> (7)



## THE GONIOBASIS OF SOUTHERN VIRGINIA AND NORTHWESTERN NORTH CAROLINA: GENETIC AND SHELL MORPHOMETRIC RELATIONSHIPS<sup>1</sup>

Robert T. Dillon, Jr.<sup>2</sup> and George M. Davis<sup>3</sup>

### ABSTRACT

Three species of *Goniobasis* inhabiting the upper New River and surrounding drainages, *G. proxima*, *G. semicarinata*, and *G. simplex*, were found to be very distinct using starch gel electrophoresis. Heterozygosity (H) is low, averaging 0.0113 across 12 populations and 15 loci. The average genetic identity (Nei, 1972) between conspecific populations is 0.89, also very low compared to averages recorded in other animals. Much of the difference between conspecific populations is due to fixation of alternative alleles, suggesting that gene flow even among populations connected through water can be quite low, or that selection is high. Three races are provisionally recognized in both *G. proxima* and *G. semicarinata* on the basis of differences in isozyme frequencies. Compared to electrophoresis, species identification using shell morphology alone was found to be unreliable. A population indistinguishable from *G. simplex* after a multidimensional scaling based on seven shell characters was revealed to be *G. proxima* using electrophoresis. The unusual shell morphology of this population may result from the introduction of the normally softwater-dwelling *G. proxima* into a hard-water stream similar to those inhabited by *G. simplex*. If divergence is measured as euclidean distance to species centroid after multidimensional scaling, the amount of population divergence in shell character is correlated to the amount of genetic divergence at the .05 level.

### INTRODUCTION

Pleurocerid snails (freshwater proso-branches) have undergone an extensive endemic radiation in streams and rivers of southeastern U.S.A. A bewildering variety of shell phenotypes has been the basis for some 500 nominal species (review of Tryon, 1873; Goodrich, 1940, 1941, 1942, 1944). The description of so many phenotypes has posed tremendous problems to taxonomists working with these mollusks.

Centers of gastropod endemism have provided areas for the study of adaptive radiation, speciation, and divergence. Some examples of such studies involve the pulmonate land snail genera *Partula* (Murray & Clarke, 1968) and *Cerion* (Gould & Woodruff, 1978), and the freshwater prosobranch Triculinae (Davis, 1979). This study deals with some members of the pleurocerid genus *Goniobasis* in parts of four drainages on the northern edge of their area of endemism.

The upper New River drains a sparsely populated, mountainous region on the border of Virginia and North Carolina. In an earlier

survey (Dillon, 1977), several species of the freshwater snail genus *Goniobasis* (Pleuroceridae) were found common and widespread in small streams and tributaries of the drainage but absent from the main bed of the New River (Fig. 1). The tendency for *Goniobasis* populations to diminish downstream is widespread and has been shown previously in *G. proxima* by Foin (1971) and Foin & Stiven (1970). In a survey of a single *G. proxima* population, Dillon (unpublished) found snail densities over 300 per square meter in a stream only one meter wide. Snail density gradually decreased to less than two per square meter by the time the stream was five meters wide, five kilometers downstream. Dispersal further downstream, between isolated populations, probably occurs only when snails are dislodged by flooding. Eggs are cemented firmly onto rocks, and individual snails generally move against the current (Crutchfield, 1966; Krieger & Burbanck, 1976).

Although the New River is quite ancient geologically (Ross, 1969), observed *Goniobasis* distributions probably date only from the

<sup>1</sup>This work was supported, in part, by a NSF Grant to G. M. Davis, No. DEB 78-01550.

<sup>2</sup>Department of Malacology, Academy of Natural Sciences of Philadelphia, and Department of Biology, University of Pennsylvania, Philadelphia, PA 19103-19104, U.S.A.

<sup>3</sup>Department of Malacology, Academy of Natural Sciences of Philadelphia, Philadelphia, PA 19103, U.S.A.

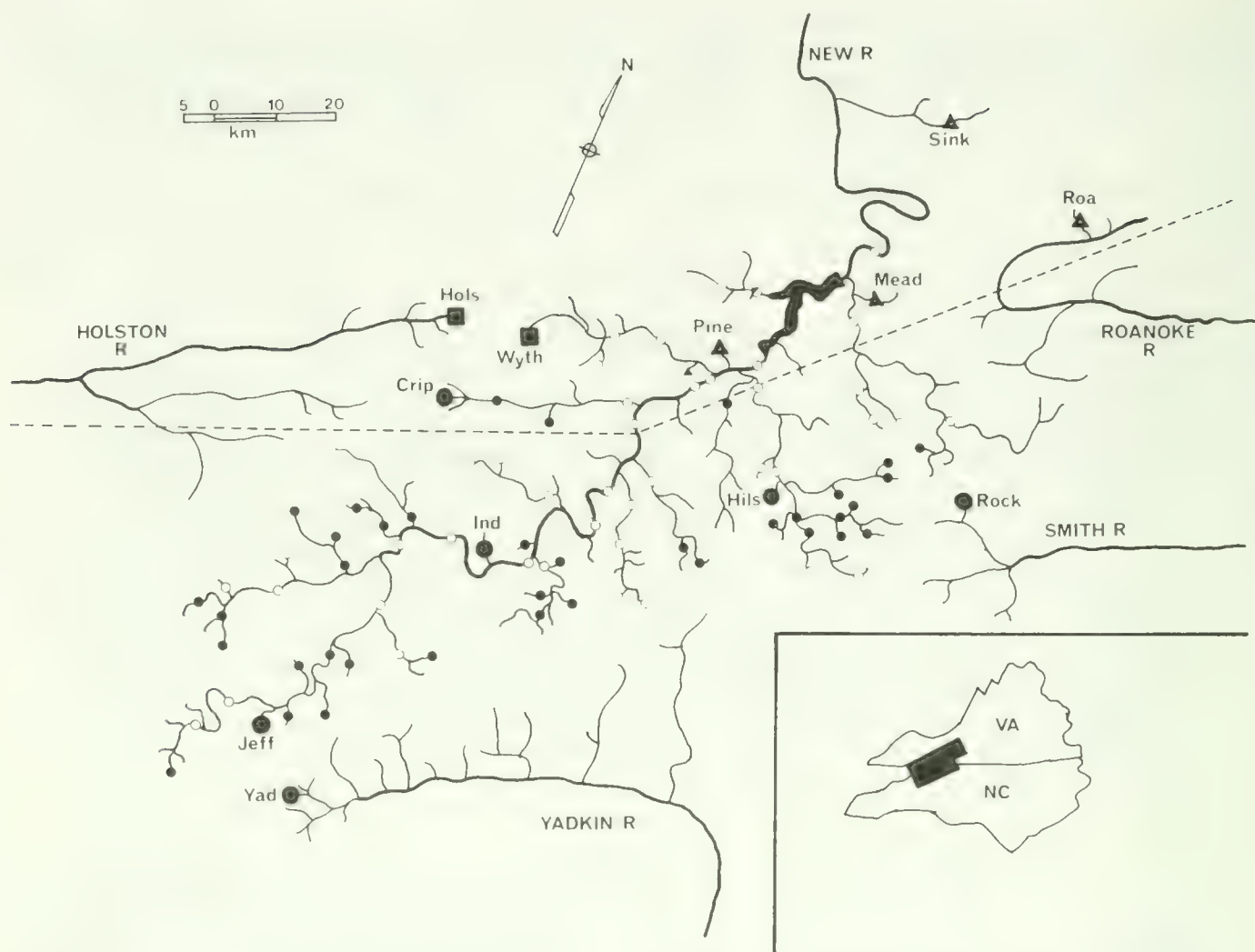

FIG. 1. Schematized map of the 5 drainage systems in the study area. Darkened symbols indicate presence of *Goniobasis*: circles, *G. proxima*; triangles, *G. semicarinata*; squares, *G. simplex*. Open circles are sites where no *Goniobasis* were collected by Dillon (1977). The 12 larger symbols designate the locations of population sampled for this study. The dashed line approximates the southeastern extent of limestone and dolomite.

Pleistocene. The heavy rains, high erosion rates, and lowered temperatures that accompanied worldwide climatic change probably affected the ranges of mountain stream-dwelling organisms greatly. Currently, the main body of the New River forms a barrier fragmenting the range of *Goniobasis* into numerous, isolated populations. To some extent these events must have been repeated in other rivers of the southeastern U.S.A., from which scores of pleurocerid species have been described. The erection of barriers to gene flow, while surely not the sole method of animal speciation (Bush, 1975; White, 1978; Futuyma, 1979), has probably played an important role in pleurocerid radiation. One objective of this study is to assess the impact of barriers to dispersal between *Goniobasis* populations.

Electrophoretic investigation of this interesting system has been initiated by Cham-

bers (1977, 1978, 1980). He has found that genetic divergence among consubspecific populations of *Goniobasis* in scattered Florida rivers is greater than the divergence in *Drosophila* populations reported by Ayala et al. (1974). Chambers found heterozygosity quite low in the 18 populations he surveyed and conspecific populations occasionally fixed for alternative alleles at particular loci. This suggests that migration among *Goniobasis* populations may be rare. Does migration seem to be as uncommon among *Goniobasis* isolated within the same river system as it seems between rivers? The second objective of this study is to assess the amount of genetic similarity within and between populations of the three *Goniobasis* species found in the upper New River, *G. proxima* (Say), *G. semicarinata* (Say), and *G. simplex* (Say), and compare these populations to conspecific populations in adjacent drainages.

Species identities of North American pleurocerids have been based entirely on shell characters. Many authors (cf. Dazo, 1965) have observed great variability in the shells of pleurocerids and suggested that varying environments are responsible. A great deal of interpopulation variability is apparent in the shells of the three *Goniobasis* species examined in this study. How do shell characters compare with electrophoretic data in distinguishing between species and populations? The third objective of this study is to examine the relationship between electrophoretic and shell morphological data.

## METHODS

### Populations studied

Eight populations of *Goniobasis* were selected to represent the geographic and morphological range of the genus in the upper New River. Four populations were chosen from surrounding drainages for comparison (Fig. 2). These populations represent three species, *Goniobasis proxima*, *Goniobasis semicarinata* and *Goniobasis simplex*. Species identifications were based on conchological comparisons with Tryon (1873) and collections in the Academy of Natural Sciences of Philadelphia. As will be shown later, conchological comparisons are no sure method of determining species status. Collection sites are shown in Fig. 1. Populations of *G. proxima* were given the names CRIP, HILL, IND, JEF, ROCK, and YAD, populations of *G. semicarinata* were designated MEAD, PINE, ROA, and SINK, and those of *G. simplex* were designated HOLS and WYTH. Locality data for the 12 populations are presented in the Appendix.

At least 100 large individuals were randomly collected at each site in September, 1978. Snails were kept alive in cloth sacks submerged under water in a large bucket in order to clean the guts of contents; the water was changed periodically for 24 hours. They were then quickly frozen (around  $-20^{\circ}\text{C}$ ) and kept in the freezer during the course of the study. Voucher specimens have been deposited in the Academy of Natural Sciences of Philadelphia; voucher specimen catalog numbers are given in the Appendix.

Although the geology of the study area is complex, limestone and dolomite generally underlie regions northwest of the dashed line in Fig. 1. Southeast of the line, the surface



FIG. 2. Representative shells from the *Goniobasis* populations surveyed. a, b, *G. simplex*; c-h, *G. proxima*; i-l, *G. semicarinata*. a—HOLS, b—WYTH, c—CRIP, d—HILL, e—IND, f—YAD, g—JEFF, h—ROCK, i—MEAD, j—ROA, k—PINE, l—SINK. Length of shell "a" 1.65 cm; remaining shells to same scale. See Fig. 1.

geology is principally gneiss and schist. Since it has been demonstrated that the distributions of freshwater mollusks can be highly influenced by the effects of limestone on water quality (Shoup, 1943; McKillop & Harrison, 1972; Dussart, 1976), alkalinity was measured at each of the 12 sites. Sepkoski & Rex (1974) have found a correlation between alkalinity ("bicarbonate ion concentration" and calcium concentration, hardness, pH, and total dissolved solids at the .01 level. All of these variables tend to increase in value as a drainage area includes more limestone and dolomite. Alkalinity measurements were made at the riverbank by staining 50 ml of water first with phenolphthalein and then with methyl purple, and titrating with .02N sulfuric acid (American Public Health Association, 1976).

TABLE 1. Means for shell characters measured on 20 individuals from each of 12 *Goniobasis* populations. Directly below each mean is the standard error of the mean.

	HILL	IND	JEFF	YAD	ROCK	CRIP	PINE	MEAD	SINK	ROA	WYTH	HOLS
Shell length (cm)	1.515 .023	1.488 .023	1.358 .019	1.439 .018	1.293 .017	1.707 .016	1.613 .024	1.535 .018	1.409 .015	1.586 .018	1.759 .029	1.532 .015
Body whorl length (cm)	1.142 .016	1.128 .015	1.015 .014	1.038 .011	.942 .012	1.310 .015	1.179 .017	1.113 .014	1.022 .012	1.161 .023	1.352 .020	1.188 .012
Aperture width (cm)	.382 .009	.361 .015	.338 .008	.320 .004	.281 .004	.468 .006	.377 .006	.348 .004	.340 .011	.367 .008	.442 .004	.423 .006
Spire angle (degrees)	22.8 .50	20.5 .63	19.7 .76	17.9 .60	15.6 .58	25.6 .53	20.9 .86	17.0 .49	20.9 .59	17.4 .77	27.7 .77	25.5 1.04
Shell length/Shell width	2.145 .020	2.146 .017	2.118 .023	2.248 .018	2.255 .027	2.075 .013	2.178 .021	2.289 .016	2.170 .012	2.359 .024	2.067 .021	2.015 .017
Third whorl width/Shell width	.535 .077	.570 .013	.546 .011	.600 .008	.594 .011	.494 .008	.565 .007	.582 .008	.564 .006	.585 .007	.495 .011	.450 .009
Aperture length/Shell length	.428 .004	.427 .006	.412 .006	.378 .003	.376 .004	.454 .004	.386 .005	.401 .005	.412 .005	.408 .006	.439 .004	.460 .005



## Shell morphometrics

Twenty large snails were chosen from the collection made at each site for shell morphology measurements. The seven measurements made on each shell are listed in Table 1. Spire angle, aperture length, shell width, and length of body whorl were measured with calipers using the methods of Davis (1969). Shell length was measured as the length of the last three whorls only, since shell apices were often eroded. Aperture width was the maximum distance across the aperture perpendicular to the measure of aperture length. The width of the third whorl up from the aperture was measured. Shell width, aperture length, and third whorl width were converted into ratios for an analysis of shape.

## Electrophoresis

Horizontal starch gel electrophoresis was performed using the procedure described by Ayala et al. (1973). The shells of individual snails were crushed using a pair of pliers and picked from the body with forceps. Then each body was placed in a centrifuge tube with 0.5 ml deionized water and homogenized by sonication. Small tabs of Whatman No. 3 filter paper were dipped in the crude homogenate, blotted, and applied to the gel. Gels were prepared using 35 g of Electrostarch and 250 ml of one of 3 gel buffers. Table 2 shows the compositions of both the gel buffers and the buffers used in the electrode trays. Gels were run at 35 milliamps or 350 volts, but not exceeding either.

TABLE 2. Buffers used in gels and electrode trays. Concentration of ingredients (Molarity).

Buffer, pH	Tris	Citric acid (mono-hydrate)	Boric acid	Na <sub>2</sub> EDTA
Tris-Cit 6 Tray	.237	.085		
Gel	.0083	.0030		
TEB 8 Tray	.500		.645	.0179
Gel	.050		.097	.0018
TEB 9.1 Tray & Gel	.087		.0087	.0011

After electrophoresis, the gels were sliced and stained for one of 15 enzymes (Table 3). Gel scoring methods were those of Ayala et al. (1973). The following are stain buffers and other standard components of the stains employed along with an abbreviated name for each. "0.1 Tris HCl buffer"—0.1 molar tris (hydroxymethyl) aminomethane ("Tris") adjusted to pH 7.95 with concentrated HCl. "0.2 Tris HCl buffer"—the same but 0.2M Tris. "DH buffer"—0.102M Tris, adjusted to pH 8.4 with concentrated HCl. "Tris maleate A"—0.2M Tris, 0.2M maleic acid. "Tris maleate B"—0.2M NaOH. "NAD"—0.05 ml of a 3% solution. "NADP"—0.05 ml of a 2.5% solution. "MgCl<sub>2</sub>"—1 drop of a 1% solution. "MTT"—0.05 ml of a 40 mg/ml suspension of 3-(4,5 dimethylthiazolyl-2)-2,5 diphenyl tetrazolium bromide. "PMS"—about 0.1 mg of phenazine methosulfate. "Agar"—10 ml of a 2 g/100 ml solution. "G6PdH" and "PGI"—5  $\mu$ l of a 1000 units/ml solution of glucose-6-

TABLE 3. Enzymes surveyed in *Goniobasis* populations.

Enzyme	Abbreviation	Buffer system	Run time (hr.)
Acid phosphatase	Acph	TEB 9.1	3
Aspartate aminotransferase	Aat	TEB 9.1	3
Glucose-6-phosphate dehydrogenase	G6pd	TEB 9.1	4
Glucose phosphate isomerase	Gpi	Tris-Cit 6	3
Hexanol dehydrogenase	Hexdh	TEB 9.1	4
Isocitrate dehydrogenase	Isdh	TEB 8	3
Leucine aminopeptidase	Lap	TEB 9.1	3
Malate dehydrogenase	Mdh	Tris-Cit 6	2
Mannose-6-phosphate isomerase	Mpi	Tris-Cit 6	3
Octopine dehydrogenase	Odh	Tris-Cit 6	3
6-Phosphogluconate dehydrogenase	6Pgd	Tris-Cit 6	2
Phosphoglucomutase	Pgm	Tris-Cit 6	2
Sorbitol dehydrogenase	Sdh	TEB 9.1	4
Superoxide dismutase	Sod	TEB 9.1	4
Xanthine dehydrogenase	Xdh	TEB 8	3

phosphate dehydrogenase and phosphoglucose isomerase, respectively.

Descriptions of the staining procedures employed follow, with standard recipe components referenced by their abbreviated names above. Most recipes have been modified from Shaw & Prasad (1970) and Bush & Huettel (1972).

AcpH— $\alpha$ -naphthyl acid phosphate 16 mg, Fast Blue BB salt 20 mg,  $MgCl_2$ . Tris maleate A 2.5 ml, Tris maleate B 1.3 ml, water 6.2 ml, Agar.

Aat—L-aspartic acid 400 mg,  $\alpha$ -ketoglutaric acid 200 mg, Fast Blue BB salt 300 mg, pyridoxal-5'-phosphate 0.5 mg, 0.2 Tris HCl buffer 100 ml.

G6pd—D-glucose-6-phosphate 20mg, NADP,  $MgCl_2$ , MTT, PMS, 0.1 TrisHCl buffer 10 ml, Agar.

Gpi—D-fructose-6-phosphate 20 mg, G6PdH, NADP,  $MgCl_2$ , MTT, PMS, 0.1 TrisHCl buffer 10 ml, Agar.

Hexdh—1-hexanol 5 ml, NAD 25 mg, Nitro blue tetrazolium 20 mg, PMS 0.5 mg, DH buffer 100 ml.

Isdh—DL-isocitric acid 20 mg, NADP,  $MgCl_2$ , MTT, PMS, 0.1 TrisHCl buffer 10 ml, Agar.

Lap—L-leucyl- $\beta$ -naphthylamide HCl 20 mg, Black K salt 50 mg, Tris maleate A 12.5 ml, Tris maleate B 6.5 ml, water 81 ml.

Mdh—Substrate solution 1.5 ml (containing L-malic acid 13.4 g, 2M  $Na_2CO_3$  49 ml, water to 100 ml, adjusted to pH 7 with  $Na_2CO_3$ ). NAD, MTT, PMS. 0.1 TrisHCl buffer 10 ml, Agar.

Mpi—D-mannose-6-phosphate 10mg, G6PdH, PGI, NADP, MTT, PMS, 0.1 TrisHCl buffer 10 ml, Agar.

Odh—(+)octopine 8 mg, NAD, MTT, PMS, 0.1 TrisHCl buffer 10 ml, Agar.

6Pgd—6-phosphogluconic acid 10mg, NADP, MTT, PMS, 0.1 TrisHCl buffer 10 ml, Agar.

Pgm— $\alpha$ -D-glucose-1-phosphate 30 mg,  $\alpha$ -D-glucose-1,6-diphosphate 0.5 mg, G6PdH, NADP, MTT, PMS,  $MgCl_2$ , 0.1 TrisHCl buffer 10 ml, Agar.

Sdh—D-sorbitol 250 mg, NAD, MTT, PMS, DH buffer 10 ml, Agar.

Sod—lightly colored bands representing this enzyme were most apparent on the darkly stained Hexdh gel.

Xdh—Hypoxanthine 10 mg, 0.05M TrisHCl pH 7.5 10 ml (boiled to dissolve Hypoxanthine then cooled to room temperature), KCl 15 mg, NAD, MTT, PMS, Agar.

Isozyme bands are named according to their mobilities compared to the most common allele in WYTH, the reference population. Methods and assumptions are those in Ayala et al. (1973).

#### Analytical methods

The program NT-SYS of Rohlf et al. (1972) was used to explore the electrophoretic and morphological relationships among the *Goniobasis* populations. For the shell morphometric study, a principal component analysis was performed on the correlation matrix of standardized means for the seven characters. The factor scores on the first 3 principal components were used as the initial configuration for multidimensional scaling. The scaling was done to maximize goodness-of-fit to the monotonic regression of the distance between populations in three-dimensional space and their true distances in seven-dimensional space. Here taxonomic distance was calculated as the square root of the average squared difference between populations across the morphological variables (Sokal, 1961). Finally, principal component analysis was reapplied to the covariance matrix of the new three-dimensional scaled distances (three factors account for 100% of the variance).

The analysis of the electrophoretic data was similar to that applied to the shell characters. Genetic distances were calculated according to Nei (1972). Then multidimensional scaling was performed to maximize goodness-of-fit to the regression of genetic distance and distance in three-dimensional space. The initial configuration of the points in the analysis of electrophoretic data was random. Three-dimensional scaling was followed by principal component analysis as described above. More complete discussion of these methods is given by Sneath & Sokal (1973).

Here we introduce a method of quantifying population divergence. The amount of divergence necessary to explain variation in the phenotypes of  $n$  populations is minimized by joining them in a Wagner or Steiner network including  $2n-3$  segments and  $n-2$  branching points or nodes (Farris, 1970). Thus if evolution has occurred parsimoniously, the Wagner network best reconstructs the evolutionary relationships among a group of populations. But a problem may arise using this method if the object is to compare divergence measured by several criteria, for small differences

in the measures to be compared may alter the order of linkage in the network. Thus we propose an alternate method of examining divergence that may, for small numbers of populations, approximate the Wagner network.

The species centroid for some group of characters is the point corresponding to the average of all character measurements over some set of conspecific populations. In the case where the number of populations,  $n$ , equals three, a Wagner network is formed by connecting the populations to their centroid. The centroid can be seen as a hypothetical population, and the minimum amount of divergence necessary to explain observed population variation can be measured as the length of the three segments radiating from the centroid. It is not necessary to designate the centroid or one of the surrounding points as the ancestral population if only the amount of divergence is of interest, and its direction is immaterial.

When  $n$  is greater than three, the centroid connected to its surrounding populations is no longer the minimum estimate of population divergence, but it remains a (successively worsening) approximation. In this study we estimate the divergence of each population  $i$  as its euclidean distance  $D$  to the species centroid:

$$D = \left( \sum_k (\bar{x} - x_i)^2 \right)^{1/2}$$

where  $x_i$  is the coordinate of the population on some axis  $x$ ,  $\bar{x}$  is the mean coordinate over  $n$  conspecific populations, and  $k$  is the number of characters or axes. We employ this technique to cases where  $n = 4$  and  $n = 6$ .

## RESULTS

### Electrophoresis

Allelic frequencies at each of the ten polymorphic loci are presented in Table 4. No variability was found at five loci, *Acph*, *Hexdh*, *Mdh*, *6Pgd*, and *Sdh*. Table 4 also shows mean heterozygosities ( $H$ ) of 15 loci for the 12 populations. Some enzyme assays, particularly that for *Xdh*, were not included until later in the study and thus have small sample sizes. Small samples may also result from reduced enzymatic activity in some populations. *Lap* activity in particular was occasionally absent from individuals in the IND and ROCK populations and was entirely absent in

the HILL population. But 12 snails collected from the HILL population in July, 1979, all showed strong *Lap* activity. They were homozygous for the common *G. proxima* allele, *Lap* 94. It thus seems possible that synthesis of this enzyme is under environmental control, and that all individuals from the HILL population may have the capacity to synthesize *Lap* 94. No "null" allele of *Lap* is believed to be segregating.

Table 5 presents values of Nei's (1972) genetic identity  $I$  and distance  $D$  for all pairs of populations, and Fig. 3 depicts these relationships graphically. Stress in the multidimensional scaling after 50 iterations was 0.015, and the correlation between taxonomic distance and three-dimensional scaled distance was 0.975. The first two factors account for 53.4% and 45.3% of the variance, respectively. The third factor (ungraphed) accounts for only 1.3% of the variance, but ROCK (Rc) is separated by a high factor III score and ROA (Ra) is distinguished by a low factor III score. Several segments of the minimum-spanning tree (cf. Sneath & Sokal, 1973) are shown connecting the major clusters. For the sake of clarity the entire tree is not shown, but since the two dimensions graphed account for nearly 99% of the variance, the tree's structure is generally obvious. Details of the two major species clusters are shown in a pair of magnified insets to Fig. 3. In the inset each population is connected to its species centroid. The length of these segments is a measure of population divergence in the two dimensions graphed.

### Shell morphometrics

The population means for the seven shell characters measured are presented in Table 1, along with their standard errors. The results of the three-dimensional scaling of these data are shown in Fig. 4. Once again the third factor accounts for a small portion of the variance (5.6%) and is ungraphed. The YAD (Y) and PINE (P) populations both had exceptionally low factor III scores and are thus more distinct from conspecific populations than Fig. 4 indicates. The two graphed factors accounted for 77.1% and 17.2% of variance, respectively. After 50 iterations, stress was 0.003 and the correlation between taxonomic distance and three-dimensional scaled distance was 0.999.

Fig. 5 shows the relationship between two measures of intraspecific divergence, genetic and shell morphometric. Divergence has been

TABLE 4. Allelic frequencies at polymorphic loci in 12 populations of *Goniobasis*.

Enzyme allele	HILL	IND	JEF	YAD	ROCK	CRIP	PINE	MEAD	SINK	ROA	WYTH	HOLS
Aat 100	1.00	1.00	1.00	1.00	1.00	1.00					1.00	1.00
102							1.00	1.00	1.00	1.00		
98	66	36	71	103	49	58	44	75	36	46	123	50
No.												
G6pd 100	1.00	1.00	1.00	1.00	0.84	1.00	1.00	1.00	1.00	1.00	1.00	1.00
105					0.16							
No.	36	42	71	67	47	52	44	61	34	40	90	44
Gpi 100												
99							1.00	0.99	1.00	0.99	0.98	1.00
97	.02	.03			.21					0.01	0.02	
95												
102	.98	.97	1.00	1.00	0.79	1.00		0.01				
No.	65	60	64	108	63	52	44	75	43	46	122	50
Isdh 100	1.00	0.99	1.00	1.00	1.00	1.00	1.00	1.00	1.00	0.99	1.00	1.00
91		0.01								0.01		
No.	72	60	29	78	40	58	44	70	43	37	87	50
Lap 100							1.00	1.00	1.00	1.00	1.00	1.00
99												
98												
96		1.00	1.00	1.00	1.00							
94						1.00						
No.	0	6	71	46	13	58	28	75	17	41	113	54



estimated using euclidean distance to the species centroid as outlined in the methods section. All three dimensions were considered, although only the first two have been depicted in Figs. 3 and 4. Since the pair of *G. simplex* populations sampled were electro-

phoretically indistinguishable, *G. simplex* was omitted from this analysis. The Spearman rank correlation coefficient is .70, significant at the .05 level. Rank correlation is appropriate regardless of whether the segment lengths in the morphometric analysis are de-

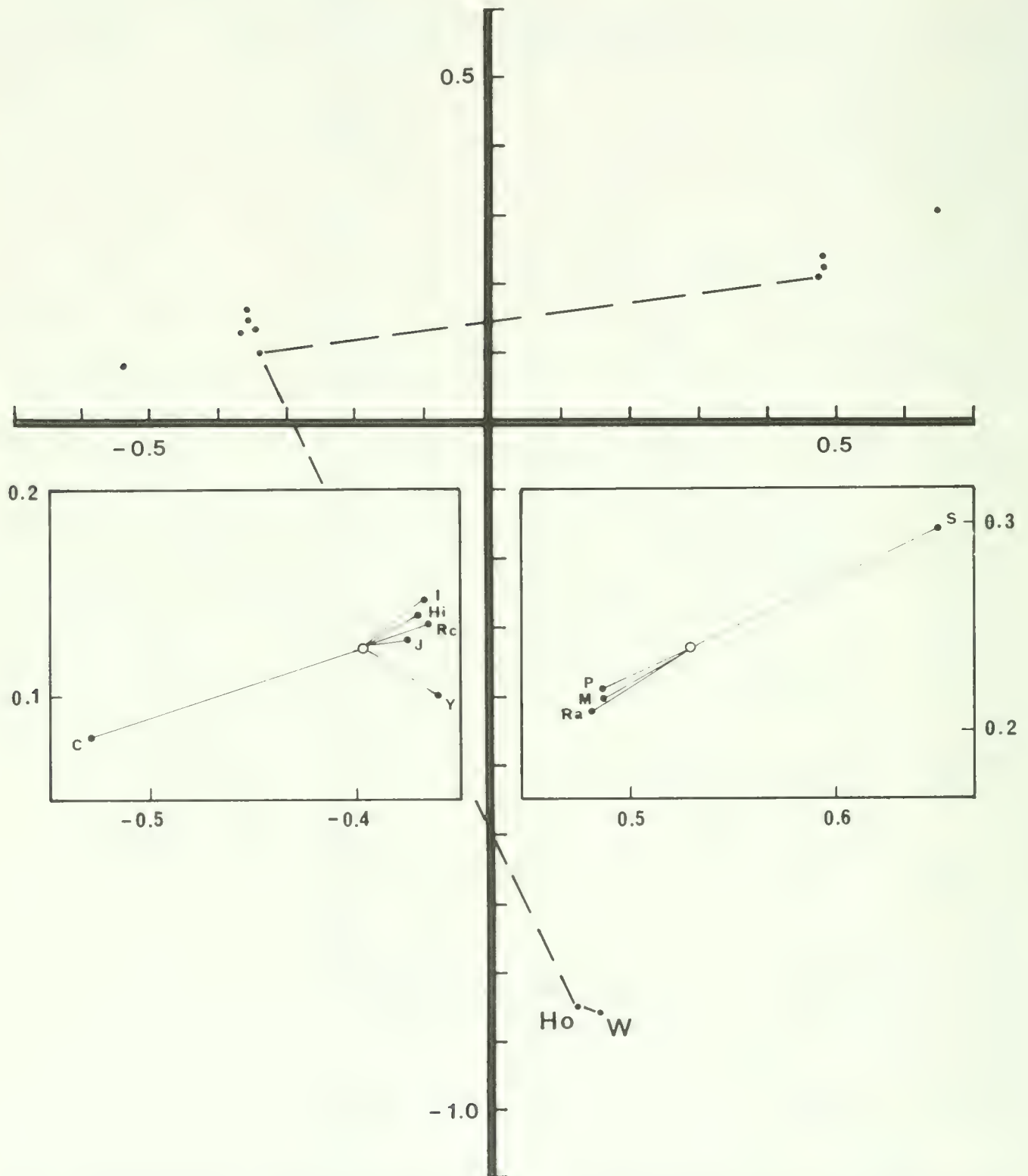

FIG. 3. Multidimensional scaling of *Goniobasis* populations based on Nei's (1972) genetic distances. The dashed lines are segments from the minimum-spanning tree. The magnified inset on the left shows details of the *Goniobasis proxima* cluster, and the inset on the right shows *G. semicarinata*. Centroids for the two common species are graphed as open circles. Population names are abbreviated as follows: C—CRIP, Hi—HILL, Ho—HOLS, I—IND, J—JEFF, M—MEAD, P—PINE, Ra—ROA, Rc—ROCK, S—SINK, W—WYTH, Y—YAD.

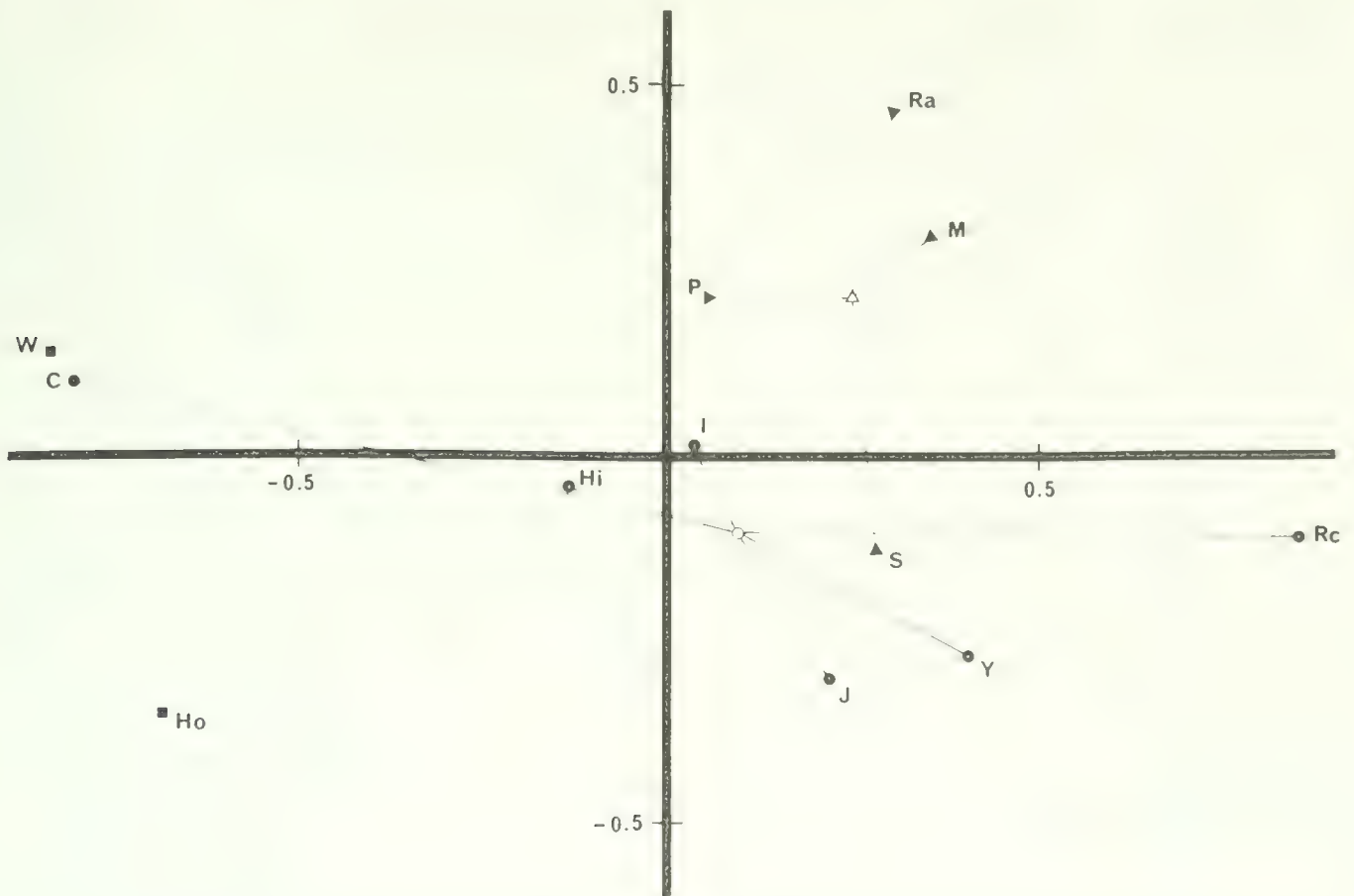

FIG. 4. Multidimensional scaling of *Goniobasis* populations based on shell morphology and Sokal's (1961) measure of taxonomic distance. Circles are *G. proxima* populations, triangles are *G. semicarinata*, and squares are *G. simplex*. Centroids are graphed as open circles. Abbreviations as in Fig. 3.

TABLE 5. Nei's (1972) genetic identities (below diagonal) and distances (above diagonal) between *Goniobasis* populations.

	HILL	IND	JEF	YAD	ROCK	CRIP	PINE	MEAD	SINK	ROA	WYTH	HOLS
HILL	—	.065	0.00	.051	.151	.144	.402	.398	.508	.402	.627	.615
IND	.937	—	.065	.033	.147	.219	.397	.392	.502	.396	.622	.610
JEF	1.00	.937	—	.050	.152	.143	.405	.401	.511	.405	.627	.616
YAD	.950	.968	.951	—	.134	.204	.326	.324	.493	.387	.609	.598
ROCK	.860	.863	.859	.875	—	.150	.485	.475	.602	.380	.627	.616
CRIP	.866	.803	.867	.816	.861	—	.510	.505	.628	.509	.627	.617
PINE	.669	.673	.667	.722	.616	.600	—	0.00	.143	.143	.627	.623
MEAD	.672	.676	.670	.723	.622	.603	1.00	—	.140	.136	.623	.620
SINK	.602	.605	.600	.611	.548	.534	.867	.869	—	.223	.761	.757
ROA	.669	.673	.667	.679	.684	.601	.866	.872	.800	—	.627	.623
WYTH	.534	.537	.534	.544	.534	.534	.534	.536	.467	.534	—	0.00
HOLS	.541	.543	.540	.550	.540	.540	.536	.538	.469	.536	1.00	—

terminated by the additive effects of numerous genes or slight allometric differences.

#### DISCUSSION

On the basis of isozyme frequencies, the three *Goniobasis* species are quite distinct.

Fig. 3 illustrates that populations of the three species form clusters easily distinguishable from one another. Within species, however, a great deal of genetic divergence has taken place. The mean Nei identity between con-specific populations,  $.89 \pm .06$  (one standard deviation), is quite similar to the value of  $.86 \pm$

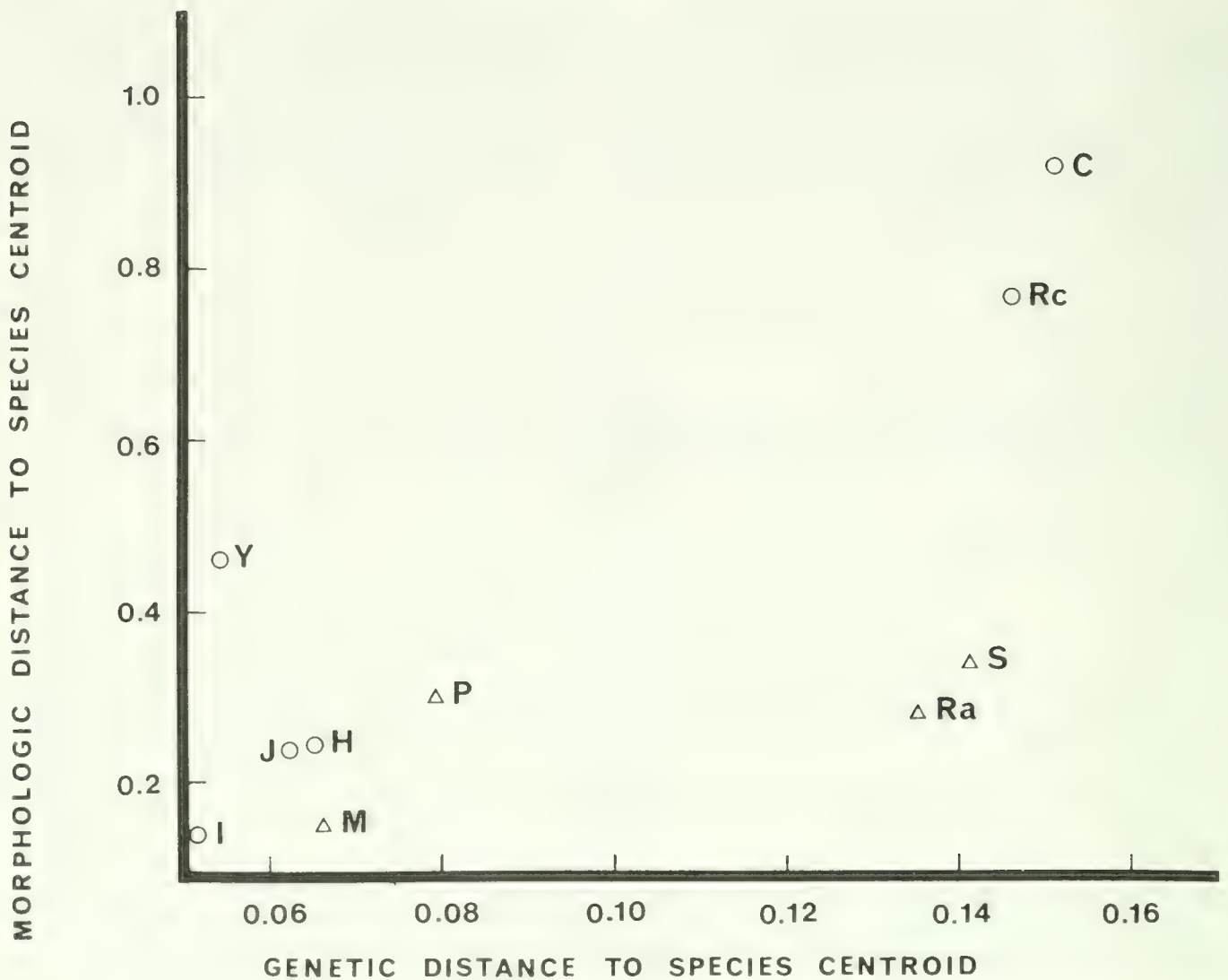

FIG. 5. Comparisons of two measures of population divergence, electrophoretic and morphometric. Symbols as in Fig. 4; abbreviations as in Fig. 3.

.09 obtained by Chambers (1977) for Florida *Goniobasis* and strikingly less than the average identities of conspecific animal populations compiled by Avise (1976), generally .95 to .99. The degree of genetic identity of conspecific *Goniobasis* populations seems more comparable to that of subspecies in other animals. The fixation of alternative alleles is also quite unusual in conspecifics. It seems probable that gene flow between populations of the same species or species-complex can be extremely low, even within a single drainage system.

A widely recognized shortcoming of electrophoresis is the problem of hidden variation. Recently workers have varied gel pH and concentration and employed techniques such as heat denaturation and isoelectric focusing to show that the amount of genetic variation visible using more conventional electrophoretic techniques is a small fraction of the actual amount (Coyne, 1976; Singh et al., 1976;

Johnson, 1977). It is probable, therefore, that the values we report here for genetic similarity are systematically overestimated. However, the genetic similarities compiled by Avise (1976) were generally based on electrophoretic techniques comparable to ours, so the comparison is valid.

The mean heterozygosity (H) across the 12 populations was 0.0113, a very low value compared to those of other animal populations (Selander, 1976). Although many factors can influence the amount of genetic variation within populations, one likely explanation for this extremely low heterozygosity is that many of these *Goniobasis* populations have experienced a severe "bottleneck effect" (Nei et al., 1975). If populations are founded by small numbers of individuals and immigration remains low, the genetic variability of the founding population tends to decrease. There is a high probability that alleles will be lost from small populations through chance alone. Vari-



ability increases by new mutations with time and population growth, but a large number of generations may be required to regain the level of heterozygosity of the founding population. So even though the *Goniobasis* populations studied are all currently large, the low genetic variability observed in them may result from a long history of "bottleneck effects." Another possibility is that the results are due to natural selection imposed by particular environmental conditions.

The three species are also fairly distinct on the basis of the seven shell characters considered together (Fig. 4). With the exceptions of SINK (S) and CRIP (C) species occupy separate regions of the figure. Shells from the SINK (S) population of *G. semicarinata* can be distinguished easily from *G. proxima* shells by their light brown exteriors, whitish apertures and the absence of carination on their whorls. *G. proxima* shells are dark brown to black, with a dark, often banded aperture and carinate whorls. Fig. 2 illustrates some of these distinctions. However, the CRIP (C) population of *G. proxima* is quite similar to *G. simplex* both in the shell characters measured (Fig. 4) and in color and lack of ornamentation (Fig. 2). The CRIP population was in fact confused with *G. simplex* in initial field surveys.

A likely explanation for the convergence in shell characters of the CRIP population is that CRIP is the only *G. proxima* population collected from a limestone-draining stream. Fig. 1 shows that throughout the study area, *G. proxima* inhabits only gneiss/schist areas and other species are found only in limestone areas. Table 6 shows that alkalinities were high where *G. simplex* and *G. semicarinata* were collected and low where *G. proxima* was

collected. The single exception is CRIP, a *G. proxima* population collected in moderately alkaline water from a creek on the border of the limestone area. With more calcium available, the CRIP population has developed a larger, heavier shell than the typical *G. proxima*, and resembles *G. simplex*.

The CRIP population has diverged further from conspecific populations in both shell shape and isozyme frequencies than any other population surveyed. Despite the problem that the shells of different species may converge, Fig. 5 shows that divergence in shell morphology is correlated to genetic divergence in conspecific populations. This suggests that shell morphology has enough genetic component to be useful as a measure of evolutionary relationships among conspecifics. The correspondence between morphological and allozyme data has been examined in numerous studies on other groups of animals (Schell et al., 1978). In general, little evidence of relationship has been found. However, no study to date has examined within-species divergence and employed this centroid method.

Notice also in Fig. 5 that the data seem bimodally distributed on the electrophoretic axis, with a group of four "outliers." These four populations, CRIP (C), ROA (Ra), ROCK (Rc), and SINK (S), are fixed or nearly fixed at two of ten polymorphic loci for alleles not present in other conspecific populations. Without a much larger sample of population and a much better understanding of mating systems in these snails it is impossible to know whether the four distinctive populations are different species, subspecies, or geographical variants. Patton & Yang (1977), in discussing similar levels of electrophoretic dissimilarity in a species of pocket gopher, noted that divergence in structural gene loci does not necessarily imply reproductive isolation. But since the electrophoretic differences are substantial, the populations will be provisionally referred to as races. Race A includes HILL, IND, JEF, and YAD in *Goniobasis proxima*. CRIP is race B of *G. proxima*, and ROCK is race C. In *Goniobasis semicarinata*, PINE and MEAD are race A, SINK is race B, and ROA is race C.

In this limited sample of *Goniobasis* populations there seems to be little evidence that geographic distance between populations influences divergence. Two of the populations from outside the upper New River can be considered distinct races, and two are quite

TABLE 6. Methyl orange alkalinity at 12 *Goniobasis* stations (phenolphthalein alkalinity in parenthesis).

Station	Alkalinity (ppm)
HILL	11
IND	14
JEF	8
YAD	10
ROCK	6
CRIP	36
PINE	84 (10)
MEAD	79
SINK	87
ROA	92
WYTH	80
HOLS	54

similar to populations found in the New River drainage. Within the New River, the pair of *G. proxima* populations separated by the greatest distance, HILL and JEF, are nearly indistinguishable. The pair of *G. proxima* populations geographically closest, IND and CRIP, represent different races. Perhaps the correlation between geographic distance and genetic divergence would be evident on a smaller geographic scale.

In summary, it has been demonstrated that there is great variability in the amount of divergence between conspecific *Goniobasis* populations judged by either electrophoretic or morphometric criteria. The observed fixation of alternative alleles and the low heterozygosities are both consistent with what one might expect if interpopulation gene flow is very low, even between populations isolated only by short distances through water. However, occasionally populations of *Goniobasis* isolated by great distances remain quite similar, while those in close proximity diverge greatly. In one case an environmental variable, the limestone and dolomite in a drainage, has been implicated in morphometric divergence. Doubtless restricted gene flow and selection both play roles in promoting radiation and eventual speciation in pleurocerids.

A rigorous investigation into the influence of the various agents of pleurocerid evolution will require a large sample of populations, more detailed knowledge of their environments, and a more thorough familiarity with their biology. The anatomy and cytology of *Goniobasis* are virtually unknown. Our implicit assumptions that each population of *Goniobasis* within a single creek is randomly breeding, and that each population experiences uniform environmental pressures should be tested. Work on *Goniobasis* currently in progress addresses many of these problems. From a thorough understanding of divergence in this genus of snails inhabiting a restricted geographic area, insight may be gained regarding the process of evolution in isolated populations generally.

#### ACKNOWLEDGEMENTS

Special appreciation is due to Shary Dillon, who selflessly volunteered to rise at 5:00 a.m., grind dead snails, and wash the dirty dishes afterward. Appreciation is also expressed to Larry Hornick and Robert Dillon, Sr., for their help with the field work. The Uni-

versity of Pennsylvania Biology Department provided some of the computer time and other research support. Dr. T. Uzzell furnished the program to calculate Nei statistics. All electrophoretic analyses were performed in the laboratory of molecular genetics of the Department of Malacology, ANSP. Figs. 3–5 were prepared by Caryl Hesterman. This study was completed while the senior author held a National Science Foundation predoctoral fellowship. We thank Professor A. J. Cain and Dr. S. M. Chambers for reading and criticizing the paper.

#### LITERATURE CITED

- AMERICAN PUBLIC HEALTH ASSOCIATION, American Water Works Association, and Water Pollution Control Federation, 1976, *Standard methods for the examination of water and wastewater*, ed. 14. Washington, 1193 p.
- AVISE, J. C., 1976, Genetic differentiation during speciation. In: AYALA, F. J. (ed.), *Molecular evolution*. Sinauer, Sunderland, Mass., p. 106–122.
- AYALA, F. J., HEDGECOCK, D., ZUMWALT, G. S. & VALENTINE, J. W., 1973, Genetic variation of *Tridacna maxima*, an ecological analog of some unsuccessful evolutionary lineages. *Evolution*, 27: 177–191.
- AYALA, F. J., TRACEY, M. L., HEDGECOCK, D. & RICHMOND, R. C., 1974, Genetic differentiation during the speciation process in *Drosophila*. *Evolution*, 28: 576–592.
- BUSH, G. L., 1975, Modes of animal speciation. *Annual Review of Ecology and Systematics*, 6: 339–364.
- BUSH, G. L. & HUETTEL, R. N., 1972, *Starch gel electrophoresis of Tephritid proteins. A manual of techniques*. International Biological Programme working group on fruit flies, population genetics, project phase I, 56 p.
- CHAMBERS, S. M., 1977, *Genetic divergence during speciation in freshwater snails of the genus Goniobasis*. Ph.D. dissertation, University of Florida, 59 p.
- CHAMBERS, S. M., 1978, An electrophoretically detected sibling species of "*Goniobasis floridensis*" (Mesogastropoda: Pleuroceridae). *Malacologia*, 17: 157–162.
- CHAMBERS, S. M., 1980, Genetic divergence between populations of *Goniobasis* occupying different drainage systems. *Malacologia*, 20: 63–81.
- COYNE, J. A., 1976, Lack of genic similarity between two sibling species of *Drosophila* as revealed by varied techniques. *Genetics*, 84: 609–629.
- CRUTCHFIELD, P. J., 1966, Positive rheotaxis in *Goniobasis proxima*. *Nautilus*, 79: 80–86.
- DAVIS, G. M., 1969, A taxonomic study of some species of *Semisulcospira* in Japan (Mesogastropoda: Pleuroceridae). *Malacologia*, 7: 211–294.

- DAVIS, G. M., 1979, The origin and evolution of the gastropod family Pomatiopsidae, with emphasis on the Mekong River Triculinae. *Monograph of the Academy of Natural Sciences of Philadelphia*, no. 20: i-viii, 1-120.
- DAZO, B. C., 1965, The morphology and natural history of *Pleurocera acuta* and *Goniobasis livescens* (Gastropoda: Cerithiacea: Pleuroceridae). *Malacologia*, 3: 1-80.
- DILLON, R. T., Jr., 1977, *Factors in the distributional ecology of upper New River mollusks (Virginia/North Carolina)*. Undergraduate honors thesis, Virginia Polytechnic Institute and State University, 61 p.
- DUSSART, G. B. J., 1976, The ecology of freshwater molluscs in northwest England in relation to water chemistry. *Journal of Molluscan Studies*, 42: 181-193.
- FARRIS, J. S., 1970, Methods for computing Wagner trees. *Systematic Zoology*, 19: 83-92.
- FOIN, T. C., 1971, The distribution pattern of the freshwater prosobranch gastropod *Oxytrema proxima* (Say). *Journal of the Elisha Mitchell Science Society*, 87: 1-10.
- FOIN, T. C., Jr. & STIVEN, A. E., 1970, The relationship of environment size and population parameters in *Oxytrema proxima* (Say) (Gastropoda: Pleuroceridae). *Oecologia*, 5: 74-84.
- FUTUYMA, D. J., 1979, *Evolutionary biology*. Sinauer, Sunderland, Mass., 565 p.
- GOODRICH, C., 1940, The Pleuroceridae of the Ohio River system. *Occasional Papers of the Museum of Zoology, University of Michigan*, no. 417, 21 p.
- GOODRICH, C., 1941, The Pleuroceridae of the small streams of the Alabama River system. *Occasional Papers of the Museum of Zoology, University of Michigan*, no. 427, 10 p.
- GOODRICH, C., 1942, The Pleuroceridae of the Atlantic coastal plain. *Occasional Papers of the Museum of Zoology, University of Michigan*, No. 456, 6 p.
- GOODRICH, C., 1944, The Pleuroceridae of the Coosa River Basin. *Nautilus*, 58: 40-48.
- GOULD, S. J. & WOODRUFF, D. S., 1978, Natural history of *Cerion*. VIII, Little Bahama Bank—a revision based on genetics, morphometrics and geographic distribution. *Bulletin of the Museum of Comparative Zoology*, 148: 371-415.
- JOHNSON, G. B., 1977, Assessing electrophoretic similarity. *Annual Review of Ecology and Systematics*, 8: 309-328.
- KRIEGER, K. A. & BURBANCK, W. D., 1976, Distribution and dispersal mechanisms of *Oxytrema* (= *Goniobasis*) *suturalis* Haldeman (Gastropoda: Pleuroceridae) in the Yellow River, Georgia, U.S.A. *American Midland Naturalist*, 95: 49-63.
- MCKILLOP, W. B. & HARRISON, A. D., 1972, Distribution of aquatic gastropods across an interface between the Canadian shield and limestone formations. *Canadian Journal of Zoology*, 50: 1433-1445.
- MURRAY, J. & CLARKE, B., 1968, Partial reproductive isolation in the genus *Partula* (Gastropoda) on Moorea. *Evolution*, 22: 684-696.
- NEI, M., 1972, Genetic distance between populations. *American Naturalist*, 106: 283-292.
- NEI, M., MARUYAMA, T. & CHAKRABORTY, R., 1975, The bottleneck effect and genetic variability in populations. *Evolution*, 29: 1-10.
- PATTON, J. L. & YANG, S. Y., 1977, Genetic variation in *Thomomys bottae* pocket gophers: macrogeographic patterns. *Evolution*, 31: 697-720.
- ROHLF, F., KISHPAUGH, J. & KIRK, D., 1972, *NTSYS: Numerical taxonomy system of multivariate statistical programs*. Technical Report, State University of New York, Stony Brook, NY.
- ROSS, R. D., 1969, Drainage evolution and fish distribution problems in the southern Appalachians of Virginia. In: HOLT, P. C. (ed.), *The distributional history of the biota of the southern Appalachians*, Vol. I. Virginia Polytechnic Institute and State University Research Division Monograph I, p. 277-292.
- SCHELL, G. D., BEST, T. L. & KENNEDY, M. L., 1978, Interspecific morphologic variation in kangaroo rats (*Dipodomys*): degree of concordance with genic variation. *Systematic Zoology*, 27: 34-48.
- SELANDER, R. K., 1976, Genic variation in natural populations. In: AYALA, F. J. (ed.), *Molecular evolution*, Sinauer, Sunderland, Mass., p. 21-45.
- SEPKOSKI, J. M. & REX, M. A., 1974, Distribution of freshwater mussels: coastal rivers as biogeographic islands. *Systematic Zoology*, 23: 165-188.
- SHAW, C. R. & PRASAD, R., 1970, Starch gel electrophoresis of enzymes—a compilation of recipes. *Biochemical Genetics*, 4: 297-320.
- SHOUP, C. S., 1943, Distribution of freshwater gastropods in relation to total alkalinity of streams. *Nautilus*, 56: 130-134.
- SINGH, R. S., LEWONTIN, R. C. & FELTON, A. A., 1976, Genetic heterogeneity within electrophoretic "alleles" of xanthine dehydrogenase in *Drosophila pseudoobscura*. *Genetics*, 84: 609-629.
- SNEATH, P. H. A. & SOKAL, R. R., 1973, *Numerical taxonomy*. Freeman, San Francisco, 573 p.
- SOKAL, R. R., 1961, Distance as a measure of taxonomic similarity. *Systematic Zoology*, 10: 70-79.
- TRYON, G. W., Jr., 1873, *Land and freshwater shells of North America. Part IV. Strepomatidae*. Smithsonian Miscellaneous Collections, no. 253: i-iv, 1-435.
- WHITE, M. J. D., 1978, *Modes of speciation*. Freeman, San Francisco, 455 p.

## APPENDIX

The following are locality data for the 12 *Goniobasis* populations studied. "Quad" refers to United States Geological Survey topographic maps, 7.5

minute series. Map coordinates are approximate. The species of *Goniobasis* collected at each site is followed by the catalogue number of voucher specimens deposited in the Academy of Natural Sciences of Philadelphia (ANSP).

CRIP—*G. proxima*, ANSP 349362. Cripple Creek at Va. 749 bridge, 8 km E of Cedar Springs, Wythe County, VA. Cedar Springs Quad. 36°55'N; 81°19'W.

HILL—*G. proxima*, ANSP 349363. Tiny creek at U.S. 58 bridge, near junction with Va. 820. 4 km E of Hillsville, Carroll Co., VA. Hillsville Quad. 36°46'N; 80°44'W.

HOLS—*G. simplex*, ANSP 349364. Dry Run at Va. 617 bridge, 1.6 km NW of Groseclose, Smythe Co., VA. Rural Retreat Quad. 36°56'N; 81°24'W.

IND—*G. proxima*, ANSP 349365. Brush Creek at crossroads of U.S. 21 and Va. 701, 4.8 km S of Independence, Grayson, Co., VA. Sparta West Quad. 36°38'N; 81°11'W.

JEF—*G. proxima*, ANSP 349366. Cranberry Creek by U.S. 221 at Co. 1145 bridge, 11 km N of Deep Gap, Ashe Co., NC. Todd Quad. 36°14'N; 81°32'W.

MEAD—*G. semicarinata*, ANSP 349367. Meadow Creek at Va. 787 bridge, 3.2 km N of Grayson-

town, Montgomery Co., VA. Radford South Quad. 37°05'N; 80°33'W.

PINE—*G. semicarinata*, ANSP 349368. Little Pine Run at Va. 100 bridge, near Pine Run Church. Pulaski Co., VA. Fosters Falls Quad. 37°01'N; 80°33'W.

ROA—*G. semicarinata*, ANSP 349369. Mill Creek, .8 km upstream from mouth, .3 km of Bennetts Mill, Montgomery Co., VA. McDonalds Mill Quad. 37°15'N; 80°19'W.

ROCK—*G. proxima*, ANSP 349370. Tiny branch of Rock Castle Creek at Va. 8 bridge, 4 km NW of Woolwine, Patrick Co., VA. Woolwine Quad. 36°39'N; 80°22'W.

SINK—*G. semicarinata*, ANSP 349371. Sinking Creek at Newport Park, Newport, Giles Co., VA. Newport Quad. 37°20'N; 80°29'W.

WYTH—*G. simplex*, ANSP 349372. Mill Creek downstream from confluence with Huddle Branch by Va. 680, 4.7 km N of Rural Retreat, Wythe Co., VA. Rural Retreat Quad. 36°54'N; 81°18'W.

YAD—*G. proxima*, ANSP 349373. Small creek at Lewis Fork Road Bridge (at crossroads of Co. 1155 and 1156), 3.2 km W of Mount Pleasant, Wilkes Co., NC. Purlear Quad. 36°04'N; 81°29'W.

DEVELOPMENT AND FEEDING OF LARVAE OF THE NUDIBRANCH  
GASTROPODS *HERMISSENDA CRASSICORNIS* AND  
*AEOLIDIA PAPILLOSA*

Leslie G. Williams

*Pacific Marine Station, Dillon Beach, California 94929, U.S.A.*<sup>1</sup>

ABSTRACT

Preliminary observations of developmental sequence of two aeolid nudibranchs, *Hermis-senda crassicornis* and *Aeolidia papillosa*, indicated that planktotrophic larvae of both species hatch from their egg mass with yolk reserves in the stomach and digestive diverticulum. Comparison of development and feeding of these two species was undertaken in order to evaluate the relative importance of yolk reserves and of phytoplankton to larval nutrition and life history.

Early embryology and larval development to hatching is similar in the two species. Cleavage is characterized by the appearance of an asynchronous three cell stage and, otherwise, follows the typical spiral pattern of the Mollusca and results in the formation of a stereoblastula. Gastrulation is characterized by the formation of a sagittal cleft. Subsequent maturation through the transitory trochophore and early veliger stages leads to hatching of free-swimming veliger larvae seven and eight days (14°C) after fertilization for *Hermis-senda crassicornis* and *Aeolidia papillosa*, respectively.

The veliger larvae of both species are dextrally organized and show planktotrophic morphology. Larval shells of both species are coiled and characterized by six to seven oblique striations on the whorl and inner lip next to the aperture. However, mean shell length of *Aeolidia papillosa* larvae is significantly greater than that of *Hermis-senda crassicornis* larvae (116 and 102  $\mu\text{m}$ , respectively).

At hatching each species is polytypic with respect to relative yolk reserves and feeding ability. In each case, shell length distributions of yolk-laden and yolk-free larvae were normal with mean shell length of yolk-free larvae being significantly greater than that of their yolk-laden siblings. Feeding ability of recently hatched larvae of each species is determined by the presence of yolk reserves, the size of larvae, and the size of algal cell available for ingestion. With few exceptions, yolk-laden larvae did not ingest algal cells offered as food while their larger, yolk-free siblings did so easily. Mean shell length of newly hatched larvae capable of feeding increased with increased size of algal cell offered as food. For instance, shell length of *A. papillosa* larvae feeding on *Chlorella* is significantly less than the shell length of larvae feeding on the larger alga *Phaeo-dactylum tricorutum*. Larval feeding is governed by two main factors: 1) physical limitation imposed by their mechanical ability to handle large particles, and 2) selection for the largest particles they are capable of ingesting.

Larvae of *H. crassicornis* and *A. papillosa* are functionally, morphologically, and, in all likelihood, morphogenetically planktotrophic. Neither species is unusual in this regard. The presence of yolk reserves at hatching allows a portion of the larval population temporary independence of phytoplankton and, perhaps, increased dispersal.

INTRODUCTION

Thompson (1967) employed morphological as well as embryological criteria in his definition of planktotrophic, lecithotrophic, and direct sequences of development among opisthobranchs. Planktotrophic larvae develop rapidly from numerous, small (yolk-poor) eggs, and lack certain adult or advanced larval characteristics necessary for successful

metamorphosis at hatching. Lecithotrophic larvae develop slowly from few, large (yolk-laden) eggs, and emerge from the egg case endowed with somatic features that anticipate the adult mode of life and therefore render them competent to metamorphose. The morphological features, which occur in lecithotrophic larvae but not in premetamorphic planktotrophic larvae, are a rudimentary radula, an adult kidney vesicle, eyespots, and propodi-

<sup>1</sup>Present address: University of Delaware, College of Marine Studies, Lewes, Delaware 19958, U.S.A

um. Direct development is accomplished through ametamorphic embryogenesis or metamorphosis of an encapsulated veliger, and results in liberation of a juvenile (Bonar, 1978).

The major explicit assumption in Thompson's (1958, 1962, 1967) and Tardy's (1970) classification of development types is that feeding and subsequent growth are necessary prerequisites for metamorphosis of planktotrophic larvae. More recent work on planktotrophic development of *Phestilla melanobranchia* (Harris, 1975), *Doridella obscura* (Perron & Turner, 1977), and *Hermisenda crassicornis* (Harrigan & Alkon, 1978) reaffirms the obligatory feeding of this type of larvae for continued somatic growth and consequent metamorphosis to occur. By comparison, lecithotrophic larvae are initially yolk-laden and presumably capable of metamorphosis without feeding. Lecithotrophic larvae may feed facultatively if depletion of yolk reserves occurs during search for a substratum necessary to induce metamorphosis. The relationships among larval feeding, larval morphology, and metamorphosis are clearly important in assessing the selective pressures which have led to ecologically distinct life history patterns.

Preliminary observations of developmental sequence of two aeolid nudibranchs, *Hermisenda crassicornis* (Eschscholtz) and *Aeolidia papillosa* (L.), were interesting because each species produced planktotrophic larvae with yolk reserves in the stomach or digestive diverticulum, a phenomenon more characteristic of lecithotrophic than planktotrophic larvae. Comparison of development and feeding of these two species was undertaken to assess the importance of yolk reserves to nutrition and life history of planktotrophic larvae. The first objective of the study was to document the planktotrophic characteristics of the larvae using embryological (developmental sequence and rate) as well as morphological (eyespots, radula, propodium) criteria. The second objective was to assess the importance of yolk reserves through direct observation of functional morphology of feeding behavior and through several feeding experiments.

## MATERIALS AND METHODS

### Collection and culture of egg masses

Adult *Hermisenda crassicornis* was collected from beds of *Zostera marina* Linnaeus

located on Lawson's Flat, Tomales Bay, California. Adult *Aeolidia papillosa* was collected from floating docks at Mason's Marina and the north jetty in Bodega Harbor, California. Adults of both species were isolated in plastic aquaria and supplied with running seawater in the laboratory. *H. crassicornis* laid egg masses in the laboratory during the entire year of study (August, 1970 to July, 1971) while *A. papillosa* egg masses were laid only from May through September 1971, the period of availability of the adult animals.

Development was followed for 50 *H. crassicornis* and for 25 *A. papillosa* egg masses spawned and cultured in the laboratory. The extreme abundance of *H. crassicornis* and its spawn on Lawson's Flat allowed additional observations on approximately 120 egg masses collected in the field.

Egg masses deposited on the sides of aquaria were removed and cultured in 500 ml flasks at 14.0°C. The egg masses and hatched veligers were washed daily on a 45  $\mu\text{m}$  mesh screen and returned to clean culture flasks containing filtered seawater. Hatched larvae were fed mixed suspensions from algal cultures of *Pavlova lutheri* Droop, *Isochrysis galbana* Parke, *Dunaliella tertiolecta* Butcher, *Chlorella* clone 580, and *Phaeodactylum tricornutum* Bohlin. Algae were cultured in Guillard & Ryther's (1962) f/2 concentration of nutrients at 17°C.

### Developmental sequence

Observations and photographs of developmental sequence and of encapsulated larval stages were made on living specimens, with a compound microscope using phase contrast and bright field optics. Egg capsules and embryos were prepared for observation by teasing out a portion of an egg mass and placing it under a cover slip with a drop of sterile seawater. After examination this preparation was either discarded or placed on moist toweling to prevent dessication and returned to the incubator for later retrieval and re-examination.

### Larval feeding

Functional morphology. Upon hatching, veliger larvae were given suspensions of *Pavlova lutheri* (4.1  $\mu\text{m}$  diameter), *Isochrysis galbana* (4.2  $\mu\text{m}$ ), *Dunaliella tertiolecta* (9.4  $\mu\text{m}$ ), *Chlorella* 580 (4.4  $\mu\text{m}$ ), and *Phaeodactylum tricornutum* (12.5 to 17.8  $\mu\text{m}$  along the longest axis) to determine which of the five

algal species they would eat. Photographic observations of manipulation of algal particles by the cephalopodal and alimentary cilia were made with a 35 mm single lens reflex camera mounted on a Labolux Leitz equipped with carbon-arc illumination and a trinocular head.

Feeding experiments. An experiment was performed to determine the residence time of algal cells in the stomach of *Hermisenda crassicornis* larvae. Recently hatched larvae were fed a combined suspension of *P. lutheri*, *I. galbana*, and *D. tertiolecta*. After 48 hours the larvae were transferred from the algal suspension to clean, filtered seawater. Larvae were then sampled ( $n = 100$ ) seven times during the 53 hours following their removal from the algal suspension, and examined for the presence of algal cells or pigmentation in the left digestive diverticulum.

Preliminary observations of shell length suggested that *H. crassicornis* were size dimorphic with respect to the presence or absence of yolk reserves at hatching. Therefore, a series of observations of *H. crassicornis* larvae hatched from the same egg mass was made in order to test the following null hypothesis: 1) there is no difference in size between yolk-laden and yolk-free larvae at hatching, 2) there is no difference in size between yolk-free larvae and larvae able to feed, 3) there is no difference in size between yolk-laden and nonfeeding larvae, and 4) there is no difference in size between larvae feeding on small algal cells and those feeding on large cells. At the beginning of the experiment 100 recently hatched larvae were examined for the presence of yolk reserves in the left digestive diverticulum. The right digestive diverticulum was not examined since it is not used in digestion of algal cells by nudibranch larvae observed by Thompson (1959) as well as by those used in this study. Independent samples were taken and shell length measurements made by ocular micrometer were then recorded for 20 larvae with and 20 larvae without yolk reserves in the diverticulum. Additional independent and random samples were taken to measure shell length ( $n = 100$ ), shell width ( $n = 27$ ), and shell height ( $n = 39$ ) without consideration to the presence or absence of yolk reserves. Approximately 1000 larvae were then added to each of two flasks containing 500 ml of sterile, filtered seawater containing  $f/2$  concentration of nutrients. Salinity in each flask was 33.0‰. A suspension of *D. tertiolecta* was added to one of the flasks while a suspension of *Chlorella* 580 was added to the other. The flasks were then

placed in an incubator at  $14.0 \pm 0.5^\circ\text{C}$  for 72 hr. Continuous illumination was provided during the experiment with a 40 watt daylight type fluorescent lamp. At the termination of the experiment 100 larvae from each flask were examined for the presence of algae in the left diverticulum. Independent samples of larvae were taken from each flask and shell length measured for 20 larvae with and 20 larvae without algae in the left diverticulum.

There are several assumptions involved in this experimental design. The first concerns the definition of yolk-laden larvae. The criterion is the presence of yolk cells in the digestive diverticulum, though the esophagus and stomach may be free of yolk cells. The reason for this definition is that algal cells ingested by a larvae must enter the digestive diverticulum for digestion. At the end of the experimental period, larvae with algal cells in the stomach or diverticulum were considered to have been feeding. A more restrictive definition of feeding ability, and one more consistent with the definition of yolk-laden larvae, would require the presence of algal cells in the diverticulum. However, the less restrictive definition was employed when it was difficult to view the digestive diverticulum from the right side of the larvae because the stomach was filled with algal cells. Problems in interpretation of the data arise because yolk-laden and yolk-free larvae were not measured at the end, as they were at the beginning, of the experiment. Thus, there is uncertainty as to the amount of growth of larvae and the degree to which yolk reserves are metabolically diminished during the experiment. Therefore, equating yolk-laden with nonfeeding larvae, and yolk-free with feeding larvae, rests on association with the shell length distributions that characterize each group at the beginning and end of the experiment, respectively.

Frequency distributions of shell length were initially tested for normality by graphic techniques (e.g., Rankits) described by Sokal & Rohlf (1969). Since these methods indicated potentially non-normal distribution of shell length, the more quantitative Kolmogorov-Smirnov statistic was calculated to test for goodness of fit of observed distribution of shell length with the normal distribution (Sokal & Rohlf, 1969). Multiple comparisons of means and tests for significant differences among experimental groups were performed using the Student-Newman-Keuls procedure as summarized by Sokal & Rohlf (1969). The Student-Newman-Keuls procedure is an a posteriori method that permits all possible

comparisons among means, and accommodates unequal sample sizes as well.

An experiment, similar to that described for *H. crassicornis* larvae, was performed for recently hatched larvae of *Aeolidia papillosa*. The four hypotheses, assumptions, and caveats concerning experimental design described for *H. crassicornis* apply to *A. papillosa* as well. The larvae used in the experiment were newly hatched, and taken from a common egg mass. At the beginning of the experiment 100 larvae were examined for the presence of yolk reserves in the left digestive diverticulum, and independent samples of shell length measured for 50 larvae with and 50 larvae without yolk reserves. Additional independent samples were taken to measure shell length ( $n = 100$ ), shell height ( $n = 30$ ) and shell width ( $n = 30$ ). Approximately 1000 larvae were then added to each of four flasks containing 500 ml of sterile seawater and f/2 concentration of nutrients ( $S^{\circ}_{\infty} = 33.0$ ). Unialgal suspensions of *Chlorella* 580, *D. tertiolecta*, or *P. tricornutum* were added to the first three flasks. The fourth flask received a mixed suspension of *Chlorella* and *P. tricornutum*. The four flasks were then incubated at 14.0°C under continuous illumination for 72 hr. At the termination of the incubation period, 100 larvae from each flask were examined for the presence of algal cells or pigmentation in the left digestive diverticulum. Independent samples of larvae were then withdrawn from each flask and shell length recorded for 30 larvae with and 30 larvae without algal cells in the left diverticulum. Kolmogorov-Smirnov tests for goodness of fit of observed with predicted, normal, distributions of shell length were performed as outlined by Sokal & Rohlf (1969). Means of experimental groups were compared using the Student-Newman-Keuls procedure (Sokal & Rohlf, 1969).

## RESULTS

### Egg masses and gametes

Both *Hermisenda crassicornis* and *Aeolidia papillosa* have white, spirally coiled egg masses with secondarily twisted egg strings (Hurst, 1967, Type B). Egg strings consist of individual egg capsules, which are elliptical and smooth in *H. crassicornis* and are irregularly shaped and wrinkled in *A. papillosa*. Occasionally the egg capsules do

not separate during spawning, but are joined end to end by either a simple constriction in the case of *H. crassicornis* or by a twisted constriction in the case of *A. papillosa*.

The number of ova per capsule was measured for 17 egg masses deposited by *H. crassicornis*. There is a significant ( $p < 0.01$ ) difference among egg masses for the number of ova per egg capsule with a coefficient of intraclass variation of 0.535.

The ova of *H. crassicornis* and *A. papillosa* are small but significantly ( $p < 0.001$ ) different in diameter from one another. The mean diameter and standard deviation of *H. crassicornis* ova is  $64.7 \pm 1.6 \mu\text{m}$  ( $n = 29$ ) while the mean diameter of *A. papillosa* ova is  $73.7 \pm 2.2 \mu\text{m}$  ( $n = 25$ ). Length of the spermatozoa in each species is approximately 150  $\mu\text{m}$ .

### Developmental sequence

The major developmental features and time to hatching of free-swimming veliger larvae of *Hermisenda crassicornis* and *Aeolidia papillosa* are summarized in Table 1.

Separation of polar bodies occurs at the animal pole in both *H. crassicornis* and *A. papillosa*, and completion of the maturation divisions results in the formation of two polar bodies in each species (Fig. 1). Division of the first polar body occurs shortly after the first

TABLE 1. Developmental time to hatching in *Hermisenda crassicornis* and *Aeolidia papillosa* cultured in seawater at 14.0°C.

Stage	Cumulative hours	
	<i>H. crassicornis</i>	<i>A. papillosa</i>
1st polar body	1.5	2.0
2nd polar body	3.4	5.0
1st cleavage	4.9	6.0
2nd cleavage	6.1	7.5
3rd cleavage	7.0	9.5
4th cleavage	9.3	13.0
morula	12.5	25.0
blastula	23.7	31.0
early gastrula	31.0	45.0
late gastrula	51.0	51.0
trochophore	65.0	82.0
shell gland invagination	75.0	88.0
shell gland evagination	83.0	95.0
early veliger	101.0	118.0
Alimentary differentiation	135.0	160.0
hatching	166.0	195.0



cleavage in *A. papillosa* but not in *H. crassicornis*. The polar bodies remain intact through early veliger stage of development and often through hatching of the larvae.

Cleavage is similar for both *H. crassicornis* and *A. papillosa*. The first cleavage is holoblastic and equal with the cleavage plane in the polar axis. The second cleavage is asynchronous, holoblastic and equal, with the cleavage plane in the polar axis at right angles to the first cleavage plane. Asynchrony at this state is characterized by division of one of the blastomeres to form a transitory three cell stage with the second blastomere dividing approximately 10 minutes after the first (Fig. 2). When viewed from the animal pole, division of the second blastomere is character-



FIG. 1. (a) Zygote and first and second polar bodies of *Hermisenda crassicornis*. (b) Zygote and first and second polar bodies of *Aeolidia papillosa*. Arrow points to cleavage furrow of first polar body.



FIG. 2. Intermediate three cell stage during asynchronous second cleavage of *Hermisenda crassicornis*.

ized by counterclockwise displacement of the daughter blastomere into a slightly lower focal plane. Thus the second cleavage appears to be laeotropic. The third cleavage is dextrotropic, holoblastic and equal. The fourth and ensuing cleavage divisions are typical of the molluscan pattern of alternating spiral cleavage.

Cleavage in each species results in the formation of a stereoblastula. Gastrulation is distinguished by formation of a blastoporal sagittal cleft (Fig. 3). During late gastrulation, the sagittal cleft closes in a zipper-like fashion beginning near the animal pole and terminating with the closure of the definitive blastopore at the vegetal pole. Gastrulation results in a stereogastrula.

Following gastrulation, the trochophore stage is recognized by development of the prototroch (Fig. 3). In each species, appearance of the prototroch is followed rapidly by formation of two posterior anal cells and the formation of the shell gland invagination posteriolaterally on the left side (Fig. 3). The prototroch subsequently differentiates into two rudimentary velar lobes and is followed by evagination of the shell gland (Fig. 4) and by formation of the metapodium. As the shell gland spreads to circumscribe the viscera, the anal cells are displaced anterolaterally to the right side. The developing embryos are early veliger larvae at this point. The shell gland secretes the definitive larval shell and then differentiates into the mantle fold and perivisceral membrane.

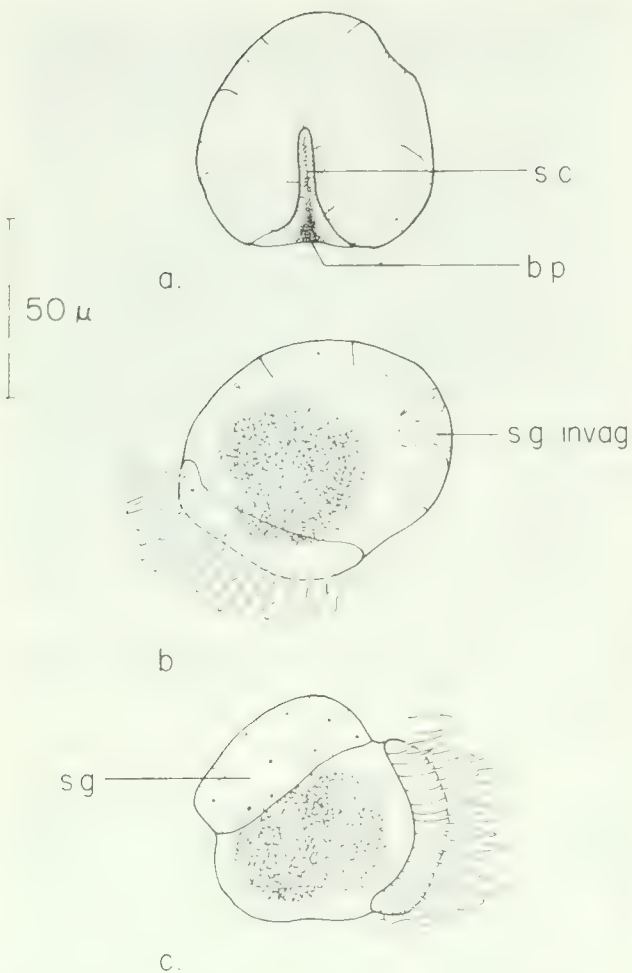

FIG. 3. *Hermissenda crassicornis*. Schematics of gastrulation (a), shell gland invagination (b), and spreading of the shell gland over the dorsum (c). Abbreviations: bp., blastopore; s.c., sagittal cleft; s.g., shell gland; s.g. invag., shell gland invagination.

Transition to a fully developed veliger larva is characterized by continued shell growth, invagination of the stomodaeum, differentiation of alimentary and larval excretory organs, formation of retractor and mantle muscles, deposition of an operculum, and appearance of bristle-like pedal cilia at the junction of the foot and operculum.

Larval shells of *H. crassicornis* and *A. papillosa* are characterized by oblique striations (Fig. 5) on the whorl and inner lip next to the aperture. These striations are present at the initial formation of the shell. During the early veliger stage, the striations extend from the ventral surface of the whorl to the right dorsolateral surface of shell.

#### Hatching

Hatching of mature veligers occurs similarly in both *Hermissenda crassicornis* and *Aeolidia papillosa*. As larvae near hatching,

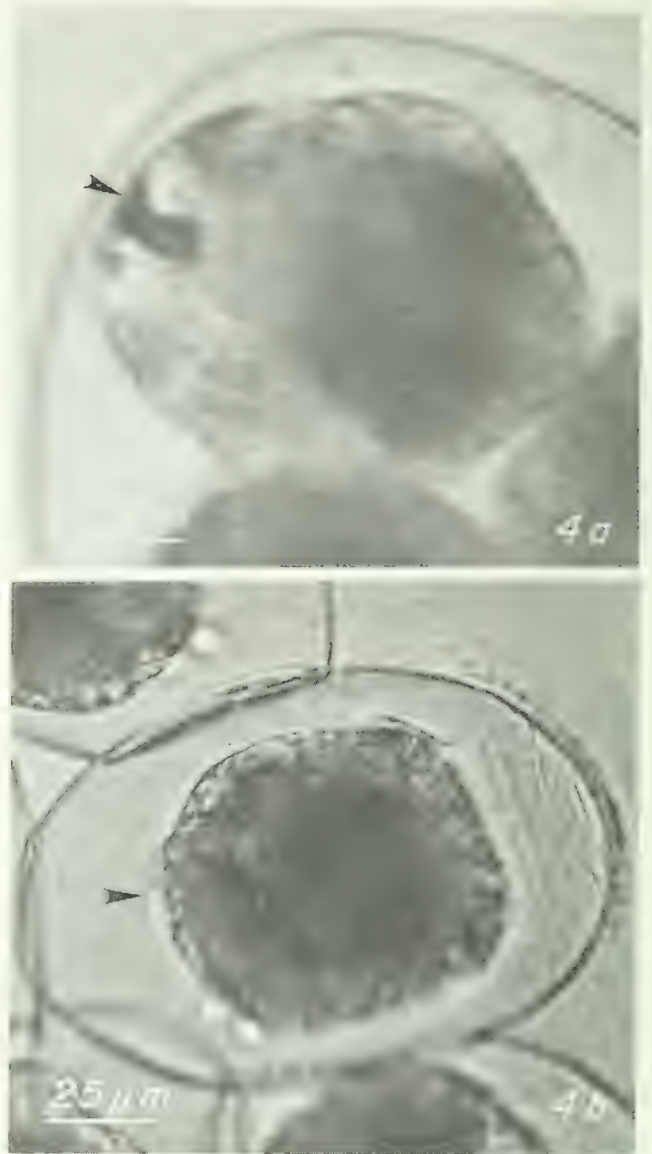

FIG. 4. *Hermissenda crassicornis* at trochophore stage. (a) Darkened area shown by arrow is the shell gland invagination. (b) Raised area shown by arrow is the shell gland evagination.

they become increasingly active, the capsule membrane becomes thin and flaccid, and in the case of *A. papillosa*, loses its wrinkled appearance. Larvae beat their velar cilia against the capsule membrane with the effective stroke forward over the velum and the direction of larval movement shell first or posteriorly. Hatching occurs by rupture of the capsule membrane along the interface between it and the shell. Larvae exit by backing through the rupture.

#### Free-swimming larvae

Larvae of *Hermissenda crassicornis* and *Aeolidia papillosa* show similar gross morphological characteristics at hatching. The hyperstrophic larval shell is the coiled, Type 1,



FIG. 5. Veliger of *Hermissenda crassicornis* prior to hatching. Arrow points to characteristic striations located on whorl of the shell.

variety described by Thompson (1961). The cephalopedal region in each species is characterized by moderately sized velar lobes, prominent sub-velar ridges, and bristle-like lateral and apical cilia located at the junction of the foot and operculum.

Internal organization is dextral with the anus opening into the right side of the mantle cavity immediately behind the larval kidney. The intestine of both species is distinguished by the presence of superficial lobes along its length. The larvae otherwise conform to Thompson's (1967) definition of planktotrophic veligers: they lack eyes, radula, propodial rudiment, and adult kidney vesicle (Fig. 6).

#### Larval feeding

**Functional morphology.** The mechanical treatment of food is similar in *Hermissenda crassicornis* and *Aeolidia papillosa*. Patterns of ciliary metachronism in *H. crassicornis* and *A. papillosa* agree with those observed by Fretter (1967) for prosobranch veligers. Velar cilia are diaplectic, and beat in a regular, metachronal fashion. If viewed from the ventral side of the veliger, the metachronal

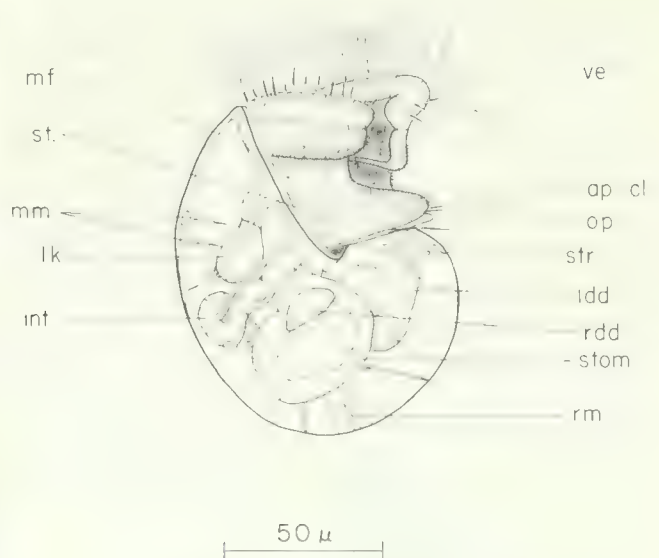

FIG. 6. Schematic of free-swimming veliger of *Hermissenda crassicornis*. Note lack of eyes, radula, and the absence of a propodium. Abbreviations: ap. cl., apical cilia; int., intestine; ldd., left digestive diverticulum; lk., larval kidney; mf., mantle fold; mm., mantle muscles; op., operculum; rdd., right digestive diverticulum; rm., retractor muscles; st., statocyst; stom., stomach; str., striations; vel., velar cilia.

waves of both velar lobes move in a clockwise direction with the effective stroke being backwards over the velum. Velar cilia demonstrate laeoplectic metachronism (Knight-Jones, 1954). The effective stroke of the post-oral cilia, on both velar lobes, is towards the mouth. Algal cells trapped by the post-oral cilia are transported to the mouth and either manipulated into the esophagus by oral cilia or are passed onto the anterior base of the foot for rejection. The effective stroke of the pedal cilia is towards the apex of the foot. Algal cells rejected by the oral cilia are conducted away from the larva via the long axis of the foot. Pedal cilia also function in rejection of algal cells displaced over the velum but not trapped by the postoral cilia. Cilia along the right side of the foot adjacent to the operculum form a strong rejection current for passage of feces and whole undigested algal cells from the anus to the apex of the foot. No apparent functional utilization of the bristle-like cilia located at the sides and apex of the foot was observed. Algal cells in the stomach are rotated against denticulate rods embedded in the stomach wall, and manipulated by cilia into the digestive diverticulum (Thompson, 1959). Cellular debris and undigested algal cells are transported along an anterior food groove to the confluence of the stomach and intestine (Fig. 7). Metachronal

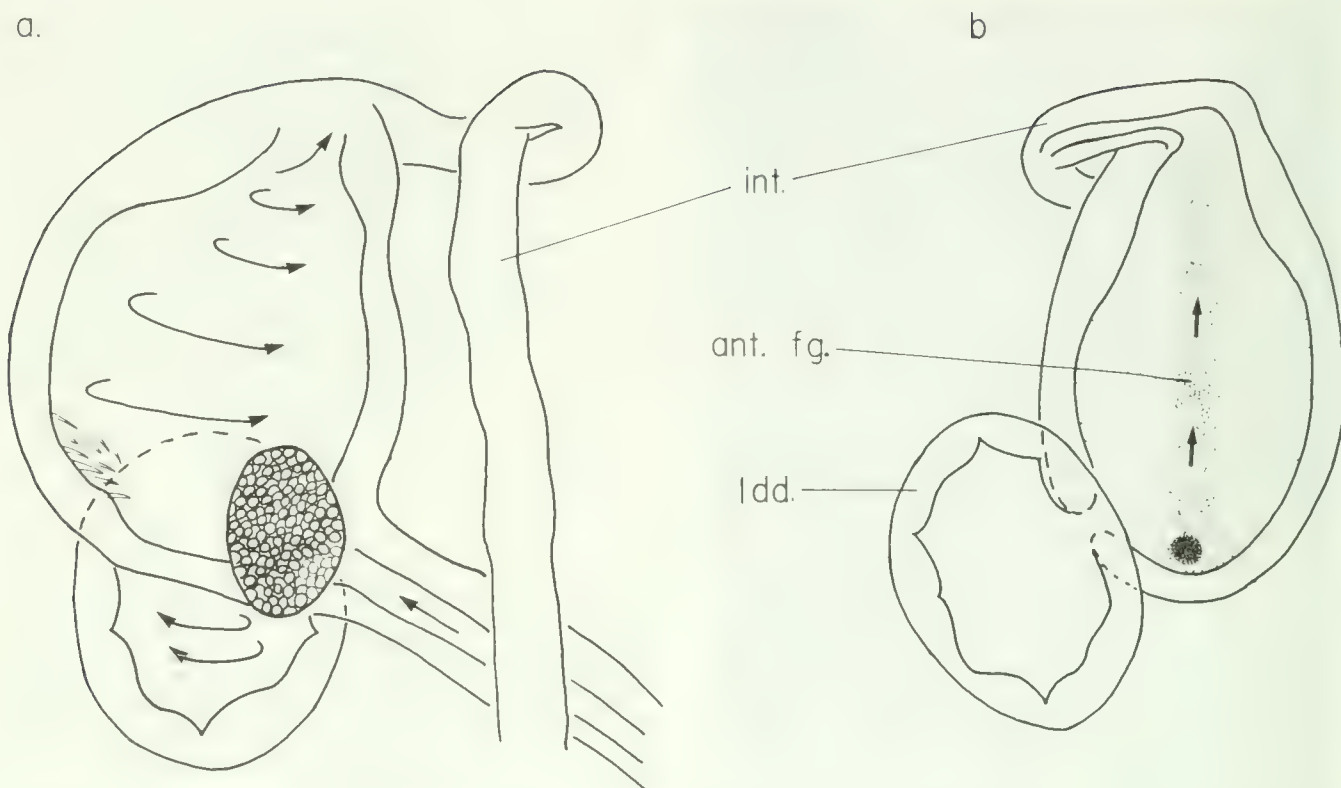

FIG. 7. Schematics of larval stomach of *Hermissenda crassicornis*. a) Profile of stomach and diverticulae viewed from right side. Note denticulate rods located in posteroventral wall of stomach. Arrows indicate direction of motion of algal cells during passage through esophagus, diverticulum, and stomach. b) Posterior view of stomach and left digestive diverticulum. Densely stippled vertical region represents anterior food groove, and arrows indicate movement of cellular debris toward confluence of stomach and intestine. Abbreviations: ant. fg., anterior food groove; int., intestine; l. d., left digestive diverticulum.

waves in the intestine move from the anus toward the stomach while the effective stroke of the cilia is towards the anus. Intestinal cilia, therefore, have an antiplectic pattern of metachronism (Knight-Jones, 1954). Feces and whole undigested algal cells are moved along the intestine, defecated through the anus and conducted away from the larva along the pedal rejection current.

Newly hatched larvae of *H. crassicornis* and *A. papillosa* readily ingested cells of *Pavlova lutheri*, *Isochrysis galbana*, *Chlorella* 580, and *Dunaliella tertiolecta*. The diatom *Phaeodactylum tricornutum* was readily ingested by the larvae of *A. papillosa* but not by those of *H. crassicornis*.

Newly hatched larvae fed voraciously when placed in a suspension of algae, often feeding until the stomach, diverticulum and esophagus become packed with algal cells. In such instances of over-feeding, larvae stopped ingesting algal cells and began defecating whole undigested cells until the esophagus was cleared and algal cells were present only in the stomach and the diverticulum. Thereafter feeding occurred sporadically with most cells passed over the velum or rejected by the

oral cilia. In cases where larvae were not initially overfed, they cleared cells from suspension until both the stomach and diverticulum contained algal cells. Feeding then occurred sporadically.

Feeding experiments. Data on the residence time of algal cells in the stomach of *H. crassicornis* larvae are presented in Fig. 8. Approximately 80% of the larvae that had initially fed on the algal suspension retained algal cells in the left diverticulum for 53 hours after removal from the suspension.

Shell measurements of randomly sampled larvae of *H. crassicornis* and *A. papillosa* used in feeding experiments show that differences between the two species are morphometric rather than morphological (Table 2). Larval shells are cup-shaped at hatching with a ratio of shell length:height:width of 1.28:1.04:1.00 for *H. crassicornis* and 1.36:1.01:1.00 for *A. papillosa*. Frequency distributions of shell length at hatching appear bimodal (Fig. 9). However, Kolmogorov-Smirnov tests of deviation of observed distribution from normality ( $d_{\max}$ , Table 2) were not significant for either *Hermissenda crassicornis* ( $0.1 < p < 0.2$ ) or *Aeolidia papillosa* ( $p >$

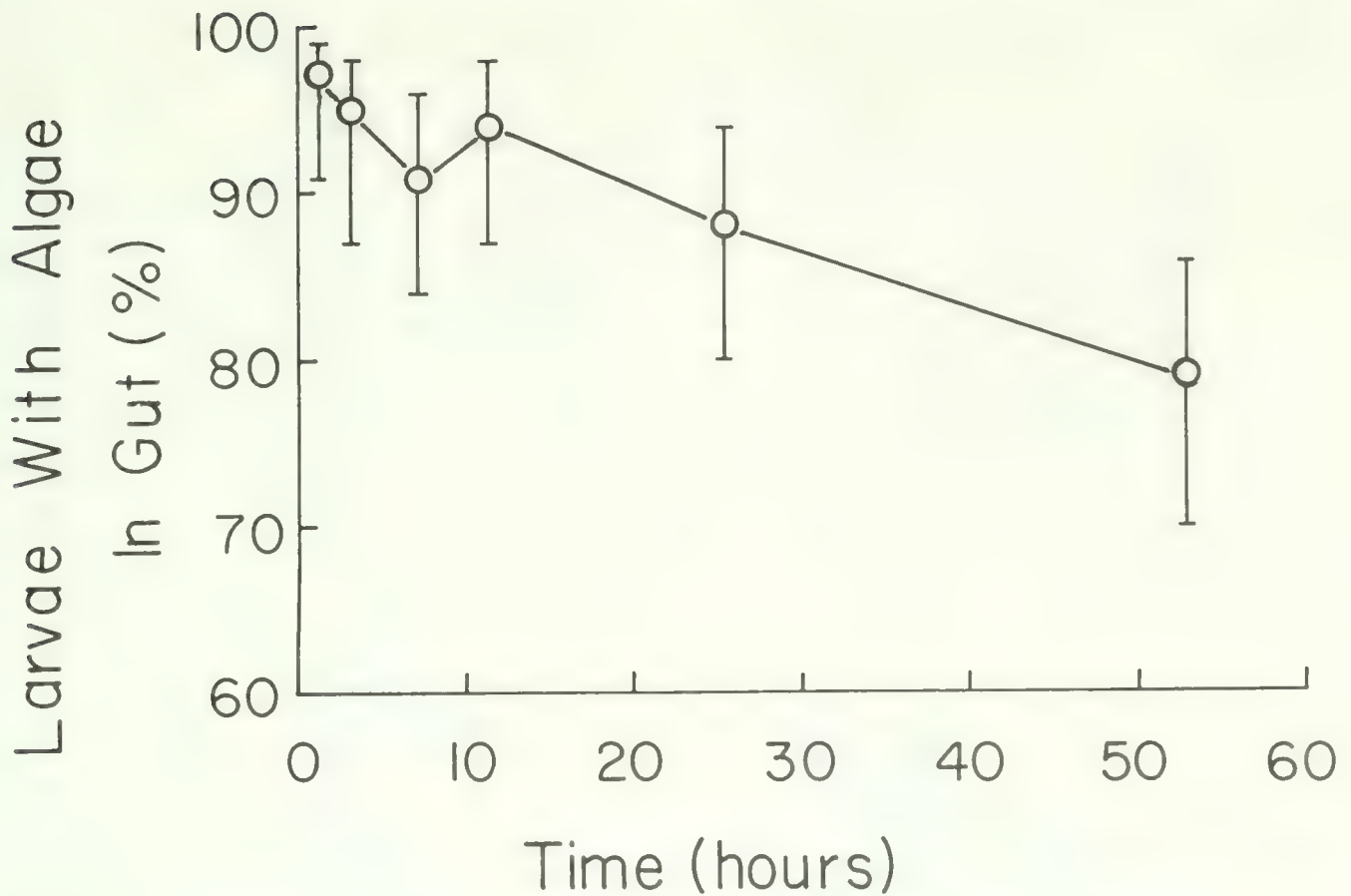

FIG. 8. Number of larvae of *Hermisenda crassicornis* with algal cells in stomach or left digestive diverticulum plotted against number of hours after their removal from a suspension of *Pavlova lutheri*, *Isochrysis galbana* and *Dunaliella tertiolecta*.

TABLE 2. Means and standard deviations of shell length, shell width and shell height of newly hatched larvae of *Hermisenda crassicornis* and *Aeolidia papillosa*. The remaining columns summarize departure from normality (Kolmogorov-Smirnov statistic,  $d_{\max}$ ), skewness ( $g_1$ ), and kurtosis ( $g_2$ ).

		N	$\bar{X}(\mu\text{m}) \pm$	S	$d_{\max}$	$g_1$	$g_2$
<i>Hermisenda crassicornis</i>	Length	100	102.1	10.03	0.110	+0.251	-0.412
	Height	27	83.1	8.77	—	—	—
	Width	39	79.7	6.17	—	—	—
<i>Aeolidia papillosa</i>	Length	100	116.0	10.04	0.100	-0.563*	-0.381
	Height	30	85.8	8.27	—	—	—
	Width	30	85.1	7.42	—	—	—

\*Significant at the 0.05 probability level.

0.2). Distribution of shell length for *A. papillosa* was significantly skewed to the left ( $p < 0.05$ , Table 2). Mean shell length and standard deviation at hatching is  $102.1 \pm 10.03 \mu\text{m}$  ( $n = 100$ ) for *H. crassicornis* and  $116.0 \pm 10.04 \mu\text{m}$  ( $n = 100$ ) for *A. papillosa*. Also 40–60% of newly hatched *H. crassicornis* and 80–90% of newly hatched *A. papillosa* larvae have yolk reserves in the stomach or left digestive diverticulum at hatching.

Frequency distributions of shell length of larvae of *H. crassicornis* that hatched out with

and without yolk reserves are shown in Fig. 10 and distributions of shell length of larvae fed suspensions of *Chlorella* and *D. tertiolecta* are shown in Figs. 11 and 12. Means and standard deviations of shell length for these larvae are summarized in Table 3. Only those larvae that had fed upon *D. tertiolecta* showed a significant deviation in the observed distribution of shell length from that predicted by a normal distribution ( $d_{\max}$ , Table 3). There are relatively fewer larvae feeding on algal suspensions (41%) than there were yolk-free

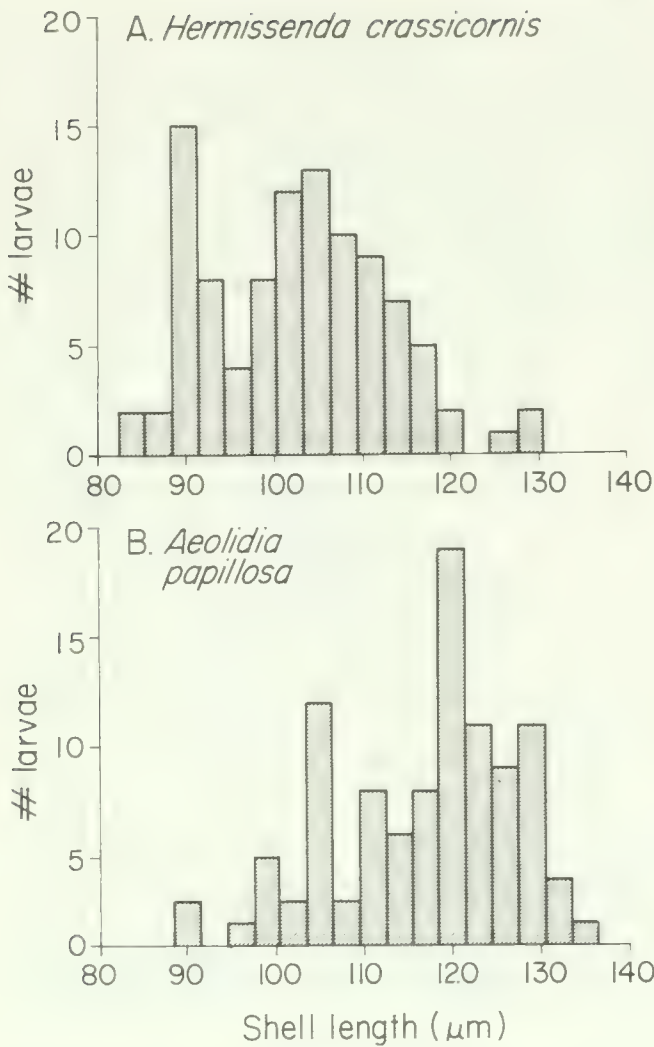

FIG. 9. Frequencies of shell length of *Hermissenda crassicornis* and *Aeolidia papillosa* at hatching (n = 100).

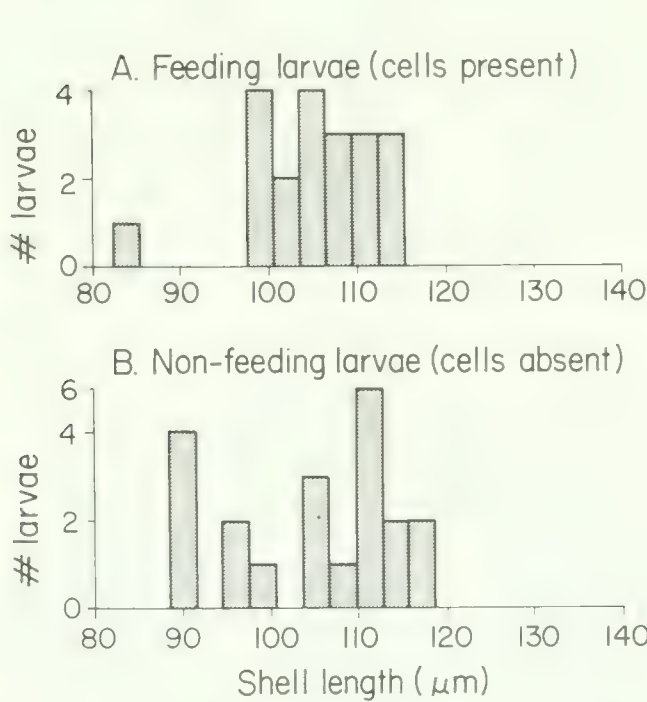

FIG. 11. Frequency distribution of shell length of larvae of *Hermissenda crassicornis* fed a suspension of *Chlorella* 580 (n = 20).

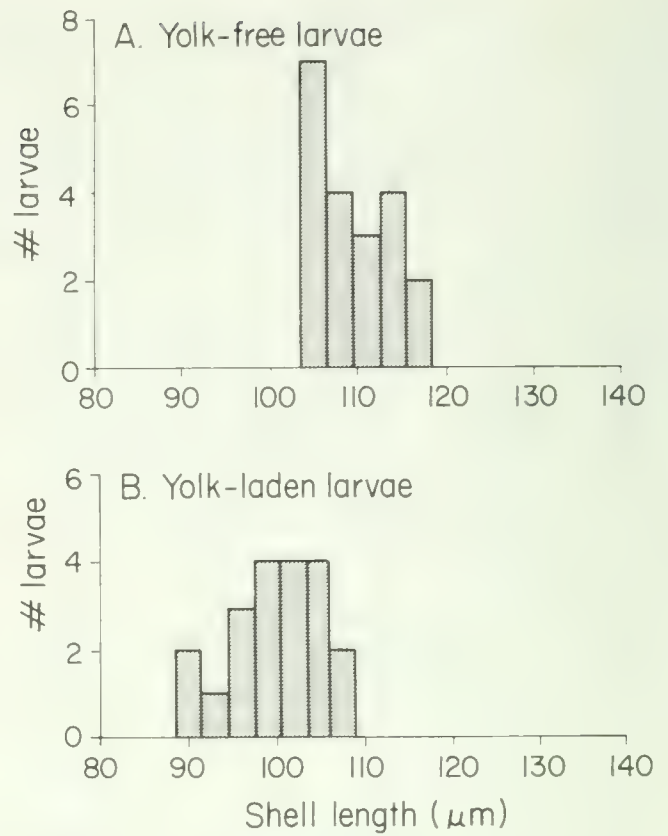

FIG. 10. Frequency distribution of shell length at hatching for *Hermissenda crassicornis* with and without yolk reserves (n = 20).

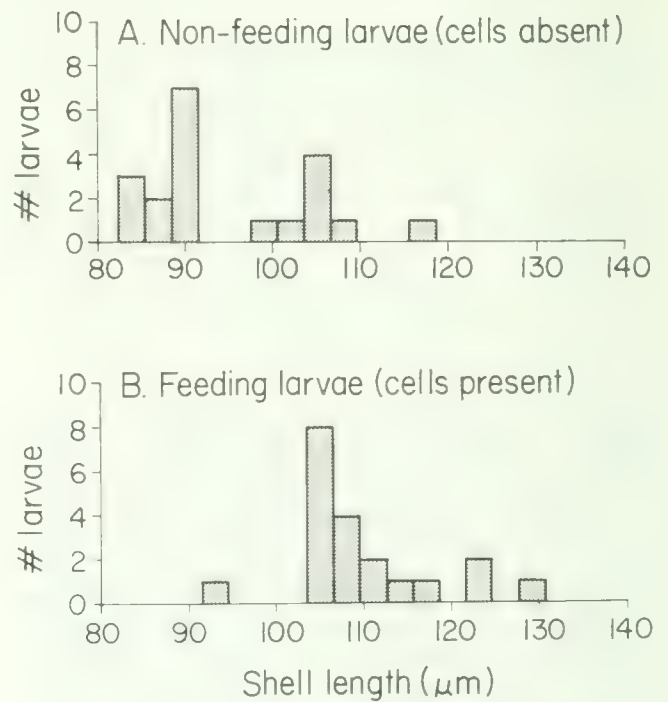

FIG. 12. Frequency distribution of shell length of larvae of *Hermissenda crassicornis* fed a suspension of *Dunaliella tertiolecta* (n = 20).

TABLE 3. Means and standard deviations of shell length ( $\mu\text{m}$ ) of veliger larvae of *Hermisenda crassicornis* employed in a 72 hour feeding experiment. Samples based on the presence or absence of yolk reserves were taken at the beginning of the experiment. Two groups of larvae were then separated from the culture. One group was fed a suspension of *Chlorella* 580 while the second group was fed a suspension of *Dunaliella tertiolecta*. At the end of the experiment shell length was measured for larvae that had ingested cells and that had not ingested cells from each of the suspensions. Percentages ( $n = 100$ ) of larvae with yolk, *Dunaliella* or *Chlorella* cells in the stomach or diverticulum are given in parentheses. Kolmogorov-Smirnov test for departure of the observed frequency distribution from normality is summarized under the column labeled  $d_{\text{max}}$ . Third and fourth moment statistics indicating either skewness or kurtosis of the observed frequency distributions are summarized in the columns labeled  $g_1$  and  $g_2$ , respectively.

	N	t(hr)	$\bar{X}(\mu\text{m}) \pm$	S	$d_{\text{max}}$	$g_1$	$g_2$
Yolk-free larvae	20	0	108.8	4.19	0.254	+3.386	-1.235
Yolk-laden larvae (49%)	20	0	99.3	5.22	0.084	-0.374	-0.701
<i>Dunaliella</i> fed to larvae							
cells in stomach (41%)	20	72	108.9	7.96	0.232	+0.698	+0.058
cells not in stomach	20	72	94.4	9.61	0.305*	+0.643	-0.753
<i>Chlorella</i> fed to larvae							
cells in stomach (41%)	20	72	104.4	7.00	0.131	-1.122	+1.745
cells not in stomach	20	72	103.8	9.31	0.152	-0.422	-1.244

\*Indicates significance at the 0.05 probability level.

TABLE 4. Student-Newman-Keuls test for multiple comparisons among means of shell length ( $\mu\text{m}$ ) of larvae of *Hermisenda crassicornis* employed in the feeding experiment outlined in Table 3. Significant differences among means are based on comparison with the Least Significant Range (LSR) statistic calculated according to the procedures outlined by Sokal & Rohlf (1969). The group means from Table 3 are ranked from lowest to highest. Abbreviations for each group are YF (yolk-free), YL (yolk-laden), CF (*Chlorella* cells present), CNF (*Chlorella* cells absent), DF (*Dunaliella* cells present), and DNF (*Dunaliella* cells absent). Those means that are not significantly different from one another ( $p > 0.05$ ) are shown by underscoring.

Rank	1	2	3	4	5	6
Group	DNF	YL	CNF	CF	YF	DF
Mean ( $\mu$ )	94.4	99.3	<u>103.8</u>	<u>104.4</u>	108.8	<u>108.9</u>

larvae at the beginning of the experiment (51%). Secondly, the relative number of larvae feeding on *Chlorella* was the same as that for *D. tertiolecta*. Multiple comparisons of means, and tests for significant differences among experimental groups show that at the beginning of the experiment ( $t = 0$  hr) yolk-free larvae were significantly larger than those with yolk reserves (t-test,  $p < 0.001$ , and Table 4). Similarly, larvae that had ingested *D. tertiolecta* were larger than those that had not fed. There was no significant difference ( $p > 0.05$ ) between yolk-free larvae at the beginning of the experiment and larvae that had ingested cells of either *Chlorella* or *D. tertiolecta* by the end of the experiment.

Frequency distributions of shell length for larvae of *A. papillosa* with and without yolk reserves at hatching are shown in Fig. 13. Distributions of shell length for larvae fed sus-

pensions of *Chlorella*, *D. tertiolecta*, *P. tricornutum*, and *Chlorella* + *P. tricornutum* are shown in Figs. 14, 15, 16 and 17, respectively. The distributions of shell length of *A. papillosa* larvae with and without yolk reserves are not significantly different ( $p > 0.05$ ) from a normal distribution while the distributions of shell length for those larvae which cleared *Chlorella* or *P. tricornutum* from suspension were significantly skewed ( $p < 0.05$ ) to the left (negative  $g_1$ ). Mean shell lengths and standard deviations for these larvae are summarized in Table 5. Unlike *H. crassicornis*, there is little difference between the relative numbers of larvae which were yolk-free and those which could clear algae from suspension. The relative numbers of yolk-free and of feeding larvae of *A. papillosa* were much less than those of *H. crassicornis*. Multiple comparisons of larval shell lengths of the various experi-

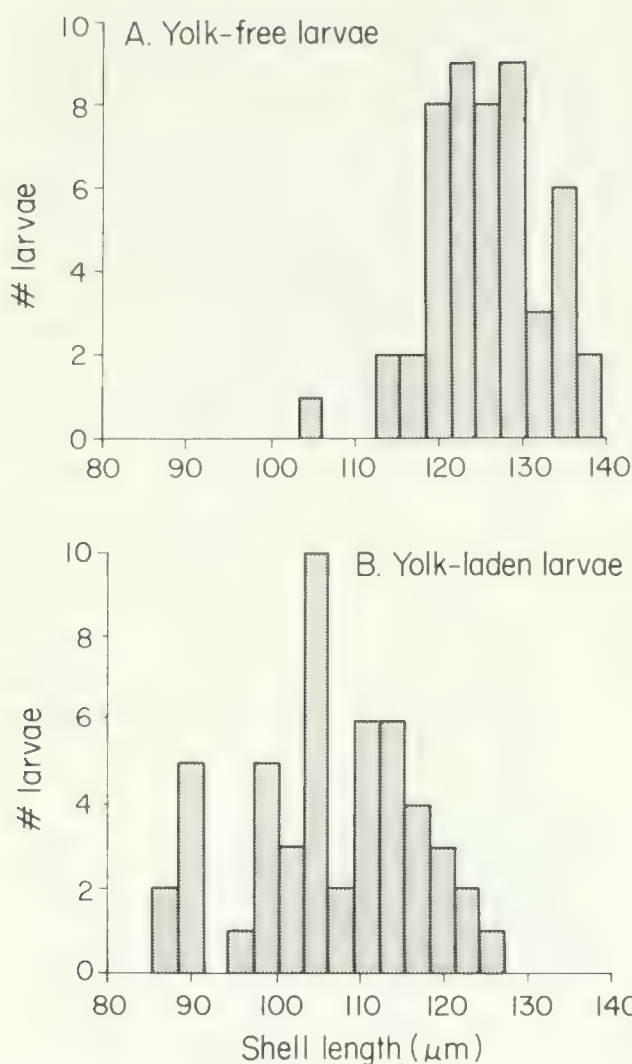

FIG. 13. Frequency distribution of shell length at hatching of larvae of *Aeolidia papillosa* with and without yolk reserves ( $n = 50$ ).

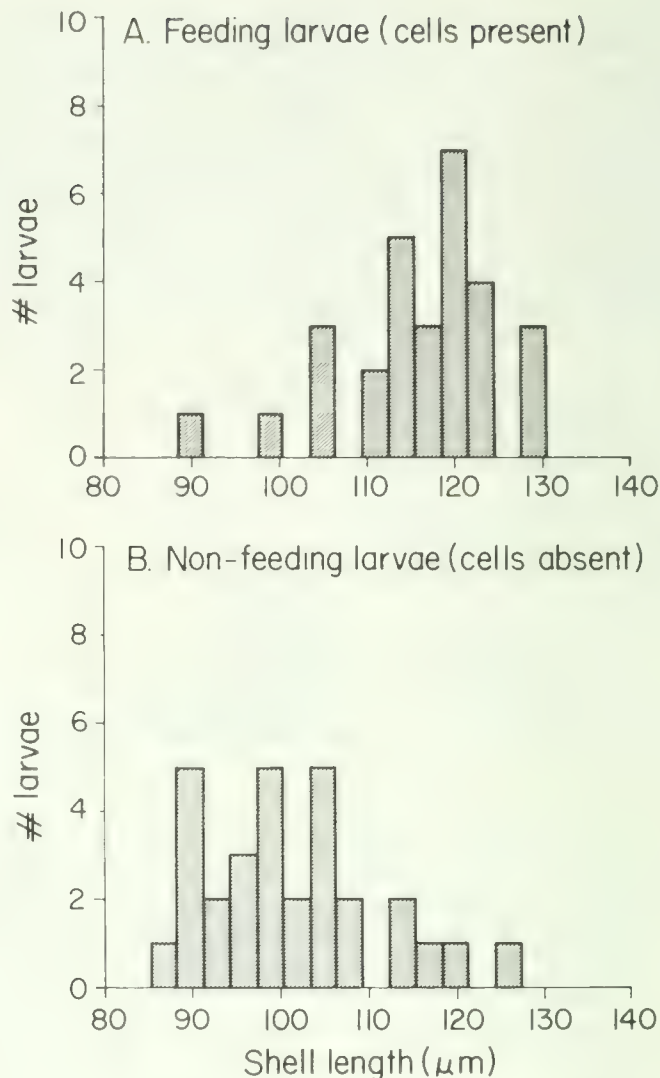

FIG. 14. Frequency distribution of shell length of larvae of *Aeolidia papillosa* fed a suspension of *Chlorella* 580 ( $n = 30$ ).

mental groups are presented in Table 6. At the beginning of the experiment, yolk-free larvae were significantly larger than their yolk-laden siblings (t-test,  $p < 0.001$ , and Table 6). Larvae that cleared algae from suspension were significantly larger ( $p < 0.05$ ) than those that had no algal cells in the stomach or diverticulum. There is no significant difference in shell length between larvae with yolk reserves at the beginning of the experiment and those which did not clear *D. tertiolecta* from suspension. Comparisons of shell length of larvae that had fed on the various algal suspensions show a significant difference between those which had consumed *Chlorella* and those that had ingested *P. tricornutum*. In a mixed suspension of *Chlorella* and *P. tricornutum*, larvae less than  $120 \mu\text{m}$  in shell length consumed only *Chlorella* while larvae greater than  $120 \mu\text{m}$  consumed both species of algae. Larvae ingesting both species of

algae had only *P. tricornutum* in the digestive diverticulum while *Chlorella* was found only in the stomach.

## DISCUSSION

### Developmental sequence

The significant variation in the number of ova per capsule deposited by *Hermisenda crassicornis* can be explained by the fact that successive spawning by the same individual often results in fewer ova per egg capsule, and in some instances this depletion of ova even results in formation of empty egg capsules at the terminal end of an egg string. Furthermore, larger individuals tend to produce more ova per egg capsule than do small individuals. This observation agrees with Harigan & Alkon's (1978) demonstration that the



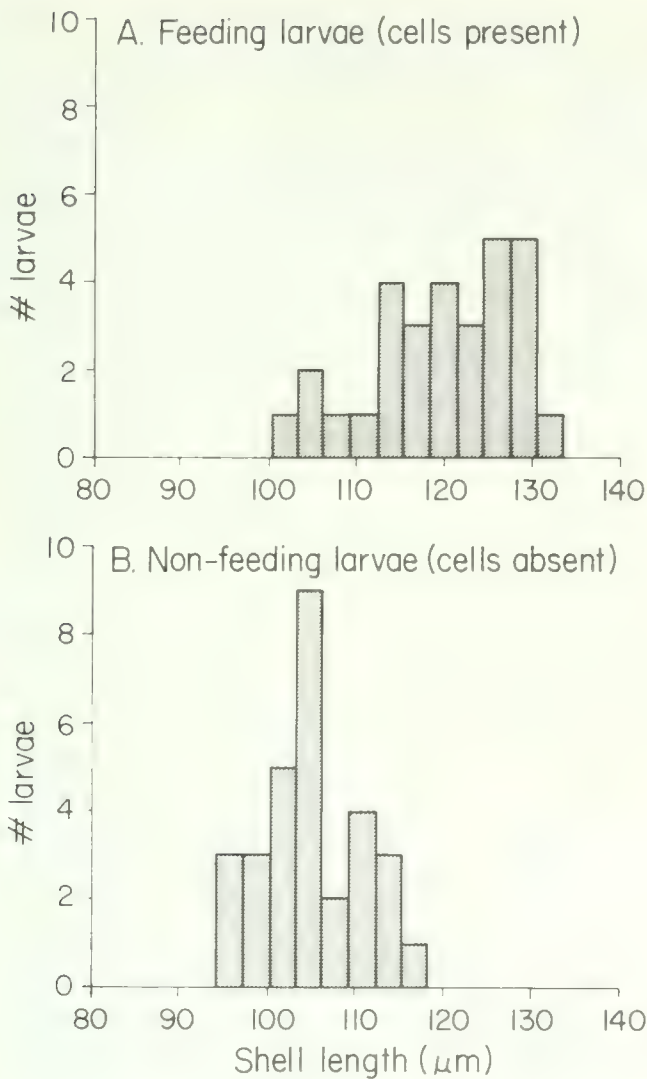

FIG. 15. Frequency distribution of shell length of larvae of *Aeolidia papillosa* fed a suspension of *Dunaliella* (n = 30).

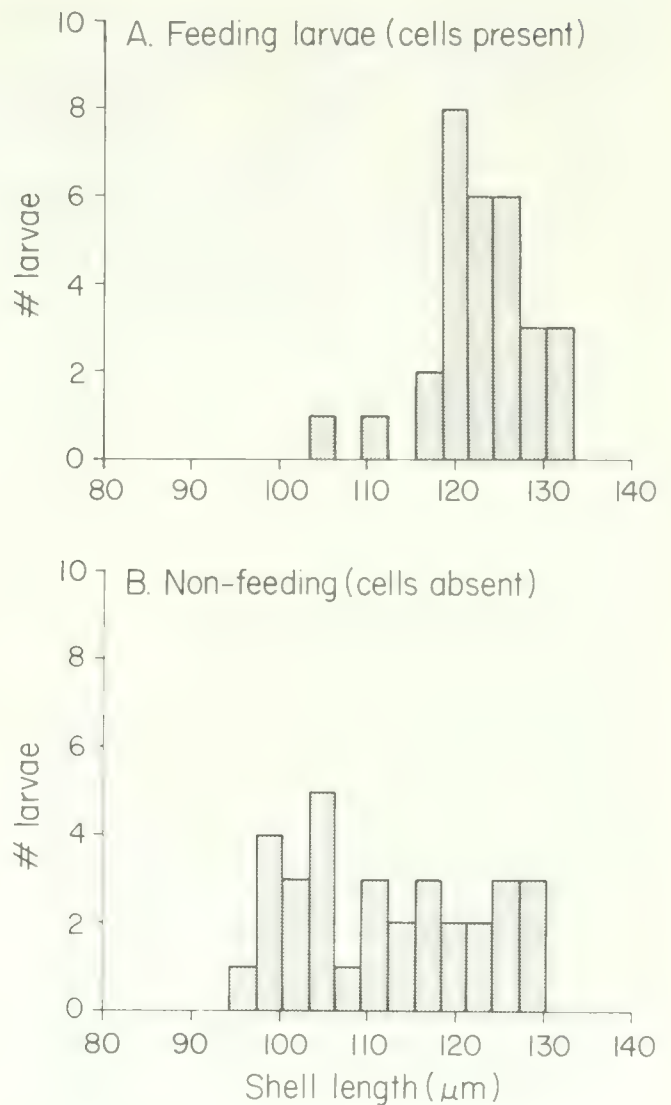

FIG. 16. Frequency distribution of shell length of larvae of *Aeolidia papillosa* fed a suspension of *Phaeodactylum tricornutum* (n = 30).

number of eggs per capsule increases linearly with weight of adult *H. crassicornis*.

Observations of cleavage, gastrulation, formation of early veliger, and veliger morphology of *Hermisenda crassicornis* and *Aeolidia papillosa* correspond closely with those of other cleioproct aeolids (Hadfield, 1963; Hamatani, 1967; Tardy, 1970; Rasmussen, 1951). Other workers concerned with early embryology in the Opisthobranchia have described a coelogastrula (Rasmussen, 1951; Rao & Alagarwami, 1960). Their illustrations, however, depict a sagittal cleft as described and illustrated by Raven (1958). At hatching, each species demonstrates planktotrophic development as defined by Thompson (1967). In each case, ova are small, egg capsules contain multiple embryos, development time to hatching is rapid, and free-swimming veligers lack eyespots, radulae, and propodial rudiments. The larval shell of each species is coiled (Type 1 of Thompson, 1961)

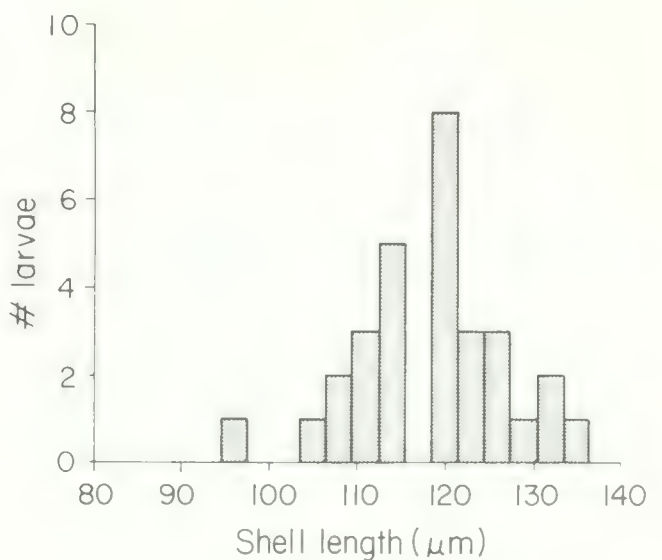

FIG. 17. Frequency distribution of shell length of larvae of *Aeolidia papillosa* fed a suspension of *Phaeodactylum* + *Chlorella* (n = 30).

TABLE 5. Means and standard deviations of shell length ( $\mu\text{m}$ ) of veliger larvae of *Aeolidia papillosa* employed in a 72 hour feeding experiment. Samples based on the presence or absence of yolk reserves were taken at the beginning of the experimental period. Four groups of larvae were then separated from the culture and fed suspensions of *Chlorella* 580, *Dunaliella tertiolecta*, *Phaeodactylum tricornutum*, and *Phaeodactylum* + *Chlorella*, respectively. At the end of the experiment shell length was measured for larvae that had ingested cells and that had not ingested cells from each of the suspensions. Percentages (n = 100) of larvae with yolk, *Chlorella*, *Dunaliella*, or *Phaeodactylum* cells in the stomach or diverticulum are given in parentheses. The remaining columns summarize departure from normality (Kolmogorov-Smirnov statistic,  $d_{\text{max}}$ ), skewness ( $g_1$ ), and kurtosis ( $g_2$ ) of the observed distributions of shell length.

	N	t(hr)	$\bar{X}(\mu\text{m}) \pm$	S	$d_{\text{max}}$	$g_1$	$g_2$
Yolk-free larvae	50	0	125.0	6.66	0.058	-0.367	+0.433
Yolk-laden larvae (91%)	50	0	106.0	9.97	0.093	-0.261	-0.647
<i>Chlorella</i> fed to larvae							
cells in stomach (16%)	30	72	115.3	8.60	0.108	-0.962*	+1.157
cells not in stomach	30	72	100.7	9.63	0.132	+0.666	-0.125
<i>Dunaliella</i> fed to larvae							
cells in stomach (8%)	30	72	119.1	8.01	0.173	-0.538	-0.635
cells not in stomach	30	72	104.6	5.60	0.187	+0.192	-0.702
<i>Phaeodactylum</i> fed to larvae							
cells in stomach (6%)	30	72	122.2	5.82	0.118	-0.829*	+1.382*
cells not in stomach	30	72	110.5	9.67	0.172	+0.232	-1.212
Mixed suspension fed to larvae							
cells in stomach (17%)	30	72	117.8	8.51	0.144	-0.311	+0.104
cells not in stomach	—	—	—	—	—	—	—

\*Indicates significance at the 0.05 probability level.

TABLE 6. Student-Newman-Keuls test for multiple comparisons among means of shell length ( $\mu\text{m}$ ) of larvae of *Aeolidia papillosa* employed in the feeding experiment outlined in Table 5. Significant differences among means are based on comparison with the Least Significant Range (LSR) statistic calculated according to the procedures outlined by Sokal & Rohlf (1969). Group means from Table 5 are ranked from lowest to highest. Those means that are not significantly different ( $p > 0.05$ ) from one another are shown by underscoring. Abbreviation for each group are YF (yolk-free), YL (yolk-laden), CF (*Chlorella* cells present), CNF (*Chlorella* cells absent), DF (*Dunaliella* cells present), DNF (*Dunaliella* cells absent), PF (*Phaeodactylum* cells present), PNF (*Phaeodactylum* cells absent), and MF (*Phaeodactylum* or *Chlorella* present).

Rank	1	2	3	4	5	6	7	8	9
Group	CNF	DNF	YL	PNF	CF	MF	DF	PF	YF
Mean ( $\mu\text{m}$ )	<u>100.7</u>	<u>104.6</u>	106.0	110.5	115.5	117.8	119.1	122.2	125.0

and sculptured (Fig. 5). Harrigan & Alkon (1978) report an unsculptured larval shell in their study of *H. crassicornis*. This difference in observations is noteworthy and may reflect geographical variation between populations of *H. crassicornis* occurring in Monterey Bay, Harrigan & Alkon's (1978) collection site, and in Tomales Bay, 180 km north.

#### Larval dimorphism

Systematic review of development in the Aeolidioidea reveals the following associa-

tions. Features of shell morphology such as shape (inflated vs. coiled), and presence of striations are more conservative at the generic level than morphology of the soft parts (Thompson, 1961). The inflated larval shell is found among pleuroproct aeolidioideans while cleioprocts such as *Hermisenda crassicornis* and *Aeolidia papillosa* possess only coiled shells. Several developmental types (i.e., planktotrophic, lecithotrophic, encapsulated veliger, and ametamorphic) occur commonly among congeners. For instance, *Aeolidiella* contains species with plankto-

trophic, lecithotrophic, and encapsulated veliger larvae (Hadfield, 1963; Hamatani, 1967; Rao & Alagarswami, 1960; Tardy, 1970). *Coryphella* has species with planktotrophic and ametamorphic development (Bridges & Blake, 1972; Hurst, 1967; Morse, 1971). *Phestilla melanobranchia* is planktotrophic but possesses eyespots which are characteristic of lecithotrophic larvae (Harris, 1975), while *P. sibogae* is lecithotrophic but possesses great flexibility in its ability to survive in the plankton and metamorphose (Hadfield, 1972; Bonar & Hadfield, 1974). Variations in developmental type have been observed at the species level for *Cuthona nana* (Harris, Wright & Rivest, 1975; Rivest, 1978), *Tenellia pallida* (Eyster, 1979), and *Spurilla neapolitana* (Clark & Goetzfried, 1978). Bonar (1978) points out that the morphology of larvae competent to metamorphose and the events which characterize their subsequent metamorphosis are virtually identical for lecithotrophic and planktotrophic forms. However, premetamorphic larvae may be morphologically disparate and show variations that may be ecologically or evolutionarily important. Developmental variations in morphology that precede competency may be ecologically adaptive by allowing portions of the larval population to survive seasonal or geographic changes in the environment or enable colonization of new habitats. Such variations may also be evolutionarily adaptive because they provide the population with larval phenotypes that may be responsive to the selective pressures that lead to the different developmental types and life history patterns (Strathmann, 1974; Vance, 1973a,b; and the arguments of Underwood, 1974). For instance, Clark & Goetzfried (1978) theorize that nudibranch species with gamete size and number intermediate to extremes encountered in, for example, planktotrophic and lecithotrophic larvae should be capable of switching developmental types if ecological conditions vary, provided that genetic differences between developmental types are small. They suggest that interruption of adult food supply may induce development of larvae with higher dispersal ability.

In a morphological context, larvae of *H. crassicornis* and *A. papillosa* are planktotrophic. At first glance, the polytypic occurrence of yolk reserves seems to be a lecithotrophic accommodation to reaching competency. If the dimorphism shown for *H. crassicornis* and *A. papillosa* truly reflects dif-

ferences between lecithotrophic and planktotrophic larvae, then one would expect to see large, yolky larvae developing from large eggs and small, yolk-free larvae developing from small eggs. However, in the cases of *H. crassicornis* and *A. papillosa*, yolk-free larvae are larger than their yolk-laden siblings and both types of larvae develop from uniformly small ova. Clark & Goetzfried (1978) have documented shifts in production of lecithotrophic larvae to planktotrophic larvae by adult *Spurilla neapolitana* (Delle Chiaje) which had been starved prior to egg mass deposition. The shift from lecithotrophic to planktotrophic larvae was accompanied by a decrease in egg diameter and change from single to multiple embryo capsules. The nutritional state of parental *H. crassicornis* and *A. papillosa* was not followed during the present study and therefore provides no clue to the cause of dimorphic larvae. The size dependent distribution of yolk reserves could result from premature release of slow-developing embryos from egg capsules ruptured by their faster developing, yolk-free siblings. However, yolk-laden siblings of *A. papillosa* were observed hatching from a common egg capsule which contained no yolk-free larvae. Harrigan & Alkon (1978) have shown that *H. crassicornis* requires 34 days (14.1°C) to reach competency to metamorphose. Regardless of the mechanism which induces larval dimorphism, the presence of yolk reserves at hatching could significantly decrease the dependency of larvae on phytoplankton if yolk-laden and yolk-free larvae require the same amount of time after hatching to reach competency. If the presence of yolk reserves signals an increase in the time which larvae must spend in the plankton before they reach metamorphic competency, then the dependency of larvae on phytoplankton will be decreased while the dispersal area of the larvae will be increased (Strathmann, 1974).

The production of slowly developing, widely dispersed, yolk-laden larvae along with faster developing, yolk-free siblings seems consistent with the opportunistic life history pattern of *Hermisenda crassicornis* documented by Birkeland (1974) and Harrigan & Alkon (1978). Adult *H. crassicornis* occur in a wide range of habitats, are eurytrophic, breed sub-annually, have a short generation time (2.5 months), and have a brief life span of 5–6 months. Larval *H. crassicornis* can be induced to metamorphose on a variety (at least three species) of hydroids.

### Larval feeding

Observations concerning treatment of food by veliger larvae of *Hermissenda crassicornis* and *Aeolidia papillosa* are, with one exception, in agreement with those of Thompson (1959) for *Archidoris pseudoargus*, *Trinchesia aurantia* and *Eubbranchus exiguus*. The exception noted here is the transport of large undigested cells along an anterior food groove (Fig. 7b) to the confluence of the stomach and intestine. This observation is in agreement with that of Fretter & Montgomery (1968) for the treatment of food by 19 species of prosobranch veligers.

The initial rate of particle ingestion appears to accommodate the physical capacity of the stomach to retain algal cells. Subsequent occasional feeding most likely accommodates the rates of digestion and defecation. Veliger larvae of *H. crassicornis* are capable of luxury feeding greatly beyond their immediate needs. This point is corroborated by the high residence time of cells in the stomach and diverticulum (Fig. 8).

Feeding ability of recently hatched larvae of *H. crassicornis* is determined by the presence of yolk reserves, the size of the larva, and the size of algal cell available for ingestion. Obviously, those larvae that have their esophagus, stomach, and diverticulum filled with yolk cells are unable to feed. Some larvae, those with their esophagus and stomach free of yolk cells, had yolk cells and algae in the diverticulum simultaneously. Thus, the persistence of yolk reserves after hatching may not completely deter yolk-laden larvae from feeding. Those larvae capable of feeding apparently do so in a selective fashion. In the case of *H. crassicornis*, there is no significant difference in shell length between yolk-free larvae and larvae that ingested *Chlorella* or *D. tertiolecta* (Table 4). Yet, there is a difference in percent of yolk-free larvae (51%) and larvae that ingested either *Chlorella* or *D. tertiolecta* by the end of the experiment (41%, Table 3). Fewer larvae were ingesting cells of either species of alga than would be predicted by the percentage of yolk-free larvae at hatching. This is particularly surprising for two reasons. Some yolk-laden larvae are able to ingest algal cells as described above. Also, one would expect the frequency of yolk-free larvae (i.e., larvae definitely able to ingest algal cells) to increase over time as yolk reserves are consumed. This discrepancy may be explained by the difference in size between those larvae that in-

gested *Chlorella* 580 and those that ingested *Dunaliella tertiolecta*. The larger larvae ate the larger algal cells (viz., *D. tertiolecta*), while small larvae ingested small algal cells (viz., *Chlorella*). Fig. 10 shows that larvae of *H. crassicornis* less than 103  $\mu\text{m}$  in shell length also possess yolk reserves. However, larvae less than 103  $\mu\text{m}$  (and presumably yolk-free) ingested *Chlorella* (Fig. 11), but for the most part, not *D. tertiolecta* (Fig. 12). If feeding ability were restricted to only yolk-free larvae, then one would expect larvae less than 103  $\mu\text{m}$  to be nonfeeding. On the other hand, most *H. crassicornis* larvae greater than about 107  $\mu\text{m}$  in shell length are yolk-free and would be expected to feed on cells which they are physically able to ingest. This is not the case with *Chlorella*, where about 50% of the non-feeding larvae were larger than 107  $\mu\text{m}$  and were, presumably, yolk-free (Fig. 11). The converse of this situation arises in the case of *D. tertiolecta*, where most larvae greater than 107  $\mu\text{m}$  had ingested cells (Fig. 12). Thus in each test flask not all those larvae capable of ingesting algal cells were successful, because of limitations imposed by either their mechanical ability to handle large particles (Strathmann, 1971) or by particle size selection (Paulson & Scheltema, 1968). These observations suggest that as larvae grow they may be able to ingest, and therefore select, proportionately larger particles. Harrigan & Alkon (1978) observed that to develop in reasonable numbers to a state competent to metamorphose, veligers of *H. crassicornis* require algal cells larger (10–11  $\mu\text{m}$ ) than the small (5–6  $\mu\text{m}$ ) cells of *Isochrysis* and *Monochrysis* commonly fed molluscan larvae.

Similar arguments regarding feeding ability apply to the larvae of *A. papillosa*. Increasing means of shell length (Table 5) as a function of cell size ingested (*Chlorella* < *Dunaliella* < *Phaeodactylum*) suggest that small larvae are physically incapable of ingesting large algal cells such as *P. tricornutum* and large larvae select large algal cells. Fig. 13 shows that larvae of *A. papillosa* less than 105  $\mu\text{m}$  in shell length contain yolk reserves while those greater than about 125  $\mu\text{m}$  do not contain yolk reserves. A higher proportion of larvae less than 105  $\mu\text{m}$  ingested *Chlorella* (~16%) than ingested *D. tertiolecta* (~10%) or *P. tricornutum* (~3%). Fewer larvae greater than 125  $\mu\text{m}$  ingested *Chlorella* (~10%, Fig. 14) than ingested either *D. tertiolecta* or *P. tricornutum* (~37%, Figs. 15 and 16). In a mixed suspension of *Chlorella* and *P. tri-*

*cornutum*, larvae greater than 120  $\mu\text{m}$  consumed both species of algae. The larger alga, *P. tricornutum*, may have been consumed first since only *P. tricornutum* was present in the digestive diverticulum and *Chlorella* was found only in the stomach. However, random ingestion of particles followed by sorting them by size for passage into the digestive diverticulum cannot be discounted as an alternative explanation to size selective ingestion.

### CONCLUSIONS

Larvae of *Hermisenda crassicornis* and *Aeolidia papillosa* are planktotrophic in the morphological (Thompson, 1967), morphogenetic (Bonar, 1978; Harrigan & Alkon, 1978) and functional sense of the term. At hatching, larvae of both species are polytypic with respect to the presence of yolk reserves. Feeding ability of recently hatched larvae of both species is determined by the presence of yolk reserves, the size of larvae, and the size of algal cell available for ingestion. The larvae of both species either do not need to feed (yolky larvae) when introduced into the plankton or can feed greatly beyond their immediate needs (yolk-free larvae) and may, therefore, survive by sporadic feeding in an environment where phytoplankton may have spatially (Mackas & Boyd, 1979; Platt, Dickie & Trites, 1970) and temporally (Malone, 1977; Peterson & Miller, 1975) patchy distributions. The presence of yolk reserves in the larvae of *H. crassicornis* and *A. papillosa* appears to allow a portion of the larvae temporary independence of phytoplankton food and, perhaps, increased dispersal without the risks of delayed metamorphosis.

### ACKNOWLEDGEMENTS

I thank Drs. James A. Blake, Steven Obrebski, and Edmund H. Smith for providing encouragement and advice while this research was being performed at the Pacific Marine Station. Dr. Melbourne Carriker, Dr. Charles Epifanio, Dr. Robert Palmer, Mr. Robert Prezant, Ms. Betsy Brown, and Ms. Lindy Eyster reviewed the manuscript and contributed many helpful suggestions. Final figures were prepared by Mrs. Jan Sick and photographic prints were prepared by Mr. Walter Kay.

### LITERATURE CITED

- BIRKELAND, C., 1974, Interactions between a sea pen and seven of its predators. *Ecological Monographs*, 44: 211–232.
- BONAR, D. B., 1978, Morphogenesis at metamorphosis in opisthobranch molluscs. In: F.-S. CHIA & M. RICE (eds.), *Settlement and metamorphosis of marine invertebrate larvae*. Elsevier, New York, p. 177–196.
- BONAR, D. G. & HADFIELD, M. G., 1974, Metamorphosis of the marine gastropod *Phestilla sibogae* Bergh (Nudibranchia: Aeolidacea). I. Light and electron microscope analysis of larval and metamorphic stages. *Journal of Experimental Marine Biology and Ecology*, 16: 227–255.
- BRIDGES, C. & BLAKE, J. A., 1972, Embryology and larval development of *Coryphella trilineata* O'Donoghue, 1921 (Gastropoda: Nudibranchia). *Veliger*, 14: 293–297.
- CLARK, K. & GOETZFRIED, A., 1978, Zoogeographic influences on developmental patterns of North Atlantic Ascoglossa and Nudibranchia with a discussion of egg size and number in opisthobranchia. *Journal of Molluscan Studies*, 44: 283–294.
- EYSTER, L., 1979, Reproduction and developmental variability in the opisthobranch *Tenellia pallida*. *Marine Biology*, 51: 133–140.
- FRETTER, V., 1967, The prosobranch veliger. *Proceedings of the Malacological Society of London*, 37: 357–366.
- FRETTER, V. & MONTGOMERY, M. C., 1968, The treatment of food by prosobranch veligers. *Journal of the Marine Biological Association of the United Kingdom*, 48: 499–520.
- GUILLARD, R. R. L. & RYTHER, J. H., 1962, Studies on marine planktonic diatoms. I. *Cyclotella nana* Hustedt and *Detonula confervacea* (Cleve) Gram. *Canadian Journal of Microbiology*, 8: 229–239.
- HADFIELD, M. G., 1963, The biology of nudibranch larvae. *Oikos*, 14: 85–95.
- HADFIELD, M. G., 1972, Flexibility in larval life patterns. *American Zoologist*, 12: 721.
- HAMATANI, I., 1967, Notes on veligers of Japanese opisthobranchs (7). *Publications of the Seto Marine Biological Laboratory*, 15: 121–131.
- HARRIGAN, J. F. & ALKON, D. L., 1978, Larval rearing, metamorphosis, growth and reproduction of the aeolid nudibranch *Hermisenda crassicornis* (Eschscholtz, 1831) (Gastropoda: Opisthobranchia). *Biological Bulletin*, 154: 430–439.
- HARRIS, L. G., 1975, Studies on the life history of two coral-eating nudibranchs of the genus *Phestilla*. *Biological Bulletin*, 149: 539–550.
- HARRIS, L. G., WRIGHT, L. W. & RIVEST, B. R., 1975, Observations on the occurrence and biology of the aeolid nudibranch *Cuthona nana* in New England waters. *Veliger*, 17: 264–268.
- HURST, A., 1967, The egg masses and veligers of

- thirty northeast Pacific opisthobranchs. *Veliger*, 9: 255–287.
- KNIGHT-JONES, E. W., 1954, Relations between metachronism and the direction of ciliary beat in Metazoa. *Quarterly Journal of Microscopical Science*, 95: 503–521.
- MACKAS, P. L. & BOYD, C. M., 1979, Spectral analysis of zooplankton spatial heterogeneity. *Science*, 204: 62–64.
- MALONE, T. C., 1977, Light saturated photosynthesis by phytoplankton size fractions in the New York Bight, U.S.A. *Marine Biology*, 42: 281–292.
- MORSE, M. P., 1971, Biology and life history of the nudibranch mollusc, *Coryphella stimpsoni* (Verrill, 1979). *Biological Bulletin*, 140: 84–94.
- PAULSON, T. C. & SCHELTEMA, R. S., 1968, Selective feeding on algal cells by veliger larvae of *Nassarius obsoletus* (Gastropoda: Prosobranchia). *Biological Bulletin*, 134: 481–489.
- PERRON, F. E. & TURNER, R. D., 1977, Development, metamorphosis, and natural history of the nudibranch *Doridella obscura* Verrill (Corambidae: Opisthobranchia). *Journal of Experimental Marine Biology and Ecology*, 27: 171–185.
- PETERSON, W. T. & MILLER, C. B., 1975, Year to year variations in the planktology of the Oregon upwelling zone. *Fishery Bulletin*, 73: 642–653.
- PLATT, T., DICKIE, L. M. & TRITES, R. W., 1970, Spatial heterogeneity of phytoplankton in a near shore environment. *Journal of the Fisheries Research Board of Canada*, 27: 1453–1473.
- RAO, K. V. & ALAGARSWAMI, K., 1960, An account of the structure and early development of a new species of nudibranchiate gastropod, *Eolidina (Eolidina) mannarensis*. *Journal of the Marine Biological Association of India*, 2: 6–17.
- RASMUSSEN, E., 1951, Faunistic and biological notes on marine invertebrates. II. The egg masses and larvae of some Danish marine gastropods. *Videnskabelige Meddelelser fra Dansk Naturhistorisk Forening*, 113: 201–249.
- RAVEN, C. P., 1958, *Morphogenesis: the analysis of molluscan development*. Pergamon, London, 311 p.
- RIVEST, B. R., 1978, Development of the eolid nudibranch *Cuthona nana* (Alder and Hancock, 1842), and its relationship with a hydroid and hermit crab. *Biological Bulletin*, 154: 157–175.
- SOKAL, R. R. & ROHLF, F. J., 1969, *Biometry: the principles and practice of statistics in biological research*. Freeman, San Francisco. 776 p.
- STRATHMANN, R. B., 1971, The feeding behavior of planktotrophic echinoderm larvae: Mechanisms, regulation and rates of suspension feeding. *Journal of Experimental Marine Biology and Ecology*, 6: 109–160.
- STRATHMANN, R. B., 1974, The spread of sibling larvae of sedentary marine invertebrates. *American Naturalist*, 108: 29–44.
- TARDY, J., 1970, Contribution à l'étude des métamorphoses chez les nudibranches. *Annales des Sciences Naturelles, Zoologie et Biologie Animale*, ser. 12, 12: 299–370.
- THOMPSON, T. E., 1958, The natural history, embryology, larval biology and post-larval development of *Adalaria proxima* (Alder and Hancock), (Gastropoda: Opisthobranchia). *Philosophical Transactions of the Royal Society of London*, ser. B, 242: 1–58.
- THOMPSON, T. E., 1959, Feeding in nudibranch larvae. *Journal of the Marine Biological Association of the United Kingdom*, 38: 239–248.
- THOMPSON, T. E., 1961, The importance of the larval shell in the classification of the Sacoglossa and the Acoela. *Proceedings of the Malacological Society of London*, 34: 233–238.
- THOMPSON, T. E., 1962, Studies on the larval ontogeny of *Tritonia hombergi* Cuvier (Gastropoda: Opisthobranchia). *Philosophical Transactions of the Royal Society of London*, ser. B, 245: 171–218.
- THOMPSON, T. E., 1967, Direct development in a nudibranch, *Cadlina laevis*, with a discussion of developmental processes in Opisthobranchia. *Journal of the Marine Biological Association of the United Kingdom*, 47: 1–22.
- UNDERWOOD, A. H., 1974, On models for reproductive strategy in marine benthic invertebrates. *American Naturalist*, 108: 874–878.
- VANCE, R. R., 1973a, On reproductive strategies in marine benthic invertebrates. *American Naturalist*, 107: 339–351.
- VANCE, R. R., 1973b, More on reproductive strategies in marine benthic invertebrates. *American Naturalist*, 107: 353–361.

OBSERVATIONS ON THE ANATOMY AND LIFE HISTORY OF  
*MODULUS MODULUS* (PROSOBRANCHIA: MODULIDAE)

Richard S. Houbbrick

*Department of Invertebrate Zoology (Mollusks), National Museum of Natural History,  
Smithsonian Institution, Washington, D.C. 20560, U.S.A.*

ABSTRACT

*Modulus modulus* (Linnaeus), family Modulidae, is a style-bearing marine prosobranch in the superfamily Cerithiacea. It differs from other cerithiaceans by its turbinate shell and certain anatomical features. The basic anatomy of *Modulus* is that of a typical mesogastropod but the open pallial gonoducts are similar to those of other cerithiaceans. Characteristic anatomical features are the large hypobranchial gland, aphyallic males, open pallial oviduct with complex inner ducts, and the forward position of the salivary glands relative to the nerve ring.

*Modulus modulus* lives on marine angiosperm grasses and feeds primarily on diatoms.

Fertilization is internal and is effected by spermatophores that contain eupyrene and apyrene sperms. The life cycle of a population from Fort Pierce, Florida lasts about one year. Mating occurs in early winter and spawning in spring. Females have complex pallial oviducts and ovipositors. Spawn masses are cylindrical, comprised of gelatinous tubes and deposited on marine grasses. Development is direct. Young snails emerge after three weeks of incubation.

Within the Cerithiacea, the Modulidae are phylogenetically close to the Cerithiidae and Potamididae.

INTRODUCTION

The family Modulidae Fischer consists of a single genus, *Modulus* Gray, 1842, and about six species that are largely confined to the shallow waters of tropical and subtropical regions. These prosobranchs are epifaunal, style-bearing, microphagous herbivores and are moderately small animals, having shells 10-25 mm in length. *Modulus* species occur in the fossil record back to the Cretaceous (Dall, 1892). Historically, the family Modulidae has been assigned to the large mesogastropodan superfamily Cerithiacea Fleming, which is comprised of numerous families of herbivorous snails, having open pallial gonoducts, aphyallic males, and shells that are usually high-spired and elongate. Members of the Modulidae, however, differ strikingly from all other cerithiaceans by their top-shaped, trochiform shells. Although the family Modulidae has been included in most of the classic iconographies and the western Atlantic species have recently been monographed by Abbott (1944), there have been no serious anatomical or life history studies of the group. Its standing as a valid family and relationship to other higher taxa in the superfamily has been conjectural.

This paper addresses the functional mor-

phology, developmental biology and aspects of the life history of *Modulus modulus* (Linnaeus, 1758), the type-species of the genus. On the basis of these data, the relationship of the Modulidae to other families of the Cerithiacea will be considered.

HISTORICAL REVIEW

The family Modulidae has been reviewed by A. Adams (1851), Sowerby (1855), Reeve (1865), Tryon (1887) and more recently by Abbott (1944), who limited his work to the western Atlantic. The older monographs were confined to strict conchological taxonomy and did not address relationships above the alpha level.

The anatomy of *Modulus* was first described by Risbec (1927), who dealt with *Modulus candidus* Petit, 1853 [= *M. tectum* (Gmelin, 1791)]. He placed the Modulidae between the Strombidae and Cerithiidae. Although Risbec (1927) noted the aphyallic condition of males, he did not adequately study the reproductive tract and neglected to describe the complex pallial gonoducts. His other anatomical observations are sketchy and sometimes erroneous. Abbott (1944) figured and described the external soft parts of

the head and foot of *Modulus modulus* and presented a few brief notes on its ecology.

To my knowledge, only two papers have considered the developmental biology of *Modulus*: Lebour (1945: 470–471) has described the spawn and larvae of *Modulus modulus*, and more recently Bandel (1976: 258–259) described and figured the spawn and larvae of *Modulus modulus* and *Modulus carchedonius* (Lamarck, 1822). Both of these descriptions are brief and the taxonomic identity of the species is questionable. This will be discussed in more detail later in this paper.

Mook (1977) is the only author to have written anything about the ecology of *Modulus*. His study was concerned with the role of *Modulus modulus* as a control of fouling organisms on marine angiosperm grasses and did not consider the ecology of *Modulus*.

To my knowledge, nothing more has been published about the biology of *Modulus* species, despite the fact that some species, such as *Modulus modulus*, commonly occur in great numbers and are easily collected and observed.

## MATERIALS AND METHODS

*Modulus modulus* specimens were obtained from a large population in a seagrass bed north of Link Port on the west bank of the Indian River lagoon near Fort Pierce, Florida (27°32.1'N, 80°20.9'W). For a more detailed description of this site, see Young et al. (1976). The subtidal site consisted of dense stands of *Halodule wrightii* Ascherson and occasional beds of *Thalassia testudinum* König & Sims interspersed with sandy patches. Snails from this population were studied during January, February, May and September of 1978 and in January of 1979. Living animals were studied in the field and in sea water aquaria or petri dishes placed under a Wild M-5 stereo dissecting microscope. Animals were extracted from their shells and relaxed in a 7.5 percent solution of

MgCl<sub>2</sub>, and dissected in an anesthetized state. Carmine particles were used to determine ciliary tracts and a one percent Methylene Blue aqueous solution was used as a vital stain. Stomach contents and fecal pellets were studied under a compound microscope to determine the algae that were ingested. Animals were fixed in Bouin's fluid, embedded in paraffin, sectioned at 9.0 μm, and stained with Basic Fuchsin Picric Indigo Carmine for histological studies. Photomicrographs of sections were taken with a Zeiss photomicroscope-3. Spermatozoa were fixed in a 2.5 percent gluteraldehyde solution in 0.2 molar Mellonig's phosphate buffer and were brought up to 50 percent EtOH and air dried on cover slips prior to SEM studies. Spermatophores, eggs and embryos were prepared for critical point drying by fixation in 2.5 percent gluteraldehyde in 0.2 molar Mellonig's phosphate buffer at pH 7.4. Material was rinsed in distilled water, dehydrated and the critical point drying was done with liquid CO<sub>2</sub>. Spermatozoa, spermatophores, eggs, embryos, radulae and embryonic shells were studied with a Nova-Scan SEM. Observations on pairing, spawning and feeding were made in the field and in the lab. Eggs and embryos were maintained in culture dishes with daily sea water changes until hatching. Measurements of eggs and embryos were made with an ocular micrometer.

In addition to the above work, the anatomy of *Modulus tectum* (Gmelin, 1791) was studied at Suva, Fiji for comparison with that of *Modulus modulus*, but this work was only at a superficial level.

All measurements are relative to average sized snails (see Table 1).

## ANATOMY

*Shell* (Fig. 1a–c).—The shell is top-shaped, umbilicate, wider than high, and consists of 5–6 strongly convex, angulate whorls of which the body whorl is disproportionately large.

---

FIG. 1. Shells, spawn mass and embryos of *Modulus modulus*; **a–c**, Apical, apertural and basal views of adult shell with typical sculpture; **d–f**, Apical, apertural and side view of young shell. Note sharp transition between sculpture of embryonic shell and that of teleoconch (1.5 mm wide); **g**, Newly hatched snail showing distinctive sculpture (0.5 mm long); **h**, Five day old snail showing sharp transition in sculpture between embryonic shell and new growth area of outer lip (0.8 mm long); **i**, Portion of spawn mass critical point dried and fractured to show hyaline capsule surrounding each embryo. Embryonic shell sculpture is visible beneath surface of each capsule; **j**, Typical spawn mass attached to grass blade (9 mm long); **k**, Portion of spawn mass with surface debris removed to display encapsulated embryos.



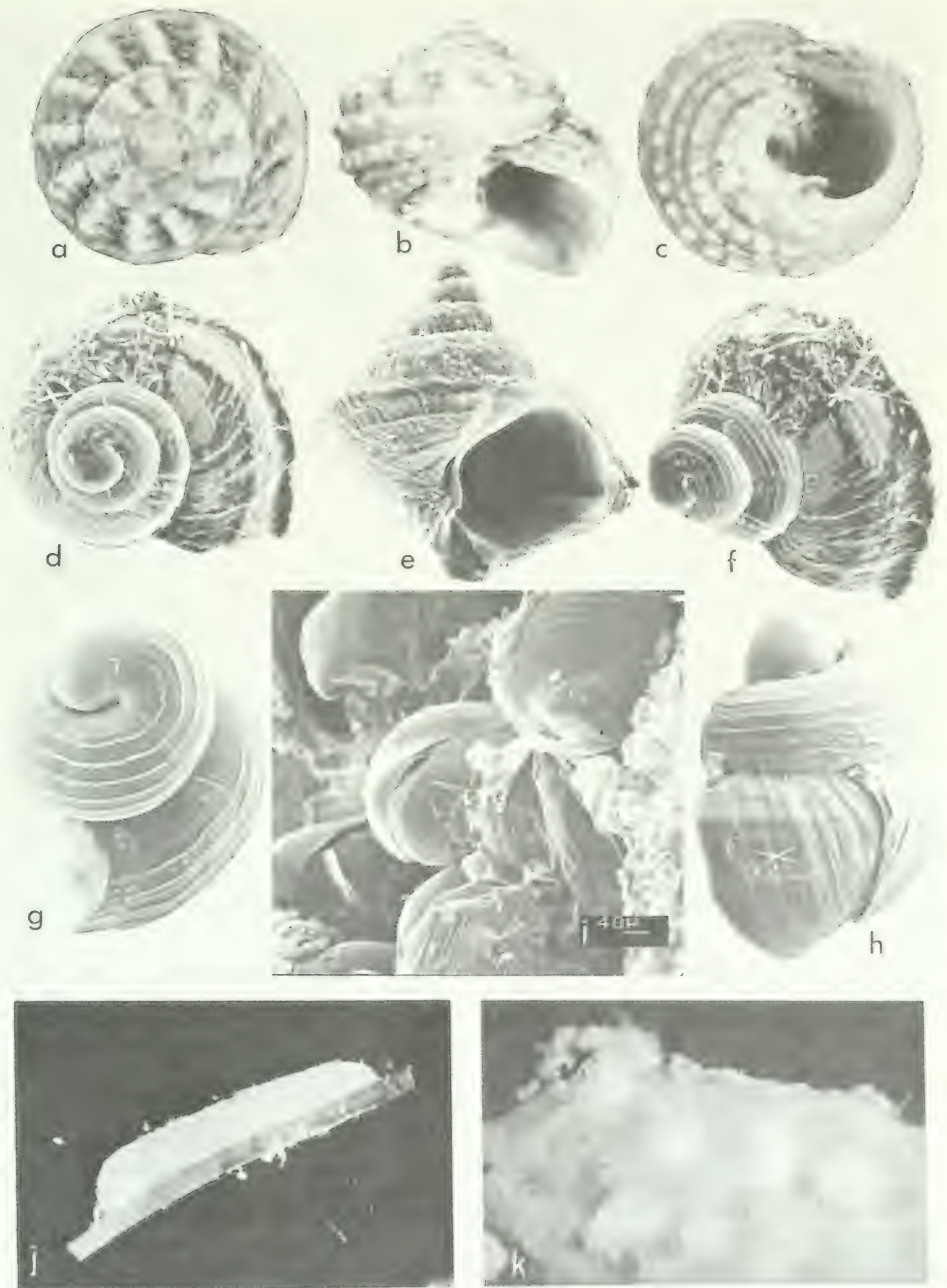

The spire is low and turbinate. The suture is slightly irregular and moderately impressed. The periphery of each whorl has a prominent spiral cord that forms a keel. Three to four weaker spiral cords are above the peripheral cord. Adapical to the peripheral cord each whorl is sculptured with 12–13 axial ribs that form low, blunt nodules where they cross the spiral cords. The body whorl descends just before the aperture in adults and has 4–5 spiral cords on its base sculptured with numerous tiny nodules that are aligned to form weak axial riblets. In juvenile shells the body whorl is extremely angulate and keeled (Fig. 1d–f). The aperture is ovate and the columella deeply concave and terminated with a deep notch or chink that forms a tooth-like lamella. This notch accommodates the pallial tentacles of the inhalant siphon. The outer lip is moderately thin and strongly crenulate, each scallop fitting a pallial tentacle. The inner surface of the outer lip is reinforced with 5–6 spiral ridges. The umbilicus is small but deep and in adults is slightly covered by the columellar fold. The protoconch consists of two whorls that are convex but not angulate, and sculptured with 5–6 thin, spiral lirae except for the smooth nuclear tip. Basic shell color is a dirty white but is normally hidden by the periostracum and algal epiphytes. Brownish purple splotches occur on the spiral chords and adjacent to the suture of the body whorl. The columella is tinged with purple and the columellar notch has a purple spot. Average shell dimensions of the Link Port population were 8.31 mm in length and 9.24 mm in width (see Table 1). The operculum is thin, corneous, circular and multispiral with a central nucleus. It fits snugly into the aperture of the shell when the animal is retracted. The periostracum is thin, and tan.

*Animal: external features* (Fig. 2).—The base color of the head, neck and foot regions

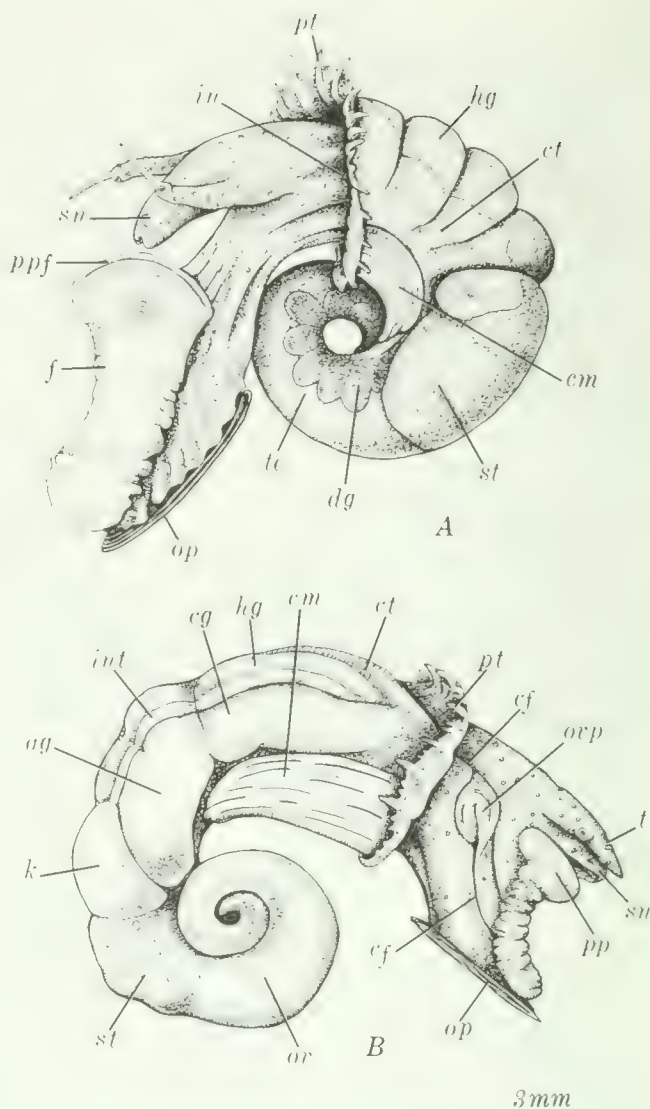

FIG. 2. A, *Modulus modulus*, male removed from shell and viewed from left side. B, Female removed from shell and seen from right side. ag, albumen gland; cf, ciliated furrow; cg, capsule gland; cm, columellar muscle; ct, ctenidium; dg, digestive gland; f, foot; hg, hypobranchial gland; in, inhalant siphon; int, intestine; k, kidney; mt, mantle tentacle; op, operculum; ov, ovary; ovp, ovipositor; pp, propodium; ppf, propodial furrow; pt, pallial tentacle; sn, snout; st, stomach; t, tentacle; te, testis.

TABLE 1. Analysis of shell dimensions (measurements in mm).

Statistic	No.	%	Length			Width		
			$\bar{x}$	Sd	Range	$\bar{x}$	Sd	Range
All shells	61	100	8.31	0.63	6.3–10.1	9.24	0.66	7.7–10.6
Males	27	44.26	8.24	0.78	6.3–10.1	9.09	0.67	7.7–10.6
Females	32	52.46	8.40	0.47	7.5–9.5	9.94	0.64	9.2–10.5
Parasitized	2	3.27	—	—	—	—	—	—

No., number of snails  
Sd, standard deviation  
 $\bar{x}$ , mean

is pinkish-cream with dusky green and chalky white blotches, spotted with tiny red flecks. The white blotches are composed of fine white dots. Some yellow pigment occurs on the proximal portion of the dorsal surface of the neck and body. The base of the foot is more lightly pigmented. The overall appearance is a light green or mossy green color, as described by Abbott (1944: 3).

When fully extended the foot is slightly smaller than the diameter of the shell. The foot is shield-shaped and begins with a crescent-like propodium that has a deep glandular furrow (Fig. 2A, *ppf*) set off anteriorly with a pigmented band of alternating green and white bars and posteriorly with a thin, lightly pigmented area. This furrow is formed by an invagination of numerous, highly vacuolated, glandular cells. Although the muscles of the sole produce monotaxic retrograde waves, the animal moves by jerk-like contractions of the columellar muscle.

The head has a short, rounded, dorso-ventrally flattened snout with a bilobed tip bearing a longitudinal slit leading to the mouth (Fig. 1A, *sn*). The dorsal surface of the snout is dark brownish-green and the tip is bordered with alternating white and green blotches and randomly placed red dots. The ventral surface is pinkish. The snout can be extended considerably when the animal is seeking to right itself but is normally held in a retracted state, even while feeding.

The head has two thin tentacles (Fig. 1B, *t*), about 3 mm in length, in an average-sized animal. The tentacles and head are covered with tiny prominent white pustules. The proximal two thirds of each tentacle is thicker than the tip. When crawling, the tentacles are placed at 45 degrees to the snout and the thin tips are placed on the substratum where they probably serve a sensory function. The eyes are placed on the tentacles where they narrow, about two thirds the way from the base. Eyes are black and surrounded by a narrow circle of deep yellow pigment. There is a dark horizontal green band of pigment adjacent to each eye. Animals respond quickly to a shadow or sudden movement.

The dorsal half of the mantle edge is scalloped and fringed with about 20 thick, white pallial tentacles (Fig. 3D), each having two tiny pink dots on its medial ventral surface. Between each pallial tentacle is a dark green blotch. The mantle edge, as seen in cross section, is trilobed (Fig. 3C). There is a deep ciliated furrow between the lobes. This furrow

prevents foreign matter from getting between the shell and mantle by collecting debris which is then moved down the right side of the mantle edge and expelled by the exhalant siphon. The outer lobe, adjacent to the shell, is transparent, microscopically scalloped and has a slight groove at its tip. The inner edge bears the pallial tentacles and is brightly pigmented. The inhalant and exhalant siphonal portions of the mantle edge are thicker and slightly curved but have no distinguishing morphological characteristics. The ventral half of the mantle edge lacks the lobes and is smooth.

A ciliated furrow (Fig. 2B, *cf*) extends from the exhalant siphonal area down the right side of the foot. It carries fecal pellets and debris entwined in mucus away from the mantle cavity to the bottom of the right side of the foot where they move back under the unattached edge of the operculum and are cast off. The ciliated strip is not readily seen without the application of carmine particles. Marcus & Marcus (1964: 500) described a similar ciliated tract in *Cerithium atratum* (Born, 1778) and I have noted its presence in other cerithiid species. In females, this ciliated strip is a groove that also functions in transporting egg capsules from the distal pallial oviduct to the ovipositor (Fig. 2B, *ovp*) with which it is intimately associated. The ovipositor is a bulbous, swollen area that comprises a thickly furrowed flap under which lies a glandular area of vacuolated cells. It is located midway along the ciliated groove on the right side of the foot and has a distinctive darker color and unusual swollen appearance in ripe females. I did not observe the use of this organ during spawning; consequently, its exact function is unknown. Sections of the organ reveal numerous glandular cells and vesicular elements. Presumably, the ovipositor adds the outer jelly coat that surrounds the egg capsules formed in the pallial oviduct and assists in both the formation of the outer surface and attachment of a completed spawn mass.

Mean length of animals removed from their shells is about 9 mm in their natural coiled state and about 15 mm uncoiled. These mean values are the standards against which other anatomical measurements in this paper should be compared.

The mantle, as seen in snails extracted from shells, is bright orange and green. The portion covering the pallial gonoducts is whitish while that over the intestine and hypobranchial gland is brilliant green. The mantle

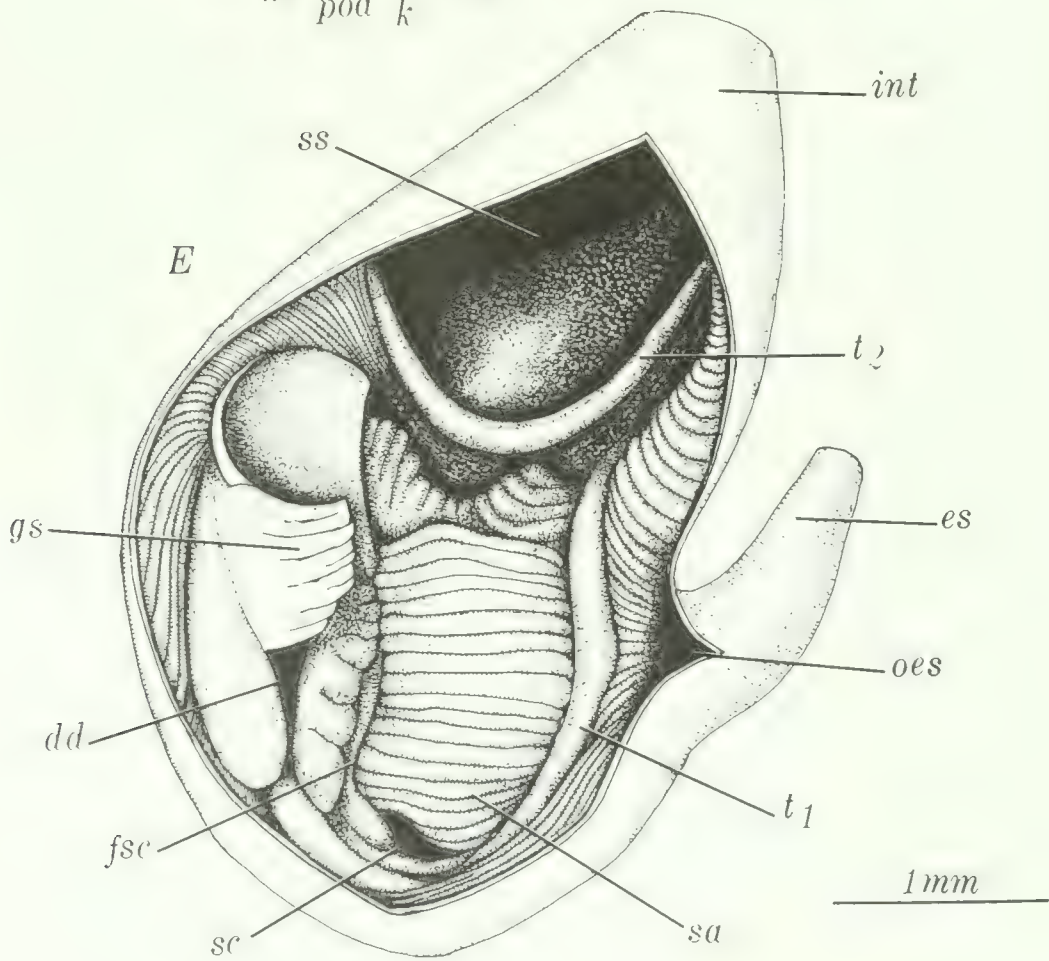
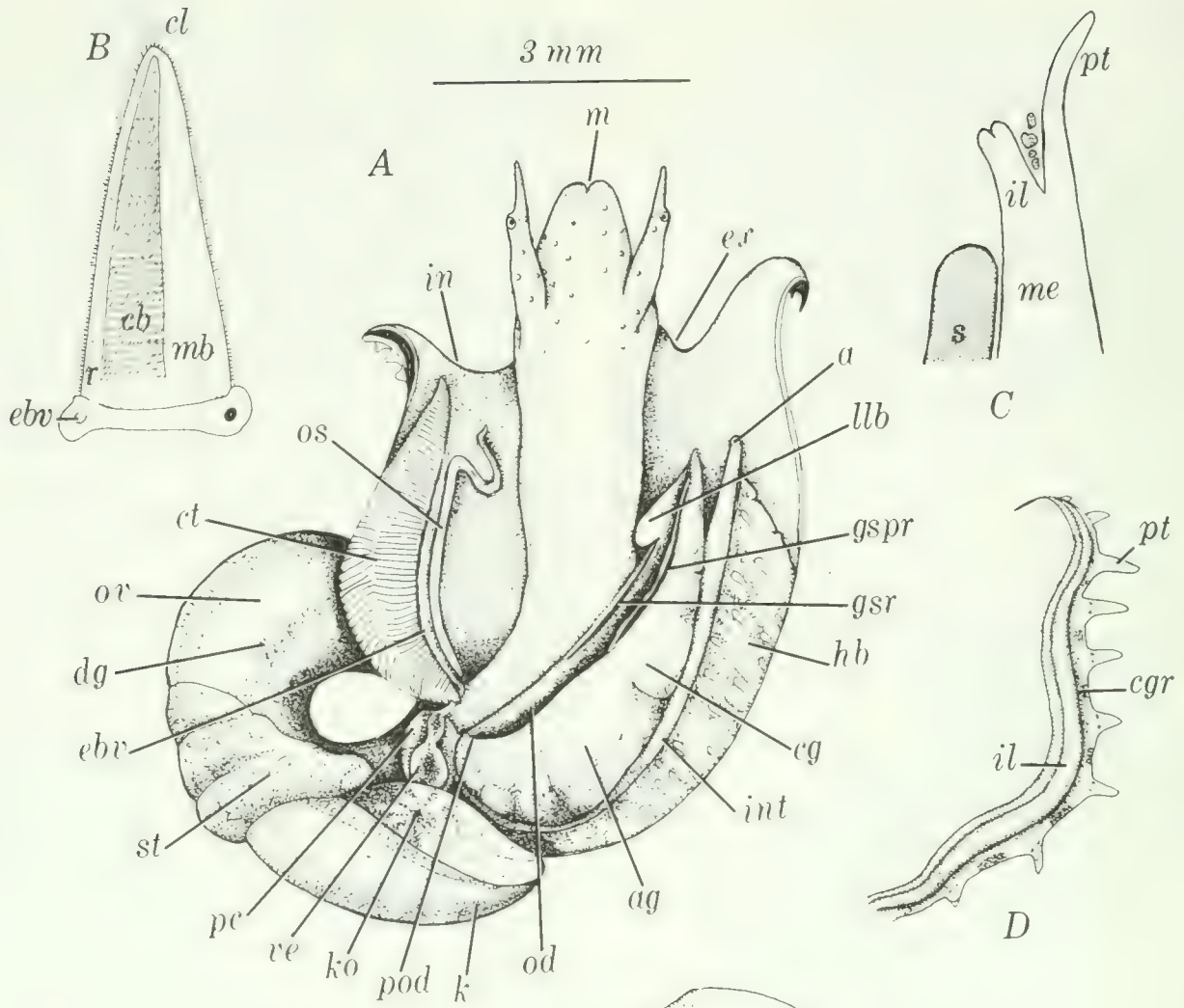

covering the ctenidium and osphradium is orange. The mantle cavity is 5–6 mm deep and is broadest at its distal end where the edge flairs up and backwards. The exhalant siphon is marked on the mantle surface by a prominent, rounded ridge that is thick, muscular and curved in a semicircle down towards the medial right part of the mantle edge.

The columellar muscle (Fig. 2B, *cm*) is broad and quite large (2.5 mm long; 3 mm wide) in relation to the animal. It is tightly attached for one complete whorl to the inner columella of the shell about one-half whorl's distance from the aperture. The columellar muscle is located at the ventral surface of the snail just behind and on the ventral mantle edge where it extends diagonally backwards in relation to the antero-posterior orientation of the mantle cavity. This muscle is powerful in *Modulus* and is used by the animal to retract into the shell and to produce quick jerky movements and violent twisting behavior that will be described in more detail later in this paper.

The whorls of the animal comprising the stomach, gonads and digestive gland taper off sharply and curl beneath the columellar muscle. The stomach (Figs. 2A,B, *st*) occupies about 1.5 whorls and is colored white, brown and green. The remaining two and a half to three whorls comprise the digestive gland and gonad. The digestive gland (Fig. 2A, *dg*) is chocolate brown and is almost entirely overlain by the gonad in ripe animals. The ovary (Fig. 2B, *ov*) is white and extends over the digestive gland in a branching network. The testis (Fig. 2A, *te*) is yellow-orange and covers most of the digestive gland. Since males are aphyllid, the pigmentation of the testis is an easy way to sex ripe individuals. Animals parasitized by trematodes frequently have their gonadal and lower alimentary

tracts filled with rediae, cercariae and sporocysts and have pinkish-colored gonads.

*Mantle cavity and associated organs* (Fig. 3).—At the lower left side of the mantle cavity is the brown-pigmented osphradium (Fig. 3A, *os*), a thin, ridge-like structure that is triangular in cross section and about 5 mm long and 0.35 mm wide. The osphradium begins at the proximal end of the mantle cavity and extends forward, adjacent to the ctenidium for about two-thirds of its length. As the osphradium nears the inhalant siphon it sharply turns to form an "S" shape and tapers to an end about 0.25 mm from the mantle edge. It is separated from the ctenidium by an orange-russet pigmented strip about 0.20 mm wide. Sections of the osphradium show a highly ciliated surface and numerous, darkly staining cells. At its base is a thick osphradial nerve that has connections with the left mantle nerve.

The ctenidium (Fig. 3A, *ct*) is relatively large, about 6 mm in length and 1.5 mm in width. It extends the length of the mantle cavity and comprises about 125 long finger-shaped, flattened filaments. Each filament is 1.5 mm long and 0.45 mm wide at its attached base and tapers toward the tip. Individual filaments are strengthened on the right side (edge) by an internal rod (Fig. 3B, *r*). A ciliated longitudinal band (Fig. 3B, *cb*) is on each side of the flattened surface of a filament, adjacent to the rod. The narrow edges of each filament are lined with cilia and exceptionally lengthy cilia are on the filament tip (Fig. 3B, *cl*). Thin transverse bands of muscles (Fig. 3B, *mb*) allow each filament to respond to the stimulus of a probe by quickly retracting and bending.

The hypobranchial gland (Fig. 3A, *hb*) lies to the right and next to the ctenidium. It is about 4.0 mm long and 1.0 mm wide and highly conspicuous because of its swollen, glandular state and bright russet-green color.

---

FIG. 3. Anatomical features of *Modulus modiolus*. A, Animal removed from shell and mantle cavity opened mid-dorsally. The kidney has been pulled back to expose the kidney opening and heart. B, Individual ctenidial filament. C, Cross section through mantle edge showing trilobed condition and ciliated groove containing debris. D, Dorsal view of mantle edge displaying ciliated groove and inner lobe. E, Stomach opened by dorsal longitudinal cut. Crystalline style has been removed. *a*, anus; *ag*, albumen gland; *cb*, ciliated band; *cg*, capsule gland; *cgr*, ciliated groove; *cl*, long cilia; *ct*, ctenidium; *dd*, digestive gland duct; *dg*, digestive gland; *ebv*, efferent branchial vessel; *es*, esophagus; *ex*, exhalant siphon; *fsc*, fold emerging from spiral caecum; *gs*, gastric shield; *gspr*, groove leading to spermatophore receptacle; *gsr*, groove leading to seminal receptacle; *hb*, hypobranchial gland; *il*, outer lobe of mantle edge; *in*, inhalant siphon; *int*, intestine; *k*, kidney; *ko*, kidney opening; *llb*, baffle of lateral lamina; *m*, mouth; *mb*, muscle band; *me*, mantle edge; *od*, pallial oviduct groove; *oes*, opening from esophagus to stomach; *os*, osphradium; *ov*, ovary; *pc*, pericardial sac; *pod*, proximal portion of pallial oviduct; *pt*, pallial tentacle; *r*, internal strengthening rod; *s*, shell; *sa*, sorting area; *sc*, reduced spiral caecum; *ss*, style sac; *st*, stomach; *t*<sub>1</sub>, typhlosole 1; *t*<sub>2</sub>, typhlosole 2; *ve*, ventricle.

Tapering at both ends, it begins at the proximal end of the mantle cavity and rapidly widens, extending longitudinally and ending behind the anus. The hypobranchial gland lies close to and slightly overlaps the intestine. It is covered externally with numerous tiny papillae and has a transversely ridged surface that is russet colored. Oval and goblet-shaped areas appear within the gland when viewed from the surface. If a snail is violently disturbed or if the hypobranchial gland is stimulated with a probe, it exudes copious strands of tiny, globular, mucus-like bodies. These are shot out in salvos from small openings in the surface of the gland until the mantle cavity is nearly filled with them. The exudate is rapidly moved by cilia and expelled by the exhalant siphon. The animal will continue to exude globular particles whenever stimulated until the gland is spent. The exudate is probably used defensively by the snail when under attack. The composition and nature of the exudate is unknown. I have not seen this phenomenon in other cerithiacean snails. Sections of the hypobranchial gland show numerous columnar, vesicular and darkly stained glandular cells at its surface. Beneath these are vesicle-like chambers that appear to store the hypobranchial exudate. No ducts leading from these chambers to the surface of the gland were seen.

The intestine (Fig. 3A, *int*) is 0.25 mm wide and usually dark colored due to many small, transversely oriented, ovoid fecal pellets that fill it. The pallial epithelium overlying the intestine is covered with tiny papillae that extend over it from the adjacent hypobranchial gland. The anus, borne on a large papilla, is about 2.5 mm from the mantle edge (Fig. 3A, *a*).

The pallial gonoducts are open in both males and females and males are aphyllic. The open condition of the gonoducts is best visualized as a slit tube that runs the length of the mantle cavity, consisting of inner and outer laminae. The male pallial gonoduct (Fig. 8A, *C*) is a thin-walled, glandular, open tube while the pallial oviduct of females (Fig. 8B) is a larger, white glandular organ comprising laminae with complex inner chambers and tiny ducts. The functional aspects of both male and female pallial gonoducts are discussed in detail later in this paper, in the section on the reproductive system.

At the proximal end of the mantle cavity lies the anterior wall of the pericardial sac (Fig. 3A, *pc*) and to its right is the kidney which has

a typical slit-like opening on its ventral surface (Fig. 3A, *ko*).

*Alimentary system* (Figs. 3A, 4, 5).—This system is typically mesogastropodan and is somewhat like that described by Fretter & Graham (1962: 25–32) for *Littorina*. The mouth lies at the tip of the snout but is usually recessed between the two lobes that comprise the snout apex. At the anterior end of the buccal cavity and inserted in its lateral walls are a pair of chitinous jaws (Fig. 4, *j*) composed of tiny rhomboidal plates. Dissection of the buccal apparatus reveals two large radular retractor muscles that arise from the walls of the anterior body cavity and insert on the post-median surface of the buccal mass (Fig. 4, *lrm*, *rrm*).

The buccal mass (Fig. 4, *bm*) is about 1.65 mm long and 1.24 mm wide. The radular ribbon is 2.25 mm long and 0.35 mm wide, comprises about 68 rows of teeth, and is one-fourth the length of the shell (see Table 2). It is typically taenioglossate (2+1+1+1+2) and has a rounded, quadrate-shaped rachidian tooth (Fig. 5). The basal plate of the rachidian is smooth and has a long central projection and convex lateral sides. It is similar to that of *Cerithium* species and lacks the basal cusps that are seen on potamidid species such as *Batillaria*. The top of the rachidian tooth is markedly convex and has a cutting edge comprised of a large, pointed central denticle that is flanked on each side with 2–3 smaller pointed denticles that diminish in size laterally. The lateral tooth of the radula is trapezoidal in shape, and has a long lateral extension that curves down at its insertion point in the radular membrane. On the basal plate of the lateral tooth there is a long, blunt longitudinal extension. The top of the lateral tooth is straight and serrated with a small inner cusp, a second larger cusp and 3–4 smaller ones. The inner and outer marginal teeth are long, spatulate and serrated at their tips with 5–6 closely set, blunt denticles. The two marginal teeth are virtually identical, and thus differ from those of *Cerithium* species, which have distinguishable outer and inner marginal teeth. The radular sac begins ventral to the esophagus and coils in a spiral to the right. There are no esophageal pouches. A large spade-shaped esophageal valve is present.

The paired salivary glands (Fig. 4, *lsg*, *rsg*) are loosely compacted lobes, lying behind the buccal mass above and beside the anterior esophagus. The left is four-lobed, and twice as large as the right, and extends through the

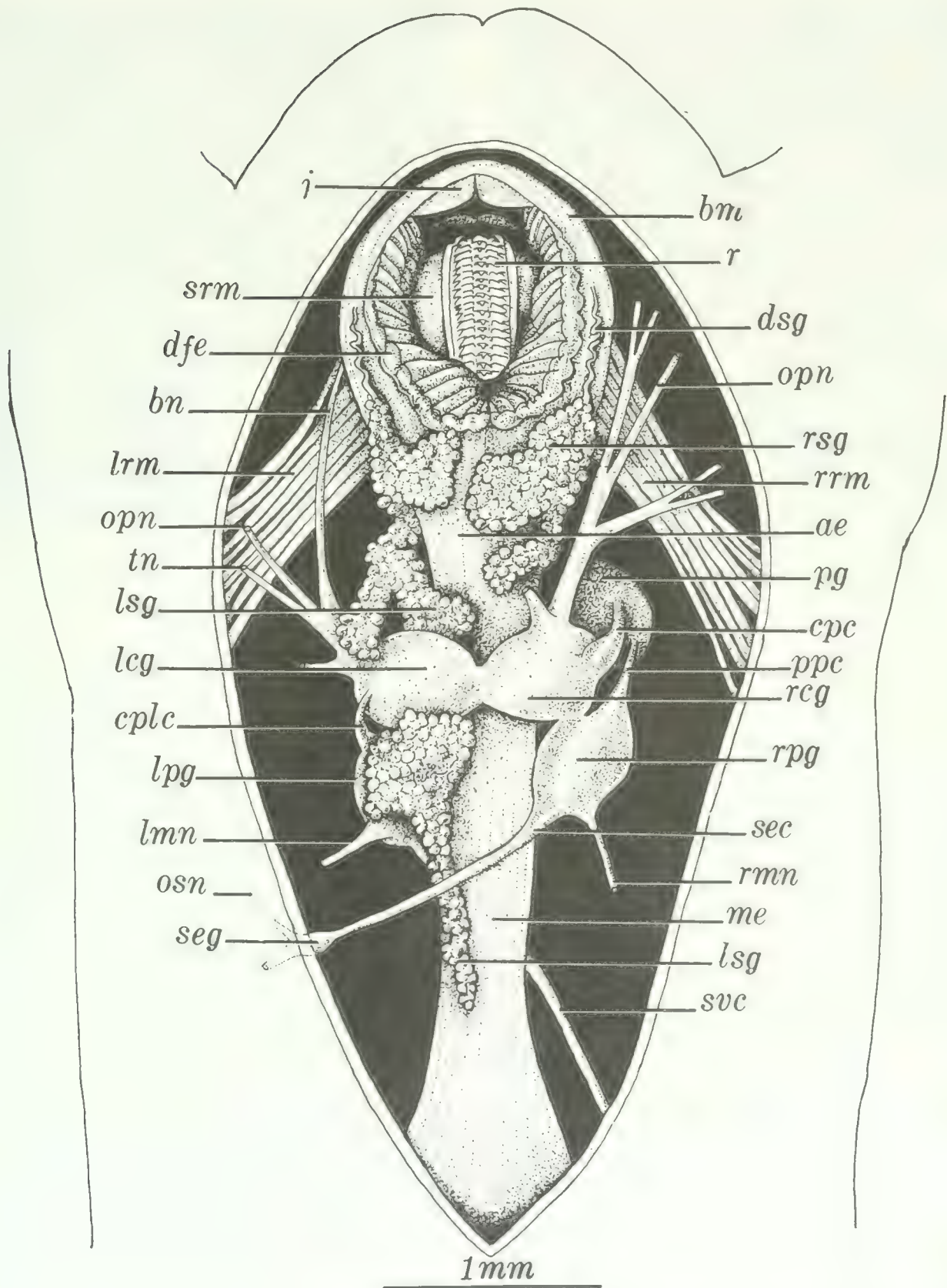

FIG. 4. Dissection of the head of *Modulus modulus* opened by a dorsal longitudinal cut exposing anterior alimentary tract. *ae*, anterior esophagus; *bm*, buccal mass; *bn*, buccal nerve; *cpc*, cerebral-pedal connective; *cplc*, cerebral-pleural connective; *dfe*, dorsal fold of esophagus; *dsg*, duct of right salivary gland; *j*, jaw; *lsg*, left cerebral ganglion; *lmn*, left mantle nerve; *lpg*, left pleural ganglion; *lrm*, left radular retractor muscle; *lsg*, left salivary gland; *me*, mid-esophagus; *opn*, optic nerve; *osn*, osphradial nerve; *pg*, right pedal ganglion; *ppc*, pleural-pedal connective; *r*, radula; *rcg*, right cerebral ganglion; *rmn*, right mantle nerve; *rpg*, right pleural ganglion; *rrm*, right radular retractor muscle; *rsg*, right salivary gland; *sec*, supraesophageal connective; *seg*, supraesophageal ganglion; *srm*, subradular membrane; *svc*, subvisceral connective; *tn*, tentacle nerve.



FIG. 5. Radula of *Modulus modulus*. Left, general view of radular ribbon; right, half row showing cusp arrangement on rachidian, lateral and marginal teeth. Rachidian tooth length = 0.06 mm.

TABLE 2. Statistical summary of radular and shell measurements.

Statistic	No.	$\bar{x}$	Sd	Range
Shell length	8	8.75	0.37	8.1– 9.2
Shell width	8	9.75	0.49	9.1–10.2
Radula length	8	2.21	0.17	2.0– 2.5
Rows of teeth	8	68.8	2.60	66 –73

No., number of snails

Sd, standard deviation

$\bar{x}$ , mean

nerve ring a short way down the mid-esophagus. The right gland is three lobed, and lies wholly in front of the nerve ring. The ducts arise in front of the cerebral ganglia, and enter the buccal cavity at each side (Fig. 4, *dsg*).

The anterior esophagus has a pronounced dorsal food groove, and twists, due to torsion, at the cerebral ganglia; but the dorsal folds do not extend back ventrally as in *Littorina*. The dark-pigmented mid-esophagus can be seen through the dorsal body wall. It is enlarged into a well developed esophageal gland comprising numerous deep folds and diverticula, giving it a loosely compacted flocculent structure that easily falls apart under dissection. Beginning behind the nerve ring, it tapers rapidly, like the mid-esophagus itself towards the rear of the mantle region. The posterior esophagus is also dark-pigmented, and has 4–6 longitudinal ridges. It opens into the stomach shortly behind the mantle cavity.

The stomach (Fig. 3E) is about 4 mm long, occupies about two-thirds of a whorl, and is typically cerithioid in layout. Topographically, it is not unlike that depicted for *Turritella* by Graham (1938). It has a short, wide style sac and a well-formed crystalline style. If the stomach is opened by a dorsal longitudinal cut, the esophagus is seen to enter at its right anterior end. An opening to the digestive gland (Fig. 3E, *dd*) and what appears to be a much reduced spiral caecum (Fig. 3E, *sc*) are both near the esophageal opening. A broad sorting area (Fig. 3E, *sa*) is in the ventral portion of the stomach. A thick cuticular gastric shield (Fig. 3E, *gs*) lies to the left, directly across from the anterior opening of the intestine and style sac. The crystalline style is present in all freshly collected specimens and is a short, transparent dumb-bell shaped rod about 2.8 mm in length. The style sac (Fig. 3E, *ss*) from which it emerges, although joined to the intestine, is a separate structure with a blind end. The major typhlosole (Fig. 3E, *t*<sub>1</sub>) emerges from the intestinal groove and curves around to the spiral caecum. A small minor typhlosole (Fig. 3E, *t*<sub>2</sub>) runs from the sorting area into the intestine.

The intestine leaves the stomach at the left anterior end of the style sac region and coils back over the style sac before turning anteriorly where it enters the mantle cavity. The portion of the intestine that exits from the stomach has a large dorsal typhlosole that is



gradually lost as the intestine nears the mantle cavity where it has a smooth interior. It becomes ridged and more glandular in the mantle skirt.

*Reproductive system* (Fig. 8).—Open pallial gonoducts in both sexes, the lack of a penis in males and the formation of spermatophores by males are fundamental features of the reproductive system in *Modulus modulus*. The basic groundplan of the pallial gonoducts in *Modulus* is the same as in other cerithiaceans such as *Cerithium*, *Bittium*, *Rhinoclavis* and *Batillaria* but differs in the placement and arrangement of internal ducts and seminal receptacles in the laminae of the gonoduct. The pallial gonoduct is best visualized as a tube-like duct, extending from the proximal end of the mantle cavity to the mantle edge, and slit open along its longitudinal axis. In both sexes the pallial gonoduct comprises lateral (right) and medial (left) laminae that are fused dorsally to each other and to the lateral mantle wall. The ventral margins of the laminae are free and open to the mantle cavity. In *Modulus* both laminae have internal ducts and pouches used for the reception, transmission and storage of spermatophores and spermatozoa.

*Male reproductive tract* (Fig. 8).—In males the laminae of the gonoducts are white, thin-walled structures (Fig. 8). The medial (left) lamina is membranous and semi-opaque and its inner surface has numerous, transversely oriented ridges. Near the axis of attachment there are wider, denser and less numerous ridges. The lateral (right) lamina (Fig. 8A, //) is fused along its axis to the mantle and partially on its left side to the epidermis of the visceral hump. It is opaque and thick and its inner surface has thick convoluted ridges. The male pallial gonoduct is slightly closed at its proximal end due to the medial lamina folding over the posterior portion of the lateral lamina (Fig. 8A, *pmg*). This creates a closed pouch filled with numerous glandular axial ridges. This area of the gonoduct is probably the prostate gland (Fig. 8C, *pg*). Distal to the closed portion of the gonoduct is a thicker longitudinal glandular ridge and several wide axial glandular folds that stain darkly with Methylene Blue. Adjacent to these folds are numerous smaller axial folds. This glandular area of the inner surface of the lateral lamina extends to the distal end of the gonoduct and is probably the spermatophore organ. Its exact mode of functioning is unknown. I have not seen a developing or a completed spermatophore in the

male gonoduct nor the method of transfer to the female, but it probably occurs via siphonal currents as I have described in *Cerithium muscarum* (Houbrick, 1973). In the aquarium I saw some spermatophores pass out the exhalant siphon of a male and fall to the bottom.

The bright orange testis lies on the outer dorsal surface of the digestive gland. The seminiferous tubules empty into a branching network of microscopic ducts that lead to about 10 vasa efferentia. These empty into the vas deferens that lies on the inside of the visceral coil and appears as a white duct that in ripe males is packed with eupyrene and apyrene sperm.

SEM preparations of spermatozoa reveal that a eupyrene spermatozoon (Fig. 6, *f*) is about 36  $\mu\text{m}$  in length, has a pointed acrosome, a short, cylindrical, thick head and constricted neck region, and a long midpiece about one-fifth the length of the spermatozoon. A long narrow flagellum follows the midpiece. Eupyrene spermatozoa taken from the vas deferens are attached by their acrosomes in small clusters.

Apyrene spermatozoa (Fig. 6a, *g*) are larger, about 48  $\mu\text{m}$  in length, bear six flagella, have a spiral configuration, and very long pointed heads almost one-half the length of a sperm. It is not clear if there is a midpiece; consequently, this long head region may consist of head and midpiece. Although no counts were made, there appears to be an equal number of both kinds of sperms, tangled together by the numerous flagella into dense masses. Thus the apyrene spermatozoa may serve to bind the mass together with their flagella. Apyrene sperm move in a slow sinuous manner while eupyrene sperm are fast moving.

The spermatophores of *Modulus* are immobile, thinly walled, acellular structures of 1–3 mm length. Fresh spermatophores are white, shiny, crescent-shaped and swollen with spermatozoa. One end is round and pointed and the other more flattened and bifurcate (Figs. 6, 7a–b). A prominent keel extends axially along one side of the spermatophore (Fig. 6a). The pointed end (Fig. 7c), when lodged in the female gonoduct, lies closest to its proximal end. If pressure is applied to a fresh spermatophore, sperm emerge from the lower branch of the bifurcated end, where there appears to be a tube-like exit (Fig. 7b). Equal numbers of eupyrene and apyrene spermatozoa are contained in the spermatophore.

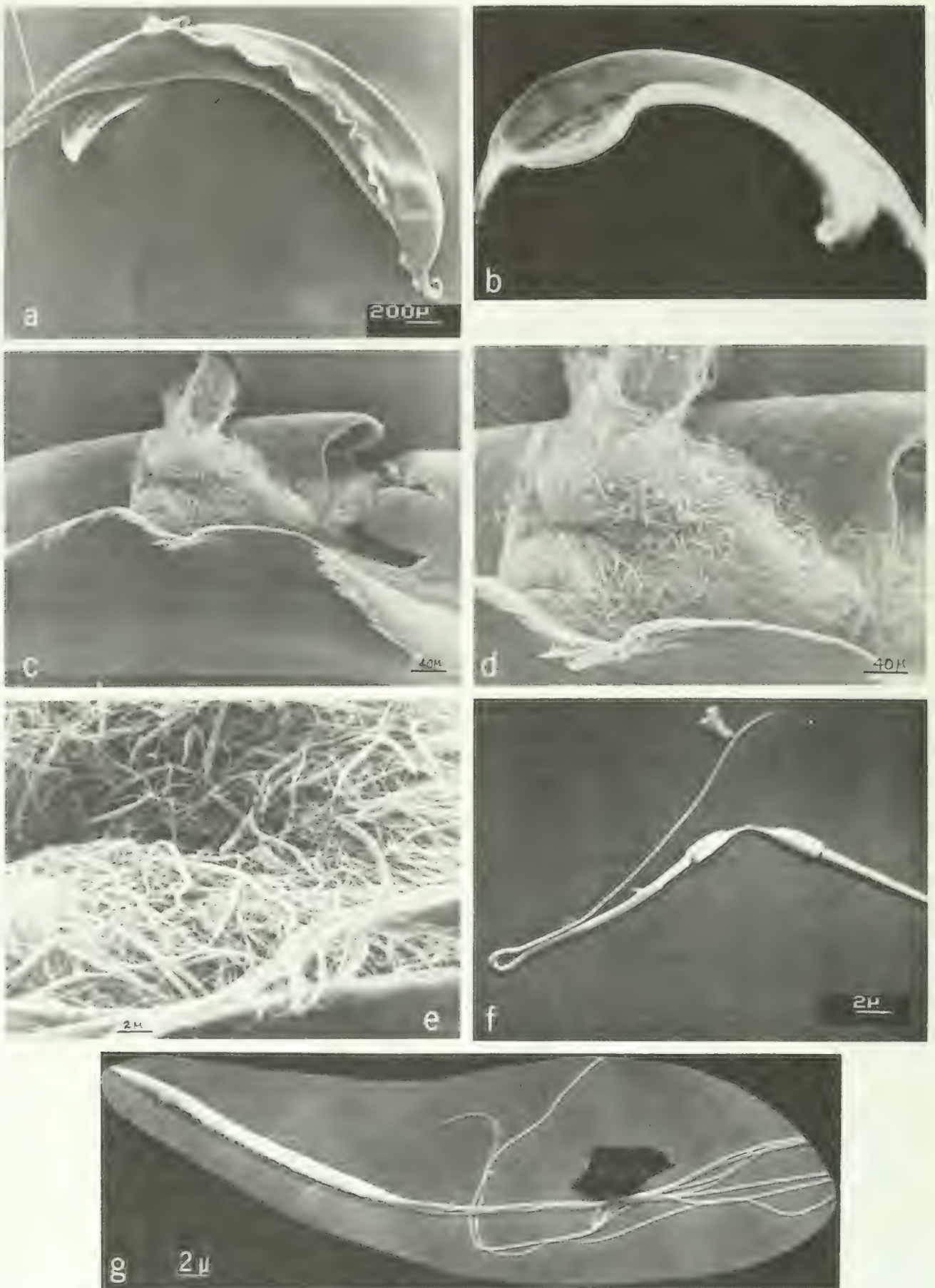

FIG. 6. Spermatophore and sperm of *Modulus modulus*. SEM micrographs: **a**, Spermatophore, critical point dried and partially collapsed. Note distinctive axial keel; **b**, Spent spermatophore, freshly extracted from spermatophore receptacle, showing remaining sperm at bifurcate end; **c-e**, Details of torn portion of critical point dried spermatophore (as seen in Fig. 6a) showing densely packed sperm; **f**, Eupyrene sperm attached by acrosomes and showing long mid portion; **g**, Apyrene sperm demonstrating multiflagellate condition and spiral configuration of mid head piece.

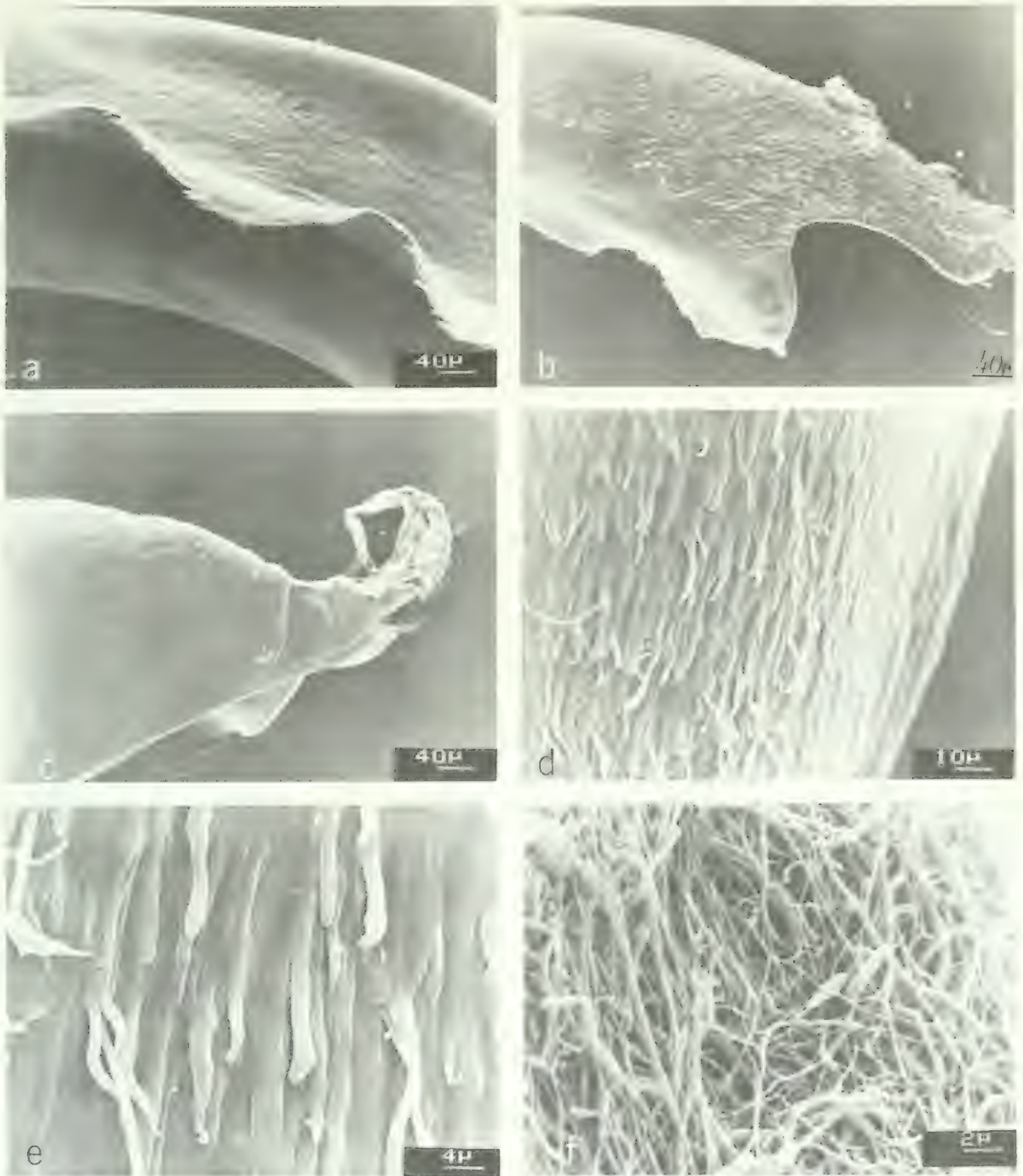

FIG. 7. Spermatophore of *Modulus modulus* showing details of keel (a), bifurcate end (b), round pointed end (c), and acellular fibrous matrix comprising surface structure (d–e); f, Eupyrene and apyrene sperm extracted from seminal receptacle of female.

SEM preparations of critical point dried spermatophores reveal a complex surface structure (Fig. 7a–e). Spermatophores are composed of long, axially oriented string-like fibers embedded in a matrix (Fig. 7d–e). At the pointed end the fibrous matrix is closely bound together and the external surface is relatively smooth. In the bifurcate part, the

ends of individual fibers are free, creating a shaggy appearance (Fig. 7b). The edge of the keel is serrated due to free fiber ends that point away from the pointed tip. SEM pictures of a fractured spermatophore wall show that it is about  $5\ \mu\text{m}$  thick and composed of three layers: an outer fibrous layer, a thick middle layer filled with spongy-looking globules of

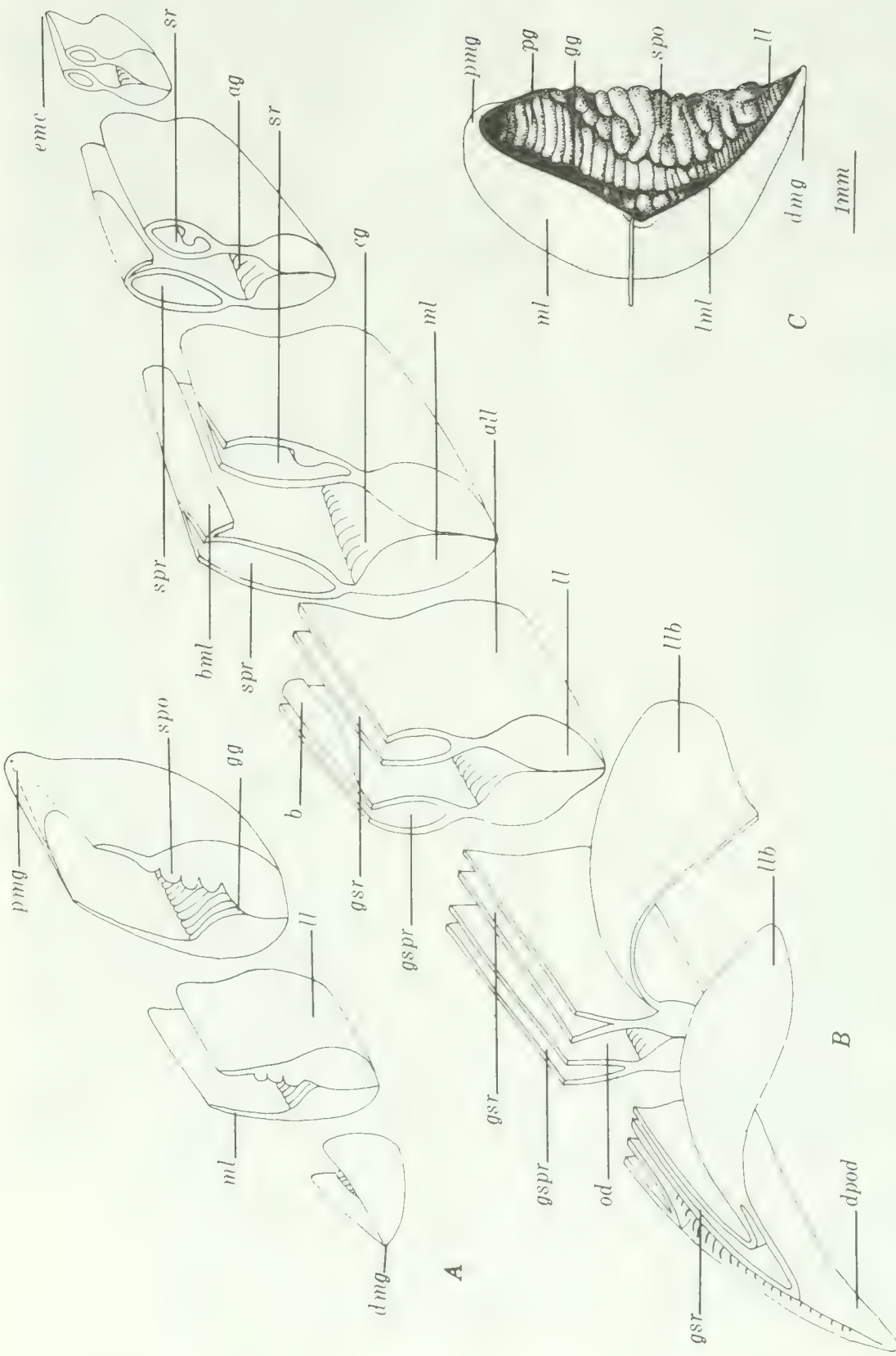

FIG. 8. Pallial gonoducts of *Modiolus modiolus*. A, Schematic representation of male pallial gonoduct viewed from left with columellar muscle removed (compare with C). B, Schematic representation of female pallial oviduct viewed from left with columellar muscle removed. C, Male pallial gonoduct with medial lamina pulled back exposing glandular interior (compare with A). ag, albumen gland; all, attached surface of lateral lamina; bml, baffle of medial lamina; cg, capsule gland; dmeg, distal portion of female pallial gonoduct; dpod, distal portion of female pallial oviduct; emc, end of mantle cavity; gg, gonoduct groove; gspr, groove leading to spermatophore receptacle; gsr, main passage; ll, lateral lamina; llb, baffle of lateral lamina; lmm, lip of medial lamina; ml, medial lamina; pmg, prostate gland; pg, prostatic gland; spo, proximal part of male gonoduct; spo, spermatophore organ; spr, spermatophore receptacle; sr, seminal receptacle.

unknown composition, and a thin inner fibrous layer.

*Female reproductive tract* (Figs. 3, 8).—The pallial oviduct is an opaque, cream-colored organ about 5.5 mm long and differs from the male gonoduct by its larger size and longer, swollen laminae. The bases of the laminae stain darkly in sections and are highly glandular. The medial (left) lamina (Fig. 8B, *ml*) has a thick lower portion composed of transversely oriented glandular folds adjacent to the line of axial fusion to the mantle. There is a construction in the medial lamina, about half-way to its outer edge, separating the lower swollen, glandular part from the upper, more membranous part. An open slit in the upper portion of the lamina begins at the distal end and becomes a ciliated gutter (Fig. 8B, *gspr*). The highly ciliated gutter gets deeper and becomes a large, closed, internally ciliated tube-like pouch occupying the proximal third of the medial lamina. Both the ciliated gutter and pouch comprise the spermatophore receptacle (Fig. 8B, *spr*) which is probably homologous to the "bursa copulatrix" or sperm-collecting pouch in *Cerithium* and *Rhinoclavis* (Houbriek, 1974a; 1978). Sections show that the inner walls of the receptacle consist of columnar epithelial cells with darker staining glandular cells.

Spermatophores are drawn by ciliary currents into the mantle and enter the spermatophore receptacle pointed end first. An individual spermatophore fills the entire length of the spermatophore receptacle, its bifurcated end sticking out at the distal end. Both the serrated edge of the spermatophore keel and the minute free fibrous ends of its surface help to anchor it in the receptacle. An individual spermatophore receptacle normally holds one spermatophore but occasionally two may be found.

Sperm emerge from the lower, bifurcate end of the spermatophore and move into another ciliated groove formed by a fold arising from a baffle on the middle part of the free edge of the medial lamina. This forms a long, deep, highly ciliated slit with an open edge facing and slightly overhanging the free edge of the lateral lamina. Sperm leaving the spermatophore are probably transferred by this ciliated groove to the ciliated gutter (Fig. 8B, *gsr*) of the lateral lamina leading to the seminal receptacle in the upper portion of the lateral lamina (Fig. 8B, *sr*). Spermatophores slowly dissolve within the spermatophore receptacle and may be recovered in various stages of disintegration.

The lateral lamina (Fig. 8B) has the same layout as the medial lamina: i.e., a thick glandular, attached axial base separated from the upper membranous, free part of the lamina by an axial constriction. The upper membranous part of the lateral lamina also has the same groundplan as the membranous part of the medial lamina, but is mostly fused to the columellar muscle. Not far from the distal end of the lateral lamina, an open slit develops into a long ciliated gutter (Fig. 8B, *gsr*), that proximally becomes a closed pouch. This pouch is the seminal receptacle (Fig. 8B, *sr*) and is distended with sperm during the reproductive season, when its inner walls are glandular and villous.

The morphology of the gutter and seminal receptacle of the upper lateral lamina is complicated by an involution and doubling back of the upper lateral, membranous wall of the ciliated gutter. This involution in the wall of the gutter assumes the form of a large flap of tissue (Fig. 8B), covering the top of the open slit and gutter at the upper part of the distal third of the gonoduct. The flap probably serves as a baffle which may prevent spermatophores from entering the seminal receptacle instead of the spermatophore receptacle. It may also guide released sperm into the seminal receptacle.

The thick, lower, inner portions of both laminae form the albumen gland and the capsule gland. The albumen gland (Fig. 8B, *ag*) is located in the proximal part of the axial base of the oviduct. The capsule gland (Fig. 8B, *cg*) is a loosely compacted darkly staining area located in the middle portion of the lateral lamina.

The pale green ovary consists of numerous, tiny, compact lobes. A thin-walled ovarian duct, about 0.4 mm wide, extends from the ovary and runs forward along the ventral side of the viscera where it passes under part of the kidney and lies adjacent to the intestine and pericardial cavity before entering the mantle cavity. Oocytes from the ovarian duct are about 0.15 mm in diameter.

*Nervous system* (Fig. 4).—The nervous system is similar to that of *Cerithium* and *Rhinoclavis* and is typically cerithioid. It is not as highly condensed as in other mesogastropods such as the rissoaceans. If one uses the "RPG" ratio of Davis et al. (1976: 263) (length of the pleurosopraesophageal connective divided by the sum of the lengths of the right pleural ganglion) to determine the state of condensation, a mean value of 0.59 is obtained which is a little above an intermediate

TABLE 3. The RPG ratio for *Modulus modulus*. This ratio is the length of the pleuro-esophageal connective divided by the sum of the lengths of the supra-esophageal ganglion, pleuro-supraesophageal connective and right pleural ganglion.

No.	$\bar{x}$	Sd	Range
7	0.59	5.21	0.54–0.70

No., number of snails  
Sd, standard deviation  
 $\bar{x}$ , mean

value (Table 3). As Davis pointed out, the higher the value the "looser" and more primitive is the nervous system. Distinctive characters are the lightly pigmented cerebral, pleural and pedal ganglia which are covered with tiny dots of tan color. The origin of the tentacular nerve is also lightly pigmented and is slightly swollen. The cerebral ganglia are moderately fused to the pleural ganglia and have virtually no connectives (Fig. 4, *rcg*, *rpg*, *lpg*, *lpg*). The cerebral-pedal connective is also short, about 0.25 mm long. The pedal ganglia are large, about 0.50 mm in length and deeply embedded in the muscle of the foot. The cerebral ganglia are of equal size (0.50 mm) and joined by a very short commissure. The pleural ganglia are slightly smaller, each about 0.40 mm long. A schematic representation of the ganglia and their relationship to other organs of the head are shown in Fig. 4.

*Circulatory and excretory systems.*—There is nothing particularly distinctive about either of these systems in *Modulus*. Both kidney and heart are typically monotocardian and not unlike those of *Littorina*, described in detail by Fretter & Graham (1962: 34–35). It is noteworthy that the anterior aorta is very wide as it passes over the mid-esophagus.

## REPRODUCTIVE BIOLOGY

The percentages of males and of females and statistics relevant to their shell measurements are presented in Table 1. Females are more numerous than males. Gametes have been described in detail in the sections on the reproductive tract. Most reproductive activity takes place from late winter through spring (February through May).

*Pairing.*—Males become ripe in mid-winter and produce spermatophores from January through May. Females begin spawning in the spring. In May, pairing of males and females

is frequent. The male's foot is attached to the female's shell so that the two edges of their mantle cavities are adjacent. Spermatophores leave the mantle cavity of males by the exhalant siphon and presumably enter the female's mantle cavity via her inhalant siphon because males lack a penis or other organ of intromission. Not all spermatophores are successfully introduced: some drop to the bottom of the aquarium. The same phenomenon was seen in *Cerithium muscarum* (Houbrick, 1973) and may be due to artificial lab conditions. Spermatophores in the female's mantle cavity are moved by ciliary currents over the head-foot into the open ciliated gutter and spermatophore receptacle in the medial lamina of the pallial oviduct. The flap on the distal part of the lateral lamina and the second ciliated gutter of the medial lamina overhanging the lateral lamina probably prevent premature entry of the spermatophore into the seminal receptacle.

*Spawn.*—Deposition of spawn was first seen in May, although spawning may have occurred in March and April when I was away from the study site. Spawn is deposited on grassy blades of marine angiosperms, such as *Halodule*, in worm-like gelatinous tubes about 14.10 mm in length, and 2.13 mm in width (Fig. 1j–k). Each spawn mass contains an average of 121 eggs. Within the gelatinous tubes fertilized eggs are enclosed in hyaline capsules of 0.50 mm diameter, each capsule containing a single egg, 0.15 mm in diameter (Fig. 1i, k). Although a few eggs contain teratological embryos, there are no nurse eggs. Table 4 presents more statistics about egg masses.

Individual spawn masses are cylindrical except for a narrow, flattened surface at the point of attachment to a grass blade. They are axially attached to grass blades (Fig. 1j) but occasionally curve or have a spiral configuration. The tough parchment-like outer wall of a spawn mass is frequently covered with fine sand grains and detrital particles, making it

TABLE 4. Statistical summary of spawn mass dimensions and of embryos per spawn mass.

Statistic (n = 8)	$\bar{x}$	Sd	Range
Length (mm)	14.1	5.05	9.3– 24.2
Width (mm)	2.13	0.26	1.8– 2.5
No. of embryos	121	43.33	70 –169

$\bar{x}$ , mean  
Sd, standard deviation

somewhat opaque. Internally, a spawn mass is viscous and comprises a matrix of spiral, gelatinous strands that contain tear-shaped, jelly-filled compartments each of which holds an egg capsule. In cross section, the entire spawn mass appears to be two gelatinous strands thick. There is no internal cavity evident.

Spawn masses are deposited in vast numbers in the grass beds at Link Port. There is an average of 360 spawn masses, comprising 43,560 embryos, per square meter of grass bed.

*Development.*—Only a brief descriptive account of the developmental process is presented below because a more detailed study was beyond the scope of this research.

Development of *Modulus modulus* is direct. Each spawn mass contains capsules with embryos in various stages of development. That portion of the spawn first deposited by the female has more advanced embryos than the latter part, which may contain capsules having embryos in early cleavage stages. Thus, within a single spawn mass one may find fertilized eggs, early cleavage stages, blastula and gastrula stages and early veliger embryos, progressively arranged from one end to the other. Fertilized eggs and early cleavage stages are the same pale green color as eggs that emerge from the oviduct. Freshly laid spawn may be easily identified by the pale green embryos whereas older spawn masses lack this color. Embryos become light tan when they attain the mid-veliger stage.

To study development, newly deposited spawn masses, laid on the evening of May 9, 1978 were placed in petri dishes with sea water and the growth of embryos from the first portion of each spawn mass was monitored until they hatched from their capsules.

Early cleavage stages are about one-fourth the diameter of the egg capsule. As embryos develop into blastulas and gastrulas they become larger and continue to grow throughout the veliger and hatching stages until the embryonic shell occupies the entire capsule (Fig. 1j). Capsule diameter remains constant throughout all developmental stages.

Cleavage is rapid; the 8-cell stage was attained within 3 hours after deposition. Blastula and gastrula stages were attained on May 10 and May 11. By May 12, a shell gland and prototroch were present, indicating the beginning of the veliger stage. On May 15 early veliger stage embryos with cap-like protoconchs, ornamented with the beginnings of a

distinctive spiral sculpture, were present. A large, yolky digestive "anlage" was also present as well as the early pedal structure. Although early velar lobes were present, no stomodaeum was seen. Embryos at this stage begin to spin within their capsules. On May 16 the start of the second whorl of the protoconch was noted and two large, darkly pigmented statocysts appeared at the base of the head-foot region. By May 17, velar lobes were well-developed, tiny black eyespots, small cephalic tentacles and a stomodaeum appeared, and spinning of embryos was more rapid. On May 18 the foot was better defined and the protoconch comprised two whorls. No operculum was seen. The pale green color, so indicative of earlier embryonic stages, began to fade and was completely gone by May 19 when embryos were a light tan color. Spinning of embryonic veligers, due to ciliary beat of the velum and foot, was more rapid but sharp jerky movements began and sometimes individuals would periodically stop and resume spinning in a reverse direction. On May 19 the foot was further enlarged and an operculum was present. The larval heart could be seen pulsating within the mantle cavity. The external morphology of embryos remained the same for the next five days, but internal development was obscured by their opaque color. By May 24 the late veliger stage was attained and embryos almost filled their capsules. Statocysts were no longer visible, cephalic tentacles were large and the eyes enlarged. Embryos frequently stopped spinning as they probed the capsule wall. Velar lobes began to disappear, and the embryos began to look like tiny snails. Hatching of juveniles began on May 27 and continued through June 2 until the spawn mass was empty. Five other monitored spawn masses underwent similar development within the same time.

Incubation of embryos lasts from 18–24 days. In general the Link Port population takes about 2.5 to 3.5 weeks to undergo direct development.

*Hatching.*—Young snails escape as the capsule wall splits and breaks apart due to pressure from the foot and snout of the encapsulated snail. Young snails do not leave the interior of the spawn by any definite route or exit but escape randomly. As they emerge from their capsules they crawl about the interstices of the spawn mass which becomes more viscous and begins to slowly disintegrate. After hatching, young snails graze on

detritus of the outer wall of the spawn mass and gradually move off onto grass blades. In May, thousands of juvenile snails, from 0.5–1.8 mm in diameter were observed in the grass beds (Fig. 1g–h). Although obviously of different size classes due to different hatching times and the long spawning period, these young snails may be considered to form one large group of young. Newly hatched snails quickly twist and turn as they explore the environment. Young snails each have large black eyes, a typical radula and a long tactile propodium that bears a heavily ciliated groove along its anterior margin.

*Growth.*—New growth of the protoconch occurs rapidly. Within a few days, a change in sculpture separates the embryonic shell from the new shell growth (Fig. 1h). This is marked by axial shell sculpture that lacks the spiral elements of the protoconch. The aperture becomes angulate and flaring due to the appearance of the median keel that is so indicative of adult shells.

By mid June young snails have added a much larger whorl sculptured with spiral cords and a prominent median keel and have shells that range from 1.3–2 mm in diameter. The outer lip is sharply angulate and the distinctive columellar notch of adults is present (Fig. 1d–f).

Observations were not made during the mid-summer months, but in September young *Modulus* were abundant in the grass beds. No living adults were found but numerous adult shells occupied by hermit crabs were seen. Adolescent *Modulus*, 2–5 mm in size, were covered with thick filamentous green algae and were difficult to detect in the grass beds. Shells were thick and had typical adult sculpture except for their outer lips which were thin due to recent growth. Animals had adult pigmentation and the internal anatomy appeared normal except for the incipient pallial gonoducts. The ctenidium was slightly smaller and comprised only 80 filaments. The pleuro-esophageal connective was slightly longer than in adults; consequently, the RPG ratio of adolescent snails is higher, about 0.70. This indicates a looser concentration of the nerve ring. The ganglia probably become more condensed as they grow larger.

By December, snails have nearly reached adult size and males are ripe. Females become ripe in January. The pallial oviducts are developed but ovaries are just beginning to ripen. By spring (late February–early March) *Modulus* is reproductively mature and the

shell has reached its maximum size. Adults appear to die after spawning, when many empty adult shells may be found.

A summary of these data and other observations indicate that the Link Port population of *Modulus modulus* has a life cycle of one year. Although the spawning period is long and results in various cohorts of young, these overlap to form one large group that develops during spring and grows quickly throughout the year, reaching maturity in late winter–early spring, when spawning occurs. Developmental stages occur throughout the spring with the subsequent emergence of the new progeny and death of adults.

These conclusions are supported by examination of large monthly samples of benthic animals taken from other sites in the Indian River during the Indian River Study conducted by the Harbor Branch Consortium in 1973–1974 (see Young et al., 1974). Growth stages of *Modulus* from these samples fit the general pattern given above. It thus appears that populations of *Modulus* from other areas of the Indian River estuary have a similar life cycle that lasts about one year.

## ECOLOGY

*Modulus modulus* is one of the more common prosobranchs associated with marine grassbeds in Florida and the Caribbean. As an abundant primary consumer it is an important factor in the trophic structure of this ecotone. It is thus surprising that so little was known about its anatomy and ecology.

*General observations.*—A thorough study of the autecology of *Modulus* was not attempted; nevertheless, some ecological observations made during this study will provide information for future workers.

The study site consisted of dense stands of *Halodule wrightii* Ascherson, and two other less common angiosperm grasses, *Syringodium filiformis* Knetz and *Thalassia testudinum* König & Sims, all covered with dense epiphytic growth which traps detritus. The entire site is rich with detritus, and the water is frequently turbid with suspended particulate matter. The salinity in this habitat, normally 33‰, undergoes considerable variation sometimes within a short period of time due to heavy rainfall.

*Modulus* occurs on the grass blades and occasionally on the substratum. The population studied lives at a depth of about one



TABLE 5. Epiphytic algae growing on shells of *Modulus modulus* (\* = dominant).

Phaeophyta	* <i>Sphacelaria furcigera</i> Kützing
Cyanophyta	<i>Microcoleus lyngbyaceus</i> (Kützing) Crouan <i>Callothrix crustacea</i> Thuret
Rhodophyta	<i>Goniotrichum alsidii</i> (Zanardini) Howe
Chlorophyta	<i>Enteromorpha linguleta</i> J. Agardh <i>Cladophora</i> sp.

meter and is never exposed, even at extreme low tides.

Shells of living *Modulus* are normally densely covered with algal epiphytes. A list of these is given in Table 5. The dominant epiphyte is *Sphacelaria furcigera* Kützing. It is noteworthy that this alga does not grow on the sea grasses whereas all of the other epiphytes on *Modulus* occur also on the grasses.

Living *Modulus* snails frequently have an unidentified colonial hydroid growing on the bases and peripheries of their shells. The slipper shell, *Crepidula fornicata* (Linnaeus) may also occur on the base of the shell and barnacles occasionally are found on the shell top.

Empty shells are common and are frequently utilized by the hermit crab *Pagurus bonairensis* Schmitt and the sipunculid *Phascolion cryptus* Hendrix.

**Food and feeding.**—*Modulus modulus* is an active browser that engulfs microphytic algae and detrital particles. Like other microphagous, style-bearing mesogastropods it feeds more or less constantly. Mook (1977: 136) presented evidence that the grazing action of *Modulus* may retard the accumulation of fouling organisms by dislodging their newly settled larvae. *Modulus* thus aids in keeping the surfaces of seagrass blades clear and available as a substratum for microphytic algae.

Stomach contents of freshly-collected specimens contained sand grains, occasional foraminifer tests, numerous diatoms, algae, detrital particles, and fragments of larger filamentous macro-algae. The bulk of the algal contents comprises diatoms and of these, the dominant species is *Melosira moniliformis*, a relatively large diatom. An analysis and identification of stomach contents is presented in Table 6. Fecal pellet analysis shows that detrital particles, sand,

complete diatoms, and diatom fragments pass through the gut. The most common unbroken diatoms in fecal pellets were *Nitzschia* and *Navicula* species. The evidence of stomach, gut and fecal pellet contents leaves no doubt that *Modulus* ingests primarily diatoms. Analysis of the dominant diatoms suggests that larger diatoms are preferred to smaller ones. Although ingested food is not necessarily what is digested by the snail, it is probable that diatoms are the chief source of energy. Gut contents of very young *Modulus* had no appreciable diatom content. This indicates that the young are feeding on different plant food.

**Associations and predators.**—The most common prosobranchs co-existing with *Modulus modulus* on seagrasses are *Cerithium muscarum* Say and *Bittium varium* (Pfeiffer), both cerithiaceans and also style-bearing, algal-detritus feeders. Several other common snails found on the seagrass are the carnivores *Mitrella lunata* (Say) and *Haminoea elegans* (Gray).

The blue crab, *Callinectes sapidus* Rathbun was the only predator observed feeding on *Modulus* and many shells with chipped apertures point to heavy crab predation. Very few drilled shells of *Modulus* were found, suggesting that predation by naticid snails is insignificant. This is not surprising because *Modulus* is generally found on the grass blades and not as frequently on the substrate. Large rays were frequently seen in the grass beds and these along with other fish such as the sheepshead, *Archosargus probatocephalus* Walbaum, are suspected as chief predators. The numerous young snails observed in the spring are thin-shelled and small and are probably eaten by a variety of predators.

**Behavior.**—*Modulus* is a slow-crawling grazer and does not demonstrate a wide variety of behavior. It moves with retrograde, monotaxic muscular waves and sudden jerky motions. Although its normal habitat is on the blades of seagrass it will move down onto the substratum when weather conditions cause estuary waters to be rough.

When irritated or attacked, *Modulus* strongly twists itself, turning its shell back and forth with the columellar muscle, as if to dislodge a predator. If the irritation continues, the hypobranchial gland exudes a mass of sticky particles that probably discourages predators. The animal will then withdraw completely into its shell, about 5 mm beyond the edge of the

TABLE 6. Analysis of algal stomach contents of *Modulus modulus*.

Taxon	Mean size (M)		Form	Jan.	Feb.	May
	Diameter	Height				
Class BACILLARIOPHYCEAE						
Order Centrales						
Suborder COSCINODISCINEAE						
Family MELOSIRACEAE						
<i>Melosira moniliformis</i>						
O. F. Müller	24.4	26.9	chains	*	+	-
<i>Melosira sulcata</i>						
Ehrenberg	19.5	17.1	chains	-	+	-
Order PENNALES						
Suborder ARAPHIDINEAE						
Family FRAGILARIACEA						
<i>Synedra</i> sp.						
(fragments only)	16.1		chains	+	+	-
<i>Striatella unipunctata</i>						
Agardh (fragments only)	56.1	68.3	chains	-	+	*
<i>Rhabdonema</i> sp.	9.8	44.0	chains	+	-	-
Suborder BIRAPHIDINEAE						
Family NITZSCHIACEAE						
<i>Nitzschia</i> sp.	5.2	61	solitary	-	+	+
Family NAVICULACEA						
<i>Mastogloia crucicula</i>						
(Grunow) Cleve	14.22	10	solitary	+	-	-
<i>Mastogloia</i> sp.	11.5		solitary	+	-	-
<i>Navicula</i> sp.	25.3		solitary	-	-	+
Family SURIRELLANCEAE						
<i>Camplyodiscus</i> sp.	95		solitary	-	-	+

\*Dominant species

+Present

-Absent

outer lip, until the operculum snugly fills the aperture.

*Modulus* reacts violently with the same twisting movements when it is exposed to secretions given off by other wounded *Modulus* snails, and will move rapidly away. This behavior has been documented in other marine and freshwater snails by Snyder (1967; 1971).

## DISCUSSION

A consideration of the interrelationships of higher taxa is contingent upon the amount and quality of comparative data available. Many familial definitions are based only on shell characters and there are few comprehensive anatomical studies upon which to rely. I have used the anatomical data I found available for cerithiaceans, although this was

frequently incomplete and/or contradictory. Thus my conclusions, while based on anatomical evidence, are tentative and partially speculative.

On the basis of anatomy, I believe that the Modulidae should be regarded as a distinct family within the Cerithiacea. On balance, *Modulus* species share more anatomical characters in common with members of this superfamily than with any other group. They appear to be closest to the Cerithiidae and Potamididae. My reasons for these conclusions are developed in the following discussion.

*Phylogenetic relationships.*—*Modulus* species differ conchologically from other cerithiaceans by their turbinata shape and umbilical notch. The family is a small one (one genus and about 6 species) in comparison with other cerithiacean families such as the Cerithiidae, Potamididae, Dialidae, Turritel-

laidae and Vermetidae, all comprising numerous genera and species.

Risbec (1927: 17) believed that the family Modulidae was intermediate between the Cerithiidae and Strombidae and cited a number of characters that he said were shared with each group. His remark that both cerithiid and *Modulus* species have short anterior siphons is incorrect: two genera of cerithiids, e.g. *Rhinoclavis* and *Pseudovertagus*, are characterized by long siphonal canals (Houbrick, 1978). Risbec (1927) also erroneously reported that *Modulus* and the cerithiids lacked salivary glands. As I have demonstrated in this paper and others (Houbrick, 1974a, 1978) both *Modulus* and all cerithiids heretofore studied have salivary glands. Bright (1958: 135) has reported salivary glands in a potamidid, *Cerithidea*, and I have observed them in *Batillaria*. I do not agree with Risbec's (1927) opinion that *Modulus* has close affinities with the Strombidae. While his observation that the anterior position of the eyes on the tentacles of *Modulus* is shared with the strombs is correct, his citation of a crystalline style as a unique shared character is incorrect because a style is characteristic of most algal-detrital feeders in the Mesogastropoda. He was apparently unaware that many cerithiaceans have styles. Risbec's (1927) citation of an osphradium with indistinct lamellae as a shared character between the Modulidae and Strombidae is accurate, but among the Cerithiinae, the Potamididae also have a similar osphradium (personal observation). The similarity of the radula between *Modulus* and *Strombus* species is superficial: any similarity is probably due to convergence of generalized taenioglossate radulae adapted for feeding on epiphytic algae and detritus. The reproductive tract of *Modulus* is very different from that of *Strombus*. The open condition of the pallial gonoducts in both sexes and a lack of a penis in males are conservative cerithiacean characters not seen in the Strombidae.

Although comparison may be made between the sudden jerk-like motions of a crawling *Modulus* and those of *Strombus*, the movement of the former is more like that of other cerithiids, only more pronounced, and is in no way similar to the jumping motions of *Strombus*.

Aside from the turbinate shape of the shell, *Modulus* also has some distinctive anatomical features. Among these are short, stout pallial tentacles that reach extreme development in *M. tectum*. Pallial tentacles are also

present in cerithiid genera such as *Cerithium*, *Rhinoclavis*, *Pseudovertagus*, *Clypeomorus* and *Bittium*, but in relation to the animals' body they are never of the same size as are those of *Modulus*. Another distinctive feature of the external anatomy is the forward position of the eyes on the tentacles. In the Cerithiidae, Potamididae, Turritellidae and Vermetidae, the eyes are located at the bases of the cephalic tentacles. Although the Strombidae are similar to the Modulidae in regard to eye placement, this does not necessarily indicate close relationship, as noted before.

An unusual feature of the mantle cavity in *Modulus modiolus* is the large and highly glandular hypobranchial gland. The ability of this gland to exude salvos of sticky mucoid particles and discharge them via the exhalant siphon is, to my knowledge, unrecorded for other cerithiaceans. I assume that this behavior, coupled with quick twisting movements of the body, is a deterrent to predators. Although the hypobranchial gland of *M. tectum* is not exactly the same, the identical twisting behavior was noted. Another noteworthy feature of the mantle cavity of *Modulus* is the sinuously twisted distal portion of the osphradium that ends near the entrance of the inhalant siphon. The osphradium is a ridge-shaped structure much like the osphradium seen in the members of the Potamididae, while in species of the Cerithiidae, it is bipectinate.

The placement of the salivary glands and their ducts anterior to the cerebral commissure is a noteworthy feature of *Modulus*. The salivary ducts do not appear to pass through the nerve ring, but sections show that they begin very close to it. Although this arrangement is unlike that of many monotocardians, it is shared by the cerithiid genera *Cerithium*, *Rhinoclavis*, *Pseudovertagus* and *Clypeomorus* (personal observation) and has been described by Davis et al. (1976: 276) in members of the rissoacean families Assimineidae, Truncatellidae, Bithyniidae and Hydrobiidae. In *Modulus*, the passage of a portion of the left salivary gland through the nerve ring and partially behind the cerebral commissure, shows that the Modulidae stand in an intermediate position among the Mesogastropoda in regard to this trait. Some *Cerithium* species also have a similar arrangement of the left salivary gland. Bright (1958: 134) found that the salivary glands and ducts of the potamidid, *Cerithidea californica* (Haldeman, 1840) were located behind the nerve ring next to the "crop" (esophageal gland). He noted that the

left gland was the largest and that the salivary ducts were highly convoluted and partially embedded in the connective tissue of the "preesophagus" (anterior esophagus). It is not clear from his statement that the ducts pass through the nerve ring but his figure indicates this is the case. Thus, while most mesogastropods have their salivary glands located behind the cerebral commissure they lie anteriorly in some rissoaceans and have an intermediate position in the Modulidae and in many Cerithiidae. This supports Davis' (1976: 276) position that location of salivary glands and their ducts is a poor character to differentiate mesogastropods from stenoglossan neogastropods.

The combination of a well-developed esophageal gland and a crystalline style in *Modulus*, although thought to be unusual in mesogastropods (Fretter & Graham, 1962: 220), is a common condition shared with cerithiids I have examined in the genera *Cerithium*, *Rhinoclavis*, *Pseudovertagus* and *Clypeomorus*. Sections of this large gland in *Modulus* clearly show numerous and deep glandular lateral outpouchings arising from the mid-esophagus, leaving no doubt about its function.

The nervous system of *Modulus* differs from that of *Cerithium* or *Rhinoclavis* in lacking a large siphonal ganglion, but this may be due to the short siphon of *Modulus*. It is interesting to compare the RPG ratio of *Modulus* with that of other marine mesogastropods. Davis et al. (1976: 267) presented a table of RPG ratios which compared selected hydrobiid, rissoid and littorinid taxa. As mentioned previously, the higher the value of the RPG ratio the less concentrated are the ganglia of the nerve ring and presumably the more prim-

itive the nervous system. In Table 7, I compare the ratios of selected cerithiaceous taxa. The mean value for *Modulus* is the same as in *Cerithium*, 0.59, but both of these taxa have lower values than the potamidid, *Batillaria minima*, which has a value of 0.77, closer to the littorinid value.

*Modulus* has one of the more complex pallial oviduct systems found in the Cerithiacea. The open pallial gonoducts of some Cerithiacea have been surveyed by Johansson (1953; 1956), Fretter (1951), Fretter & Graham (1962: 625) and Houbrick (1971; 1974a, 1977, 1978). Although all of the species studied have a basic groundplan of open pallial gonoducts, those of *Bittium* and *Cerithiopsis* are very complex in organization. However, the allocation of *Cerithiopsis* within the Cerithiacea is uncertain. The layout of the pallial gonoducts of *Modulus* are even more complex and unusual. While one can interpret the pallial gonoducts of the Cerithiacea from a functional viewpoint, it is difficult to relate these open systems to each other in a comparative systematic manner. As Johansson (1953: 8) pointed out, pallial gonoducts sometimes differ considerably, even in closely related species. This has been seen in several rissoaceans (Johansson, 1953) and I have found many differences in the arrangement of the sperm gutter, bursa copulatrix and seminal receptacle in different species of *Cerithium*, *Clypeomorus* and *Rhinoclavis*. Too little is known of the arrangement of the gonoducts in other members of the Cerithiacea to discuss their comparative anatomy satisfactorily; moreover, the epithelial origin of pallial gonoducts renders any homologies suspect. Thus, any attempt to decide what is a primitive or derived state would be premature and purely speculative. Nevertheless the unique groundplan of the pallial gonoducts of *Modulus* clearly separates the Modulidae from other cerithiaceous families and is a reliable discriminating character.

I have observed spermatophores in other cerithiid members of the genera *Cerithium*, *Rhinoclavis*, and *Gourmya* and suspect that this method of sperm transfer is characteristic of the group. Spermatophores have also been described by Dazo (1965) in the freshwater cerithiaceous *Goniobasis*. The spermatophore of *Modulus* has a more complex surface structure and shape than those I have seen in the cerithiid species. The general physiognomy of the sperm of *Modulus* and in particular the elongate midpiece of the eupyrene

TABLE 7. The RPG ratio for selected cerithiid, modulid and potamidid taxa. (This ratio is the length of the pleuro-esophageal connective divided by the sum of the lengths of the supraesophageal ganglion, pleuro-supraesophageal connective and right pleural ganglion).

Taxon	RPG
Cerithiacea	
Cerithiidae	
<i>Cerithium lutosum</i> Menke	0.59
<i>Cerithium atratum</i> (Born)	0.59
Modulidae	
<i>Modulus modulus</i> (Linnaeus)	0.59
Potamididae	
<i>Batillaria minima</i> (Gmelin)	0.77

spermatozoon, are comparable to those described for other cerithiids, e.g. *Cerithium* (Tuzet, 1930; Houbrick, 1973), *Bittium* and *Cerithiopsis* (Fretter & Graham, 1962).

*Interspecific comparisons.*—Aside from the observations presented in this paper and those recorded on the anatomy of *Modulus tectum* by Risbec (1927) (cited as *Modulus candidus* Petit), nothing is known of the anatomy or ecology of other *Modulus* species. I was able to study *Modulus tectum* in Fiji and offer the following observations for comparison with *M. modulus*. *Modulus tectum* differs from *M. modulus* by living on hard substrates in coral reef habitats. It is a much larger snail and not abundant. *Modulus tectum* clamps tightly on dead coral rubble when disturbed and is dislodged with difficulty. It has a transparent operculum through which may be seen the foot, brightly colored with large orange spots and irregular white blotches on a black pigmented background. These bright colors and the eye-like spots may startle predators who are able to remove snails from the rocks. Males are smaller than females and both sexes have highly colored soft parts. The snout is dark brown and spotted with white while the tentacles are reddish and papillate. The eyes are located near the distal ends of each tentacle, as in *M. modulus*. The foot is reddish brown and covered with whitish blotches and small brown dots. A large propodial furrow is present. The foot is much broader than in *M. modulus* and serves to keep the animal tightly clamped to the substrate. The mantle edge has long pinnate or multi-branched papillae in contrast to the simpler mantle papillae of *M. modulus*. The hypobranchial gland is smaller than that of *M. modulus*. When irritated, *M. tectum* does not emit salvos of sticky mucoid particles as does *M. modulus*. *Modulus tectum*, however, makes the same violent twists as *M. modulus* when irritated, but the former also clamps down on the substratum to discourage predators.

The thick, open pallial oviduct of *Modulus tectum* is highly glandular and the outer lamina is internally more convoluted with glandular folds than that of *M. modulus*. The male pallial gonoduct has a large yellow glandular area located on the inner lamina adjacent to the columellar muscle. This may be homologous to the structure seen in *M. modulus* and is probably a spermatophore-forming organ. Females of *M. tectum* have a large ovipositor on the mid right side of the foot that is identical

to that I have described in *M. modulus*. Within the buccal cavity of *M. tectum*, lying anterior to the nerve ring, are paired salivary glands with ducts that empty into the anterior esophagus. The radula is very much like that of *M. modulus*. Behind the nerve ring the esophagus rapidly widens and a large, wide, chocolate-colored esophageal gland is present.

The large black kidney is covered with a network of fine white branch-like blood vessels. The testis is light green and a large vas efferens runs from the testis to the pallial gonoduct along the inside of the whorls. In females the ovary is dark green and filled with large green ova that suggest direct development may take place. Green ova were also seen in *M. modulus*.

*Reproductive biology.*—Spawn masses of *Modulus modulus* are deposited at Link Port at the same time as those of *Cerithium muscarum*. Both species are abundant on seagrasses, undergo direct development, and their spawn is somewhat similar. Thus, spawn masses of both species may be confused and future workers should be alerted to this fact. They can be easily separated with careful examination. The spawn of *Modulus* is deposited along the axis of a seagrass blade as a cylindrical tube with smooth outer walls and resembles a caterpillar, whereas that of *Cerithium muscarum* is a more irregular, disk-like mass with a lumpy outer surface. I have figured the spawn of *Cerithium muscarum* elsewhere (Houbrick, 1973: 880; 1974a: 78). The embryos and young snails of the two species are also different. *Cerithium* embryos do not have the pale green color of *Modulus* embryos during their earlier stages of development. The embryonic shells and protoconchs of newly hatched *Cerithium muscarum* are characterized by the purple color of the outer lip and umbilical region. The aperture is oval while in *Modulus* it is more angulate. Finally, the embryonic shell and protoconch of *Cerithium muscarum* lack the spiral striae so characteristic of *Modulus*.

The reproductive mode of the Link Port population of *Modulus modulus* is direct. It is interesting to note that Lebour (1945: 470–471), in Bermuda, and Bandel (1976: 258) in Santa Marta, Colombia, each observed indirect development in *Modulus modulus*. These observations are contrary to what I have seen and present a discrepancy for which there are several possible explanations: 1) Both Lebour (1945) and Bandel (1976) were mistaken about the identity of their specimens; 2) What

has been called *Modulus modulus* in the stenohaline environments of Bermuda and the Caribbean is a separate species; 3) *Modulus modulus* has two developmental modes.

The first explanation is unlikely because *Modulus carchedonius*, which has planktonic larvae, has not been recorded from Bermuda and Bandel (1976) described the spawn of both species of *Modulus* at Santa Marta.

The second explanation, while possible, does not seem to be likely. Although considerable variation in shell sculpture occurs between populations of *Modulus modulus*, there are intergrades between the various morphs indicating that there is but a single species. Abbott (1944: 4) believed that these differences were within the normal range of variation and regarded them as one species. I have examined the extensive collections at the National Museum of Natural History and concur with him. I have examined the anatomy and radulae of the Caribbean forms and find no differences.

I believe that the third explanation is the most probable, and that *Modulus modulus* has a reproductive strategy comprising two developmental modes, direct and indirect. These modes are correlated with euryhaline and stenohaline environments, respectively. The utilization of direct development by estuarine populations such as those at Link Port may provide better protection against sudden changes in salinity or exposure and thus enhance the maintenance and survival of the embryos. Although not a common phenomenon, there are seven documented cases of a single species having both direct and indirect developmental modes. These have been reviewed by Robertson (1974: 227). Intraspecific variation of developmental modes has also been recorded among other invertebrates such as echinoderms and polychaetes.

*Modulus carchedonius* is the only other species for which eggs and larvae have been described. This species has free-swimming planktonic larvae. The spawn masses of this species differ from those of *M. modulus* by having an inner cavity formed by the outer walls of the egg mass. The spawn masses of *M. carchedonius* contain many more embryos (7,000) that hatch in 5–6 days as free swimming veligers (Bandel, 1976: 259–260, fig. 12,a, b).

The populations of *Modulus modulus* that Lebour (1945) and Bandel (1976) observed had smaller and more numerous eggs, and a

short incubation period of 5–7 days prior to hatching, typical of indirect development. In these populations the egg capsules dissolved and the veligers swam into the hollow center of the spawn mass and then to the outside. Spawn masses of the Link Port population did not have hollow centers. The longer developmental time of the Link Port population is similar to those I have observed in *Cerithium lutosum* and *C. muscarum*, euryhaline species which also have direct development (Houbrick, 1973, 1974b).

The developmental mode of *Modulus modulus* is much like those of *Cerithium muscarum* Say and *Cerithium lutosum* Menke (Houbrick, 1973). The veliger stage of *Modulus modulus* was reached in five days, about the same rate observed in *C. muscarum*, and the total incubation period of the former (2–3 weeks) is likewise similar to those of the *Cerithium* species cited above. *Cerithium muscarum* shares many of the reproductive and developmental patterns seen in *Modulus modulus* such as open pallial gonoducts, spermatophores, dimorphic sperm, spawn masses and direct development. Moreover, both species are abundant and occur together in the same habitat. This is probably explained by a common reproductive anatomy imposed by similar phyletic origin as well as convergence due to similar ecology.

#### ACKNOWLEDGEMENTS

Most of this study was done at the Smithsonian's Fort Pierce Bureau, Fort Pierce, Florida. I thank Dr. Mary Rice for her assistance while using these facilities. I extend special thanks to Julie Piraino for her help with laboratory equipment. I also thank Joseph Murdoch and Dr. John Pilger for their help both in the lab. and field. Pat Linley, of Harbor Branch Foundation, assisted with histological preparations. Grateful thanks are extended to Ron Mahoney, Robert Gibson and Penny Hall of Harbor Branch Foundation, who kindly identified the algae for me. I thank Dr. Uday Raj, University of The South Pacific, Suva, Fiji, for lab. space and assistance in collecting. June Jones kindly typed portions of the manuscript. I also wish to thank Susann Braden, SEM Laboratory, National Museum of Natural History, for assisting with operation of the SEM. Victor Krantz, of the National Museum of Natural History Photography Lab, took pictures of

shells. Cathy Lamb assisted with proofing the manuscript, and Mary Parrish typed the final draft. This is Smithsonian's Fort Pierce Bureau contribution number 41.

## LITERATURE CITED

- ABBOTT, R. T., 1944, The genus *Modulus* in the western Atlantic. *Johnsonia*, 14: 1-6, 2 pl.
- ADAMS, A., 1851, A monograph of *Modulus*, a genus of gasteropodous Mollusca, of the family Littorinidae. *Proceedings of the Zoological Society of London for 1850*, 18: 203-204.
- BANDEL, K., 1976, Observations of spawn, embryonic development and ecology of some Caribbean lower Mesogastropoda. *Veliger*, 18: 249-271.
- BRIGHT, D. B., 1958, Morphology of the common mudflat snail, *Cerithidea californica*. *Bulletin of the Southern California Academy of Science*, 57: 127-139.
- DALL, W. H., 1892, Contributions to the Tertiary fauna of Florida with especial reference to the Miocene Silex-beds of Tampa and the Pliocene beds of the Caloosahatchee River. *Transactions of the Wagner Free Institute of Science, Philadelphia*, 3: 1-947, 35 pl.
- DAVIS, G. M., KITIKOON, V., & TEMCHAROEN, P., 1976, Monograph on "*Lithoglyphopsis*" *aperta*, the snail host of Mekong River schistosomiasis. *Malacologia*, 15: 241-287.
- DAZO, B. C., 1965, The morphology and natural history of *Pleurocera acuta* and *Goniobasis livescens* (Gastropoda: Cerithiacea: Pleuroceridae). *Malacologia*, 3: 1-80.
- FRETTER, V., 1951, Observations on the life history and functional morphology of *Cerithiopsis tubercularis* (Montagu) and *Triphora perversa* (L.). *Journal of the Marine Biological Association of the United Kingdom*, 29: 567-586.
- FRETTER, V. & GRAHAM, A., 1962, *British prosobranch molluscs, their functional anatomy and ecology*. Ray Society, London, 755 p.
- GRAHAM, A., 1938, On a ciliary process of food-collecting in the gastropod *Turritella communis* Risso. *Proceedings of the Zoological Society of London*, ser. A, 108: 453-463.
- HALDEMAN, S. S., 1840, *A monograph of the freshwater Limniades and other freshwater univalve shells of North America*, No. 1: 1-16, 5 pl.
- HOUBRICK, R., 1971, Some aspects of the anatomy, reproduction, and early development of *Cerithium nodulosum* (Bruguière) (Gastropoda Prosobranchia). *Pacific Science*, 24: 560-565.
- HOUBRICK, R., 1973, Studies on the reproductive biology of the Genus *Cerithium* (Gastropoda: Prosobranchia) in the western Atlantic. *Bulletin of Marine Science*, 23: 875-904.
- HOUBRICK, R., 1974a, The genus *Cerithium* in the western Atlantic. *Johnsonia*, 5: 33-84.
- HOUBRICK, R., 1974b, Growth studies on the genus *Cerithium* (Gastropoda: Prosobranchia) with notes on ecology and microhabitats. *Nautilus*, 88: 14-27.
- HOUBRICK, R., 1977, Reevaluation and new description of the genus *Bittium* (Cerithiidae). *Veliger*, 20: 101-106.
- HOUBRICK, R., 1978, The family Cerithiidae in the Indo-Pacific, Part 1: The genera *Rhinoclavis*, *Pseudovertagus* and *Clavocerithium*. *Monographs of Marine Mollusca*, No. 1: 1-30.
- JOHANSSON, J., 1953, On the genital organs of some mesogastropods: *Cerithium vulgatum* Brug., *Triphora perversa* (L.) and *Melanella (Eulima) intermedia* (Cantr.). Contributions to the Prosobranchia. *Zoologiska Bidrag från Uppsala*, 30: 1-23, pl. 1.
- JOHANSSON, J., 1956, On the anatomy of *Tympanotonus fuscatus* (L.), including a survey of the open pallial oviducts of the Cerithiacea. *Atlantide Report*, No. 4: 149-166, pl. 1.
- LEBOUR, M. V., 1945, The eggs and larvae of some prosobranchs from Bermuda. *Proceedings of the Zoological Society of London*, 114: 462-489.
- LINNAEUS, C., 1758, *Systema naturae per regna tria naturae*. Editio decima, reformata. Stockholm, vol. 1, Regnum animale, 824 p.
- MARCUS, E. & MARCUS E., 1964, On *Cerithium atratum* (Born, 1778). *Bulletin of Marine Science*, 14: 494-510.
- MOOK, D., 1977, Studies on fouling invertebrates in the Indian River, Florida 2: Effects of *Modulus modulus* (Prosobranchia: Modulidae). *Nautilus*, 91: 134-136.
- REEVE, L. A., 1865, *Conchologia Iconica: or illustrations of the shells of molluscous animals*. Vol. 15, *Cerithium*, 20 pl. + index.
- RISBEC, J., 1927, De l'anatomie de trois strombidés et du *Modulus candidus*, Petit qu'on trouve vivant sur la côte de la presqu'île de Noumea. *Annales du Musée d'Histoire Naturelle de Marseille*, 21: 1-18, pl. 28.
- ROBERTSON, R., 1974, Marine prosobranch gastropods: larval studies and systematics. *Thalassia Jugoslavica*, 10: 213-238.
- SNYDER, N., 1967, An alarm reaction of aquatic gastropods to intraspecific extract. *Cornell Experiment Station Memoir* 403, 122 p.
- SNYDER, N. & SNYDER, H., 1971, Pheromone-mediated behavior of *Fasciolaria tulipa*. *Animal Behaviour*, 19: 257-268.
- SOWERBY, G. B., 1855, *Thesaurus Conchyliorum, or monographs of genera of shells*. Vol. 2, *Cerithium*: 847-859, pl. 176-186.
- TRYON, G. W., 1887, *Manual of conchology; structural and systematic; with illustrations of the species*. Ser. 1, 9: *Cerithium*, p. 127-149, pl. 20-29.
- TUZET, O., 1930, Recherches sur la spermatogenèse des prosobranches. *Archives de Zoologie Expérimentale et Générale*, 70: 95-229, 12 pl.
- YOUNG, D., AVENT, R., BRIEL, L., ELSEMAN, N.,

GORE, R., JONES, R., KERR, G., SEIBERT, H., VAN ZWECK, O., & WILCOX, J., 1974, Indian River study. First annual report, Harbor Branch consortium. Unpublished manuscript, 2 vols., 385 p.

YOUNG, D., BUZAS, M., & YOUNG, M., 1976, Species densities of macrobenthos associated with seagrass: A field experimental study of predation. *Journal of Marine Research*, 34: 577-592.



ON *PATRO AUSTRALIS* WITH COMPARISONS OF STRUCTURE  
THROUGHOUT THE ANOMIIDAE (BIVALVIA)

C. M. Yonge

*Department of Zoology, University of Edinburgh,  
West Mains Road, Edinburgh EH9 3JT, Scotland*

ABSTRACT

Study of specimens of *Patro australis* has involved further consideration of the Anomiidae,<sup>1</sup> in particular the extent of the differences between the more primitive *Pododesmus* (*Monia*) and the more modified *Anomia*. These are now extended to include comparisons of visceral structure. In *Pododesmus* the visceral mass surrounds the centrally placed byssal apparatus, the two (very similarly sized) gonads arranged in the same longitudinal plane. The greater effects of lateral compression in *Anomia* involve restriction of the visceral mass to posterior and ventral surfaces of the byssal apparatus with great reduction of the left gonad but extension of the right gonad into both right and left mantle lobes. The distinctive features of *Heteranomia* are seen to include enclosure of the base of the foot within the left gonad. *Patro australis* resembles *Anomia* in most respects, the major differences being conchological, but is adapted for life on a more uneven surface and under more turbid conditions.

INTRODUCTION

In a recent general account of the superfamily Anomiacea (Yonge, 1977), very significant differences in structure (although not in habit, both living closely applied to flat surfaces) were found between species of what proved to be much the less structurally specialized *Pododesmus* (*Monia*) and those of the much more highly modified *Anomia*. *Heteranomia* with much the same mode of life differs from both but primarily in ctenidial structure. *Enigmonia*, however, despite its remarkably modified form and unique mode of life—a kind of bivalve limpet spending much time out of water on leaves and stems in the extremely damp atmosphere of mangrove swamps—has the same basic structure as *Anomia*.

*Patro australis* (Gray) was also examined but only by way of empty shells obtained from the British Museum (Nat. Hist.). This species is stated by Iredale (1939) to occur all around the north of Australia but Beu (1967) extends this south to Victoria on the east. The observations of both were confined to shells, Beu stating of *P. australis* that "It appears that these forms occupy some situation where the shell is able to grow unrestricted." Personal conclusions were to the same effect, the area of byssal attachment being somewhat more

limited than in *Anomia* spp., the valves much more irregular with the posterior margins raised clear of the surface to facilitate egress of faeces and especially pseudofaeces. A drawing was made showing this suggested posture (Yonge, 1977, fig. 21).

More recently four preserved specimens of this species have been obtained from the Australian Museum, Sydney. The locality and habitat, given on the label, are "Saibai Village, Saibai, Torres Strait, N. Queensland, muddy sand and rock flat in front of village. Low tide 7 July, 1976." This species was originally described by Gray (1847) from the collections of the "Fly" as *Anomia australis* and then renamed by him in his review of the "Anomiadae" (Gray, 1849) as *Patro elyros*, this corrected to *Patro australis* by Iredale (1939). All taxonomic data have been based on shell characters and the initial purpose of this study was to check differences in internal structure between this and other anomiids. This has inevitably involved some re-examination and comparisons of structure in *Pododesmus cepio*, *Anomia ephippium*, *A. simplex* and *Heteranomia squamula* (the four species earlier examined) with results which extend previously published conclusions (Yonge, 1977). Further data are provided about the nature and significance of structural modifications in the Anomiidae.

<sup>1</sup>As restricted to exclude *Placunanomia* and *Placuna* (Yonge, 1977).

## ABBREVIATIONS USED IN THE FIGURES

a	anus
ad	adductor
adc	catch muscle of adductor
adq	quick muscle of adductor
aol	anterior outer ligament layer
aprl	anterior pedal retractor, left
aul	auricle, left
aur	auricle, right
bn	byssal notch
br	byssal retractor
by	byssus
cr	crurum
cs	crystalline style sac
ctl	ctenidium, left
ctr	ctenidium, right
f	foot
hg	hypobranchial gland
il	inner ligament layer
isl	boundary of inner shell layer
m	mouth
mbn	membrane around byssal notch
mi	mantle isthmus
obn	opening of byssal notch
ogl	oral groove, left
ogr	oral groove, right
pbr	posterior byssal retractor
pol	posterior outer ligament layer
pl	labial palps, left
pr	labial palps, right
u	umbo
v	ventricle
vg	visceral ganglion
vma	visceral mass, anterior
vmp	visceral mass, posterior
vmv	visceral mass, ventral

## SHELL STRUCTURE

The shell in the Anomiacea is described by Taylor, Kennedy & Hall (1969) as consisting in the main of calcitic, foliated structure, the restricted inner shell layer (Fig. 3, isl) is of aragonitic, complex crossed-lamella structure, the muscle scars which they surround "leave a trace of aragonite, prismatic myostracum through the complex crossed-lamellar layer." Their observations were largely confined to species of *Anomia* but Beu (1967) finds that in

the three species of *Patro* which he examined the here somewhat thicker right (under) valve is prismatic, a notable distinction from *Anomia*. He also notes that the shell in all these species is more inflated than in *Anomia* or *Pododesmus* (those of *Enigmonia* and *Placuna* even more flattened). He noted that the shells were usually "regularly subcircular with the left (upper) valve "slightly saddle-shaped." His largest specimen was 60 mm long with the right valve 2 mm thick. Of the four specimens here available, all were roughly circular in outline with the greatest diameters ranging from 18 to 45 mm. All were inflated. One, shown in Fig. 1, was attached to a stone to the rounded side of which it conformed although projecting marginally. The right valves of all were internally convex (Fig. 6) indicating a general tendency to settle on rounded rather than flat surfaces. The upward extensions of the posterior margin, although present, were not so well marked in these specimens as they were in the shell originally figured.

The upper surface of the left valve (Fig. 2) has what Beu describes as a "regular fine sculpture of radial ribs, of which every tenth is stronger than the others." Internally (Fig. 3) the restricted white inner shell layer down the centre is largely occupied by three large muscle scars, the most ventral that of the adductor, the other two those of the divided posterior byssal retractor. The larger (more dorsal) one (br), as in Anomiidae generally, is larger than that of the adductor (ad). In addition, just below the anterior margin of the resifier, there is the scar of the small left anterior pedal retractor. Conditions here are similar to those in *Anomia* although, as Beu

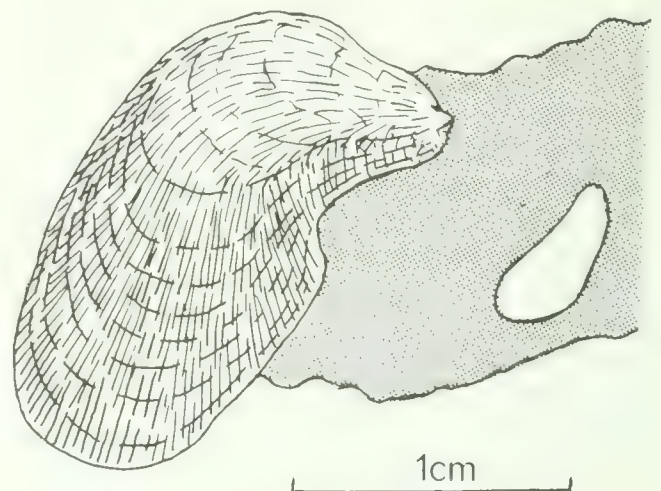

FIG. 1. *Patro australis*, animal attached to rounded surface.

points out, the three major scars are somewhat more vertically arranged; the anterior retractor scar (aprl) is also somewhat larger.

In *Pododesmus* the byssal retractor is only rarely divided. In *Heteranomia* the adductor and posterior pedal retractor scars merge into one as pointed out by Winckworth (1922) who separated the genus on this basis together with the distinctive ctenidia described by Ridewood (1903) and Atkins (1936).

The characteristic deep notch on the right valve is distinctly smaller in *Patro* than in spe-

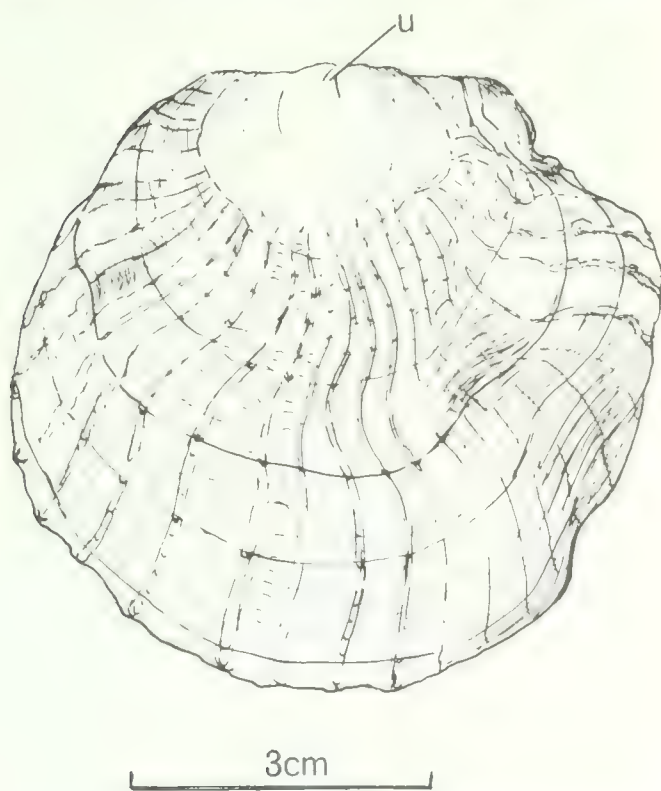

FIG. 2. *P. australis*, left valve, outer surface (from Yonge, 1977).

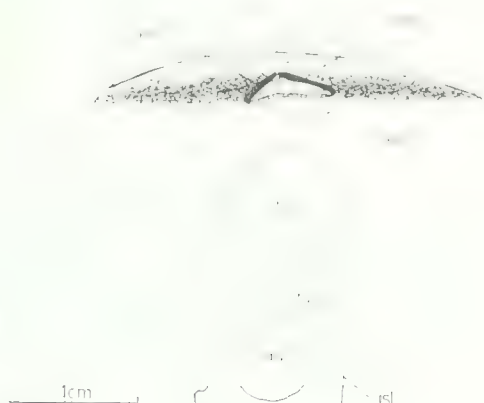

FIG. 3. *P. australis*, left valve, inner surface showing ligamental attachments (inner layer hatched, outer layers black) with inner shell layer containing three major muscle scars.

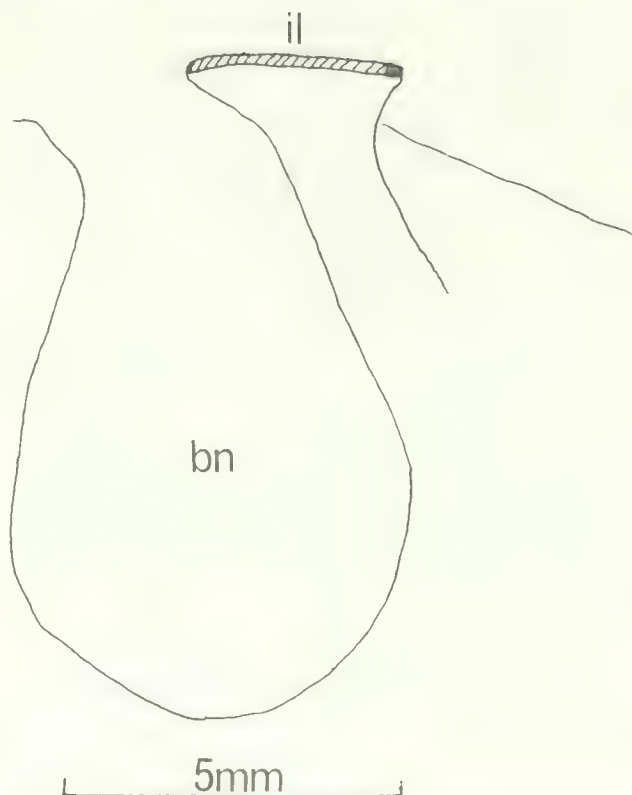

FIG. 4. *P. australis*, inner surface of dorsal region of right valve showing byssal notch with crurum and attachment of inner ligament layer.

cies of *Pododesmus* and *Anomia*. Moreover, as shown in Figs. 4–6 the notch is always wide open which is not true for either of the other genera where it is often completely closed by approximation, and sometimes fusion, of the anterior margin with the crural area. There also the calcified byssus may become fused with the margins of the notch (or foramen as it may become). There is no evidence that this happens in *Patro* where the animal has a more restricted area of attachment. The subcrural groove on the under face of that structure (permitting dorsal extension of byssal fibres) which is so very well marked in *Pododesmus* (Yonge, 1977) is absent in *Patro* and there is no attachment of a right anterior pedal retractor to the inner base of the crurum. The only muscle scar on the right valve is that of the adductor. In all three respects *Patro* resembles *Anomia*.

#### LIGAMENT

Owing to the extent to which the left valve overarches the right valve dorsally, the ligament in the Anomiidae is vertically instead of laterally disposed. It is topographically extended horizontally, parallel to the substrate.

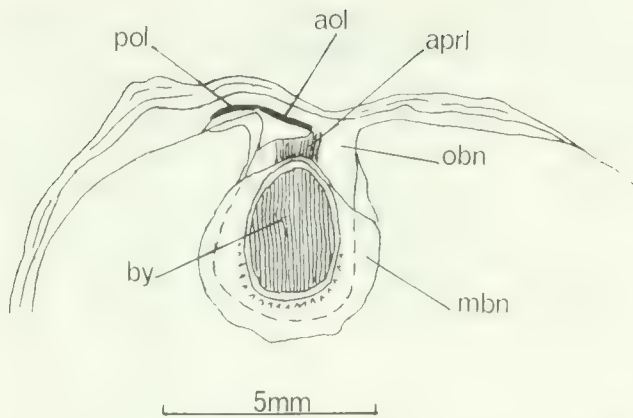

FIG. 5. *P. australis*, intact animal, under (right) view of byssal region showing widely open byssal notch with united anterior and posterior outer ligament layers on under (outer) side of crurum.

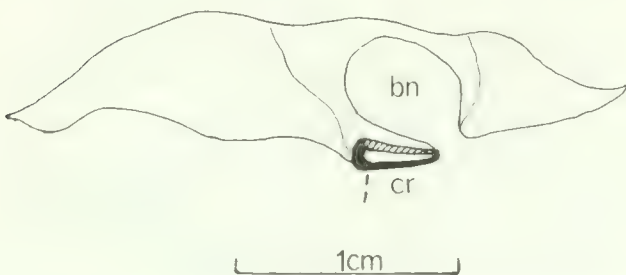

FIG. 6. *P. australis*, right valve viewed from dorsal aspect showing convex form also crurum with complete oval-shaped ligament, position of union of anterior and posterior outer layers indicated by broken line.

As previously shown (Yonge, 1977) this over-arching by the left valve involves a "supradorsal" extension of the mantle margins at both ends of the ligament. This results in secretion of shell *outside* the ligament and consequent displacement of the umbo from the margin (Fig. 7). At the same time the anterior and posterior outer (lamellar) ligament layers are bent back topographically below the inner ligament layer secreted by the mantle isthmus (Figs. 3–6).

Conditions on the right (under) valve are profoundly influenced by the presence of the relatively enormous anomiid byssal notch which, as shown in Figs. 4 and 6, stretches within and to the anterior of the ligamental region. In consequence on this valve the resilifer surface occupies the summit of a unique anomiid type of chondrophore known as a crurum. In side view this is straight both in *Patro* (Fig. 4) and *Anomia*, unlike *Pododesmus* where it is convex. Although there cannot be supradorsal extension of the shell on this side, the outer ligament layers (secreted by

epithelia which stretch between the valves) are inevitably bent in an oval around the topographically under side of the crurum. The resultant form of the ligament is best realized by viewing a right valve from the dorsal aspect (Fig. 6). The flat resilifer surface of the crurum bears the inner ligament layer (il) on its upper (i.e. interior) surface and the united anterior and posterior outer layers (ad, pol) on the lower (i.e. outer) surface. In life these layers are, of course, continuous with those on the upper, left valve shown in Fig. 3.

Conditions, however, are somewhat more advanced in *Patro* than *Anomia*, indeed there is an interesting gradation of ligamental structure starting with that in *Pododesmus* and indicated semi-diagrammatically in Fig. 7. In *Pododesmus* (A) initial supradorsal extension of the mantle margins and so of the outer valve layers they secrete is followed by their retreat with later decay of this region. This involves breakdown of the shell marginal to

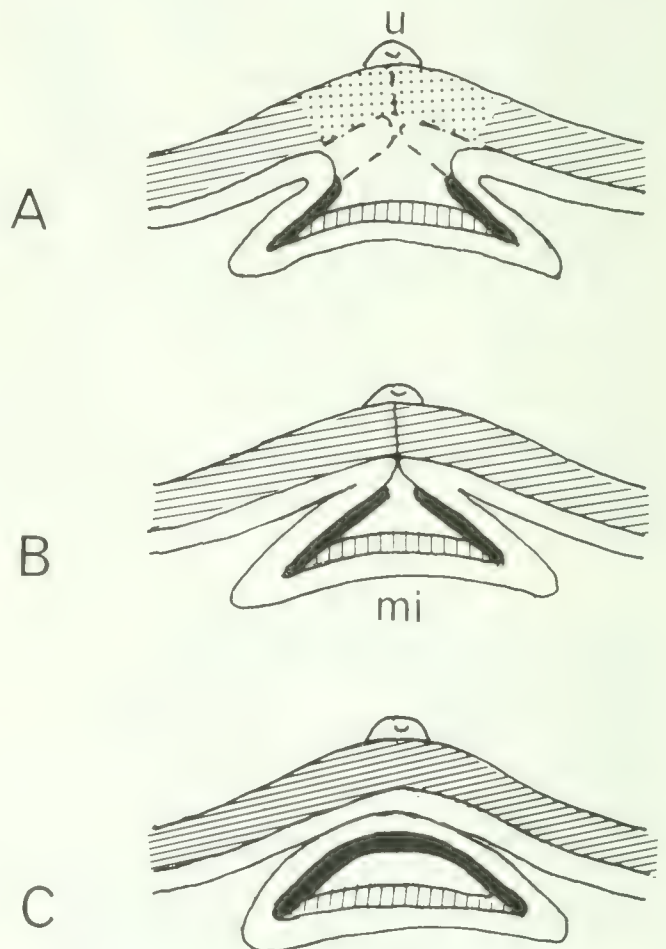

FIG. 7. Diagrams comparing ligamental conditions in:— A, *Pododesmus*, incomplete supradorsal extension followed by decay and exposure of dorsal surface of ligament; B, *Anomia*, complete supradorsal extension with fusion of shell but not of outer layers of ligament; C, *Patro*, complete fusion of ligament as well as shell.

the umbo and of the upper regions of the exposed ligament (described and figured in Yonge (1977) and indicated in Fig. 7A). In *Anomia* (B) the initial supradorsal growth of the mantle margins endures with union of the tissues and so persistence and increase of shell marginal to the umbo. The ligament remains enclosed but the anterior and posterior outer layers do *not* unite; there is always an appreciable gap between them. This is *not* the case in *Patro* (C) (or in *Enigmonia* and *Heteranomia*) where there must be more complete union of the mantle margins resulting in disappearance of the line of union between the supradorsal regions of the shell which persists in *Anomia* (B). Fusion of the outer ligament layers produces the complete compressed oval shown in Fig. 6. The anterior outer ligament layer is appreciably the longer (Figs. 3, 6).

Because not specifically considered previously (Yonge, 1977), the periostracum needs mention. In *Placuna* this becomes separated from the inner and outer layers which form the primary ligament to produce a highly significant secondary ligament. This extends along the new hinge line evolved in association with the change in that genus from byssal cementation to unattached life on mud. It is concerned with alignment of the valves, the primary ligament solely with provision of the opening thrust. But in *Patro*, as in all the Anomiidae, although the periostracum loses contact with the ligament when the mantle margins overarch to unite temporarily or permanently, it retains contact with the margin of the left valve which now extends around the entire periphery, periostracum everywhere forming its outermost layer. There is no production of, or need for, a secondary ligament.

## INTERNAL STRUCTURE

**Comparison between *Anomia* and *Pododesmus*.** Before the smaller differences between *Patro* and *Anomia* can profitably be discussed, more needs to be said about the differences between *Anomia* and *Pododesmus*. There has been some unfortunate confusion here because species of these two genera have been examined from different aspects and never directly compared except incompletely by the writer (Yonge, 1977). *Anomia ephippium* has been the subject of detailed anatomical studies by Lacaze-Duthiers (1854), Pelseneer (1891, 1911) and

Sassi (1905) with further observations on *A. glabra* by Jackson (1890), *A. achaeus* by Pelseneer (1911) and *A. cytaeum* by Tanaka (1955). Structure in this genus has been thoroughly studied but there are no observations in life. All these workers apparently considered species of *Pododesmus* (*Monia*) as essentially similar in internal structure. Separation of the genera was based purely on conchological differences.

The state of affairs is just the opposite with *Pododesmus*. No study of internal anatomy has been made of any species but detailed observations have been made in life of the exposed mantle cavity with figures showing the organs and the course of ciliary currents on ctenidia, palps, mantle and visceral mass in *Pododesmus cepio* (= *Monia machrochisma*) (Kellogg, 1915; Yonge, 1977) and for "*Monia*" *squama* by Atkins (1936) who also examined and figured *Heteranomia squamula* (see below). During the years Atkins worked on these animals at Plymouth she reports never seeing specimens of *A. ephippium* and clearly assumed that it did not differ significantly in structure from "*Monia*." The present author also failed to see living species of *Anomia*, relying in his work on the Anomiacea on preserved specimens of *A. ephippium* from the west of Scotland and of *A. simplex* from the Atlantic coast of North America. Major differences were found between the two genera with *Pododesmus* decidedly the less modified and these were displayed in tabular form (Yonge, 1977, Table 1, p. 495). However the full extent of these differences was not appreciated.

These, largely affecting the distribution of the visceral mass, became apparent in the course of the present study and are best appreciated by reference to Fig. 8. After careful removal from the shell, preserved specimens of small *Pododesmus cepio* and *Anomia simplex* were embedded in 20% gelatin. After some hardening in 10% formalin these were cut horizontally through the centre of the foot and so of the byssal retractor (A, B) with the ventral portion later cut transversely thus passing through the ctenidia and ventral half of the byssal retractor, single or divided (A<sub>1</sub>, B<sub>1</sub>). Differences in the disposal of the visceral mass, especially of the gonad, then became apparent.

Differences in the degree of supradorsal extension have already been noted (Fig. 7, A, B) while the presence of the very large hypobranchial glands separating the ctenidia in

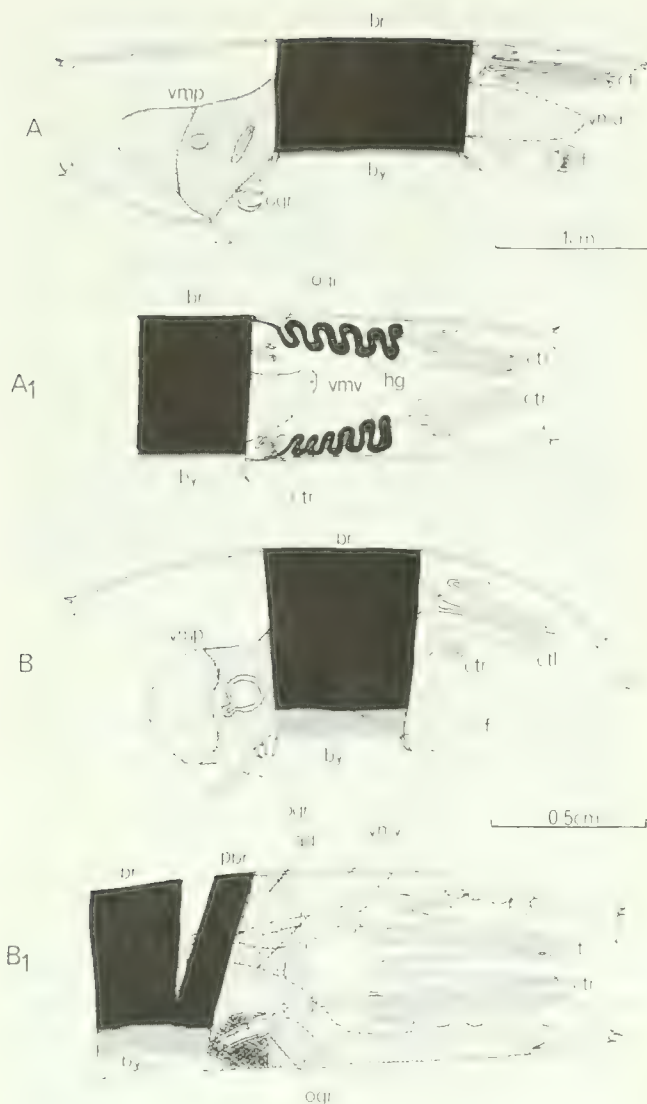

FIG. 8. *Pododesmus cepio* (A) and *Anomia simplex* (B), horizontal (A, B) and transverse ( $A_1$ ,  $B_1$ ) sections through gelatin-embedded specimens (for details see text). Digestive diverticula indicated by fine, and gonad by coarse, stippling.

*Pododesmus* but absent in *Anomia* is further demonstrated in these sections (Figs. 8A $_1$ , hg; 8B $_1$ ). In the latter, also, the ctenidia are seen to be united in the middle line by tissue instead of by the ciliary junctions that connect those of *Pododesmus* for a short distance anterior to the hypobranchial glands. As already figured (Yonge, 1977), the ctenidia which in *Pododesmus*, as in bivalves generally, pass symmetrically to the right and left palps, in *Anomia* and *Enigmonia* are asymmetrically disposed. As shown for the similar *Patro* in Fig. 9, three demibranchs make functional contact with the left (upper) palps and only one with the right palps. This difference also is shown in Fig. 8 (cf. A & B, cti, ctr).

These gelatin sections further reveal that in *Pododesmus* the visceral mass, including the gonads, although laterally much compressed,

remains in the mid-line more or less symmetrically disposed around the byssal apparatus. Held in position between right and left anterior pedal retractors, the mouth continues to be centrally placed, the gut surrounded by the digestive diverticula extending along the posterior surface of the byssal apparatus with the anus as usual projecting at the end of a short rectal extension on the hind surface of the adductor. The very long separate style sac, characteristic of the Anomiacea, extends into the substance of the right mantle lobe. Full effect of lateral compression is shown by the gonads, although remaining approximately the same size, the left gonad extends around the anterior and then ventral surfaces of the byssal apparatus (Fig. 8A, vma;  $A_1$ , vmv), initially passing between the left ctenidium (cti) and the foot (f). The right gonad surrounds the digestive diverticula on the posterior side reaching down below the level of the byssal apparatus and meeting, but not uniting with, the left gonad. The two gonads therefore encircle the central mass of the byssal apparatus on the anterior (vma), ventral (vmv) and posterior (vmp) sides. There is the minimum of change from the normal bilateral symmetry of the Bivalvia.

Conditions are very different in *Anomia*. As described in *A. ehippium* by Lacaze-Duthiers (1854), Pelseneer (1891) and in greatest detail by Sassi (1905) the effects of lateral compression are much greater. The visceral mass is almost entirely concentrated on the posterior side. The gonads are extremely asymmetrical, that on the left greatly reduced and confined to the dorsal side of the byssal apparatus, while that on the right is hypertrophied and extended by way of three connexions from the visceral mass, widely throughout the right mantle lobe. According to Sassi (1905) the former opens dorsally into the left kidney, which encircles the byssal apparatus, the latter into the right kidney postero-ventrally.

Examination of *A. simplex* largely confirms these statements. With loss of the right anterior pedal retractor the mouth moves from the central to a more posterior position (as shown for *Patro* in Fig. 9A, m). The rectum gets caught up with the right gonad so that the anus becomes attached to the right mantle lobe instead of projecting freely into the mantle cavity. As shown in Fig. 8B, the visceral mass does not extend anteriorly between ctenidia and foot. It is confined to the posterior and ventral region (vmp, vmv). It is largely

occupied by the hypertrophied right gonad which extends beyond it mainly into the right, but also to some extent into the left, mantle lobe. The common origin of the gonadal tissue in both lobes, coming from the ventral region of the visceral mass is clearly shown in Fig. 8B<sub>1</sub>. This extension of the right gonad into the left lobe, the left gonad much reduced, represents a unique attempt to re-establish functional bilateral symmetry in these extremely asymmetrical bivalves. There is no evidence that this occurs in *A. ephippium* but this may be because only young animals have been examined. As noted later there is some evidence that penetration into the left mantle lobe is beginning to take place in one specimen of *Patro*, all of which were small. Conditions are very different in other anomiaceans, in *Enigmonia* the left gonad is much the larger (Bourne, 1907) while in *Placuna* it is lost (Hornell, 1909).

**Comparisons between *Heteranomia* and other genera.** Ridewood (1903) in his survey of lamellibranch gills showed that "*Anomia aculeata*, Muller" (= *Anomia squamula* Linnaeus) has unreflected ctenidial filaments. He therefore associated it with *Dimya* in a distinctive order Dimyacea. Its obvious anomiid affinities were later recognized by Winckworth (1922) who erected the genus *Heteranomia* for its accommodation. Recent examination of the filaments in the Dimyidae (Yonge, 1978) shows the ctenidial resemblance to be superficial, the inner filaments of the two sides being united in different manners. In the Dimyidae also, unlike *Heteranomia*, the outer demibranchs make no functional contact with the mantle surface. No work has been done on internal structure in *Heteranomia* but Atkins (1936) described and figured superficial anatomy.

It was earlier shown (Yonge, 1977) that *Heteranomia* resembles *Anomia* in possession of a straight crurum without a right anterior pedal retractor. The rounded byssal notch has more resemblance to that of *Pododesmus* in possession of a very small subcrural groove. Supradorsal fusion of the tissues is complete and with the outer ligament layers united as they are in *Patro*. There is also a symmetrical secondary union of the mantle lobes posterior to the ligament (i.e. unlike *Anomia*, *Patro* and *Enigmonia* where it is asymmetrical) and, as shown by Atkins, this union extends over the greater part of the exhalant region unlike the other genera.

Further examination in the light of the pres-

ent work shows that although the right pedal retractor is lost the mouth remains in much the same position as in *Pododesmus*; there is a large left anterior retractor as figured by Atkins. The gonads are disposed essentially as in *Pododesmus* without any intrusion of the right gonad into the mantle. A unique feature is the enclosure of the basal half of the foot in the left gonad. This probably reduces pedal activity in cleansing and may be correlated with the greater sweep of the unreflected ctenidia. The adductor is smaller than in other anomiids, its scar, as noted by Winckworth (1922), blending with that of the very much larger, undivided byssal retractor.

In brief, in its anatomy *Heteranomia* has affinities with *Pododesmus* (visceral mass, position of mouth), with *Anomia* (straight crurum, complete supradorsal fusion of tissues), with *Patro* (union of outer ligament layers) together with features peculiar to itself (unreflected ctenidia, enclosure of base of foot within right gonad). This is a very well defined genus.

**Structure in *Patro australis*.** The general appearance after removal from the shell and viewed from the right (under) and left sides is shown in Fig. 9A, B. Structure is similar to that of *Anomia* and *Enigmonia* with the three demibranchs associated with the left labial palps (pl), and the mouth (m) well over on the right side following loss of the right anterior pedal retractor. The anus (a) at least in this small specimen (because conditions might change with growth) is not adherent to the right mantle lobe. The left anterior pedal retractor (aprl) is larger than in *Anomia* spp. The visceral mass is confined to the posterior and ventral sides of the central byssal apparatus with the right gonad extending widely throughout the right mantle lobe. In this the attenuated style sac (cs) describes a complete circle. Only in one, rather larger specimen, was there some indication of extension of this gonad into the left mantle lobe.

In the absence of a pericardium, the ventricle (v) with the asymmetrical entering auricles (aur, aul) are freely exposed. Viewed from the right side (B) the four muscles producing the scars shown in Fig. 3 are apparent. As throughout the Anomiacea, only a small section of the adductor is composed of non-striated catch muscle (adc). Adduction is achieved by way of the much larger divided byssal retractor (br, pbr) the quick muscle of the adductor (adq) being responsible for ejection of pseudofaeces by way of the somewhat

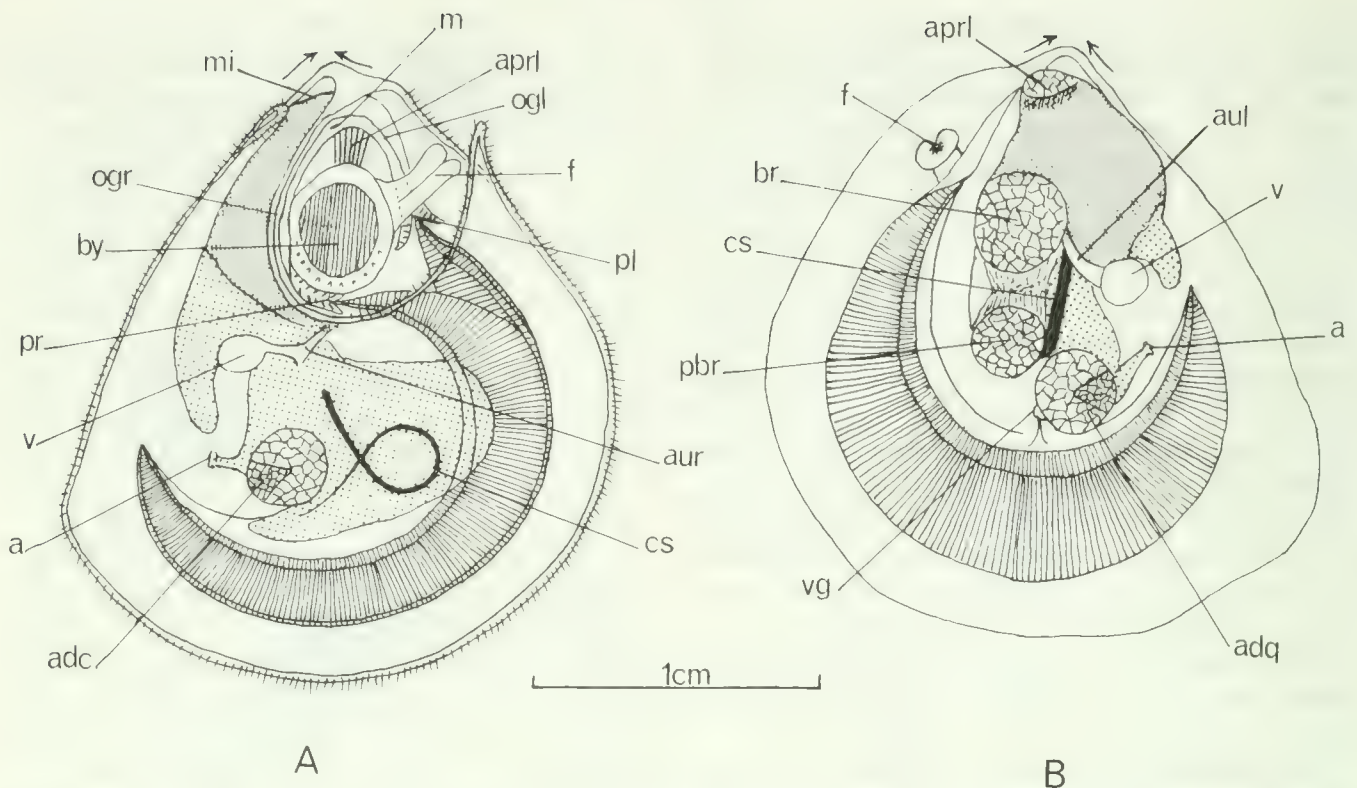

FIG. 9. *P. australis*, specimen removed from shell and viewed A, from right (under) side and B, from left side. Arrows indicate supradorsal extension at each end of mantle isthmus resulting in fusion above. Digestive diverticula and gonad indicated as before.

raised posterior region of the mantle cavity. Although only seen after preservation when much contracted, the foot does appear to be smaller than in *Anomia* sp. and so of possibly less importance in cleansing.

The major differences between *Patro* and *Anomia* are conchological, the prismatic character of the right valve, the smaller and more open byssal notch (Fig. 5), the complete union of the outer ligament layers (Fig. 7C) and the uneven convexity of both valves (Fig. 6). The area of byssal attachment is somewhat smaller but not less calcified. This, together with the obvious ability of the valves to conform to irregular surfaces, supports the opinion of Beu (1967) that species of this genus are adapted for life on more irregular surfaces than those of other anomiid genera. A greater capacity for dealing with sediment is also indicated. Thus, although regarded as a subgenus of *Anomia* in the *Treatise on Invertebrate Paleontology*, there is good evidence for regarding *Patro* as a distinct genus, very closely related to *Anomia* but with its species capable of exploiting the possibilities of life on more irregular substrates and under more turbid conditions.

#### ACKNOWLEDGEMENTS

Thanks are due to Dr. Winston Ponder, Curator of Molluscs at the Australian Mu-

seum, Sydney, for supply of the specimens here studied. The writer has also to thank his wife for much technical and secretarial help, the Natural Environment Research Council for financial assistance (Grant GR3/1380) and Professor J. M. Mitchison F.R.S. for provision of facilities in the Department of Zoology, University of Edinburgh.

#### LITERATURE CITED

- ATKINS, D., 1936, On the ciliary mechanisms and interrelationships of Lamellibranchs. Part 1. Some new observations on sorting mechanisms in certain lamellibranchs. *Quarterly Journal of Microscopical Science*, 79: 181-308.
- BEU, A. G., 1967, Notes on Australasian Anomiidae (Mollusca, Bivalvia). *Transactions of the Royal Society of New Zealand*, 9: 225-243.
- BOURNE, G. C., 1907, On the structure of *Aenigma aenigmatica*, Chemnitz: a contribution to our knowledge of the Anomiacea. *Quarterly Journal of Microscopical Science*, 51: 253-295.
- GRAY, J. E., 1847, In J. B. JUKES, *Narrative of the surveying voyage of H.M.S. Fly*, Vol. 2, Appendix, p. 362. Boone, London.
- GRAY, J. E., 1849, On the species of Anomiidae. *Proceedings of the Zoological Society of London*, 16: 113-124.
- HORNELL, J., 1909, Report upon the anatomy of *Placuna placenta*, with notes upon its distribution and economic uses. *Report Marine Zoology Okhamandal*, 1: 43-97.



- IREDALE, T., 1939, Mollusca. Part 1. *Scientific Reports, Great Barrier Reef Expedition (1928–29)*, *British Museum (Natural History)*, 5: 209–425.
- JACKSON, R. T., 1890, Phylogeny of the Pelecypoda, the Aviculidae and their allies. *Boston Society of Natural History, Memoir* 4: 277–400.
- KELLOGG, J. L., 1915, Ciliary mechanisms of lamellibranchs with descriptions of anatomy. *Journal of Morphology*, 26: 625–701.
- LACAZE-DUTHIERS, H., 1854, Mémoire sur l'organisation de l'anomie (*Anomia ephippium*). *Annales des Sciences Naturelles, Zoologie.*, ser. 4, 2: 5–35.
- PELSENEER, P., 1891. Contribution à l'étude des Lamellibranches. *Archives de Biologie*, 11: 147–312.
- PELSENEER, P., 1911, Lamellibranches de l'expédition du Siboga. Partie anatomique. *Siboga-Expeditie*, Monogr. 53a: 1–125.
- RIDEWOOD, W. G., 1903, On the structure of the gill of the Lamellibranchia. *Philosophical Transactions of the Royal Society of London*, ser. B, 195: 147–284.
- SASSI, M., 1905. Zur Anatomie von *Anomia ephippium*. *Arbeiten aus dem Zoologischen Institute, Wien*, 15: 81–96.
- TANAKA, J., 1955, Anatomical observations on *Anomia cytaeum* Gray. *Bulletin of the Marine Biological Station Asamushi*, 7: 109–119.
- TAYLOR, J. D., KENNEDY, W. J. & HALL, A., 1969, The shell structure and mineralogy of the Bivalvia. Introduction. Nuculacea-Trigonacea *Bulletin of the British Museum (Natural History), Zoology*, Suppl. 3: 1–125.
- WINCKWORTH, R., 1922, Note on the British species of *Anomia*. *Proceedings of the Malacological Society of London*, 22: 23–26.
- YONGE, C. M., 1977, Form and evolution in the Anomiacea—*Pododesmus (Monia)*, *Anomia*, *Patro*, *Enigmonia* (Anomiidae); *Placunanomia*, *Placuna* (Placuniidae fam. nov.). *Philosophical Transactions of the Royal Society of London*, ser. B, 276: 453–523.
- YONGE, C. M., 1978, On the Dimyidae with special reference to *Dimya corrugata* Hedley and *Basiliomya goreau* Bayer. *Journal of Molluscan Studies*, 44: 357–375.



## EPISODIC GROWTH IN GASTROPODA

Robert M. Linsley<sup>1</sup> and Mahdokht Javidpour<sup>2</sup>

### ABSTRACT

A study of the growth lines of shells from the families Cassidae, Cymatiidae, Bursidae and Muricidae indicates that shell growth in these forms is not a continuous event, but occurs in abrupt episodes of growth. During these growth spurts the animal may be very vulnerable and possibly the animal's behavior is modified to reduce the vulnerability. The growth of *Cassis* apparently represents the most rapid deposition of aragonite to be found in the phylum Mollusca.

### INTRODUCTION

The helical form has been adopted by many different groups of organisms, primarily because it allows growth to be continuous without modification of overall form (Raup, 1966; Thompson, 1917). Most frequently this form will be functional without modification throughout the adult life of the organism. However, a few gastropod genera have evolved shell forms which are not continuously repeating, but are functional only at periodic stages during their growth. In some instances (i.e. *Biplex* Perry) the snail has even abandoned the helical form and evolved a compressed variation of a helix. In other instances (*Cymatium* Röding and *Distorsio* Röding) the helical form is retained, but the axis of coiling changes for each growth episode, resulting in a shell with very distorted volutions. Still others (*Phalium* Link, *Cassis* Scopoli, *Bursa* Röding and many Muricidae) retain a regular helical coil, but interrupt the helix with thickened, reflexed, varix-forming apertural modifications. The functional forms repeat themselves at various intervals in these genera (Wrigley, 1934). In *Murex* the functional form frequently repeats about every one-sixth or one-third of a volution, although this is an extremely variable feature in this family. In *Biplex* repetition is every one-half volution, in most species of *Cassis*, *Cymatium* and *Distorsio* approximately every two-thirds volution (Laxton, 1970). Shell formation must thus occur in these amounts as the intermediate forms are non-functional.

In a limited sense, shell accretion in these mollusks somewhat resembles growth of the

arthropods. Firstly, the forms are discontinuous from one stage to another and secondly, while the animal is secreting the earliest shell layers, it is very vulnerable to predation. It is anticipated that many of these animals seek protection by burial during these unprotected stages, only reemerging when the shell has been sufficiently thickened to be of significant protective value. Because of this vulnerability, many have adopted aperture-edge modifications such as the shell reflected back on itself (Fig. 1) or greatly flared to strengthen that weakest portion of the shell (Vermeij, 1976, 1977). Thirdly, it might prove interesting to investigate the physiology of these mollusks for we anticipate that there must be storage of calcium salts in the mantle in preparation for the sudden growth needs found in these forms. It is presumed that aragonite deposition is very rapid during the early periods of new growth.

### DESCRIPTION OF EXAMINED THIN SECTIONS

We have examined thin sections of most genera that have pronounced varices. These include the genera *Cassis* Scopoli, *Cymatium* Röding, *Distorsio* Röding, *Biplex* Perry and various muricids. Thin sections of all specimens examined show at least superficially the expected shell layers of periostracum, ostracum and hypostracum. However the growth lines do not cross the shell layers at an oblique angle as they do in most mollusc shells. Rather the growth lines all parallel the outermost surface of the shell as well as the

<sup>1</sup>Department of Geology, Colgate University, Hamilton, New York 13346, U.S.A.

<sup>2</sup>University of Teacher Education, Tehran, Iran.

boundaries between various shell layers. From this evidence we conclude that shell-secretion in varix-bearing gastropods is not a constant process of accretion with the mantle acting as a moving conveyor belt and altering its secretion from periostracum at the mantle margin to the various calcareous deposits as the cells move away from the margin. Instead we suggest that shell secretion is a very abrupt episode of growth. The nature of the growth line suggests that the animal extends quite far from the old aperture whereupon the mantle secretes a broad layer of periostracum and then follows it with the various calcareous layers. Thus the change from ostracum to hypostracum is not a matter of topology for a single cell but an abrupt secretory shift for the entire mantle.

Some of the genera studied offer further insight into the nature of this episodic growth so a genus by genus discussion seems appropriate.

## DESCRIPTION OF EXAMINED SPECIES

### Genus *Cassis* Scopoli (Figs. 1, 2)

We have studied sections of the shells of three species, *Cassis tuberosa* (Linné), *C. flammea* (Linné) and *C. madagascariensis* (Lamarck). These shells were collected in the Bahamas in January, 1975. The helmets are large shells which have modified their basic helical shell form into a subtriangular shape by the formation of a thickened outer lip and a thick parietal inductura to form a flattened shield-like area around the aperture. This provides the shell with considerable stability on the substrate even when the animal is retracted into its shell. This sub-triangular shape is further emphasized in many species by the formation of a large "dorsal" node or row of nodes directly opposite the aperture. The aperture is periodically abandoned and remains in the older portions of the shell as a varix. Typically the varices are about two-thirds of a volution apart. Thus, a single growth episode must span two-thirds of a volution very quickly in order to remain functional.

Since some helmets are very large (in excess of thirty centimeters long) this initial deposit of aragonite may represent the greatest and most rapid secretion of calcareous material in the phylum Mollusca.

*Cassis* has developed one feature relating to growth which we believe may be unique to the genus. Not only does it secrete two-thirds of a volution of the outer lip in one episode, but it also secretes one-third volution of a new inner whorl at the same time. This inner whorl is separated from the preceding whorl through much of its growth, thus forming a disjunct inner surface which completely envelopes the old varix and old siphon in an interior space. Since specimens of *Cassis* frequently possess a lush growth of epibionts this secretion of a new inner whorl covers over these encrustations and shields the body of the gastropod from them during the abrupt growth spurt.

We believe that *Cassis* buries itself in sand during the formation of the new shell, but can offer only indirect evidence to support this belief. When fresh shells are cut open this inner space between the new inner surface and old shell is filled with sediment which suggests that it may have been enclosed there at the time of formation of the new shell layer. Although this supports our contention that this growth takes place while *Cassis* is buried, this space is open to the exterior through an opening (a "pseudoumbilicus") behind the siphonal canal and the most recent varix. It is, therefore, possible that sand entered this cavity after its formation, but the area is so tightly packed with similar looking sediment that we suspect the sand to be a primary feature. One specimen was given to us by Porter Kier (National Museum of Natural History, Washington, D.C.) who found it buried in sediment in the Caribbean. The last two thirds of a volution are literally paper-thin (0.5 mm) and was probably just thickening its shell prior to re-emergence.

Rhoads & Morse (1971) have pointed out how burial in anoxic sediments can inhibit calcium deposition in mollusks. Obviously this defensive behavior would only be possible for animals whose shell form would allow burial and who live in areas where the sediments are well oxygenated. *Cassis* frequently buries into the sediment as it searches for echinoids, and lives in areas of coarse oolitic sands which would presumably be well oxygenated. Therefore, we see burial during the growth phase as a viable protective behavior for *Cassis*, but certainly not for all other varix-forming gastropods.

It is presumed that *Cassis* emerges from the sand while the shell is still moderately thin and thus the formation of a thickened outer lip

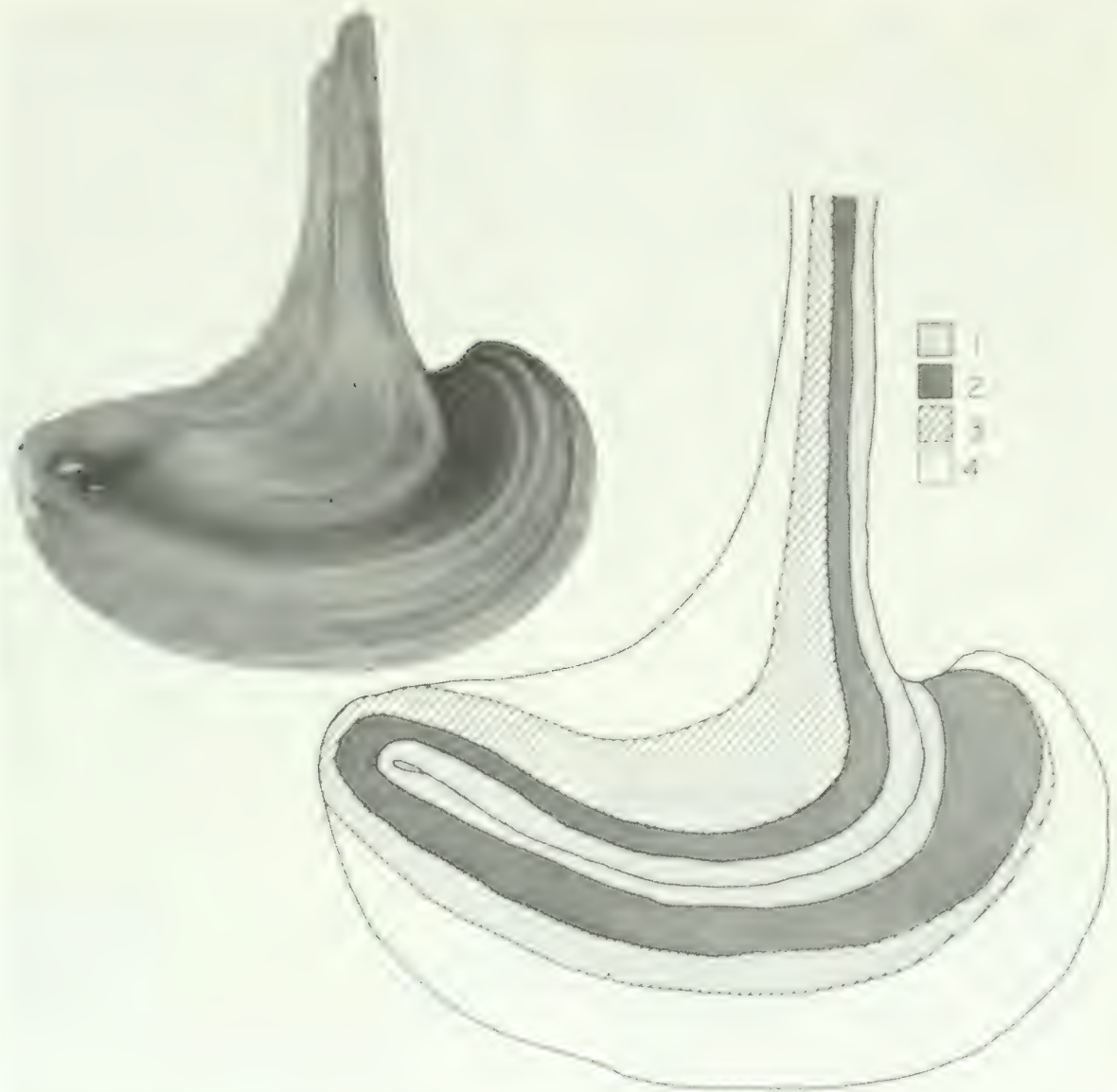

FIG. 1. Transverse thin section and schematic interpretation through the outer lip of *Cassis tuberosa* (Linne), showing reflection of the shell layers to form a double thickness of shell.

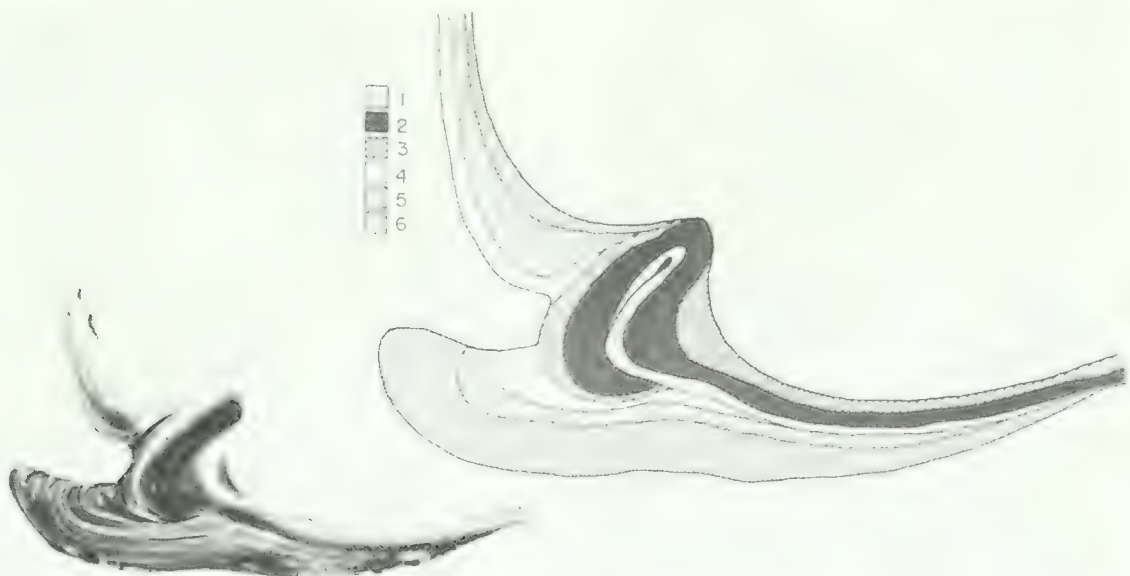

FIG. 2. Transverse thin section and schematic interpretation through the parietal shield of *Cassis tuberosa* (Linne). In the reconstruction shell layers 1–3 are of the varix (the outer lip of the preceding resting phase). Layers 4–6 are shell layers of the final volution with the layers above the varix belonging to the final whorl, while those below the volution are part of the parietal shield.

would help protect the animal from predation, particularly by crabs (Vermeij, 1976, 1977). At the mantle edge where the new outer lip will be formed, the mantle reflects back on itself to secrete a double thickness of shell material. The outer lip maintains this growth style throughout the existence of the lip, constantly accreting a double shell layer at the outer lip at the same time that the parietal shield is accreting (Figs. 1, 2). An examination of the outside of the shell reveals features that resemble growth lines, but close inspection shows they do not possess the imbricated structure normally associated with growth lines, but instead are rounded, confluent structures that we call "pseudo-growth lines."

Genus *Cymatium* Röding  
(Fig. 3)

*Cymatium echo* (Kuroda & Habe) has only a single varix preceding the thickened outer lip (Laxton, 1970). In the area between the varix and the outer lip the periostracum is extended into lines of hair-like extensions six times. The lines of periostracal hairs are close together near the varix and progressively more widely spaced as the outer lip is approached. From this we infer that the periostracal layer is formed by six abrupt extensions of

the mantle with the periostracal hairs delineating each extension. We would expect a thin layer of calcareous material to be deposited under the periostracum to rigidify it soon after the deposition under the periostracum. This process would then be repeated after short intervals, each periostracal secretion being broader than the preceding one, until the final extension is more than a quarter of a volution. Harold Lewis (personal communication, 1977) has reported seeing individuals of *Cymatium* in this final stage and reports that the periostracal layer was flexible enough to be pulled across the aperture to partially close it off.

Nevertheless, examination of thin sections of *Cymatium echo* demonstrates that these short calcareous layers of these subepisodes are tissue thin, for they are not visible in cross-section. Again, the major impression in the cross-sectional view (Fig. 3) are thin sheet-like laminae that parallel the outer surface of the shell, showing that, for the most part at least, shell material is being deposited in continuous sheets over two-thirds of a volution with thin extensions past the preceding varix.

Varix formation is quite different from that found in *Cassis*. The outer lip is formed by an outward bulge of the outermost shell layer and is thickened by subsequent addition of thicker layers of aragonite (Fig. 3). It is ap-

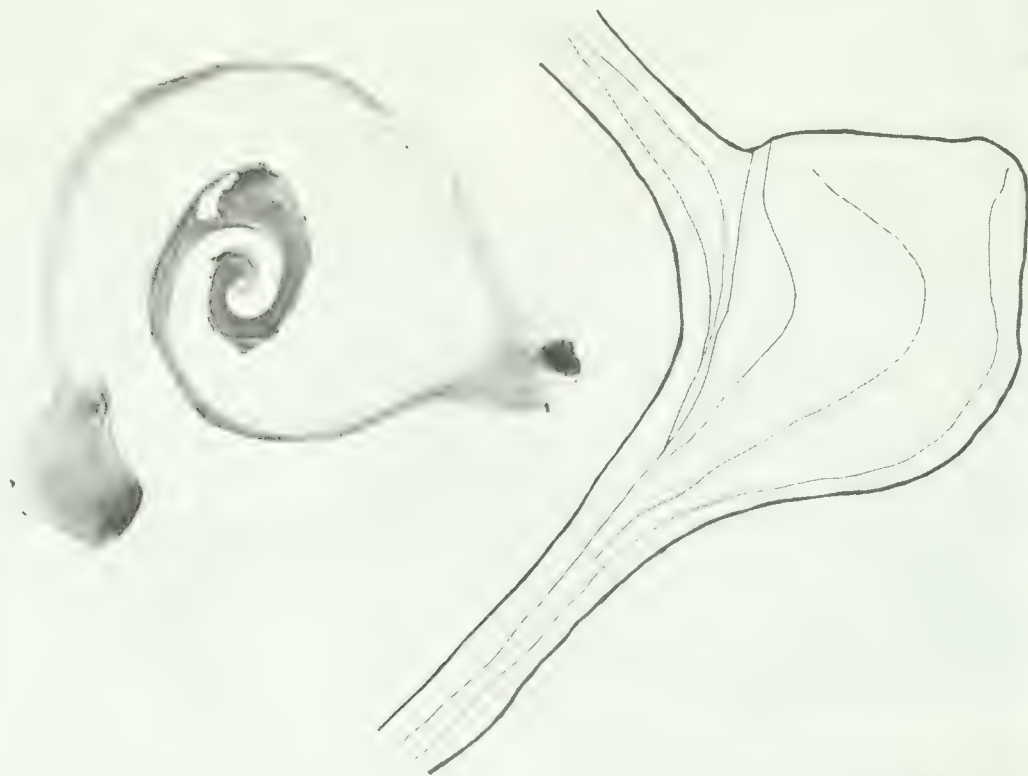

FIG. 3. Transverse thin section of *Cymatium lotorium* Linne and schematic presentation of the varix. The schematic presentation traces six well-defined growth lines within the varix and subsequent whorl.

parent that aragonite is deposited in the area of the thickened outer lip long after it has ceased elsewhere.

Many species of *Cymatium* have morphologic features of the shell which are non-functional except at periodic intervals when the outer lip is restored. In all species examined, the varices (and thus the major growth episode) are roughly every  $240^\circ \pm 15^\circ$ . The major non-continuous feature in many species, such as *Cymatium femorale* (Linné), *C. lotorium* (Linné) and *C. hepaticum* (Röding) consists of an inclination and rotation of the axis of coiling relative to the original axis of coiling. This strange growth mode allows the plane of the aperture to converge upon being parallel to the original axis of coiling. This lowers the center of gravity of the shell (Linsley, 1977) and assures that the modest spire does not extend very high above the substrate. These animals live on unconsolidated sediments, where the modest spire would provide a good lever for dislodging the specimens if it protruded upwards too high above the substrate.

Genus *Distorsio* Röding  
(Fig. 4)

*Distorsio* shows many features that are similar to *Cymatium*. The growth episodes constitute two-thirds of a volution and are accompanied by inclination and rotation of the shell axis for each depositional event. Intermediate growth positions would obviously be non-functional, with the spire held much too high off the substrate, presenting a high center of gravity and easy dislodgement of the animal from the soft substrate. The presence of periostracal hairs again suggests the occurrence of subepisodes (about twenty are suggested in *D. reticulata*). A careful examination of the shell beneath the periostracum does not show any reflections of the subepisodes, and examination of the thin sections (Fig. 4) again suggests that shell deposition occurred in sheets parallel to the outer surface of the shell.

Varix formation is again distinctive in *Distorsio*. The initial formation of the outer lip oc-



FIG. 4. Transverse thin section and schematic interpretation of *Distorsio anus* (Linne). Shell layer 1 in the schematic diagram represents the former growth phase and varix, while layers 2 and 3 represent the final two-thirds of a volution showing the method of formation of the outer lip and the parietal shield deposited over the varix.

curs by a figure "S" flaring of the outermost (ostracal) shell layers (Fig. 4). Subsequent shell deposition, primarily of the hypostracal shell layers, thickens the outer lip disproportionately, causing an inward bulge of shell material at the position of the future varix.

Genus *Biplex* Perry  
(Fig. 5)

Our understanding of this genus is based on examination of the shell and thin sections of a single species, *Biplex perca* (Perry). This is an unusual species in that it has completely abandoned the logarithmic growth form in favor of a very flattened approximation thereof (Fig. 5). This flattening is emphasized by the construction of flanges near the position of the outer lip which results in varices every 180°. Nowhere in the class Gastropoda is there a shell that is so patently non-functional except at the 180° positions. Examination of the thin sections again suggests that growth is indeed episodic, and that 180° of shell is secreted in sheets and then progressively thickened inwards.

Varix formation is accomplished by a blade-like outpouching of the outer shell layer (Fig. 5) which results in sub-parallel layers of shell enclosing a hollow core. It is presumed that the mantle initially occupies this core area. As new shell layers are deposited in this space the mantle retreats more rapidly than shell deposition occurs with the consequence that hollow spaces are left between subsequent infilling shell layers.

The resultant form of this shell is well adapted to lying flat on a soft substrate with the flanges disposed to protect the protruding soft parts and at the same time resist having the shell sink into the ooze.

Family Muricidae da Costa  
(Figs. 6, 7)

The majority of the members of the family Muricidae have episodic growth. Those that do are typically characterized by varices, usually placed every third of a volution or every sixth of a volution. Abrupt growth is attested to by the fact that of three hundred specimens of *Chicoreus florifer* (Reeve) in the Colgate collection, every one has a fully formed outer lip, some very thin, some fully filled in with subsequent inner deposits. None of the three hundred specimens was collected with a lip formed in between varices.

The growth rates of a number of muricids have been studied under laboratory conditions and certainly the intermittence of the growth process has been noted. Spight & Lyons (1974) plotted the growth of juveniles of *Ceratostoma foliatum* (Gmelin) and noted growth ceased in between varix formation in more mature individuals. MacKenzie (1961) reported that immature individuals of *Eupleura caudata* (Say) deposited one-half volution in three weeks and then spent four weeks reinforcing it. Inaba (1967) observed *Chicoreus asianus* for sixty days and observed that the snail grew less than half the time it was under observation and that it fasted while making all modifications to its shell. *Pterynotus trialatus* (Sowerby) and *Forreria belcheri* (Hinds) were also observed to undergo episodic growth by MacGinitie & MacGinitie (1949). And lastly, Abbott (1954) notes that some species of *Murex* require two days to grow the shell between varices.

Apparently, muricids which have been observed under laboratory conditions do not attempt to hide during these growth periods. Indeed, we would not expect them to under



FIG. 5. Transverse thin section and schematic representation of *Biplex perca* Perry. Note the flattened helical form and the mode of varix formation.



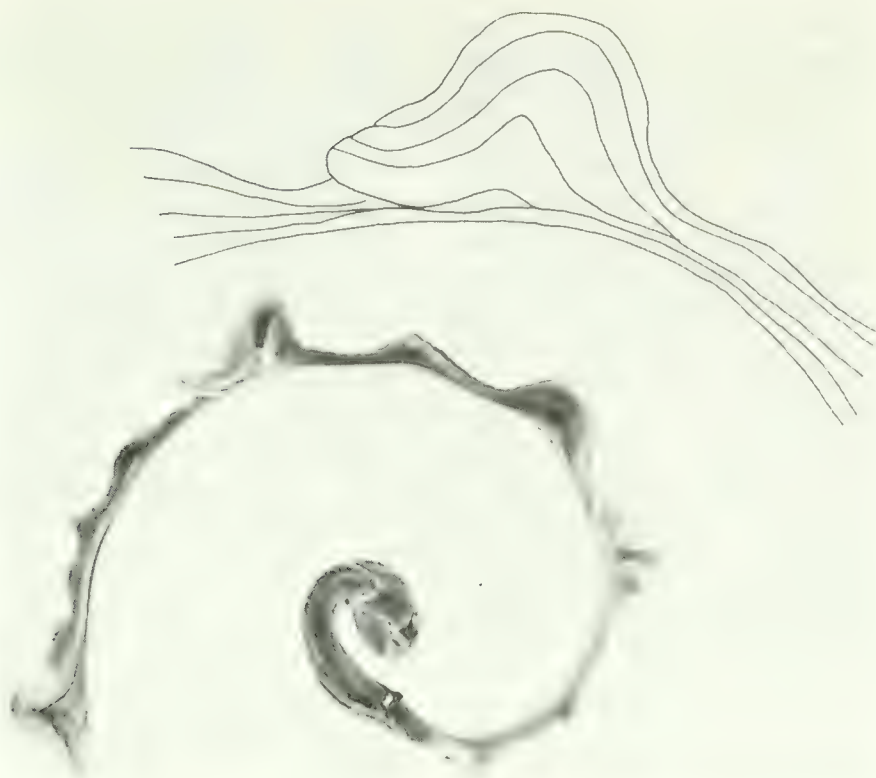

FIG. 6. Transverse thin section of *Phyllonotus pomum* (Gmelin) and schematic diagram of varix.

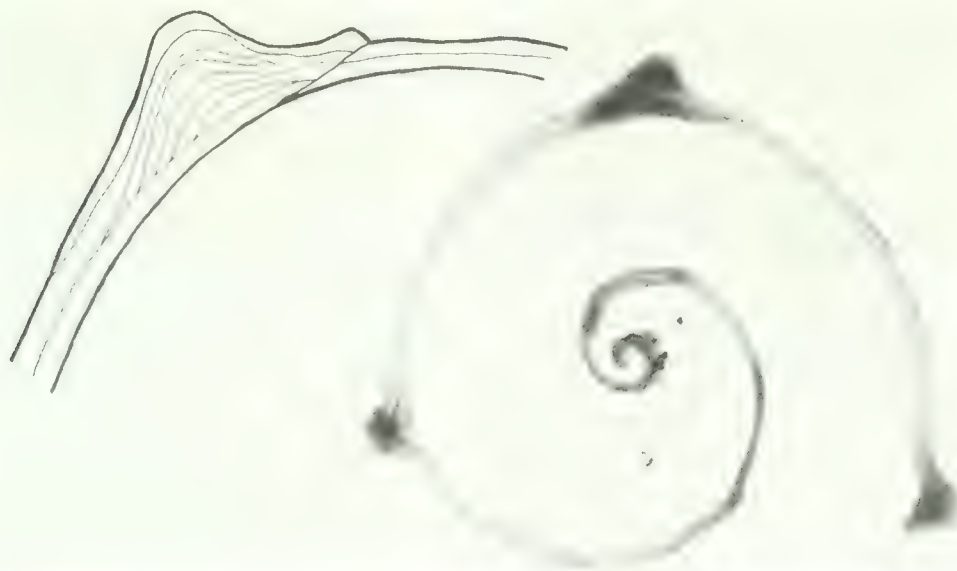

FIG. 7. Transverse thin section of *Murex troscheli* (Lischke) and schematic diagram of varix.

natural conditions either. For one thing, many muricids, such as those with spires or extensive varices have shell forms that would be poorly suited to a burrowing life mode. Secondly, since many muricids live in muds which may be anoxic, burrowing might well inhibit calcite deposition (Rhoads & Morse, 1971).

Thin sections were made of *Chicoreus florifer* (Reeve), *Murex troscheli* (Lischke), *Chicoreus axicornis* (Lamarck), *Phyllonotus pomum* (Gmelin), *Murex tribulus* (Linné),

*Chicoreus ramosus* (Linné), *Marchia pellucidus* (Reeve), and *Pteropurpura macroptera* (Deshayes). All are similar in that they show aragonite deposition in layers paralleling the outer surface from which it is inferred that original growth is very rapid, extending the whorl 1/3 or 1/6 revolution. This phase is then followed by continued thickening of existing shell until the next growth spurt is commenced.

With a few exceptions, the formation of the

outer lip of the muricids follows the general plan found in *Cymatium*. In most instances (i.e. *Phyllonotus*) the outermost shell layer forms an initial outward bulge which is then thickened by the addition of layers inside of the initial layer. A variation on this general theme is found in *Pteropurpura macroptera* where the initial shell layer merely flares outward without the inward bend (Spight & Lyons, 1974). Subsequent deposition merely parallels this initial form to cause the resulting flange. *Pterynotus pellucidus* combines these two techniques to form its outer lip. The initial deposits resemble those of *Pteropurpura macroptera* in having an outward flare. After this portion is thickened slightly a second phase is initiated where there is now an inward bend more reminiscent of that found in *Murex pomum*.

#### PRESUMED CONSEQUENCES OF EPISODIC GROWTH

We suggest that there may well be physiological and behavioral adaptations in organisms that utilize episodic growth. At the very least we expect feeding to cease while modifications are made to the shell, as has been reported for *Chicoreus asianus* (Inaba, 1967). Where possible, we expect the animals will seek protection during this phase of vulnerability either by pulling the periostracum across the aperture (in *Cymatium*) or by burial (in *Cassis*).

We also suggest that there may well be a buildup of calcium salts in the mantle prior to the growth episode in preparation for the need for quick deposition of large sheets of aragonite. Lastly, there may be some adaptation of the columellar retractor inside relating to the growth episode. It would be of interest to know if muscle migration is abrupt and discontinuous so as to be in the most advantageous placement during the long periods of no growth or whether it migrates steadily throughout the quiescent phase.

#### SUMMARY AND CONCLUSIONS

Within the class Gastropoda, a number of species have evolved shell forms characterized by varices. These varices not only represent "resting phases" in shell growth, but pro-

vide the shell with a geometry that makes intervarical shell forms non-functional. Examination of thin sections of these shells indicates that growth from one varix to the next is indeed very rapid, for growth lines parallel the outer shell surface as though sheets of aragonite were deposited, each underlying the preceding sheet. It is further inferred that each growth episode probably consists of sub-episodes so that, though growth from one varix to the next is very rapid, it does not occur in a single event. It is also suggested that this growth mechanism must necessitate physiological and behavioral adaptations by these organisms.

#### LITERATURE CITED

- ABBOTT, R. T., 1954, *American Seashells*. New York: Van Nostrand, xiv and 541 p.
- INABA, A., 1967, Growth of *Chicoreus asianus*. *Venus*, 26: 5-7.
- LAXTON, J. H., 1970, The relationship between the number of varices and total shell length in some New Zealand Cymatiidae (Gastropoda: Prosobranchia) and its ecological significance. *Veliger*, 13: 127-134.
- LINSLEY, R. M., 1977, Some "laws" of gastropod shell form. *Paleobiology*, 3: 196-206.
- MACGINITIE, G. E. & MACGINITIE, N., 1949, *Natural History of Marine Animals*. New York: McGraw Hill, 473 p.
- MACKENZIE, C. L., Jr., 1961, Growth and reproduction of the oyster drill *Eupleura caudata* in the York River, Virginia. *Ecology*, 42: 317-338.
- RAUP, D. M., 1966, Geometric analysis of shell coiling: general problems. *Journal of Paleontology*, 40: 1178-1190.
- RHOADS, D. C. & MORSE, J. W., 1971, Evolutionary and ecologic significance of oxygen-deficient marine basins. *Lethaia*, 4: 413-428.
- SPIGHT, T. M. & LYONS, H., 1974, Development and functions of the shell sculpture of the marine snail *Ceratosstoma foliatum*. *Marine Biology*, 44: 77-83.
- THOMPSON, D'A. W., 1917, *On Growth and Form*. Cambridge, xv and 793 p.
- VERMEIJ, G. J., 1976, Interoceanic differences in vulnerability of shelled prey to crab predation. *Nature*, 260: 135-136.
- VERMEIJ, G. J., 1977, Patterns in crab claw size: the geography of crushing. *Systematic Zoology*, 26: 138-151.
- WRIGLEY, A., 1934, English Eocene and Oligocene Cassididae, with notes on the nomenclature and morphology of the family. *Proceedings of the Malacological Society of London*, 21: 108-130, pl. 15-17.

THE GIANT WHITE CLAM FROM THE GALAPAGOS RIFT,  
*CALYPTOGENA MAGNIFICA* SPECIES NOVUM

Kenneth J. Boss and Ruth D. Turner

*Museum of Comparative Zoology, Harvard University,  
Cambridge, Massachusetts 02138, U.S.A.*

ABSTRACT

During DSRV/ALVIN cruises to the Galapagos Rift and the East Pacific Rise in 1977 and 1979, dense populations of large white clams were found associated with the thermal vents. On the basis of shell characters, M. Keen identified them as a species of *Calyptogena*, family Vesicomidae. These clams exceed 260 mm in length and are the largest known living members of this family, though some fossil vesicomids are comparable in size. Morphologically they closely resemble *C. pacifica* and *C. kilmeri*, the only species of *Calyptogena* which have been studied anatomically. Specimens ranging from 34.5 to 263 mm in length obtained during the 1977 and 1979 cruises are here described as a new species, *C. magnifica*, most closely related to *C. elongata* from off the coast of southern California, a species described by Dall on the basis of shells only.

In Appendix 1, C. Berg and R. D. Turner describe living specimens, noting the pink-purple iridescences of the mantle, the yellow-brown, wrinkled periostracum, the short siphons which do not extend beyond the valves, and the large iridescent-pink protrusible foot. The red blood pigment, a haemoglobin, gives the visceral mass a red appearance. The gills in large specimens are mottled red-brown with purple lines on the ventral margin while in small specimens they are a uniformly pinkish cream.

In Appendix 2, K. Boss provides an annotated checklist of ten fossil and seven living species of *Calyptogena*. One species is from the eastern Atlantic, off Africa; two are from the western Caribbean and 14 from the eastern and northern Pacific and Peru to Japan.

INTRODUCTION

Lonsdale (1977) reported unusually dense macrobenthic communities, including large white clams, associated with thermal anomalies along the deep-sea spreading centers of the Galapagos Rift. Samples from these peculiar ecosystems were obtained during DSRV/ALVIN Cruise 90 (Corliss et al., 1979) and during a biological investigation (ALVIN Cruise 102, legs 8 and 9) in January-February 1979 (Grassle et al., 1979) and Cruise 103, leg 5, in November-December 1979. The unusual habitat and organisms have received considerable attention in the public media, including an illustrated popular account by Corliss & Ballard (1977) and Ballard & Grassle (1979).

The big white clams, which provided the nickname "Clambake" for one of the hot vents, caused great excitement among oceanographers and marine biologists. They were referred to the genus *Calyptogena* by

Keen (1977a, b). The large size (all specimens from the 1977 cruise were about 200 mm in length) and unusual habitat of these clams led us to believe that they represented a new species closely related to *C. modioliforma* (Boss), a species from the Caribbean based on a unique specimen, and *C. elongata* Dall from off southern California known only from three specimens all less than 50 mm in length.

When DSRV/ALVIN revisited the Galapagos Rift in 1979, several smaller specimens were collected which produced a growth series ranging from 34.5 mm in length (which is smaller than the type-specimen of *C. elongata*) to 240 mm in length. Though the type-locality of *C. elongata* is some hundreds of miles north of the northernmost specimens collected by ALVIN, these widely separated populations show relatively minor morphological differences in the shells except the size of the valves and the ligament.<sup>1</sup> The discovery of new populations of *Calyptogena* as

<sup>1</sup>Turekian, Cochran & Nozaki (1979) have calculated the age of the shells of this species to be between 6.5 and 830 years old.

exploration of the East Pacific Rise progressed northward (Fig. 13), and the variability shown by many species in this genus has led us to consider the 'hot vent' clams as a new species most closely related to *C. elongata*. This is a tentative assignment for, though we are secure in our assignment on the basis of the shells, the anatomy of the soft parts of *C. elongata* and other species of *Calyptogena* is essential before we can positively determine the relationship of these species.

## SYSTEMATICS AND DESCRIPTIONS

### Family Vesicomysidae Dall & Simpson 1901

*Description.* Shell of adults from less than 10 to over 200 mm in length, ovate to elongate in outline, inequilateral and equivalve, usually without gape; shell substance aragonitic with homogeneous inner and outer layers without tubulations or cross-lamellations; periostracum present, usually well developed; umbos prosogyrous, sometimes partially enrolled; lunule and escutcheon variable, present or absent. Ligament external, opisthodontic, and parivincular. Dentition with variably formed, more or less subumbonal cardinal teeth diverging or subundulate beneath the beaks. Adductor muscle scars subequal and with pedal retractor scars at their dorsal inner margin. Pallial line sometimes broadened, usually entire and sometimes with variously formed posterior 'pallial sinus.' Pedal gape extending from anterior adductor muscle to fusion of mantle folds to form the short posterior siphons. Foot strong, with byssal gland.

*Remarks.* The family Vesicomysidae was instituted by Dall & Simpson (1901) and later used by Dall (1908). Keen (1969) corrected the spelling to Vesicomysidae but dated it from Dall (1908). Thiele (1934) apparently, and possibly correctly, did not recognize the family Vesicomysidae. He placed *Calyptogena* Dall, 1891 in the Carditidae and *Vesicomys* in Kelliellidae Fischer, 1887 (*nomen correctum* Dall, 1900 *pro* Kelliellidae Fischer, 1887, see Keen, 1969). However, according to Boss (1969b), *Callocardia atlantica* Smith, 1885, the type-species of *Vesicomys* Dall, 1886 may prove to belong in the genus *Kelliella* and, if so, the family name Kelliellidae will take precedence. Alteration of familial and super-familial classification is out of place in the present context, but evidence is accumulating to show that the more primitive heterodont veneroids have been excessively divided at the higher phyletic ranks (Yonge, 1969). Fur-

ther, the difficulty in assigning many taxa currently included in the Vesicomysidae is reflected by their earlier placement in such families as the Arctiidae (= Cyprinidae), Carditidae, Kelliellidae and Veneridae.

The systematics of the family Vesicomysidae is beset with difficulties because there is at present no satisfactory diagnosis which would exclude the constituent taxa from all other heterodonts based on shared derived character states. Among the reasons for this difficulty are the rarity of samples, their considerable variability, the lack of anatomical data, and the ill-defined boundaries of the numerous families of heterodont bivalves with which vesicomysids have been associated.

Most species listed by Lamy (1920), Odhner (1960) and Boss (1969a) are represented by few specimens or by mere fragments. Large ontogenetic series are usually lacking; many species are known from single localities, usually at considerable depths. Vesicomysids, particularly *Calyptogena*, are highly variable (Kanno, 1971). The unreliability of certain conchological features is shown by two obviously conspecific specimens of an undescribed vesicomysid taken in the same dredge haul in the North Atlantic. They are the same size, texture, color, sculpture and shape, but one possesses, and the other lacks, a fully formed, impressed lunule, a feature sometimes used to distinguish genera.

### Genus *Calyptogena* Dall, 1891

*Calyptogena* Dall, 1891: 189 (type-species, by monotypy, *Calyptogena pacifica* Dall, 1891).

?*Pleurophopsis* van Winkle, 1919: 23 (type-species, by monotypy, *Pleurophopsis unioides* van Winkle, 1919).

?*Pleurophopsis* van Winkle. Cossmann, 1920: 29, error for *Pleurophopsis*, van Winkle, 1919.

?*Pleurophoropsis* Cossmann, 1920: 29, *nomen vanum* for *Pleurophopsis* van Winkle, 1919.

*Phreagena* Woodring, 1938: 50 (type-species, by original designation, *Phreagena lasia* Woodring, 1938).

*Ectenagena* Woodring, 1938: 51 (type-species, by original designation, *Calyptogena elongata* Dall, 1916).

*Akebiconcha* Kuroda, 1943: 14 (type-species, by monotypy, *Akebiconcha kawamura* Kuroda, 1943).

?*Hubertschenckia* Takeda, 1953: 85 (type-species, by original designation, *Tapes ezoensis* Yokoyama, 1890).

*Description.* Shell white, usually chalky, heavy, and more or less elongate, length being about 1.5 to 2 or more times the height. Sculpture usually of irregular growth lines, most apparent peripherally. Beaks anterior to middle, generally in anterior third or quarter. Ligament external, opisthodontic, rather strong and resting on variously developed nymphal callosities. Generally without lunule; escutcheon weak or absent to relatively strong. Pallial line broad and generally with shallow posterior indentation or 'pallial sinus.' Valves often constricted mesially, forming gena or cheeks. Periostracum usually dehiscent, dull, variously developed. Dentition irregularly developed, consisting principally of subumbonal cardinal elements without well developed distal lateral dentition. In left valve, subumbonal cardinal tooth more or less curved,  $\supset$ -shaped, with central socket between the two dental elements, which may be referred to as the anterior ramus (or anterior dorsal cardinal tooth) and posterior ventral ramus (or posterior ventral cardinal tooth). Posterior subumbonal cardinal tooth or irregular keel or ridge radiating posteriorly from beneath umbo, just ventral to the beginning of the nymphal callosity, ligament and posterior dorsal margin. Right valve, with subumbonal cardinal teeth, consisting of variously developed  $\supset$ -shaped elements, which may be separated distally into two dental elements (Fig. 10, Cb; Boss, 1968: figs. 16–17) and of a more or less curved ventral tooth, with an irregular  $\supset$ -shaped socket which separates these dental elements. Additionally, posteriorly radiating nymphal callosity subtending the ligament on posterior dorsal margin may appear as subobsolete, ridge-like dental element.

Animal with pedal gape extending from anterior adductor muscle to fusion of mantle folds beneath siphons. Foot strong, variously pointed and with poorly developed byssal gland and groove; apparently non-byssate in adult. Mantle edge thickened, broad anteriorly, and forming an embayment or "pallial sinus" posteriorly in vicinity of short, separate, incurrent and excurrent siphons. Ctenidia homorhabdoid without distinguishable food groove, at least in *C. magnifica*; inner and outer demibranchs present; extensive dorsal extension of ascending lamella of outer demibranch present. Labial palps reduced, obsolete and lip-like. Stomach with style-sac not differentiated from midgut.

*Remarks.* The genus *Calyptogena* and *C. pacifica* Dall were instituted by Dall (1891) in the family Carditidae. He maintained this

placement (1895a: 541; 1903a: 70; 1903b: 1410) and was followed by other authors, notably Lamy (1922: 349), Grant & Gale (1931: 278) and Thiele (1935: 838). *Calyptogena*, however, is not confamilial with the Carditidae because, though the shells are aragonitic, the outer and inner layers in *Calyptogena* are homogeneous while in the Carditidae they are cross-lamellar and have a dense system of tubulations (Oberling & Boss, 1970; Taylor, Kennedy & Hall, 1973). Additionally, carditids usually have strong radial sculpture and crenulate valve margins, are byssate in the adult stage, lack a formed incurrent siphon, have the ventricle beneath the rectum, and have a tendency to brood the young (Boss, 1968; Yonge, 1969). Dall's placement of *Calyptogena pacifica* in the Carditidae may have been based on the superficial resemblance of its hinge with that of *Cardita affinis* Sowerby from the Pacific coast of Mexico (Boss, 1968).

Woodring (1938) indicated the vesicomyid affinities of *Calyptogena* based on hinge structures and established the genera *Ectenagena* (type-species, *C. elongata* Dall, 1916) and *Phreagena* (type-species, *P. lasia* Woodring, 1938). He subsequently indicated that *Phreagena* was a synonym of *Calyptogena* (Winterer & Durham, 1962; Boss, 1968; Woodring, personal communication). The type-species of *Ectenagena* is closely related to *C. pacifica*. Okutani (1966b) suggested that *Calyptogena* and *Akebiconcha* (type-species, *A. kawamurai* Kuroda), a Japanese genus thought to belong to the Cyprinidae (= Arcticidae, see Boss 1969b), were confamilial.

The homology of the hinge elements of the arcticids and vesicomyids is difficult to determine because well-differentiated lateral teeth are not found in *Calyptogena* and there is great infraspecific variation of all dental elements (Fig. 10; Boss, 1968: figs. 16–17 and 19–20). *Akebiconcha* and *Calyptogena* cannot be separated on the basis of valve shape and dentition (Boss, 1968).

There are also many anatomical differences between *Calyptogena* and the single living species of *Arctica* (Saleuddin, 1964; Zatspein & Filatova, 1961). *Arctica islandica* has a laterally compressed, hatchet-shaped foot, the gut is long and elaborately coiled, and the labial palps are distinct and large. In contrast, *Calyptogena* and other known vesicomyids have greatly reduced labial palps, a short gut and a pointed conical foot.

The tenuous inclusion of *Pleurophopsis*

and its synonyms in the synonymy of *Calyptogena* is based on the exceptionally large specimens of an unnamed species of *Pleurophopsis* from supposed Oligocene deposits in Colombia (USNM 11253, "No. 33, from a point ¼ mile north of junction of Arroyo-Piedras Palmar and Palmar-Molinero road on the Palmar-Molinero road. Plane table station 245 of Link and White"). The coordinates of sta. 245 are 10°40'N; 75°03'W, a point several miles south of Barranquilla, Colombia. These specimens exceed 200 mm in length and, externally, appear very close to *Calyptogena* but the hinge structure is unknown. Species associated with *Pleurophopsis* in Oligocene deposits of Peru include *Solemya* and *Vesicomya*, further evidence of a relationship between *Calyptogena* and *Pleurophopsis* (Olsson, 1931). The type-species of *Pleurophopsis* from Trinidad, originally thought to be Oligocene but probably Pliocene (Woodring, personal communication), is similar to *Calyptogena* in outline and has two cardinal teeth in each valve (Woodring, 1938).

*Hubertschenckia* Takeda, based on an Oligocene fossil, is tentatively considered a synonym of *Calyptogena* because Keen (1969) and Habe (1977) included it in the Vesicomidae and Kanno (1971) infers that it is closely related to *Calyptogena*.

Although Habe (1977) placed the genus *Adulomya* Kuroda, 1931 in the Vesicomidae and though some species that were once referred to it (e.g. *Adulomya chitanii* Kanehara, 1937) are species of *Calyptogena* (see Kanno, 1971: 80–82, text-figs. 10–12, and pl. 7, figs. 5, 6a–b, and pl. 17, fig. 12), we have not considered it a synonym of *Calyptogena* because the type-species of *Adulomya*, *A. uchimuraensis* Kuroda, is supposedly edentulous and is not a vesicomid (Kanno & Ogawa, 1964: 285). According to Cox (1969), *Adulomya* belongs in the Solemyidae.

Most species of *Calyptogena*, both living and fossil are found in the Pacific Ocean, occurring from Japan to the Gulf of Alaska and south to off South America. In the Atlantic they are known from the Caribbean and off the coast of Africa. They occur from the Oligocene to the Recent and in depths ranging from about 100 m to over 2600 m. (Ap-

pendix 2 lists the species currently referable to the genus *Calyptogena*.)

#### Subgenus *Ectenagena* Woodring, 1938

*Ectenagena* Woodring, 1938: 51 (type-species, by original designation, *Calyptogena elongata* Dall, 1916).

*Description.* Shell similar to *Calyptogena*, s.s., sometimes exceeding 200 mm in length. Escutcheon generally not demarcated nor well developed. Dental configuration as in *Calyptogena* except teeth more or less blunt and comparatively shorter; hinge plate comparatively less extensive and thinner. Right valve lacking anterior dorsal cardinal element, probably resulting from reduction of dorsal ramus of ∩-shaped subumbonal cardinal tooth (Fig. 10, Eb and Fb). Ctenidia with strong interlamellar septa.

*Remarks.* Boss (1968) used *Ectenagena* as a genus but, considering the intraspecific variation of *Calyptogena*, s.s. and the paucity of distinguishing traits, we follow Keen (1969) in considering it a subgenus of *Calyptogena*.

As we are placing the white clam from the Galapagos Rift in the subgenus *Ectenagena* we include here a description of *C. elongata*, the type-species of the subgenus.

#### *Calyptogena (Ectenagena) elongata* Dall, 1916

Figs. 10E, 11, 12A–C

*Calyptogena elongata* Dall, 1916: 408 (Albatross Sta. 4432, off Point Loma, California, in 275 fathoms [8 mi. S. of Brockway Point, Santa Rosa Id., Channel Ids.];<sup>2</sup> holotype, USNM 110774); 1921: 32, pl. 3, fig. 3; Oldroyd, 1924: 116, pl. 22, fig. 6; Grant & Gale, 1931: 279; Oinomikado & Kanehara, 1938: 73; Otatume, 1942: 198; Okutani, 1957: 28; Okutani, 1962: 23; Bernard, 1974: 18, *non C. elongata* Ozaki, 1958.

*Ectenagena elongata* (Dall). Woodring, 1938: 51, fig. 2c; Boss, 1968: 739, 744, figs. 25, 28; Bernard, 1974: 19.

*Calyptogena (Ectenagena) elongata* (Dall). Keen, 1969: N664, fig. E138, 8a, b.

*Range.* Known only from the type-locality—Albatross Sta. 4432, 8 miles S. of Brockway

<sup>2</sup>The three specimens are catalogued separately. In the original description Dall gave the locality for the holotype (USNM 110774) as Albatross Station 4432, off Point Loma, California in 275 fathoms and the specimen is so labeled in the USNM. A paratype (USNM 205888) is labeled as from the same station but the depth is given as 183 fathoms. The third specimen, a paratype (USNM 209309), also from Albatross Station 4432 is labeled as off Santa Rosa, Santa Barbara Island, California in 270–280 fathoms. Recourse to the Dredging and Hydrographic Records for 1904 and 1905 (published 1906) give the station data as indicated under *Range*.

Point, Santa Rosa Island, Channel Islands in 272–270 fathoms [500 m].

*Specimens examined.* Holotype and two paratypes (only known specimens).

*Description.* Shell white, elongate, elliptical, equivalved but inequilateral, periostracum yellow-brown, largest known specimen 44 mm in length, 17.5 mm in height and 10 mm in width. Umbos low, small, pointed and located on anterior ¼ of valves. Anterior margin of valves rounded, anterior dorsal margin ¼ total dorsal margin and sloping from the umbos at an angle of about 20°. Ventral margin long, nearly straight. Posterior margin rounded, posterior dorsal margin ¾ total dorsal margin sloping from umbos at an angle of about 10°. Valves smooth, sculptured only with rather conspicuous incremental growth lines. Escutcheon and lunule absent. Ligament moderate in size (based on area of attachment, the ligament proper was missing in the type specimens) extending about ½ posterior dorsal margin. Periostracum thin and uniform over entire valve.

Interior of valve porcelaneous white, muscle scars and pallial line impressed. Anterior adductor scar rounded anteriorly, nearly straight posteriorly, well impressed. Anterior pedal retractor triangular in outline, impressed and located near the dorsal, posterior margin of the anterior adductor muscle. Posterior adductor sub-elliptical, lightly impressed, co-extensive with the posterior pedal retractor anteriorly. Pallial muscle scar only lightly impressed.

*Measurements* (mm).

length	height	width	
44	17.5	10.0	USNM 110774: holotype
38.8	16.2	09.3	USNM 205888: paratype
38.7	16.2		USNM 209309: paratype

*Remarks.* *Calyptogena elongata* is known only from the shells of the three small specimens which constitute the type-series and which may be the young of a much larger species. Though most species in the Vesicomidae are small, those in the genus *Calyptogena* such as *C. pacifica* Dall, *C. modioliforma* (Boss) and *C. ponderosa* Boss are larger. Specimens of these species may reach 100 mm or more in length.

Dall (1916) related *C. elongata* to *C. pacifica*, and Boss (1968) stated that *C. modioliforma* was most closely related to, and was

the Atlantic homolog of *C. elongata* from which it differed in being larger and higher. *Calyptogena elongata* is probably most closely related to *C. magnifica*, differing in having a more uniform persistent periostracum, more anteriorly placed umbos, a smaller ligament, in lacking the "shelf" beneath the ligament so prominent in *C. magnifica* and in having a similar but more delicate hinge area. See also *Remarks* under *C. magnifica*. Unfortunately, until the soft anatomy of *C. elongata*, and for that matter other species of *Calyptogena*, is known, it is impossible to state definitely the relationship of these species.

*Calyptogena (Ectenagena) magnifica*,  
Boss & Turner, species novum  
Figs. 1–9, 10F–G, 11, 12D–F, 13

*Types.* Holotype, Mollusk Department, Museum of Comparative Zoology, Harvard University, no. 288500, from Galapagos Rift vent ALVIN Dive 717. Paratypes have been deposited in the Museum of Comparative Zoology (MCZ), the Division of Mollusks, National Museum of Natural History (United States National Museum, USNM), the Department of Malacology of the Academy of Natural Sciences of Philadelphia (ANSP), The Department of Invertebrate Zoology, Los Angeles County Museum (LACM), Mollusca Section of the British Museum (Natural History) (BMNH), Muséum National d'Histoire Naturelle, Paris (MNHN) and the Invertebrate Collection of the Scripps Institution of Oceanography (SIO) and are all from ALVIN dives as follows: 727 (MCZ: USNM); 879 (MCZ); 887 (MCZ); 888 (MCZ); 892 (MCZ); 895 (MCZ); 896 (MCZ); 981 (SIO); 983 (MCZ); 984 (MCZ; ANSP; BMNH; LACM; MNHN; SIO; USNM); 986 (MCZ); 991 (MCZ).

*Type-locality.* The holotype is from ALVIN Dive 717 at 0°47.9'N; 86°08.5'W in 2495 m. Paratypes are from other vents on the Galapagos Rift taken on ALVIN dives listed under *Specimens examined* and from ALVIN Dive 981 on the East Pacific Rise vent at 20°50'N; 109°06'W in 2600 m off Mexico.

*Range.* This species is apparently confined to the area of the thermal vents along the Galapagos Rift and the East Pacific Rise from 21°N south to 0°47'N in depths ranging from 2445 to 2680 m.

*Species examined.*<sup>3</sup> Mexico: ALVIN

<sup>3</sup>Specimens identified from pictures only show that *C. magnifica* was also seen on ALVIN Dive 909, 20°51.9'N; 109°4.4'W in 2645 m; ALVIN Dive 915, 20°51'N; 109°04.9'W in 2655 m; ALVIN Dive 917, 20°49.9'N; 109°04.8'W in 2655 m (all about 200 miles off Punta Mita, Mexico) as well as ALVIN Dive 733 (see Fig. 1A) from 0°47.3'N; 86°07.8'W in 2496 m.

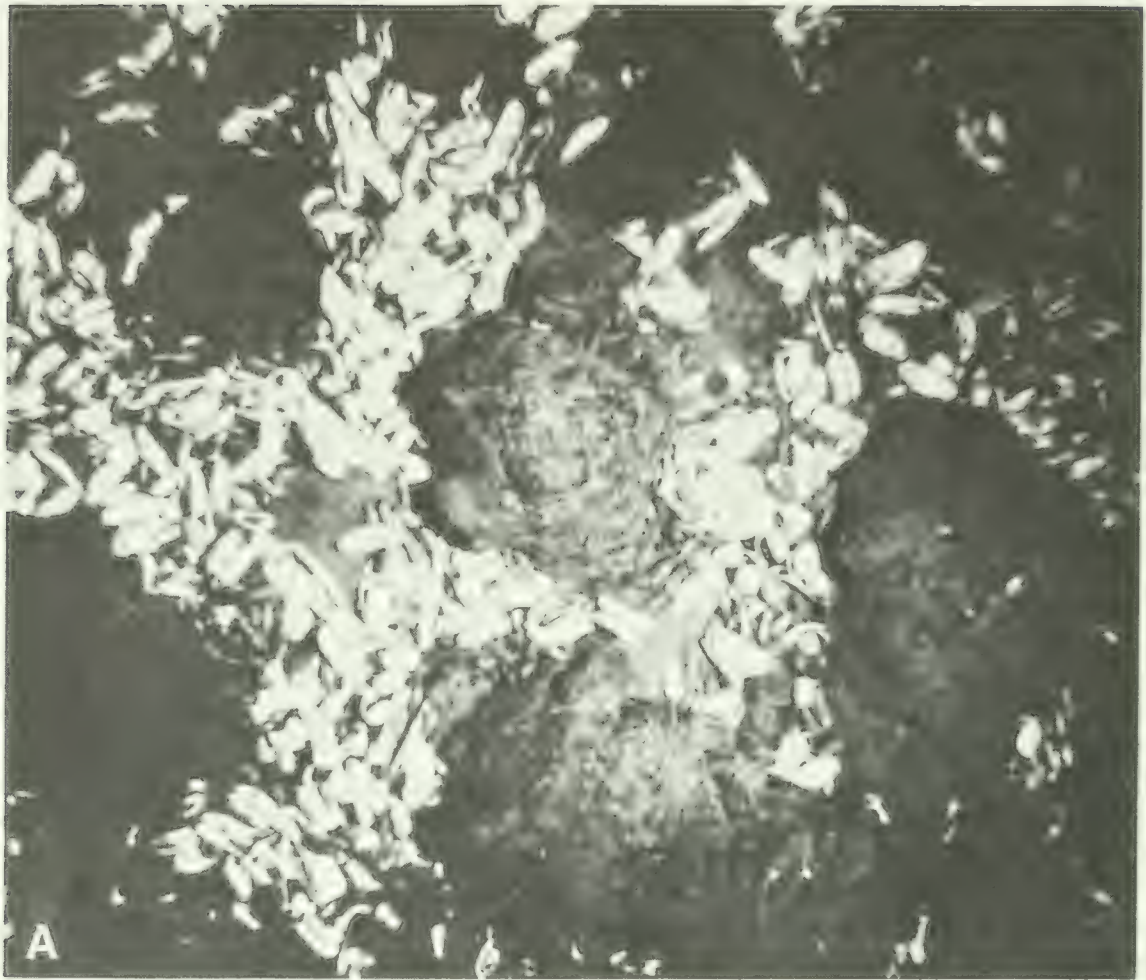



Dive 981, 20°50'N; 109°06'W in 2600 m (about 20 miles W of Punta Mita, Mexico) (1 entire specimen); Galapagos Islands (all on the Galapagos Rift, about 200 miles NE of San Cristobal Island): ALVIN Dive 727, 0°47.4'N; 86°08.9'W, in 2680 m (2 specimens); ALVIN Dive 879, 0°48.18'N; 86°04.11'W, in 2495 m (1 specimen); ALVIN Dive 887, 0°48.5'N; 86°09.1'W in 2488 m (2 specimens); ALVIN Dive 888, 0°47.07'N; 86°08.5'W, in 2478 m (1 specimen); ALVIN Dive 892, 0°48.3'N; 86°13.8'W, in 2454 m (4 specimens); ALVIN Dive 895, 0°47.9'N; 86°09.3'W, in 2480 m (1 specimen); ALVIN Dive 896, 0°48.23'N; 86°13.6'W, in 2445 m (1 specimen); ALVIN Dive 983, 0°48.24'N; 86°13.47'W in 2450 m (2 specimens); ALVIN Dive 984, 0°48.24'N; 86°13.47'W in 2450 m (30 specimens); ALVIN Dive 986, 0°47.89'N; 86°9.21'W in 2492 m (2 specimens); ALVIN Dive 991, 0°47.89'N; 86°9.21'W in 2492 m (3 specimens).

*Description.* Shell white, thick, brittle, chalky in texture, slightly gaping, equivalve, elongate, and subelliptical; present specimens reaching 240 mm<sup>4</sup> in length, 110 mm in height and 60 mm in width (Figs. 2–4). Valves inequilateral; umbos low, abraded in adult, and located on anterior third of valve. Anterior margin of valves rounded, ventral margin long, variable, ranging from nearly straight to rather strongly concave medially; posterior margin broadly rounded, posterior dorsal margin about 2/3 total dorsal margin, descending from umbo at angle of about 12°; anterior dorsal margin about 1/3 length and descending at angle of about 26° from umbo (Fig. 11). Valves nearly smooth, sculptured with irregular growth ridges interspersed with fine irregular growth increments (Fig. 3A). Escutcheon and lunule not developed. Ligament massive, extending length of posterior dorsal margin, opisthodontic and parivincular with strong periostracal layer, thick calcareous outer layer and thin inner layer. Periostracum dark brown, coextensive with ligament dorsally,

forming thick “ruffled” band along anterior margin in many specimens, extending posteriorly to about midway along the ventral margin, but reduced to traces on posterior margin and along growth ridges (Fig. 4C–E).

Interior of valves porcelaneous white, muscle scars and pallial line impressed. Anterior adductor scar rounded anteriorly, irregular posteriorly and deeply impressed. Anterior pedal retractor deeply impressed, elongate, irregular in outline and located slightly dorsal and posterior to anterior adductor scar (Fig. 3B, C). Posterior adductor scar irregularly subelliptical, rounded posteriorly and coextensive with small rounded posterior pedal retractor anteriorly. Ventral pallial muscle scar broad anteriorly, becoming narrower over midportion of valve (disc) and broadening again posteriorly where its breadth and slight indentation suggest a “pallial sinus.” Fine, closely spaced scars extending dorsally at right angle from ventral pallial line indicating variable mantle attachments (Fig. 3B). Series of small scars just ventral to hinge line marking dorsal mantle attachments. Distinct, but difficult to discern, scars in umbonal cavity on inner medial surface of cardinal plate marking insertion of ctenidial retractor or elevator muscle (Figs. 5 [no. 11], 8C).

*Ligament.* (Figs. 2A, 3B, C, 4A, B, 12D–F). Large strong, external opisthodontic; extending from umbo posteriorly to posterior pedal retractor muscles, subtended by elongate nymphal callosities and underlain by highly differentiated fused mantle isthmus. Periostracal layer elastic, horny, differentiated into thin, blackish outer portion and horn-colored inner portion, and becoming yellowish posteriorly. Outer layer thick, calcareous (somewhat disintegrated anteriorly in specimen dissected) with closely-spaced dorso-ventral cleavage planes. Inner layer thin, immediately ventral to outer calcareous layer and formed by mantle isthmus. For a discussion of the structure of the bivalve ligament see Yonge (1978a).

<sup>4</sup>A specimen we have not seen was reported by Keen (1977b) to be 250 mm in length; another collected in 1979 by Mr. G. Ellis, an ALVIN Pilot, was 263.5 mm long.



FIG. 1. A) Expired hot vent at the site referred to by Corliss & Ballard (1977) as Clambake II (0°47.3'N; 86°07.8'W; 2496 m). ALVIN Dive 733, with large numbers of dead *Calyptogena magnifica* Boss & Turner. B) Habitat shot of an active hot vent (referred to as Clambake I) showing a few living *Calyptogena magnifica* nestled among large numbers of mussels and with a few large galatheid crabs running around and over them (0°47.4'N; 86°08.9'W; 2680 m), ALVIN Dive 727. (Photographs courtesy R. Ballard, Woods Hole Oceanographic Institution.)

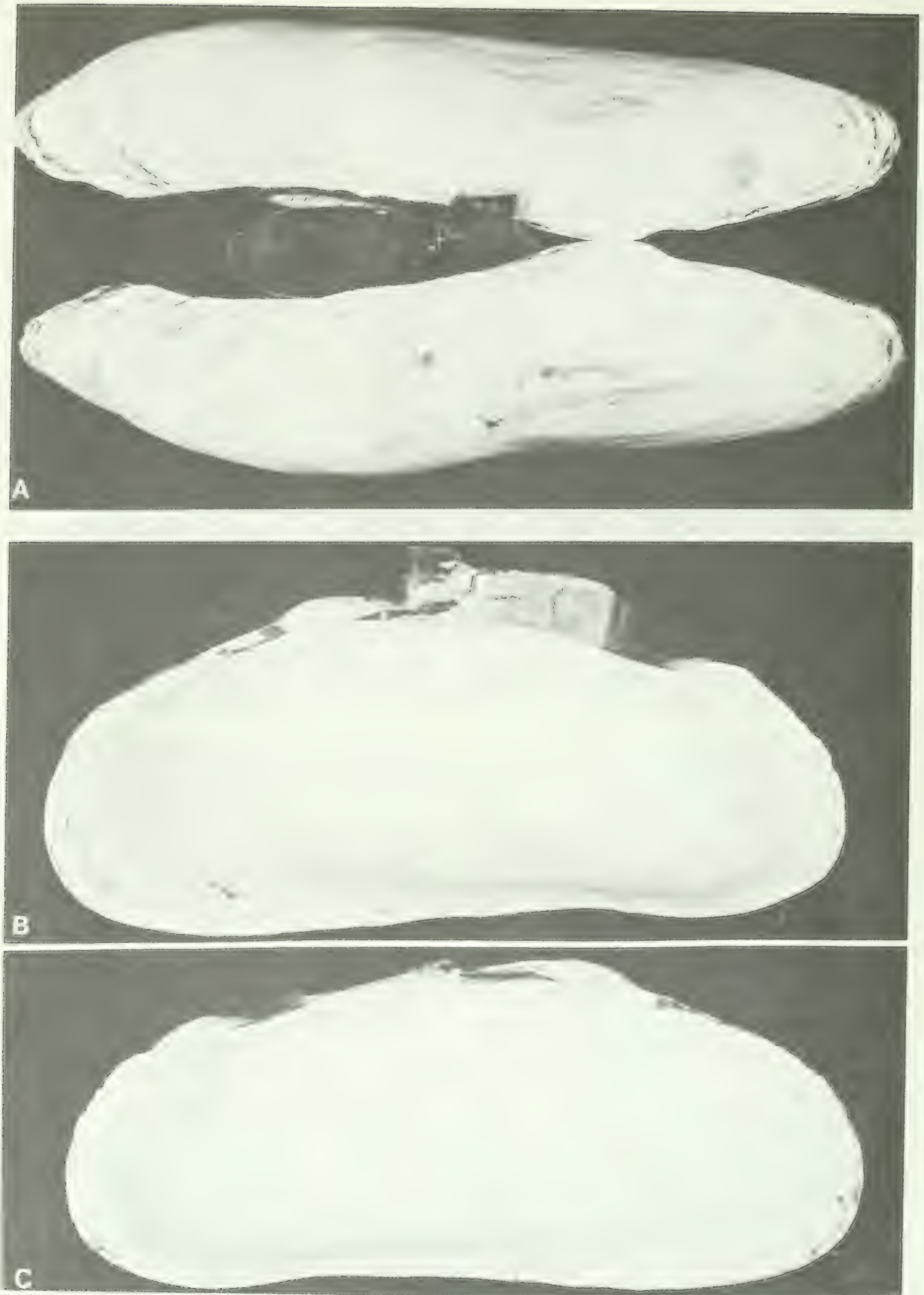

FIG. 2. *Calyptogena magnifica* Boss & Turner. A) Dorsal view of apposed valves. B) Inner view of right valve. C) Inner view of left valve. (Scale is in mm.) Specimens from Clambake I, 0°47.4'N; 86°08.9'W at 2680 m, taken on ALVIN Dive 727. Specimens at Woods Hole Oceanographic Institution. (All pictures by Woods Hole Oceanographic Institution Photographic Laboratory.)

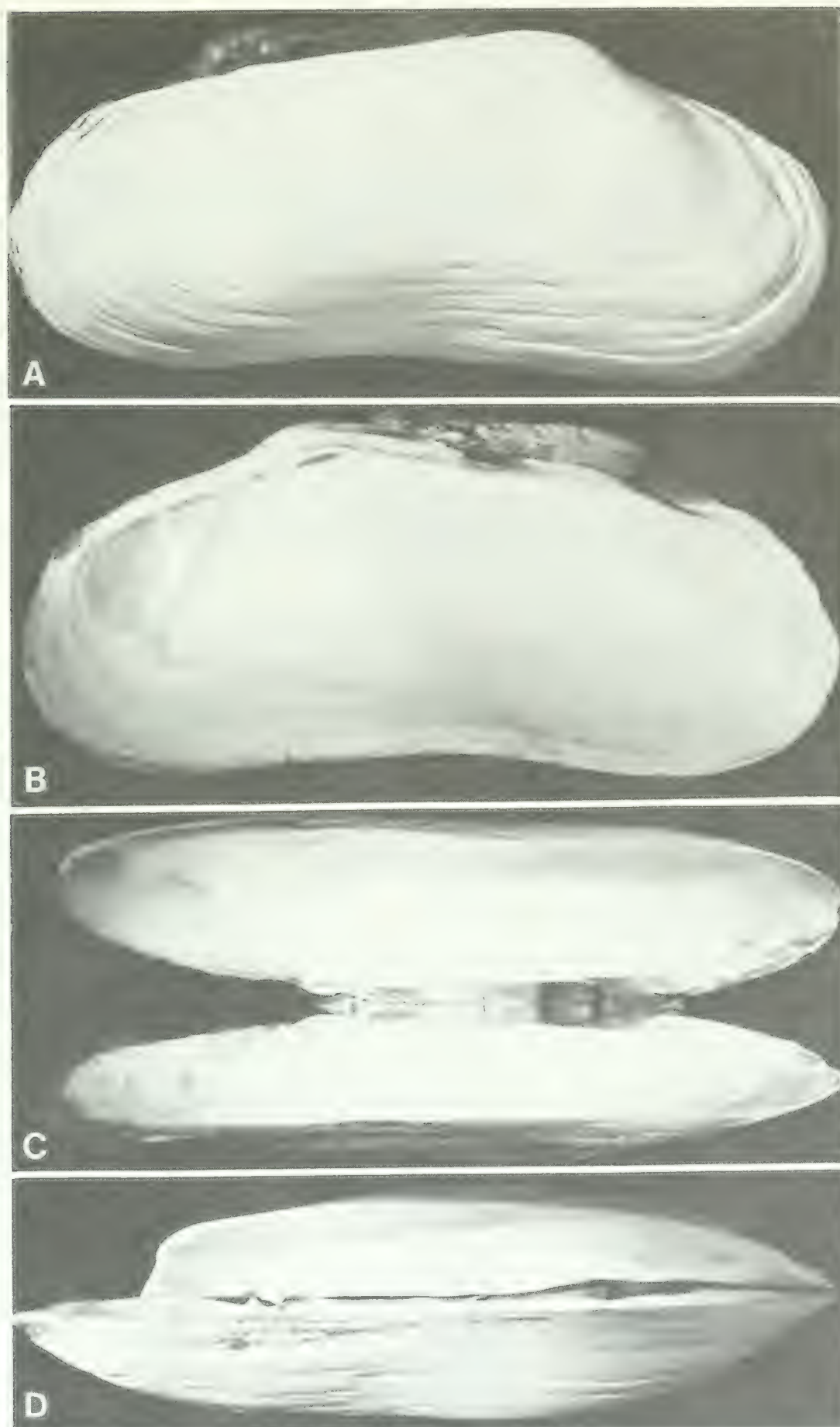
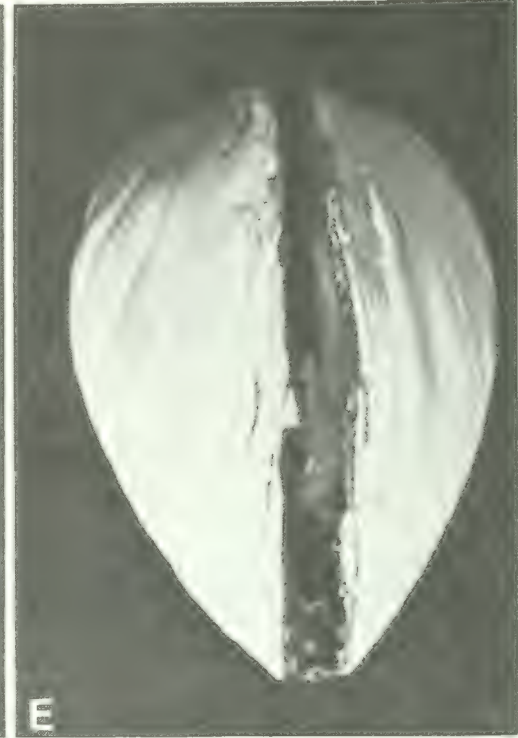
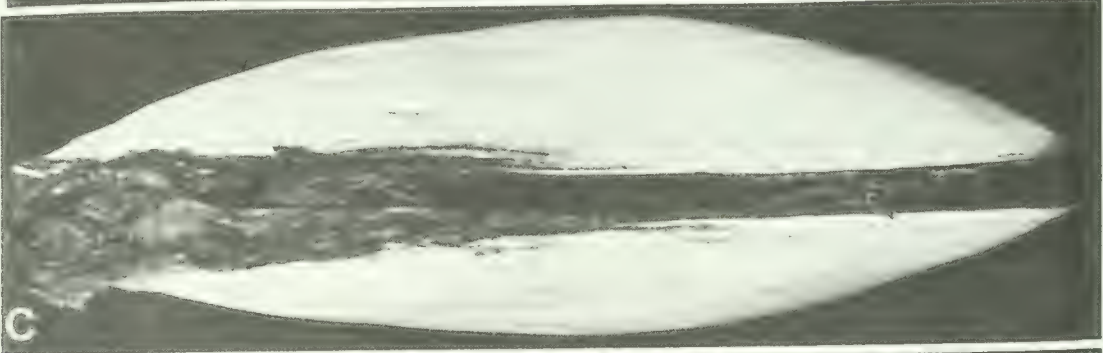
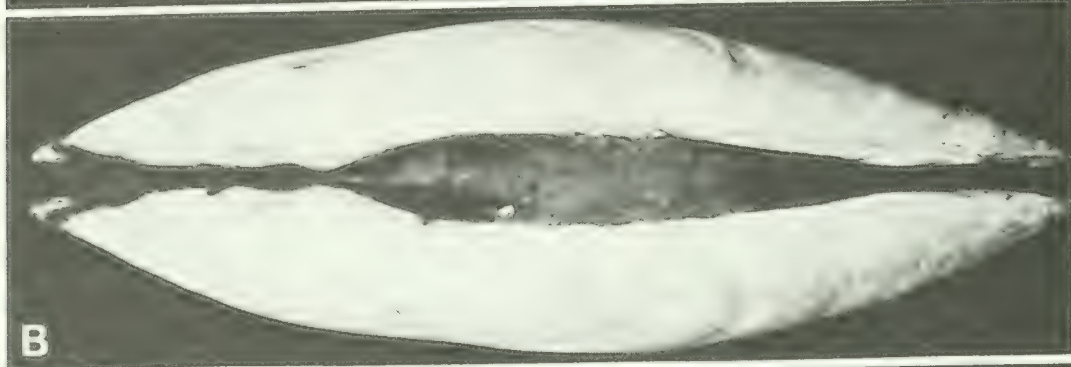

FIG. 3. *Calyptogena magnifica* Boss & Turner. A) Outer view of right valve. B) Inner view of right valve showing external ligament, muscle scars, hinge. C) Inner view of apposed valves to show ligament and hinge when valves are gaping. D) Inner view of apposed valves with the left valve broken showing position of hinge and ligament when valves are closed, and anterior pedal retractor muscle scars. Specimen in A, B and D is 240 mm in length (paratype MCZ 288499) from ALVIN Dive 727. Specimen in C is 190 mm in length (holotype MCZ 288500) from ALVIN Dive 717. (Photographs by A. Coleman, Photographic Laboratory, Museum of Comparative Zoology.)



*Hinge teeth* (Figs. 10F–G, 12E–F). Dentition irregular and somewhat worn in larger specimens. Hinge plate concomitantly thickened but rather small for large shelled individuals. Left valve with  $\supset$ -shaped subumbonal cardinal tooth consisting of weak, more or less straight, ridge-like, upcurled dorsal anterior ramus or tooth radiating from umbo, ventral ramus or tooth with two blunt points; excavated  $\supset$ -shaped socket between; weak ridge-like keel or posterodorsal cardinal tooth radiating posteriorly from umbo toward nymphal callosity. Right valve with diverging subumbonal cardinal dentition and lacking an anterior dorsal cardinal element which probably represents a reduction of the  $\supset$ -shaped umbonal cardinal tooth in *Calyptogena*, s.s. Posterior cardinal tooth blunt to shelf-like and ventral cardinal element more or less sharply keeled, upcurled, and ridge-like; elements separated by  $\supset$ -shaped socket. Somewhat excavated between teeth and anterior dorsal margin.

*Measurements* (mm).

length	height at umbo	width	ALVIN Dive	
240	110	60	727	Paratype
208.7	87.1		887	Paratype
196.5	86.1		888	Paratype
196.1	88.5		887	Paratype
190	79.4		717	Holotype
188.5	88.4		895	Paratype
180.0	78.2	53.3	879	Paratype
179.5	76.8	45.9	727	Paratype
130.6	57.2	36.8	896	Paratype
82.5	36.5	22.0	892	Paratype
56.7	25.5		984	Paratype
54.8	24.8		984	Paratype
54.2	23.7		984	Paratype
34.5	16.8		984	Paratype

*Animal*. Description of morphology of soft parts based on two preserved specimens available for study; the details of internal anatomy based on single specimen (for notes on living specimens see Appendix 1).

*Mantle and siphons*. Mantle lobes bilaterally symmetrical, with unusual thickenings both anteriorly and posteriorly (Fig. 5, nos. 2, 36,

54 & 55) firmly attached to shell ventrally by broad pallial muscles and dorsally by series of small muscles just ventral to mantle isthmus. Mantle cavity open ventrally from anterior adductor muscle posteriorly to base of incurrent siphon. Mantle with outer fold producing calcareous shell layers; periostracal glands on inner surface of outer fold giving rise to extensive, thick periostracum, particularly at anterior end (Fig. 4C, D), and middle fold with short papillae (Fig. 5, no. 3; Fig. 6A).

Inner mantle folds fused anteriorly over anterior adductor muscle to mantle isthmus; posterior fusions of inner lobe forming incurrent and excurrent siphons (Figs. 6E, 7C) and extending over dorsal surface of posterior adductor muscle to mantle isthmus.

Pallial muscles particularly extensive ventral to anterior adductor muscle and in region of siphons (Fig. 5, nos. 36, 55). Anterior thickened region of mantle heavily vascularized and glandular.

Siphons separate (Fig. 5, nos. 32, 34; Figs. 6E, 7C); incurrent siphon narrow, elliptical, and with numerous (about 40) short papillae on its inner margin; excurrent siphon rounded and lacking papillae. Rather large, rounded "papilla" ventral to incurrent siphon.

*Muscles and foot*. Anterior and posterior adductor muscles (Fig. 5, nos. 4 & 29) sheathed with heavy connective tissue, and composed of antero-ventral "catch" portion and larger mostly postero-dorsal "quick" portion; fibers form discrete bundles (Fig. 6C, D).

Anterior pedal retractor muscles (Fig. 5, no. 6) arising in postero-dorsal portion of foot and extending anteriorly through visceral mass to insert on valves beneath hinge plate just posterior and dorsal to anterior adductor muscle. Posterior pedal retractor muscles (Fig. 5, no. 26) arising in antero-dorsal portion of foot and inserting on valves adjacent to dorsal anterior portion of posterior adductor muscle.

Foot large and composed of two distinct portions, graded dorsally into wall of visceral mass and composed of several discrete layers of longitudinal and oblique muscles.

FIG. 4. *Calyptogena magnifica* Boss & Turner. Holotype MCZ 288500 from ALVIN Dive 717 (see also Fig. 3C). A) Dorsal view of gaping valves, after removal of body. B) Dorsal view of closed valves to show ligament and dorsal extension of the periostracum. C) Ventral view of apposed valves to show width of the specimen and the development of the periostracum along the ventral margin. D) Anterior view of apposed valves to show slight anterior gape and the development of the ruffled periostracal layers along the anterior margin. E) Posterior view of apposed valves to show width of specimen and lack of periostracum. (Photograph A by A. Coleman, Photographic Laboratory, Museum of Comparative Zoology; B–E, by R. D. Turner.)

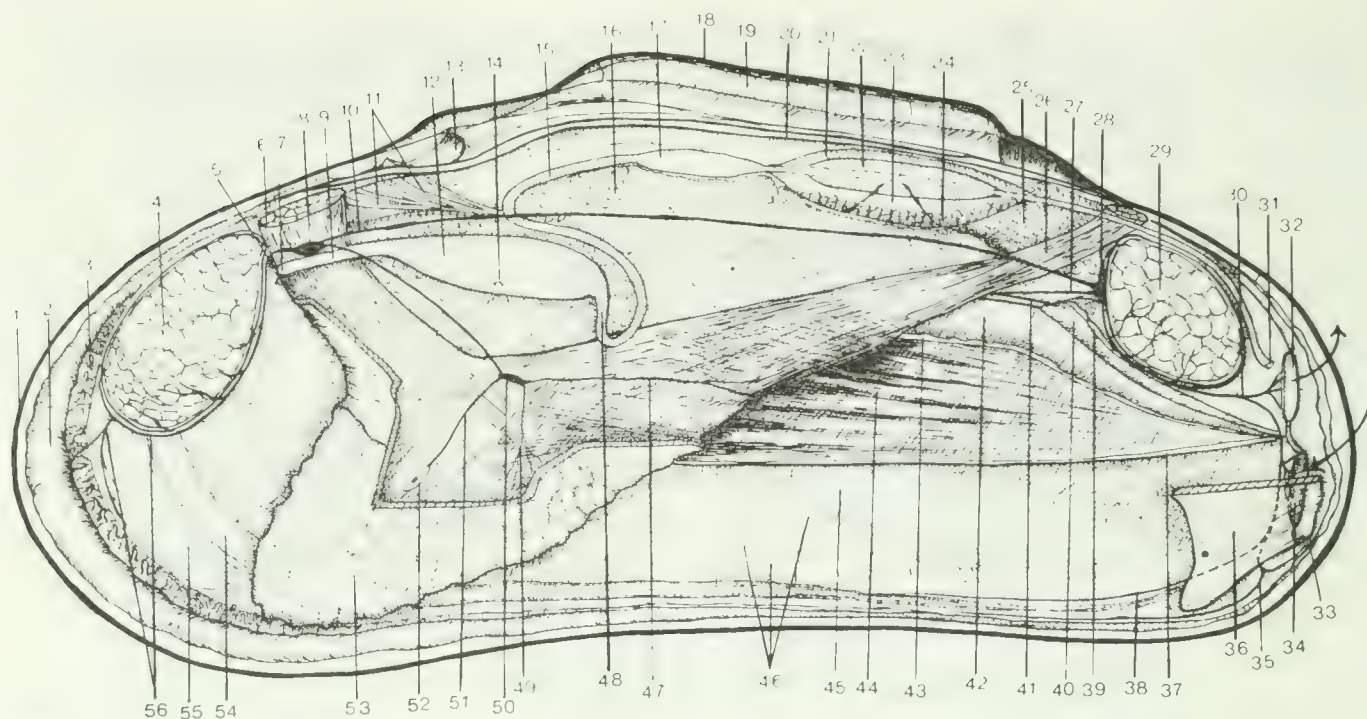

FIG. 5. Semidiagrammatic sketch of the anatomy of *Calyptogena magna* Boss & Turner. The valve, mantle, ctenidium and outer layers of body wall on the left side have been removed and a section of the foot cut away. 1. shell; 2. thickened outer edge of mantle; 3. band of sensory papillae; 4. anterior adductor muscle; 5. labial palp (upper); 6. anterior pedal retractor; 7. mouth; 8. cerebral ganglion; 9. esophagus; 10. cerebro-visceral connective; 11. ctenidial retractor or elevator muscle; 12. stomach; 13. hinge tooth; 14. opening of duct of digestive gland into stomach; 15. intestine; 16. digestive gland; 17. broadened section of intestine with typhlosole; 18. periostracal layer of ligament; 19. outer layer of ligament; 20. mantle; 21. pericardium; 22. ventricle; 23. auricle; 24. pericardial gland; 25. kidney; 26. posterior pedal retractor muscle; 27. branchial nerve; 28. visceral ganglion; 29. posterior adductor; 30. pallial nerve; 31. anus; 32. excurrent siphon; 33. fusion of inner mantle lobe to form incurrent siphon; 34. incurrent siphon lobes; 35. outer circumpallial nerve; 36. section of muscular portion of posterior mantle which forms the "pallial sinus"; 37. smooth margin of ctenidium; 38. inner circumpallial nerve; 39. torn edge of ctenidial attachment; 40. descending lamella of outer demibranch of right ctenidium; 41. ctenidial vein; 42. descending lamella of inner demibranch of right ctenidium; 43. torn edge of ctenidial attachment; 44. ascending lamella of inner demibranch of right ctenidium; 45. thickened spongy glandular area of mantle; 46. "ducts" in mantle; 47. posterior pedal nerve; 48. mid-gut; 49. ventral pedal nerve; 50. pedal ganglion; 51. statocyst nerve; 52. statocyst; 53. papillose foot; 54. circumpallial "vessel"; 55. thickened anterior mantle; 56. anterior pallial nerve.

Ventral portion of foot pointing anteriorly and sub-conical in shape (triangular in side view), strongly rugose and papillate in preserved specimens. Histologically, outer layer highly glandular and inner portion forming complex of crossing muscle fibers. Byssal groove discernible along mid-ventral line of rugose por-

tion of foot; small, byssal gland located at junction with heel; specimens lacking byssus.

**Ctenidia.** Large, thick, homorhabdic, non-plicate, covering entire visceral mass from pericardial cavity to ventral portion of foot, and composed of large inner, and small outer demibranchs, both with descending and

FIG. 6. *Calyptogena magna* Boss & Turner (compare these halftones with the drawings in Figs. 5 and 7). A) Opened specimen still partially attached to the valves showing the thickened mantle margin, the papillae, periostracal groove and periostracum. B) Specimen removed from shell, with the left mantle lobe turned back, and with left ctenidium still in place. C) Ventral view showing relation of ctenidia to posterior adductor muscle: a, outer demibranch and b, inner demibranch of left ctenidium; c) inner demibranch and d, outer demibranch of right ctenidium; e, posterior adductor muscle showing discrete muscle bundles; f, opening to excurrent siphon. D) Ventral view of anterior end showing: a) anterior adductor muscle; b, mouth; c, dorsal lip; d, ventral lip; e, outer demibranch of left ctenidium; f) inner demibranch of left ctenidium; g, foot. E) Posterior view showing: a, excurrent siphon; b, incurrent siphon; c, sensory knob; d, fused inner mantle lobe; e, outer mantle lobe; f, posterior adductor muscle; g, muscular portion of posterior mantle. (Photographs by R. D. Turner.)

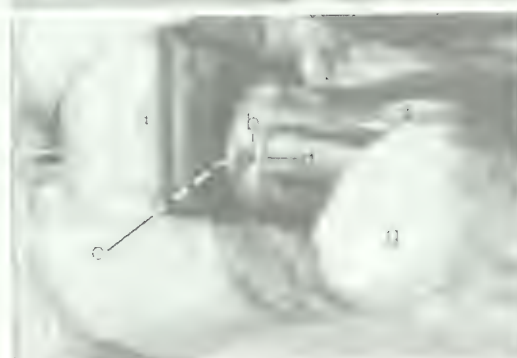

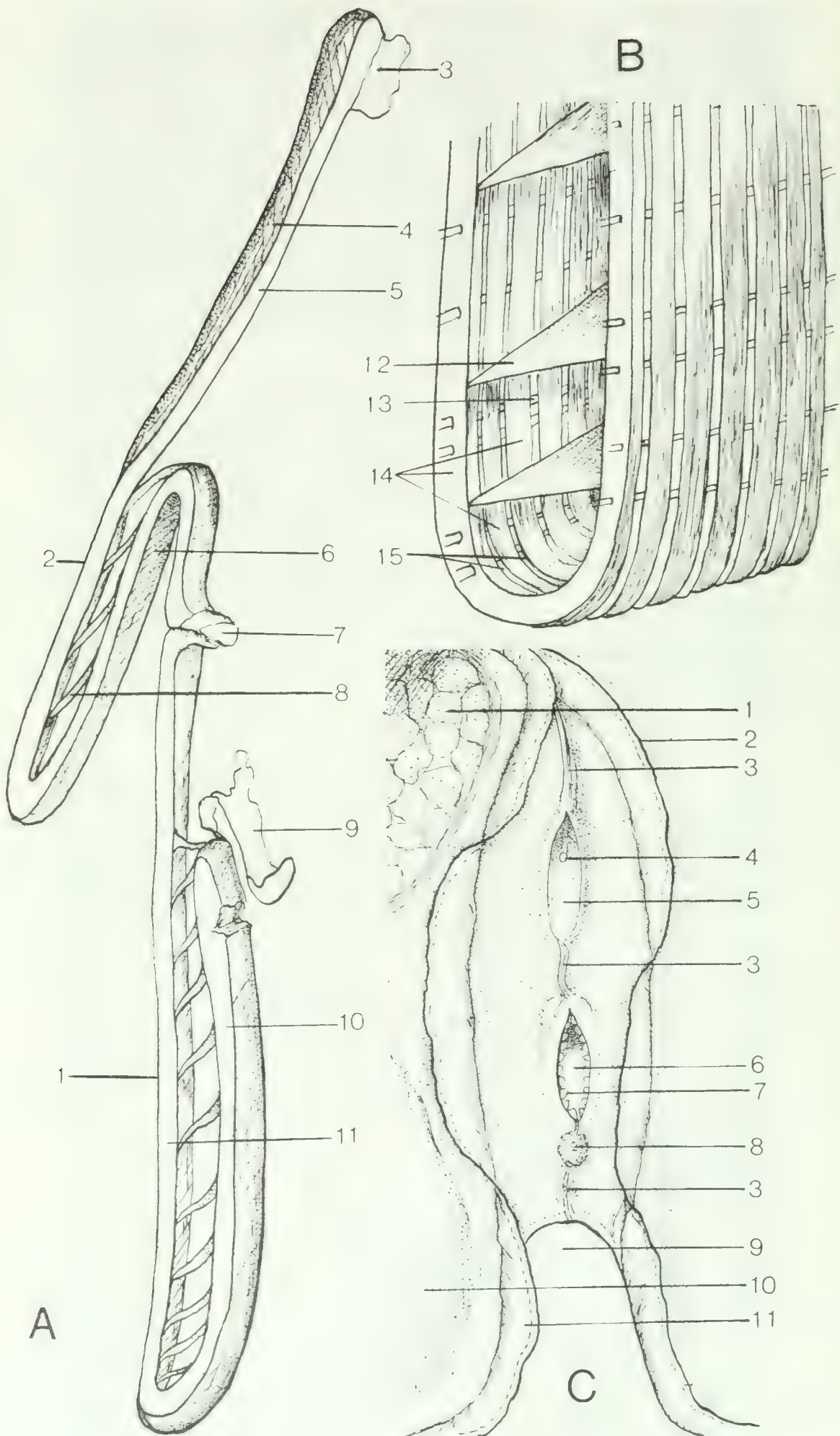



ascending lamellae (Figs. 7a, B, 8A, B). In preserved specimens, gills contracted dorso-ventrally, producing antero-posterior ridges and a "herring-bone" appearance to filaments and their chitinous rods (Fig. 8A). Paired demibranchs weakly fused to each other posteriorly and weakly attached to the siphonal septum distally, thus separating small epibranchial or anal chamber from large infrabranchial chamber. Ascending lamellae of outer demibranchs fused to visceral mass anteriorly and to mantle posteriorly; strong interlamellar septa uniting lamellae; filaments fused by numerous interfilamentar junctions (Figs. 7A, B, 8B). Ventral margin of both demibranchs appearing smooth and showing no evidence of food groove (Fig. 8A) in preserved specimens.

*Digestive system.* Mouth small, rounded, located just posterior to the anterior adductor muscle. Labial palps greatly reduced, and consisting of small non-plicate ridges (Fig. 6D), representing vestiges of inner palpal lamellae. Dorsal (= anterior) palpal ridge, co-extensive with the ctenidium, fusing with distal edge of ascending lamella of outer demibranch; ventral (= posterior) palpal ridge fusing with inner demibranch.

Mouth opening into short, thin-walled esophagus (Fig. 5, no. 9) leading to thin-walled elongate stomach about four times diameter of esophagus (Fig. 5, no. 12). Large, paired digestive diverticula with numerous secondary dichotomising ducts opening into latero-ventral anterior third of stomach via large short ducts. Short combined midgut-style sac (though no style detected) extending from stomach postero-ventrally to thin-walled intestine which recurves sharply dorso-anteriorly paralleling midgut to about midway over stomach where it turns postero-dorsally as flattened ribbon-like structure and passes through visceral mass to pericardial cavity; posterior half of this section of intestine with thickened walls and ventral typhlosole (Fig. 5,

no. 17). Rectum thin-walled in pericardial cavity, surrounded by extensive anterior aorta and muscular ventricle, passing through kidneys and between posterior pedal retractor muscles. Rectum ribbon-like posteriorly, imbedded in sheath of posterior adductor muscle and extending over dorsal surface of posterior adductor muscle to terminate at papillate anus in epibranchial chamber near the opening of excurrent siphon.

Stomach of specimen examined empty, except for clear whitish mucous-like material; rectum also empty and flattened throughout its length.

*Circulatory and excretory systems.* Pericardium large, elongate and located postero-dorsally on surface of visceral mass and posteriorly between kidney and pedal retractor muscles. Pericardial walls somewhat thickened but transparent and elaborated ventrally into extensive pericardial glands of two distinct types (Fig. 5, no. 24). Ventricle thick-walled, muscular, surrounding rectum and broadly furrowed dorsally. Anterior aorta also thick walled, extending anteriorly from ventricle and surrounding intestine as it enters pericardium. Auricles large, paired, thin-walled, triangular, opening into ventricle mid-laterally via small ostia and collecting blood from elongate ctenidial sinuses. Remaining portions of circulatory system not discerned but appearing to consist of many open sinuses.

Kidneys occupying space between pericardium and posterior adductor muscle and enveloping posterior pedal retractor muscles. Paired reno-pericardial apertures opening at postero-ventral extremity of pericardium and leading into ventral proximal portion of kidney. Dorsal distal portion of kidney sac-like and apparently interconnected medially. External opening of kidney into suprabranchial cavity not observed.

*Nervous system.* Ganglia and nerves easily discerned (Figs. 5, 9). Cerebral ganglia (Fig. 5, no. 8) situated beneath anteroventral sur-

FIG. 7. *Calyptogena magnifica* Boss & Turner. A) Diagrammatic sketch of section through ctenidium. 1. inner demibranch; 2. outer demibranch; 3. attachment membrane of outer demibranch; 4. outer surface of ascending lamella of outer demibranch; 5. cut edge of demibranch; 6. outer surface of descending lamella of outer demibranch; 7. attachment area and blood vessel; 8. interlamella septum; 9. attachment membrane of inner demibranch; 10. ascending lamella of inner demibranch; 11. descending lamella of inner demibranch (see also Fig. 8A, B). B) Diagrammatic enlarged section of demibranch. 12. interlamellar septum; 13). interfilamental space; 14. filaments; 15. interfilamental junctions. C) Diagrammatic sketch of posterior siphonal area (see also Fig. 6E). 1. posterior adductor muscle; 2. right outer mantle lobe; 3. fusion of inner mantle lobes; 4. anus; 5. excurrent siphon; 6. incurrent siphon; 7. papillae around incurrent siphon; 8. "sensory knob" or "button"; 9. open mantle cavity; 10. muscular portion of mantle attachment; 11. left outer mantle lobe.



face of anterior pedal retractor muscle and directly above mouth, closely juxtaposed and connected by very short supraesophageal commissure. Pallial nerves arising from anterior portion of cerebral ganglia and giving off branches to anterior adductor muscle. Neither buccal ganglia nor labial palp nerves observed. Cerebro-visceral connectives arising from posterior lateral regions of cerebral ganglia and coursing posteriorly along sides of visceral mass to connect with visceral ganglia anterolaterally. Pleural ganglionic thickenings present on the cerebro-visceral connectives near the junction of esophagus with stomach. Cerebro-pedal connectives arising from anterior lateral region of cerebral ganglia and passing posteroventrally into foot and enter dorsal surface of partially fused, but distinctly bilobate pedal ganglion. Branches innervating intrinsic foot muscles and deep portions of anterior pedal retractor muscle arising from connectives. Fused pedal ganglia giving rise to three pairs of nerves: 1) ventral pedal nerves dividing into medial and lateral rami serving distal papillose portions of foot; 2) posterior pedal nerves bifurcating into medial and lateral branches and innervating posterior intrinsic muscle, deep portions of posterior pedal retractor muscle and byssal gland; and 3) long anterior nerves terminating in hollow bulb-like statocyst with refractive granular statolith. Paired visceral ganglia, partially fused, and located on anterior surface of posterior adductor muscle. Branchial nerves arching anteriorly from lateral portion of visceral ganglia and recurving to innervate axes of ctenidia. Visceral ganglia giving rise posteriorly to large pallial nerves with numerous branches to posterior adductor muscle and dorsal mantle. Pallial nerve ventrally bifurcating to form outer and inner circumpallial nerves, sending numerous discrete branches to excurrent and incurrent siphons and associated sensory structures as well as extending along ventral mantle margin. Two small protuberances on ventral surface of posterior adductor muscle and closely associated with visceral ganglia probably represent abdominal sense organs.

*Remarks.* As a member of a family of typically burrowing infaunal bivalves, *Calyptogena magnifica* is an unusual species not only for its size but for its remarkable ability to exploit a unique epifaunal niche, nestled in crevices and among mussels surrounding the abyssal hot vents.

This new species, on the basis of shell characters, is most closely related to *C. elongata* but differs in attaining greater size, having the umbos located more posteriorly and having a much larger ligament and longer nymphal callosity (see Fig. 12 for a comparison of these characters). In addition, the periostracum of *C. magnifica*, even in very small specimens does not remain on the disc though it may be present as a large "ruffle" along the anterior margin (see Fig. 4C–D). In *C. elongata* the periostracum is thinner and persists over the entire valve (compare Fig. 12A and 12D). In addition when comparing specimens of the same size the cardinal dentition is much coarser though similar in *C. magnifica*.

This new species is also closely related to *C. modioliforma*, but differs in being much larger, having the umbos more posterior, being more elongate and having the periostracum on the margin of the valves more highly developed. The dentition of *C. modioliforma* tends to be more blunt, thickened, and relatively more extensive than in *C. magnifica*. In addition, as *C. magnifica* increases in size, the subumbonal cardinal tooth tends to curl upwards (Fig. 10F–G).

Anatomically, *C. magnifica* resembles *C. pacifica* and *C. kilmeri*—the only species of *Calyptogena* for which we have any knowledge of the soft parts (Bernard, 1974). The elaborations of the mantle folds, comparable to those in other heterodont bivalves (Yonge, 1957) appear to be even more strongly differentiated in *C. magnifica* than in *C. pacifica* or *C. kilmeri*. Sensory papillae along the anterior mantle folds and an extensive periostracal border anteriorly are characteristic of *C. magnifica* (Figs. 4C, D, 5, 6A, B).

The mantle thickenings in the anterior ventral region of *C. magnifica* are more highly

FIG. 8. *Calyptogena magnifica* Boss & Turner. A) Closeup of posterior end of external surface of left ctenidium to show smooth ventral margins and texture of demibranchs (see also Figs. 6 and 7). B) Dorsal view of left ctenidium to show: a, outer surface of ascending lamella of outer demibranch; b, connecting membrane to mantle; c, inner surface of descending lamella of outer demibranch; d, ctenidial axis with blood vessel and muscle; e, inner surface of descending lamella of inner demibranch; f, inner surface of ascending lamella of inner demibranch (see also Fig. 7A, B). C) Closeup of ctenidial muscle (see also Fig. 5).

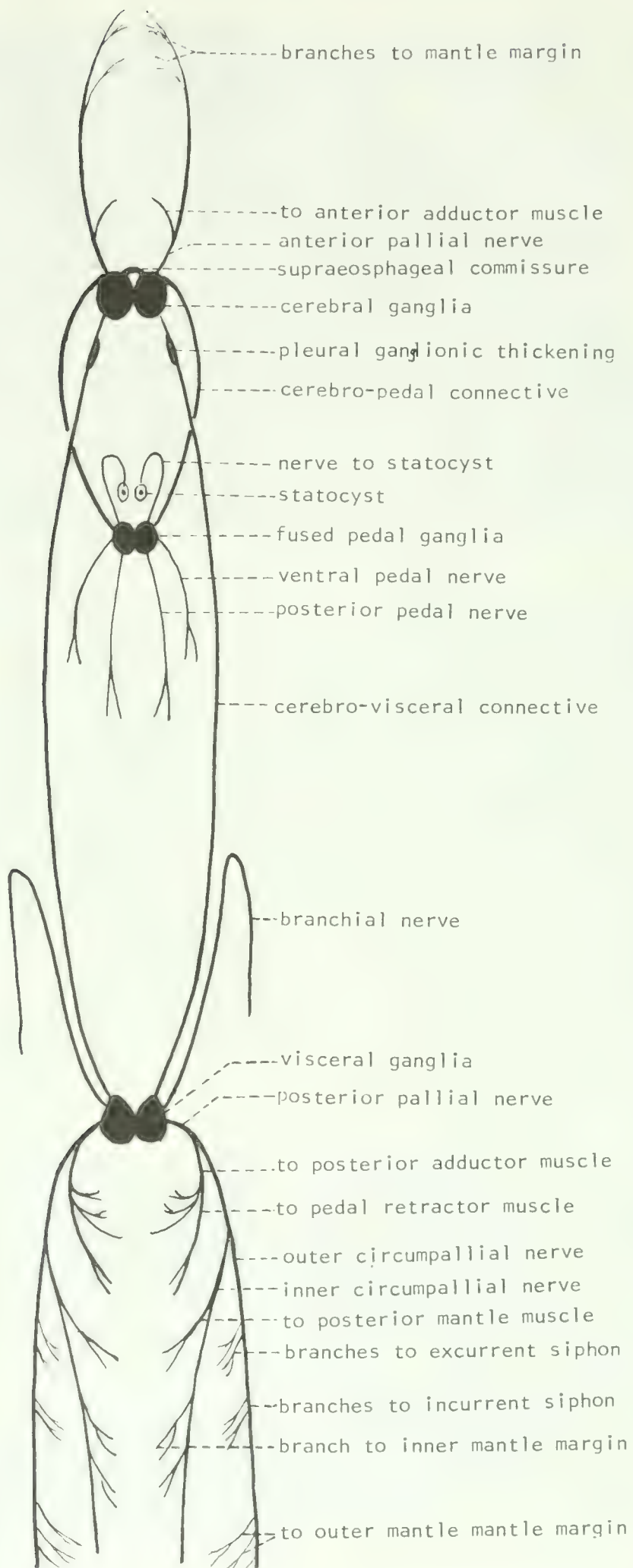

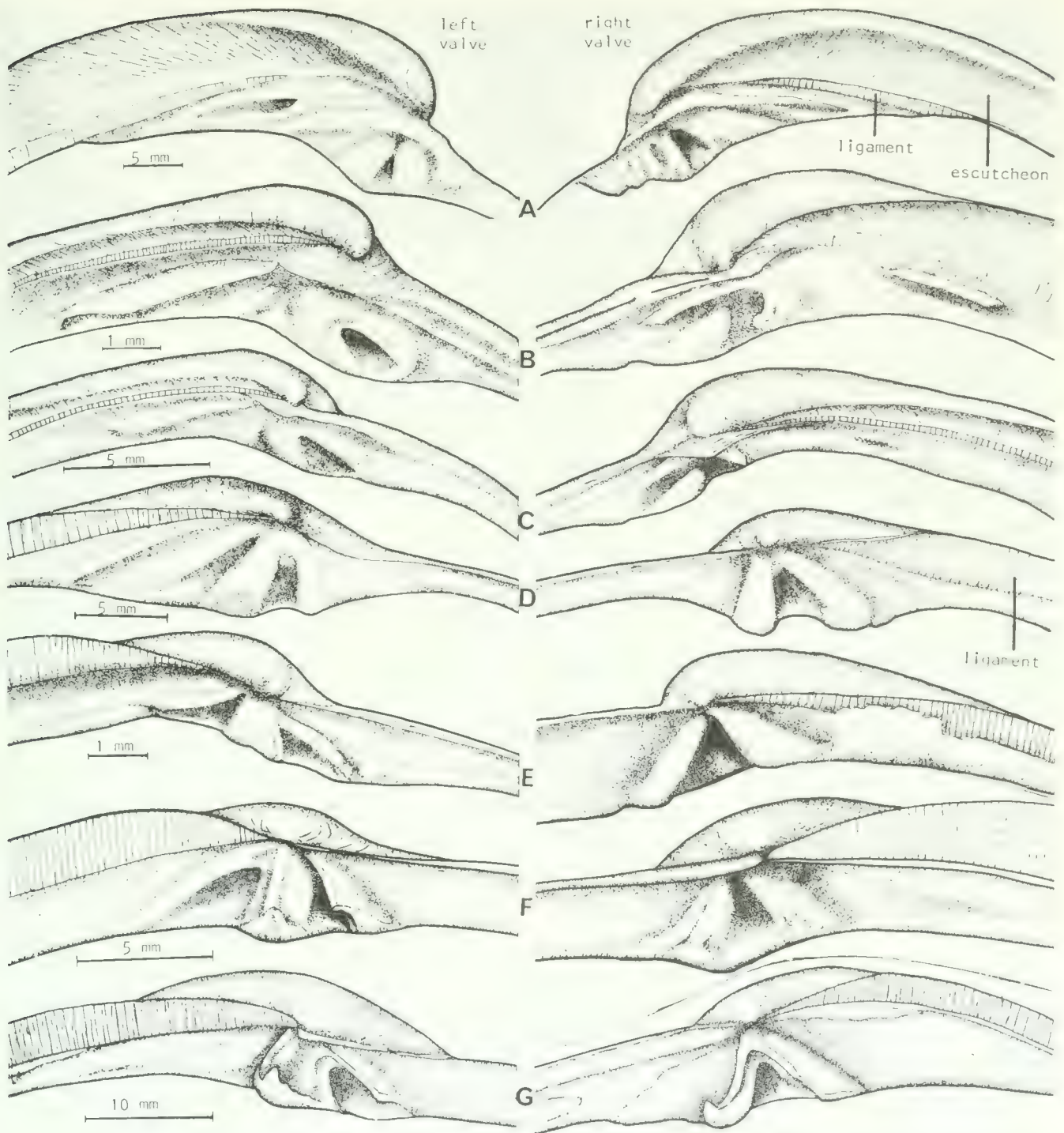

FIG. 10. The hinge and ligament of *Calyptogena*. A–C) Species in *Calyptogena*, s.s. Note small ligament and the presence of an escutcheon. D–G) Species in the subgenus *Ectenagena*. Note the presence of a large ligament and the lack of an escutcheon. A a, b) *C. (Calyptogena) ponderosa* Boss. Holotype, Oregon I, sta. 1426, 29°07'N; 87°54'W, about 77 mi. S of Mobile Bay, Gulf of Mexico, in 1097 m. B a, b) *C. (Calyptogena) pacifica* Dall. Syntype, Albatross sta. 3077, Clarence Strait, Dixon Entrance, Alaska, 55°46'N; 132°24'W, in 580 m. Young specimen 30.5 mm long. C a, b) *Ibid.* Adult specimen 47.5 mm long. D a, b) *C. (Ectenagena) modioliforma* Boss. Holotype, Pillsbury sta. 394, 9°28.6'N; 76°26.3'W; Golfo del Darien, 66 mi. NNE of Punta Caribana, Colombia, in 421–641 m. E a, b) *C. (Ectenagena) elongata* Dall. Holotype, off Point Loma, California, in 486 m. Specimen 44 mm long. F a, b) *C. (Ectenagena) magna* Boss & Turner, Galapagos Rift, ALVIN dive 892. Specimen 82.5 mm long. G a, b) *C. (Ectenagena) magna* Boss & Turner, Galapagos Rift, ALVIN dive 896. Specimen 130.6 mm long.

FIG. 9. Diagrammatic sketch of the nervous system of *Calyptogena magna* Boss & Turner from the dorsal aspect. (See Fig. 5 for the lateral view of the essential elements of the nervous system.)

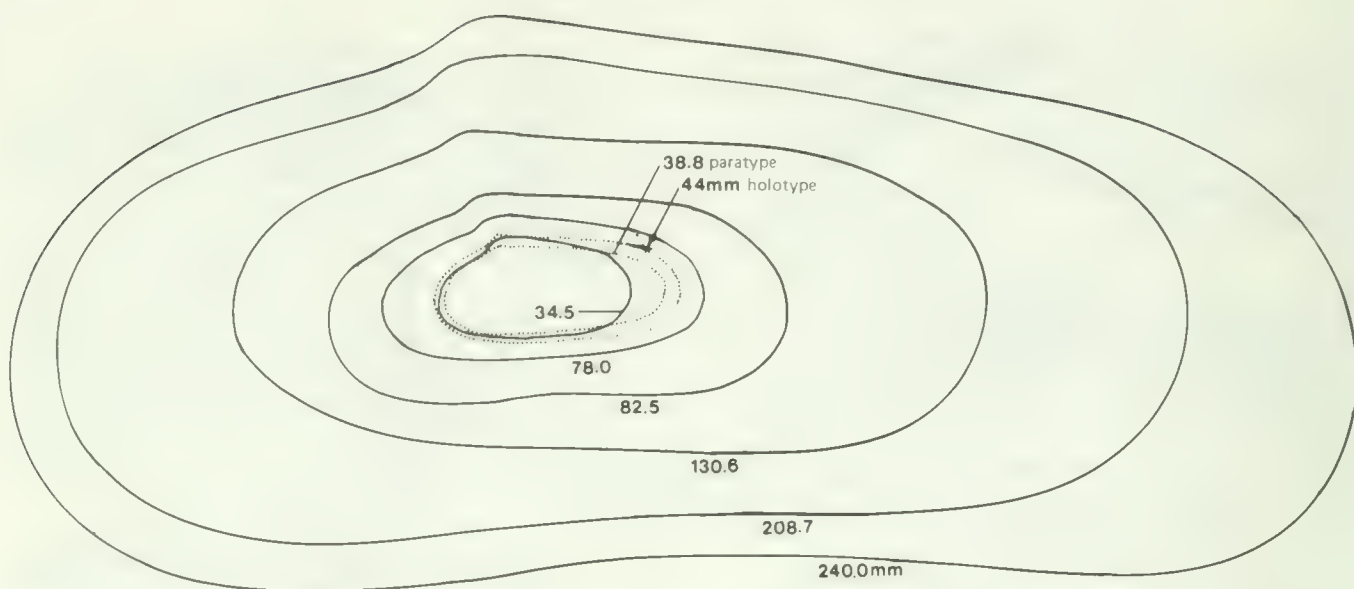

FIG. 11. Inset outlines of a graded series of valves of *C. magnifica* Boss & Turner obtained from the Galapagos thermal vents (in solid lines) as well as the holotype and paratype of *C. elongata* Dall (in dashed lines) to show the gradual increase in the curvature of the ventral margin with increase in size and the proportional difference in shell length and height position of the umbos in *C. magnifica* and *C. elongata*.

developed than in either *C. pacifica* or *C. kilmeri*, and may be similar in function to the so-called 'pallial gills' or 'Mantelkiemen' of the Lucinacea (Duvernoy, 1853; Semper, 1880; Pelseneer, 1911; Allen, 1958) or to the pallial glands of carditaceans, which function in the cleansing of the mantle cavity (Pelseneer, 1911; Harry, 1966; Allen, 1968; Yonge, 1969). In *Calyptogena*, however, neither special transverse folds nor definitive pallial blood vessels leading directly to the auricles, as in the lucinids, are apparent though some kind of secondary respiratory function may be surmised. It seems possible that this region in *C. magnifica* even though it is not between the outer and middle mantle folds (Figs. 4C, D, 6A), is developed for the massive production of periostracum, which may protect the anterior end of the valves against the environment of the hot vents or assist, perhaps, in maintenance of position. The region might also be similar in function to the anterior mantle thickenings or pallial mucous glands found in the Saxicavacea (Yonge, 1971).

Bernard (1974: 13) described as hypertrophied the posterior portion of the thickened mantle musculature of *C. pacifica*. The impression on the valves of this extensive posterior development is variable and has been called, by numerous authorities, the 'pallial sinus.' The siphons of vesicomysids are not greatly extendable and the radiating fan-like siphonal retractor muscles which form the pallial sinus in so many families of bivalves (Pelseneer, 1891; Boss & Kenk, 1964) are not present.

The so-called 'pallial sinus' is a dubious character for taxonomic discrimination in *Calyptogena* or other vesicomysids, but in a group with few differentiating features, this character may have to be employed. As can be seen from Figs. 2B, C, 3B, the 'pallial sinus' is only a reflection of the extent, in an anterior-posterior axis, of the thickening or hypertrophy of the edge of the mantle. The 'pallial sinus' of *C. magnifica* is 14% of total shell length while in *C. pacifica* it is 22%. Unfortunately, when the internal surface of the shell is glossy, the configuration and extent of the 'pallial sinus' is difficult to determine.

The sensory papillae of the mantle edge are protrusible posteriorly in the siphonal region and anteriorly in the vicinity of the maximum periostracal development. The fused inner lobe of the mantle ventral to the incurrent siphon forms an extrusible velum in *C. pacifica* and *C. kilmeri* (Bernard, 1974). The same appears to be true for *C. magnifica*. The "sensory knob" beneath the incurrent siphon (Figs. 6E, 7C) is similar to the "sensory button" in *Thyasira* (Allen, 1958: 435, fig. 10b).

In *Calyptogena*, as with many bivalves (Yonge, 1962), the byssus may be functional only during settlement and in the young stages. The foot, capable of protrusion beyond the valves, probably functions in locomotion and positioning. In contrast to the rather smooth pedal integument found in *C. pacifica* and *C. kilmeri* (Bernard, 1974), the foot of *C. magnifica* is highly rugose, roughened, or subpapillose with the distal portion containing glandular structures. Since most species of

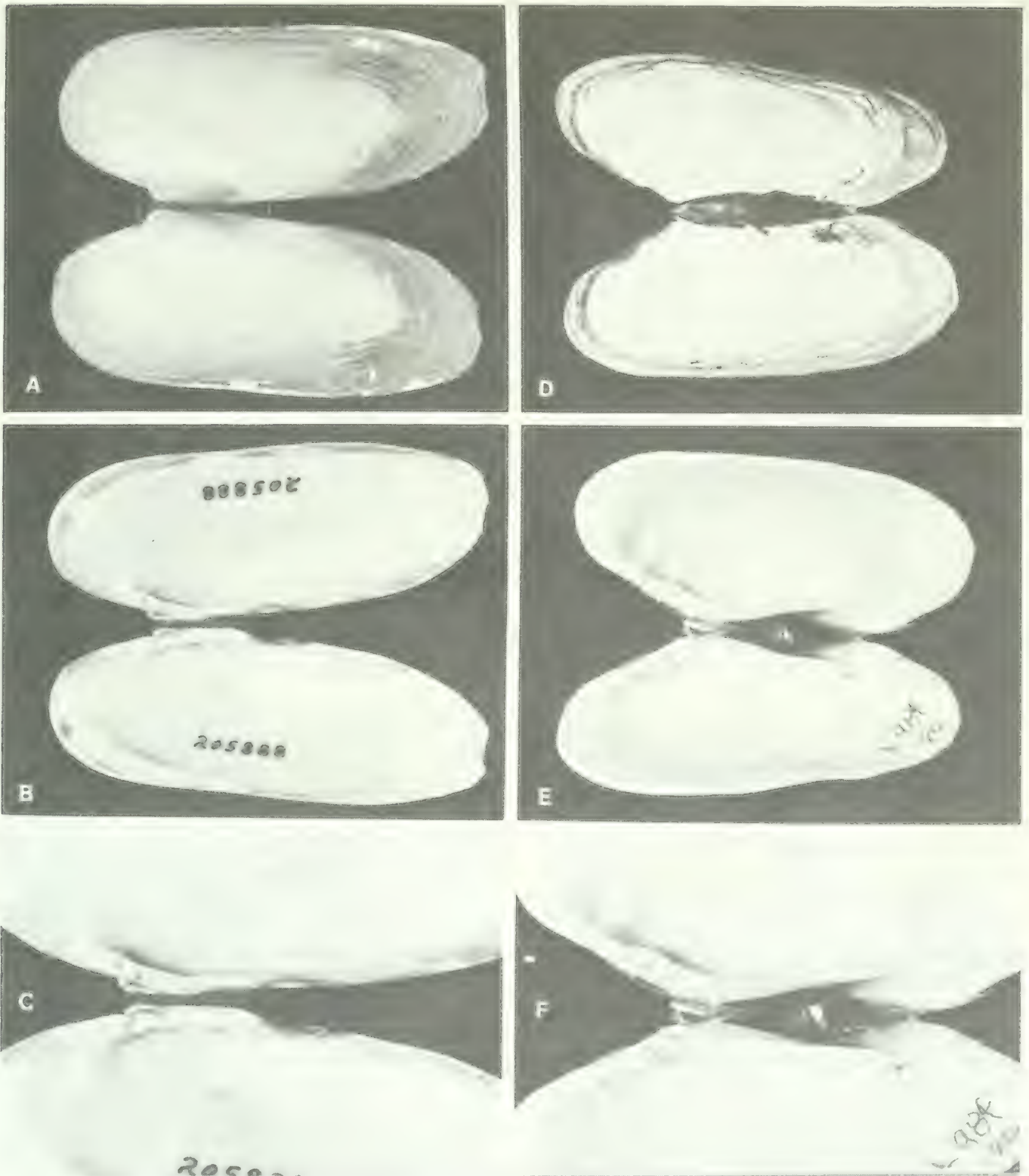

FIG. 12. Comparison of *Calyptogena elongata* Dall and *C. magnifica* Boss & Turner. A–C) *Calyptogena elongata*, paratype USNM 205888 (Albatross sta. 4432, off Point Loma, California, in 275 fathoms, 8 mi. S of Brockway Point, Santa Rosa Id., Channel Ids. (see also footnote 2). A) Outer view of valves to show position of the umbos in the anterior  $\frac{1}{4}$  of the valves and retention of the periostracum. B) Inner view of valves to show hinge and position of the relatively weakly impressed muscle scars. C) Close-up of hinge area to show small ligamental area (specimen 38.8 mm long). D–F) *Calyptogena magnifica*, paratype MCZ, ALVIN Dive 984,  $0^{\circ}48.24'N$ ;  $86^{\circ}13.47'W$  in 2450 m. Galapagos Rift. A) Outer view of valves showing lack of periostracum except on the edge of the valves, the position of the umbos at the anterior  $\frac{1}{3}$  of the valves and the large ligament extending the length of the posterior dorsal margin. B) Inner view of valves showing the large cardinal teeth, the large ligament and the well-impressed muscle scars. C) Close-up of the hinge area to show the large ligament and the shelf bordering it (specimen 34.5 mm long). (Photographs by R. D. Turner and C. B. Calloway.)



FIG. 13. Dense set of large white clams (*Calyptogena magnifica* Boss & Turner). Photograph taken on ALVIN Dive 909, 20°51.9'N; 109°4.4'W, in 2645 m, about 200 mi. W of Punta Mita, Mexico. (Photograph by Bruce Luyendyk, University of California, Santa Barbara.)

*Calyptogena* are assumed to burrow, the differentiation of the foot of *C. magnifica* may be a specialization for living on hard substrates nestled in cracks and crevices or among other organisms, especially large mytilids also found around the hot vents.

The reduction of the labial palps to mere lip-like folds above and beneath the mouth is typical of *Calyptogena* and probably of other vesicomysids (e.g. *Callogonia*) (Boss, 1969a; Bernard, 1974). Thiele and Jaeckel (1931), describing *V. striata*, noted: "Die Mundlappen sind schmal und ziemlich kurz." Thiele (1935) incorporated that observation in his remarks on the family Kellyellidae (sic) in which he included *Vesicomys*. However, reduction or loss of labial palps, usually correlated with reduced selection of particulate food, is a secondarily derived feature convergent in several distinct lineages of bivalves: lucinids (Thiele, 1886: 247, fig. 23; Purchon, 1939; Allen, 1958), limids (Stuardo, 1968); dimyids (Waller, 1978; Yonge, 1978b), mytilids (Yonge, Goreau & Goreau, 1972) and teredinids (Turner, 1966).

*Calyptogena* shows a reduced palp config-

uration similar to that of *Phacoides* (Allen, 1958: fig. 39) and is unlike other primitive heterodonts such as *Astarte* (Saleuddin, 1965) or the isocardiacean *Glossus* (Owen, 1953) with fully developed palps.

The ctenidia of vesicomysids were originally described by Dall (1895a: 505; 1895b: 696) as being protobranch-like, thick and fleshy, lacking both interlamellar septa and a completed anal or epibranchial chamber. He thought that the gills, though fused distally to the siphonal septum, were not fused to each other. Ridewood (1903: 224–226, fig. 23) disagreed with Dall and showed that the gills of *V. stearnsi* were eulamellibranch with small outer demibranchs and closely packed filaments. He stated that in *V. stearnsi* the ascending lamellae of the outer demibranchs were not fused to the mantle nor were the gills fused to each other posteriorly but pointed out that the gills were so rigid that they would 'readily come away from adjacent parts even if organically united to them.' Such a configuration is certainly not true of *C. magnifica*. We were able to see the connections before beginning the dissection; however, these quickly



separated, leaving no evidence of connections. The interlamellar septa in *V. stearnsi* are weak, and the ctenidia readily separate into plates. In contrast, the interlamellar septa in *C. magnifica* (Fig. 7B) are strong and hold the lamellae of the demibranchs together. According to Bernard (1974), neither *C. pacifica* nor *C. kilmeri* possess interlamellar septa.

Ridewood (1903) concluded that *Vesicomys* resembled *Lucina* rather than the Protobranchia but it is probable that the similarities are, in part, convergent as both these genera have long geological histories, especially lucinids which date from the Paleozoic. In fact the ctenidia are rather poor distinguishing familial taxobases in lamellibranch bivalves. Ridewood himself (1903: 186) was unable to give diagnoses for the numerous suborders he employed, much less discriminating features of individual families.

The placement and gross structure of the kidney of *C. magnifica* conforms with the type found in eulamellibranch bivalves as described by Odhner (1912) and is similar to that of *Kelliella miliaris* (Clausen, 1958).

According to White (1942), pericardial glands function to excrete acids from the blood either through blood sinuses in the mantle or through the wall of the pericardium and auricles. Products discharged into the pericardial cavity pass through the renopericardial aperture and are extracted by the kidneys. In *C. magnifica* the pericardial glands, consisting of differently colored moieties, lie mostly on the floor of the pericardium; the ventricle is tubular and embraces the rectum. This morphology is unlike that of the Carditidae, with which vesicomysids have sometimes been placed in that the ventricle of carditids lies mostly beneath the rectum (White, 1942).

In *Arctica*, both White (1942 [as *Cyprina*]) and Boltzmann (1906) noted the extensive development of the pericardial gland within the pericardium and anteriorly over the visceral pedal mass in the mantle. However, unlike that of *Calyptogena*, the ventricle in *Arctica* is short and rectangular; the renopericardial apertures are on the posteroventral wall of the pericardium.

In its general anatomy, the nervous system of *Calyptogena magnifica* does not differ significantly from most eulamellibranchs (Lammens, 1969; Bullock & Horridge, 1965). Unlike the statocysts of *Kelliella miliaris*, which are close to or incorporated in the pedal ganglion (Clausen, 1958), the statocysts in

*Calyptogena* are large, well-developed and located in the foot some distance from the pedal ganglia (Fig. 5).

Specimens available to us were not in proper condition for detailed work on the reproductive system and no previous descriptive work is known; however, sections taken in the visceral mass just anterior to the pericardium and dorsal to the stomach showed the presence of numerous, large, yolky oocytes, measuring 150–195  $\mu\text{m}$  in greatest diameter, in germinal vesicle stage.

On the basis of anatomical evidence, *C. magnifica* can be separated from *C. pacifica* and *C. kilmeri* by the development of strong interlamellar septa between the lamellae of the demibranchs. Lesser features in *C. magnifica* include the glandular structure on the surface of the foot, the more extensive development of the anterior portion of the edge of the mantle and the greater proliferation of the periostracum. Possibly the pericardial glands may differ from those of *C. pacifica* which are prolonged anteriorly (Bernard, 1974), but it is not known whether they enter the visceral mass or mantle tissue.

#### APPENDIX 1. Description of living specimens of *Calyptogena magnifica* Boss & Turner with notes on their distribution and ecology

Carl J. Berg and Ruth D. Turner

During the 1979 Biological expedition to the thermal vents of the Galapagos Rift (LULU-ALVIN Cruise 102, leg 9 and Cruise 103, leg 5) we made observations on living *Calyptogena magnifica* to supplement the description of the species by Boss & Turner based on preserved specimens. We made observations of specimens in situ from ALVIN, of specimens maintained in the aquarium aboard LULU, while taking samples for histological and electrophoretic studies, while preparing valves for age determinations, and while preserving the soft parts for anatomical studies. Additional data on distribution, orientation and behavior of the large white clams were obtained from discussions with other scientists who had visited the sites in ALVIN as well as from videotapes and photographs taken on the various dives. During these two series of dives 61 living *Calyptogena magnifica* were collected, 15 on Cruise 102 and 46 on Cruise 103. Specimens ranged in size from 34.5 to 241 mm in length, the largest ones (188–

241 mm in length) were taken at the vent named "Mussel Bed" (0°48.5'N; 86°09.0'W in 2480 m and the smaller ones (34.5–151 mm in length) from "Rose Garden" (0°48.3'N; 86°13.8'W in 2450 m). The smaller size of the white clams, the lighter color and smaller size of the mussels combined with the abundance and great size of the vestimentiferans at "Rose Garden" suggest that this may be the younger and more active of these two vent areas. Although large groups of empty clam shells were seen at most of the vents, the living clams were scattered and in small groups, usually of ten or fewer. They were nestled among dead clams, living mussels or in rock crevices, usually oriented in a nearly vertical position, the iridescent pink mantle and the openings of the siphons often showing between the slightly gaping valves. This suggests that larval clams settle in the presence of other clams and/or in response to warm water issuing from the fissures in the lava rock and that, as they grow, they maintain a position with the foot probing for warmth.

The clams were never observed with the valves more than slightly gaping and they would often remain closed for long periods of time, particularly in the aquarium. The mantle of living specimens is an iridescent purple-pink, the papillae on the incurrent siphon yellowish. In situ observations showed that the siphons opened and closed frequently, that they could be extended slightly but that they never extended beyond the valves. They are capable, however, of forcibly ejecting material a distance of at least 30 cm from the siphonal aperture.

A yellowish, transparent, tough and stretchy, plastic-like periostracum extends from the periostracal groove of the mantle margin out over the valve protecting the growing edge of the shell. When removing the soft parts from the valves it was necessary to cut this with scissors so firmly was it attached to the outside of the valve and to the mantle. It appeared as a brown wrinkled border along the margins of the valves, being thin posteriorly and increasing to multiple ruffles at the anterior end.

An isolated specimen, possibly disturbed by ALVIN activity was observed lying on its side at the edge of a cluster of clams. The specimen, approximately 150 mm in length, had extended its foot about half the length of its shell but showed little activity except weak probing movements during the half hour it

was in view (while the pilot was picking up microbiological experiments for return to the surface). The foot was lighter but similar in color to the mantle and appeared smooth. Specimens brought to the surface, however, all appeared to have a strongly rugose foot, a condition which might be due partly to contraction and/or reduction in pressure. The rugosities were blister-like and when punctured released a clear fluid. The foot of a specimen kept for two days in the aquarium, maintained at about 2°C, became less rugose, and the foot of one maintained under pressure became smooth, suggesting the possibility that these clams have some ability to adapt to changes in pressure. The proximal half of the foot, visible only after the shell has been opened and the mantle and gills turned back, is smooth light brown and streaked with dark red blood vessels. Small clams are lighter in color and have a cream-colored foot reminiscent of *Mercenaria*.

The ctenidia in large, newly collected specimens are light brown with pronounced zigzag longitudinal streaks of red and finer, more-or-less vertical mottlings of reddish-brown. These markings are perhaps a reflection of the 'herring-bone' configuration of the gill filaments described by Boss & Turner. The ventral margins of the ctenidia were a purple-pink and there was a grayish line at the junction of the inner demibranch with the visceral mass. The gills of small clams were a uniform cream color. Many clams had notches on the posterior ventral margin of the outer gills, the number varied from one to three and was not necessarily the same on both sides of the animal. We have no explanation for these notches which occurred on clams found at all vents from which material was collected.

The large white clams, unlike the mussels commonly found around the vents, have red blood, which gives a red appearance to the animals when the shell is opened. The red pigment is intracellular, and is a haemoglobin but it has not been fully characterized as yet. The pericardial region has a dark red coloration which extends laterally down to the ctenidia. No pumping of the heart was observed, nor did the blood spurt when the clams were cut or when blood samples were taken. The non-muscular portion of the mantle was thin, nearly transparent and reddish-brown. Small specimens are much lighter in color than the larger ones but the red color of all specimens increased with time as they remained in the aquarium.

The position of the gonads, though typical for bivalves, cannot be determined by general examination of the body surface even in living specimens, probably due to the overall red coloration of the animal. Dissection and histological examination of specimens collected in February 1979 showed ova in all stages of development and yolky eggs 309  $\mu\text{m}$  in diameter. Eggs found lying free in a jar with a preserved clam ranged from 364–482  $\mu\text{m}$  in diameter. These data suggest that *C. magnifica* releases large yolky eggs.

The clams did not react when crabs or shrimp crawled over their shells and touched the mantle but they closed slowly when handled by the submarine's manipulator. Crabs are obviously not predators on the larger clams though they may feed on young specimens. Octopus have been seen at the vents and are suspected predators on the larger clams.

APPENDIX 2. Annotated list of fossil and living species currently referable to  
*Calyptogena*

Kenneth J. Boss

?*Calyptogena akanudaensis* Tanaka

*Calyptogena akanudaensis* Tanaka, 1959: 119, pl. 2, figs. 1–8; Hanzawa, Asano & Takai, 1961: 219 (type-locality, cliff along the mountain-side, about 1.5 km E of the Nishikibe Elementary School, Shigamura, Higashi-Chikuma-gun, Nagano Prefecture, Bessho Formation, Miocene; Holotype, no. 510; paratypes, nos. 524–531, Geological Institute, Faculty of Education, Matsumoto Branch, Shinshu University); Okutani, 1966b: 301).

*Remarks.* Despite considerable efforts, we have not been able to obtain the original reference and follow Okutani (1966b: 301) in considering this species, though initially referred to *Calyptogena*, as a questionable member of the genus.

*Range.* Fossil in Miocene of Japan.

*Calyptogena (Calyptogena) chitanii*  
(Kanehara)

*Adulomya chitanii* Kanehara, 1937: 19–20, pl. 5, figs. 1, 6, 7, 8, 9 (localities, Ashikaya-Zawa, Sekinami-mura; Takai and Nakosonoseki, Sekimoto-mura; Hatanaka Shizuzaku, Izumi-mura; Nishinakada, Watanabe-mura; geological horizon, Mizunoya Shale, Kamen-

owo Shale, Yunagaya Series; Shirado Series; [Jôban coal field, Fukushima Prefecture, Japan, Miocene; for type-specimens, see Hanzawa, Asano & Takai, 1961: 211); Aoki, 1954: 31–32 as "*Adulomya*," pl. 1, figs. 9, 10, 11 (localities, cliff of small valley, Dônosaku, Kamikatayose, Kabeya and small cliff of path-side in small valley of Kamikatayose, Kabeya. Kabeya Formation [Ishimori district, Jôban coal field, Fukushima Prefecture, Japan; Miocene]); Hanzawa, Asano & Takai, 1961: 211 (type-locality, Ashikaya-zawa, Sekinami-mura, Jôban coal field, Fukushima Prefecture, Mizunoya Shale, Miocene; holotype and paratype, Geological Survey, Japan); Kamada, 1962: 39–41 (localities, Shisawa, Nakoso City. Kamenoo Formation; Fukuda, Sekinami, Kitaibaraki City. Kamenoo Formation; Nagako, Nishikimachi, Nakoso City. Kamenoo Formation; Kanegasawa, Hisanohama-machi. Kamenoo Formation; Tangozawa, Shiroyama, Taira City. Honya Formation; northern cliff of Taira railroad station, Shiroyama, Taira City. Honya Formation. Yagawase cliff, Taira City. Honya Formation; Tsuruga-machi, Iino, Taira City. Misawa Formation [Jôban coal field, Fukushima Prefecture, Japan, Miocene]).

*Akebiconcha chitanii* (Kanehara). Kanno & Ogawa, 1964: 285–286, pl. 1, figs. 17–18 (upper part of the Takinoue Formation [Hokkaido, Japan]); Kanno, 1967: 401–402, pl. 1, figs. 9–11, 15 (Itsukaichi [machi group] Basin, Tokyo Prefecture; Miocene).

*Calyptogena chitanii* (Kanehara). Kanno, 1971: 80–82, pl. 7, figs. 5, 6a–b; pl. 17, fig. 12, text-figs. 10, 11, and 12 (Kayak Island [Alaska], Yakataga Formation [upper middle Miocene or upper Miocene]).

*Remarks.* We include this species in *Calyptogena* following its placement there by Kanno (1971), who figured the hinge, showed the range of its allometric change in shape, documented its extensive occurrence in the fossil record, and contrasted it with both *C. elongata* and *C. pacifica*. Probably referable to *Calyptogena*, s.s., *C. chitanii* is similar to *C. pacifica*, especially in regard to the dentition of its left valve (contrast Kanno, 1971: text-fig. 10, nos. 2, 3 with Fig. 10, Ba, Ca). Representing a Miocene ancestor of *Calyptogena* in the northern Pacific Basin, *C. chitanii* is apparently separable from *C. pacifica* only by its more narrowly elongate and arcuate form; further distinctions might be made in regard to the development of the escutcheon and nature of the dentition of the right valve, if suites of

specimens were available for comparative analysis.

*Range.* Miocene (upper middle or upper) in Alaskan and Japanese formations [Kamenoo Formation, Itsukaichi-machi group, Honya Formation, Kabeya Formation, Takinoue Formation, and Yakataga Formation] (see Kanno, 1971).

*Calyptogena (Ectenagena) elongata* Dall

*Remarks.* See text, p. 164.

*Calyptogena (Calyptogena) kawamurai elongata* (Ozaki)

*Akebiconcha kawamurai elongata* Ozaki, 1958: 123, pl. 5, figs. 3, 4, pl. 6, figs. 1–5 (cotype from Ebishima (type-locality, small islet off Inuwaka, Tyôsi, Na-arai Formation (Lower Pliocene) and paratype from roadside cutting in front of Electric Car Station of Zinmuzi, Miura Peninsula, Kanagawa Prefecture; Ikego Formation (Lower Pliocene) *non* Dall, 1916; Hanzawa, Asano & Takai, 1961: 221 (syntype from Ebishima, off Inuwaka, Choshi City, Na-arai Formation (Miocene); Shikama, 1962: 53; Okutani, 1966b: 301 (Pliocene).

*Remarks.* This is a synonym of *C. kawamurai*, *C. nipponica* and probably *C. soyoae*, and, since it was originally described in *Akebiconcha*, it became, when transferred to *Calyptogena*, a secondary homonym of *C. elongata* Dall; the population named by Ozaki (1958) constitutes only an individual variation (Shikama, 1962).

*Calyptogena (?Calyptogena) gibbera*  
Crickmay

*Calyptogena gibbera* Crickmay, 1929: 93, 1 fig. (type-locality, lowest bed of the Santa Barbara Formation, on Deadman's Island, near San Pedro, California [Pliocene]; Woodring, 1938: 51 (early Pleistocene silt of Deadman's Island [Arnold's Pliocene; Alex Clark's Timms Point Formation]); Woodring, Bramlette & Kew, 1946: 83.

*Remarks.* When naming this species, Crickmay (1929) compared it with *C. elongata* and *C. pacifica*, though the hinge was not described and therefore a subgeneric placement is uncertain; however, *C. gibbera* very much resembles *C. pacifica*, especially in its size, proportions and gross outline (52 × 29 × 15 mm) and is probably synonymous with *C.*

*pacifica*; it differs from *C. elongata* in not being narrowly elongate.

*Range.* Pleistocene, Deadman's Island, California.

*Calyptogena (Calyptogena) kawamurai*  
(Kuroda)

*Akebiconcha kawamurai* Kuroda, 1943: 17, text figs. 1–3 (type-locality, off Odawara, Sagami Bay, in about 100 fathoms); Habe, 1952: 159, pl. 22, figs. 20–31; Hatai & Nisiyama, 1952: 33 (as synonym of *Calyptogena nipponica*); Habe, 1961: 122, pl. 55, fig. 16 (100–200 m, Sagami Bay); Okutani, 1957: 28; Ozaki, 1958: 124, pl. 3, figs. 1–3, pl. 4, figs. 1–3, pl. 5, figs. 1, 2 (Kashima-Nada); Okutani, 1962: 23 (700–750 m, Sagami Bay); Okutani, 1966b: 301; Shikama, 1962: 53, pl. 3, figs. 6a–d, 7a–c (about 46 miles east to southeast of Chôshi, 200–230 fathoms); Habe, 1968: 179, pl. 55, fig. 16 (100–600 m in Sagami Bay to Kashima-Nada, Honshû); Habe, 1977: 237, pl. 50, figs. 3–4.

*Calyptogena kawamurai* (Kuroda). Bernard, 1974: 18.

*Remarks.* The original Japanese description of *C. kawamurai* by Kuroda (1943) has been rendered into English by Ozaki (1958). The nomen is a synonym of *C. nipponica* as indicated by Hatai & Nisiyama (1952: 33). In all probability, *C. nipponica* will come to be recognized as the senior synonym of not only *C. kawamurai*, and *C. elongata* Ozaki, but of *C. soyoae* as well.

*Range.* Recent from Kashima-Nada and from off Chôshi to Sagami Bay, in 100 to 750 m.

*Calyptogena (Calyptogena) kilmeri*  
Bernard

*Calyptogena (Archivesica) kilmeri* Bernard, 1974: 17–18, text-figs. 1B, 2B, 3B and 4E (type-locality, off west coast of Moresby Island, Queen Charlotte Islands, British Columbia, Canada, in 1170 m).

*Remarks.* Bernard (1974) provides several additional localities besides the type-locality. Because of the similar nature of its dentition and the absence of any reliable distinguishing anatomical traits from *C. pacifica* (see Bernard, 1974: 18), we place *C. kilmeri* in *Calyptogena*, s.s. although we have not included *Archivesica* in the synonymy of *Calyptogena*. Bernard apparently utilized *Archivesica* for *C.*

*kilmeri* because of its relatively thin shell, stating "Archivesica . . . thinner shelled . . . modioliform . . . small pallial sinus." *Archivesica*, based on its type-species *Callocardia gigas* Dall, from the Gulf of California, may indeed be thinly shelled but it also can be thick and heavy (e.g. USNM 266874).

Previously, Boss (1967; 1968) related *Archivesica gigas* to such species as *Vesicomya caribbea* Boss from the Caribbean Sea, *V. chuni* Thiele & Jaekel from off West Africa, *V. winckworthi* Prashad from the East Indies and *V. leana* Dall from North Carolina to Tobago in the western Atlantic. One might also include: *V. angulata* Dall from Panama Bay, *V. longa* Thiele & Jaekel from the Gulf of Guinea and *V. suavis* from off Lower California. Thiele & Jaekel (1931) placed *V. chuni* in *Callogonia*, a procedure subsequently followed by Boss (1969a: 254; 1970: 69), who suggested that *Archivesica* might be considered a synonym of *Callogonia*.

Until we have a better understanding of the supraspecific categories of this group and although *Archivesica* may fall into the synonymy of *Calyptogena*, we presently consider it a synonym of *Callogonia*, and conserve that as a subgenus of *Vesicomya* for *Archivesica gigas* and its relatives as mentioned above. This group, which may have shells of variable thicknesses, usually shows inflation of the valves, a short prominent ligament with a concomitant subtending nymphal callosity; a demarcated escutcheon is lacking and the pallial sinus, or posterior sinuosity of the pallial line is slight but usually noticeable, and sometimes rather pointed or angled above.

*Range.* Living from British Columbia, Canada, to northern California (53°–40°N), in 549–1464 m.

*Calyptogena (Calyptogena) lasia*  
(Woodring)

*Phreagena lasia* Woodring, 1938: 50, pl. 5, figs. 3, 4, text-fig. 2a (type-locality, Standard Oil Co., Baldwin No. 73, Montebello field, depth 3340–3358 feet, United States Geological Survey locality 13864, Repetto Formation, Lower Pliocene, Los Angeles Basin; holotype, USNM 496097).

*Calyptogena lasia* (Woodring). Winterer & Durham, 1962: 295, 302, 307, 308 (Ventura Basin, Los Angeles County); Boss, 1968: 739.

*Remarks.* Woodring (1938) lists numerous additional localities for *C. lasia* in the Repello and Pico formations of the Los Angeles Basin

and discusses the relationship of this species with other vesicomysids, especially *C. pacifica* and *C. elongata*. Winterer & Durham (1962) add several other occurrences of *C. lasia* in the Ventura Basin. Woodring (personal communication) concurred in the synonymy of *Phreagena* and *Calyptogena*.

*Range.* Fossil in Lower Pliocene of Los Angeles and Ventura Basin, California.

?*Calyptogena longissima* (Yokoyama)

*Cucullaea longissima* Yokoyama, 1925: 20, pl. 3, fig. 1 (type-locality, Shigarami); Makiyama, 1958: pl. 27.

*Calyptogena longissima* (Yokoyama). Hatai & Nisiyama, 1952: 56 ([Shigarami] Pliocene, Shigarami [a short distance N of Shimosoyama, Shigarami-mura, Kami-Minouchi-gun, N. Nagano, 36°40'N; 138°04'E]; holotype, GT no. ?); Hanzawa, Asano & Takai, 1961: 233 (holotype, Geological Institute, University of Tokyo; Shigarami, Nagano Prefecture, Shigarami Formation, Pliocene); Okutani, 1966b: 301.

*Remarks.* We have followed several different Japanese authorities (Hatai & Nisiyama, 1952; Hanzawa, Asano & Takai, 1961), in placing this species in *Calyptogena*, *s.l.*, with some doubt as to the propriety of this assignation (Okutani, 1966b: 301). The species is based on an internal cast, measuring 115 × 55 × 35 mm, roughly shaped like a *Calyptogena*. The pallial line is distinctly visible, relatively wide, strongly impressed, and weakly sinuate posteriorly.

*Range.* Fossil in Japan, Shigarami Formation, which was considered Pliocene by Hatai & Nisiyama (1952: 332) and Hanzawa, Asano & Takai (1961); Okutani (1966b) cited its occurrence as Miocene.

*Calyptogena (Ectenagena) modioliforma*  
(Boss)

*Ectenagena modioliforma* Boss, 1968: 742–746, figs. 10, 21–24, 26–27 (type-locality, Pillsbury station 394, 9°28.6'N; 76°26.3'W, Golfo del Darien, 66 miles NNE of Punta Caribana, Colombia in 42–641 m; holotype, MCZ 256973).

*Remarks.* As noted earlier in the text, we no longer consider *Ectenagena* of generic rank and follow Keen (1969) in placing it as a subgenus of *Calyptogena*; *C. modioliforma* is the Caribbean homolog of *C. elongata* and a close living relative of *C. magnifica*.

*Range.* Known only from the holotype.

*Calyptogena moraiensis* (Suzuki)

*Unio moraiensis* Suzuki, 1941: 55, pl. 4, figs. 2–5 (type-locality Morai hard shale formation in Pliocene); Hanzawa, Asano & Takai, 1961: 293 (Holotype and paratype, Oilwell no. 2, Shunbetsu, Ishikari-machi, Atsutagun [sic], Hokkaido, Morai hard shale, Pliocene, Geological Institute, University of Tokyo).

*Calyptogena moraiensis* (Suzuki) Ôtatumé, 1942: 437 (Morai, Atuta-mura, Atuta-gun, Ishikari Province, Mio-Pliocene); Okutani, 1962: 23; Okutani, 1966b: 301.

*Remarks.* This is recognized as a synonym of Japanese fossils of Mio-Pliocene age from Hokkaido referred to *C. pacifica* Dall (Ôtatumé, 1942; Okutani, 1962; 1966b).

*Range.* Mio-Pliocene of Morai shale, Hokkaido, Japan.

*Calyptogena* (?*Calyptogena*) *nipponica*  
Oinomikado & Kanehara

*Calyptogena nipponica* Oinomikado & Kanehara, 1938: 677–678, pl. 21, figs. 1–5 (type-locality, Ushigakubi Bed, Lower Pliocene, Higashiyama Oil-field, Niigata Prefecture; range: Kubiki Bed, Niigata Prefecture [Mio-Pliocene]; Katsuura Bed, Chiba Prefecture [Pliocene]; Ôtatumé, 1942: 197 + 199; Hatai & Nisiyama, 1952: 33 (Ushigakubi Lower Pliocene [Miocene]). On the eastern bank of the Maekawa, about 1.2 km S of the village office at Nakamura, about 200 m W of the shrine at Shigebuko, Nishitani-mura, Koshi-gun, Niigata. Nagaoka, 37°24.30'N; 138°59'E; holotype and paratype destroyed; also Kubiki Miocene. The wall of the water well, 33 m deep from surface at the primary school, Nakanosawa, Higashiyama-mura, Koshi-gun, N; [Kojiya, 37°19'N; 138°52'E] paratype destroyed (is *Akebiconcha* cf. *A. kawamurai* Kuroda); Okutani, 1957: 218; Itoigawa, 1958: 251 (Teradomari Formation Kubiki Group, Upper Miocene, Higashiyama Oil-field, Niigata Prefecture); Hanzawa, Asano & Takai, 1961: 219, holotype and paratype, eastern bank of the river [Mae-kawa], about 1.2 km south of the village office of Nishitani-mura at Nakamura, Nishitani-mura, Koshi-gun, Niigata Prefecture, Ushigakubi Formation, Pliocene; Okutani, 1962: 23 as *Akebiconcha? nipponica* (Oinomikado and Kanehara); Okutani, 1966b: 301, Pliocene.

*Remarks.* Oinomikado & Kanehara (1938) established this species on specimens from

several Japanese localities of Miocene and Pliocene age. It is quite probable that, as indicated by Hatai & Nisiyama (1952), *C. kawamurai* Kuroda, 1943 and *C. k. elongata* Ozaki, 1958 are synonyms of *C. nipponica*. We suggest that even *C. soyoae* may be considered in this lineage and might prove to be synonymous if critical comparable suites were available.

Apparently, there are conflicting opinions concerning the primary type-material of *C. nipponica*. Hatai & Nisiyama (1952) noted that the holotype & paratype were destroyed, while Hanzawa, Asano & Takai (1961) cited both a holotype & paratype!

*Range.* Fossil species from the Miocene and Pliocene of Japan in Ushigakubi Bed, Kubiki Bed, and Teradomari Formation of the Kubiki Group in Niigata Prefecture and from the Katsuura Bed, Chiba Prefecture.

*Calyptogena* (*Calyptogena*) *pacifica* Dall

*Calyptogena pacifica* Dall, 1891: 190 (type-locality, Albatross Station 3077, off Dixon Entrance, Alaska, in 322 fathoms; 1895b: 713, pl. 25, figs. 4, 5 (holotype, USNM 122549); 1903a: 700, 712 (Pliocene and Recent); 1903b: 1435–1436 (Pliocene of Los Angeles, California; Recent, in Clarence Strait, southeastern Alaska); 1916: 408; 1921: 32 (Clarence Strait, Alaska to Santa Barbara Channel, California); Lamy, 1922: 349; Oldroyd, 1924: 116; Crickmay, 1929: 93; Grant & Gale, 1931: 278–279, pl. 13, figs. 13a–b (Pliocene, Los Angeles; blown out of big Amalgamated Gas well, from depth of 2500 feet with *Dendraster interlineatus* Stimpson, Wolfskill Lease, Salt Lake oilfield, near Beverly Hills, Los Angeles County (coll. by J. O. Lewis, 1912); Thiele, 1935: 848; Otuka, 1937: 231 (Wakimoto Bed, Pliocene of Oga Peninsula, Akita-ken, Japan); Oinomikado & Kanehara, 1938: 678; Woodring, 1938: 50–52 (in Clarence Strait, Alaska, in 322 fms.; off Santa Cruz in 506–680 fms.; off Santa Rosa Island in 30–41 fms.); Ôtatumé, 1942: 198, pl. 16, figs. 1–12 (Morai Bed of Ishikari Oil-field, Hokkaido, Mio-Pliocene); Okutani, 1957: 28; Okutani, 1962: 23; Okutani, 1966b: 301, pl. 27, figs. 1, 3; Boss, 1968: 739, figs. 16, 17, 19, 20; Keen, 1969: N664, fig. E 138, 11a, b; Boss, 1970: 70; Oberling & Boss, 1970: 82; Kanno, 1971: 81; Habe, 1977: 237.

*Calyptogena* (*Calyptogena*) *pacifica* Dall. Bernard, 1974: 11, text figs. 1A, 2A, 3A, 4A–D (anatomy; localities off British Columbia, Canada, and northern California).

*Remarks.* This, the type-species of *Calyp-togena*, is probably the best known, most widely distributed species of the genus. Bernard (1974) studied its anatomy and showed that there are but few minor features to distinguish it from closely related species.

*Unio moraiensis* Suzuki was a nomen used for populations in the Morai Beds of Japan which have been referred to *C. pacifica* (Ôtatumé, 1942; Okutani, 1962). Certain fossil species in the Americas might well fall into the synonymy of *C. pacifica* or at least constitute a portion of its geological lineage, namely, *C. gibbera* Crickmay and *C. panamensis* Olsson. The species might even be cosmopolitan since *C. valdiviae* Thiele & Jaeckel really is hardly distinguishable except for its provenance, off West and South Africa.

*Range.* According to published reports, this species is known as a fossil from Mio-Pliocene times in the Morai Bed of Ishikari Oil-field, Hokkaido, Japan (Ôtatumé, 1942), in the Pliocene of the Oga Peninsula, Akita Prefecture, Japan, as well as in Los Angeles, California (Grant & Gale, 1931). Living samples are known from Clarence Strait, Alaska to off southern California in 55–1244 m.

*Calyp-togena* (?*Calyp-togena*) *panamensis*  
Olsson

*Calyp-togena panamensis* Olsson, 1942: 33(185), pl. 2 (15), figs. 2, 3 (type-locality, Punta Burica [sandstone], Costa Rica and Panama; lower Pliocene and uppermost Miocene).

*Remarks.* From the internal view of the left valve (Olsson, 1942: pl. 2 (15), fig. 2), the dental configuration of *C. panamensis* suggests a relationship to *C. pacifica* and thus to the subgenus *Calyp-togena* rather than *Ectenagena*. The samples of *C. panamensis* appear to be an in situ thanatocenosis and are associated with other sometimes deeper water, offshore forms (e.g. *Solemya*, *Thyasira*).

*Range.* Fossil in lower Pliocene and uppermost Miocene of Punta Burica, Costa Rica and Panama (Pacific Coast).

*Calyp-togena* (*Calyp-togena*) *ponderosa*  
Boss

*Calyp-togena ponderosa* Boss, 1968: 737–742, figs. 9, 11–15, 18 (type-locality, M/V *Oregon I* station 1426, 29°07'N; 87°54'W, about 77 miles south of Mobile Bay, Gulf of Mexico, in 600 fathoms (1,097 m); additional

localities, *Pillsbury* station 364, 9°28.7'N; 76°34.3'W, Golfo del Darien, 63 miles NNE of Punta Caribana, Colombia, in 933–961 m. *Pillsbury* station 394, 9°28.6'N; 76°26.3'W, Golfo del Darien, 66 miles NNE of Punta Caribana, Colombia, in 421–641 m. *Pillsbury* station 391, 10°03.0'N; 76°27.0'W, Golfo del Darien, 69 miles SSW of Cartagena, Colombia in 1417–1767 m) Oberling & Boss, 1970: 81–90, 2 figs. 1 pl.; Boss, 1970: 70.

*Remarks.* As previously indicated (Boss, 1968), *C. ponderosa*, though similar to *C. pacifica*, has not only a thicker, heavier shell but a strong posterior radial ridge; additionally the dentitions differ.

*Range.* Living in the Caribbean Sea and Gulf of Mexico, in 421–1767 m.

*Calyp-togena* (*Calyp-togena*) *soyoe*  
Okutani

*Calyp-togena soyoe* Okutani, 1957: 27, pl. 1, figs. 1, 4, 5a–b (type-locality, 6 miles WSW of Jôgashima [islet], eastern part of Sagami Bay, Honshû, at 750 m muddy bottom, 35°05.1'N; 139°33.3'E); Habe, 1961: 122, pl. 55, fig. 17; Okutani, 1962: 22, pl. 2, figs. 10–11, pl. 4, fig. 14 (in 710–770 m, Sagami Bay); Habe, 1968: 179, pl. 55, fig. 17 (750 m in Sagami Bay and off Bôsô Peninsula, Honshû); Boss, 1970: 70; Bernard, 1974: 18; Habe, 1977: 237 (in 750–1000 m, Sagami Bay).

*Akebiconcha soyoe* (Okutani). Okutani, 1966a: 11, pl. 1, fig. 7 (in 1005–1020 m, Sagami Bay); Okutani, 1966b: 300, pl. 28, figs. 1–2.

*Remarks.* Okutani (1957) introduced this name for specimens between 50 and 140 mm in length taken by the R/V *Soyo-Maru* in Sagami Bay at a depth of 750 m; he remarked on its similarity to *C. pacifica*, *C. elongata*, and *C. nipponica* and also noted a relationship with *Akebiconcha kawamurai* as well but suggested that the mesial constriction of the valves was diagnostic for *C. soyoe*. In 1962, he presented a key to the species, *C. soyoe*, *C. nipponica*, *C. elongata* and *C. pacifica*, wherein one of the diagnostic features was size, now known to be highly variable. He (1966a, b) transferred *C. soyoe* to *Akebiconcha* and placed the genus in the Arcticidae (as Cyprinidae). However, *Akebiconcha* seems to be indistinguishable from *Calyp-togena* (Boss, 1968) and the genus does not show familial affinities with the Arcticidae (see *Remarks* in text on the genus *Calyp-togena*).

Were large series of *C. soyoae* and *C. nipponica* available, it is quite possible that *C. soyoae* would prove to be synonymous with *C. nipponica* (and its synonyms, *C. kawamura* and *C. k. elongata* Ozaki, see Hatai & Nisiyama, 1952).

*Range.* Living in Sagami Bay, Honshû, between 750–1020 m.

*Calyptogena (Calyptogena) valdiviae*  
(Thiele & Jaeckel)

*Vesicomya valdiviae* Thiele & Jaeckel, 1931: 229 (71), pl. 9 (4), fig. 101 (*Valdivia* stations 33 and 103).

*Calyptogena valdiviae* (Thiele & Jaeckel). Boss, 1968: 742; Boss, 1970: 69–70, figs. 3, 4, 22, 23 (type-locality designated, *Valdivia* station 33, 24°35.3'N; 17°4.7'W, about 140 miles (23 km) off Morro Garnet, Rio de Oro, West Africa, in 2500 m; additional locality, *Valdivia* Station 103, 35°10.5'S; 23°2'E, about 72 miles (120 km) south of Knysna, Republic of South Africa, just off Agulhas Bank, in 500 m).

*Remarks.* As noted in Boss (1968: 742; 1970: 70), *C. valdiviae* closely resembles *C. pacifica* and may be separable on such features as minor differences in outline (*C. valdiviae* has a more convex ventral margin) and sculpture (*C. valdiviae* has less weakly expressed growth lines and concentric lirations).

*Range.* Living (?). From off west Africa to off south Africa in 500–2500 m.

#### ACKNOWLEDGEMENTS

For receipt of specimens collected off the Galapagos during ALVIN Cruise 90 in 1977 we are grateful to J. Corliss, Chief Scientist, and for specimens collected in the same area during ALVIN Cruise 102, leg 9, in 1979, we thank C. Berg and F. Grassle, Chief Scientist; R. Ballard, Chief Scientist on leg 10 of the 1979 cruise kindly supplied pictures and data on populations seen around vents on the East Pacific Rise off Mexico during ALVIN dives 915 and 917. We are grateful to J. Rosewater for the loan of type specimens and collections from the National Museum of Natural History (USNM). The 1977 expedition was supported by a National Science Foundation grant to Oregon State University. The 1979 expedition was supported by NSF Grant No. OCE-08855 to Harvard University.

Special thanks are due W. Woodring and D. Wilson for help in finding specimens of fossil *Calyptogena* in the USNM and to C. M. Yonge and an anonymous reader who criticized the text.

This article is contribution Number 2 of the Galapagos Rift Biology Expedition.

#### LITERATURE CITED

- ALLEN, J. A., 1958, On the basic form and adaptations to habitat in the Lucinacea (Eulamellibranchia). *Philosophical Transactions of the Royal Society of London*, ser. B, 241: 421–484.
- ALLEN, J. A., 1968, The functional morphology of *Crassinella mactracea* (Linsley) (Bivalvia: Astartacea). *Proceedings of the Malacological Society of London*, 38: 27–40.
- AOKI, S., 1954, Mollusca from the Miocene Kabeya Formation. Jôban coal-field, Fukushima Prefecture, Japan. *Science Reports of the Tokyo Kyoiku Daigaku* (formerly Tokyo Bunrika Daigaku), *Tokyo University of Education, Geological and Mineralogical Institute, Sec. C.*, 3(17): 23–41, 2 pl.
- BALLARD, R. D. & GRASSLE, J. F., 1979, Return to oases of the deep. *National Geographic*, 156(5): 689–705.
- BERNARD, F. R., 1974, The genus *Calyptogena* in British Columbia with a description of a new species (Bivalvia, Vesicomidae). *Venus*, 33: 11–22.
- BOLTZMANN, H., 1906, Beiträge zur Kenntnis der Perikardialdrüse der Lamellibranchiaten. *Arbeiten aus dem Zoologischen Institut der Universität Wien*, 16: 313–324, 1 pl.
- BOSS, K. J., 1967, A new species of *Vesicomya* from the Caribbean Sea (Mollusca: Bivalvia: Vesicomidae). *Breviora*, No. 266, 6 p.
- BOSS, K. J., 1968, Biological Investigations of the Deep Sea, 40. New species of Vesicomidae from the Gulf of Darien, Caribbean Sea (Bivalvia; Mollusca). *Bulletin of Marine Science*, 18: 731–748.
- BOSS, K. J., 1969a, Systematics of the Vesicomidae (Mollusca: Bivalvia). *Malacologia*, 9: 254–255.
- BOSS, K. J., 1969b, Nomenclatorial note: Arcticidae versus Cyprinidae (Mollusca; Bivalvia). *Nautilus*, 83: 61–64.
- BOSS, K. J., 1970, Redescription of the *Valdivia Vesicomya* of Thiele and Jaeckel. *Mitteilungen aus dem Zoologischen Museum in Berlin*, 46: 67–84.
- BOSS, K. J. & KENK, V. C., 1964, Anatomy and relationships of *Temnoconcha brasiliensis* Dall. *Occasional Papers on Mollusks, Harvard University*, 2: 325–343, pl. 55–60.
- BULLOCK, T. & HORRIDGE, A., 1965, *The structure and function of the nervous system in invertebrates*. Freeman, San Francisco, 2 vols., xx + 1719 p.
- CLAUSEN, C., 1958, On the anatomy and history



- of the Eulamellibranch *Kelliella miliaris* (Philippi) with observations on the ciliary mechanisms in the mantle cavity. *Nytt Magasin for Zoologi*, 6: 144–175, 5 pl.
- CORLISS, J. B. & BALLARD, R. D., 1977, Oases of life in the cold abyss. *National Geographic*, 152(4): 441–453.
- CORLISS, J. B. et al., 1979, Submarine thermal springs on the Galápagos Rift. *Science*, 203 (4385): 1073–1083.
- COSSMANN, M., 1920, [Review.] *Revue Critique de Paléozoologie et de Paléophytologie*, 24: 29.
- COX, L. R., 1969, Superfamily Solemyacea H. Adams & A. Adams, in Moore, R. C., ed., *Treatise on Invertebrate Paleontology*, Part N, vol. 1, Mollusca 6, Bivalvia: 241–243.
- CRICKMAY, C. H., 1929, On a new pelecypod, *Calyptogena gibbera*. *Canadian Field-Naturalist*, 43: 93, 1 fig.
- DALL, W. H., 1886, Reports on the results of dredging, under the supervision of Alexander Agassiz, in the Gulf of Mexico (1877–78) and in the Caribbean Sea (1879–80), by the U.S. Coast Survey steamer "Blake," Lieut.-Commander C. D. Sigsbee, U.S.N. and Commander J. R. Bartlett, U.S.N. commanding. XXIX. Report on the Mollusca, Part 1, Brachiopoda and Pelecypoda. *Bulletin of the Museum of Comparative Zoology*, 12: 171–318, pl. 1–9.
- DALL, W. H., 1891, On some new or interesting West American shells obtained from the dredgings of the U.S. Fish Commission steamer "Albatross" in 1888, and from other sources. *Proceedings of the United States National Museum*, 14(849): 173–191, pl. 5–7.
- DALL, W. H., 1895a, Contributions to the Tertiary fauna of Florida, with especial reference to the Miocene silex-beds of Tampa and the Pliocene beds of the Caloosahatchie River. Tertiary mollusks of Florida. Part III. A new classification of the Pelecypoda. *Transactions of the Wagner Free Institute of Science of Philadelphia*, 3: 485–570.
- DALL, W. H., 1895b, Scientific results of explorations by the U.S. Fish Commission steamer "Albatross." No. XXXIV. Report on Mollusca and Brachiopoda dredged in deep water, chiefly near the Hawaiian Islands, with illustrations of hitherto unfigured species from northwest America. *Proceedings of the United States National Museum*, 17: 675–733, pl. 23–32.
- DALL, W. H., 1903a, Synopsis of the Carditacea and of the American species. *Proceedings of the Academy of Natural Sciences of Philadelphia*, 54: 696–716.
- DALL, W. H., 1903b, Contributions of the Tertiary fauna of Florida with especial reference to the silex-beds of Tampa and the Pliocene beds of the Caloosahatchie River, including in many cases a complete revision of the generic groups treated of and their American Tertiary species. Part VI. Concluding the work. *Transactions of the Wagner Free Institute of Science of Philadelphia*, 3:1219–1654. pl. 48–60.
- DALL, W. H., 1908, The Mollusca and the Brachiopoda. *Bulletin of the Museum of Comparative Zoology*, 43: 415–419, pl. 6, 16, 17, 18.
- DALL, W. H., 1916, Diagnoses of new species of marine bivalve mollusks from the northwest coast of America in the United States National Museum. *Proceedings of the United States National Museum*, 52(2183): 393–417.
- DALL, W. H., 1921, Summary of the marine shell-bearing mollusks of the northwest coast of America, from San Diego, California, to the Polar Sea, mostly contained in the collection of the United States National Museum, with illustrations of hitherto unfigured species. *Bulletin of the United States National Museum*, 112: 1–217, pl. 1–22.
- DALL, W. H. & SIMPSON, C. T., 1901, The Mollusca of Porto Rico. *U.S. Fisheries Commission Bulletin*, 20: 351–524, pl. 53–58.
- DREDGING AND HYDROGRAPHIC RECORDS of the U.S. Fisheries Steamer *Albatross* for 1904 and 1905, 1906, *Bureau of Fisheries Document* no. 604, Washington: 1–80.
- DUVERNOY, M., 1853, Mémoires sur le système nerveux des Mollusques Acephales. *Mémoires Académie des Sciences, Paris*, 24: 3–312.
- GRANT, U. S. & GALE, H. R., 1931, Catalogue of the marine Pliocene and Pleistocene Mollusca of California and adjacent regions. *Memoirs of the San Diego Society of Natural History*, 1: 1036 p., 32 pl.
- GRASSLE, J. R., BERG, C. J., CHILDRESS, J. J., GRASSLE, J. P., HESSLER, R. R., JANNASCH, H. J., KARL, D. M., LUTZ, R. A., MICKEL, T. J., RHOADS, D. C., SANDERS, H. L., SMITH, K. L., SOMERO, G. N., TURNER, R. D., TUTTLE, J. H., WALSH, P. J. & WILLIAMS, A. J., 1979, Galápagos '79: initial findings of a deep-sea biological quest. *Oceanus*, 22(2): 2–10.
- HABE, T., 1951–1953, Lyonsiidae, Poromyidae, Arcticiidae and Gaimardiidae in Japan. *Illustrated catalogue of Japanese shells*, 21: 153–160, pl. 22.
- HABE, T., 1961, *Coloured illustrations of the shells of Japan*. Hoikusha, Osaka, vol. 2: 133 p.
- HABE, T., 1968, *Shells of the Western Pacific in color*. Vol. II. Revised edition. Hoikusha, Osaka, 233 p.
- HABE, T., 1977, *Systematics of Mollusca in Japan. Bivalvia and Scaphopoda*. Tokyo, 372 p.
- HANZAWA, S., ASANO, K. & TAKAI, F., 1961, Catalogue of type-specimens of fossils in Japan. *Paleontological Society of Japan, 25th Anniversary Volume*, 422 p.
- HARRY, H. W., 1966, Studies on bivalve molluscs of the genus *Crassinella* in the Northwestern Gulf of Mexico: anatomy, ecology and systematics. *Publication of the Institute of Marine Science, University of Texas*, 11: 65–89.
- HATAI, K. & NISIYAMA, S., 1952, Check list of Japanese Tertiary marine Mollusca. *Science Reports of the Tôhoku University, Sendai, Japan*, ser. 2, special vol. 3: 464 p.
- ITOIGAWA, J., 1958, Molluscan fossils from the Niitsu, Higashiyama and Takezawa oil-fields,

- Niigata Prefecture, Japan. *Memoirs of the College of Science, University of Kyoto*, ser. B 24(4): 249–263, 2 pl.
- KAMADA, Y., 1962, Tertiary marine Mollusca from the Jôban coal-field, Japan. *Paleontological Society of Japan, Special Paper*, 8: 187 p. 21 pl.
- KANEHARA, K., 1937, Miocene shells from the Jôban coal-field. *Bulletin of the Imperial Geological Survey of Japan*, 27(1): 1–21, 5 pl.
- KANNO, S., 1967, Mollusks of the Itsukaichi Basin. *Shibaba Memorial Volume*: 401–402, pl. 1, figs. 9–11, 15.
- KANNO, S., 1971, Tertiary molluscan fauna from the Yakataga District and adjacent areas of southern Alaska. *Palaeontological Society of Japan, Special Paper*, 16, 154 p., 18 pl.
- KANNO, S. & OGAWA, H., 1964, Molluscan fauna from the Momijiyama and Takinoue districts, Hokkaido, Japan. *Science Reports of the Tokyo Kyoiku Daigaku* [Tokyo University of Education], Section C, Geology, Mineralogy and Geography, 8(81): 269–294, 4 pl.
- KEEN, A. M., 1969, Family Vesicomidae Dall, 1908 In MOORE, R. C., ed., *Treatise on Invertebrate Paleontology*, Part N, vol. 2, Mollusca 6, Bivalvia: 663–664.
- KEEN, A. M., 1977a, A deep-water paradox. *Annual Reports of the Western Society of Malacologists*, 10: 10.
- KEEN, A. M., 1977b, New sea-floor oasis. *Veliger*, 20: 179–180.
- KURODA, T., 1931, Fossil Mollusca In HOMMA, F. *Geology of central part of Shinano Province (Shinano Chubu Chishitsu-Shi)*. Part 4, 90 p., 1–13.
- KURODA, T., 1943, *Akebiconcha*, a new pelecypod genus. *Venus, Japanese Journal of Malacology*, 13: 14–18.
- LAMMENS, J. J., 1969, The morphology of the central nervous system of *Macoma balthica* (L.). *Archives Néerlandaises de Zoologie*, 19: 105–127.
- LAMY, E., 1920, Révision des Cypricardiacea et des Isocardiacea vivants du Muséum d'Histoire Naturelle de Paris. *Journal de Conchyliologie*, 64: 259–307.
- LAMY, E., 1922, Révision des Carditacea vivants du Muséum National d'Histoire Naturelle de Paris. *Journal de Conchyliologie*, 66: 218–276, 12 figs., pl. 8; 289–368.
- LONSDALE, P., 1977, Clustering of suspension-feeding macrobenthos near abyssal hydrothermal vents at oceanic spreading centers. *Deep-Sea Research*, 24: 857–863.
- MAKIYAMA, J., 1958, Matajiro Yokoyama's Tertiary fossils from various localities in Japan. *Paleontological Society of Japan, Special Paper* 4, 6 p., pl. 25–57.
- OBERLING, J. J. & BOSS, K. J., 1970, Observations on the shell structure of *Calyptogena* (Vesicomidae; Bivalvia; Mollusca). *Revue Suisse de Zoologie*, 77: 81–90, 1 pl.
- ODHNER, N. H., 1912, Morphologische und phylogenetische Untersuchungen über die Nephridien der Lamellibranchien. *Zeitschrift für wissenschaftlichen Zoologie*, 100: 287–391.
- ODHNER, N. H., 1960, Mollusca. *Report for the Swedish Deep-sea Expedition*, 2 (Zoology 22): 365–400, 2 pl.
- OINOMIKADO, T. & KANEHARA, K., 1938, A new species of *Calyptogena* from the Higashiyama oilfield, Niigata-ken, *Japanese Journal of the Geological Society of Japan*, 45(539): 677–678, pl. 21.
- OKUTANI, T., 1957, Two new species of bivalves from the deep water in Sagami Bay collected by the R. V. *Soyo-Maru*. *Bulletin of the Tokai Regional Fisheries Research Laboratory*, 17: 27–30, pl. 1.
- OKUTANI, T., 1962, Report on the archibenthal and abyssal lamellibranchiate Mollusca mainly collected from Sagami Bay and adjacent waters by the R.V. *Soyo-Maru* during the years 1955–1960. *Bulletin of the Tokai Fisheries Research Laboratories*, no. 32: 1–40, 5 pl.
- OKUTANI, T., 1966a, Archibenthal and abyssal Mollusca collected by the R.V. *Soyo-Maru* from Japanese waters during 1964. *Bulletin of the Tokai Regional Fisheries Research Laboratory*, 46, 32 p., 2 pl.
- OKUTANI, T., 1966b, Identity of *Calyptogena* and *Akebiconcha* (Bivalvia, Cyprinidae). *Venus*, 24: 297–303, pl. 27–28 (English summary).
- OLDROYD, I. S., 1924, Marine shells of the Puget Sound and vicinity. *Publications of the Puget Sound Geological Station, University of Washington, Seattle*, 4: 1–272, 49 pl.
- OLSSON, A. A., 1931, Contributions to the Tertiary Paleontology of Northern Peru: Part 4. The Peruvian Oligocene. *Bulletins of American Paleontology*, 17(63): 97–264 (1–168), pl. 13–33 (1–21).
- OLSSON, A. A., 1942, Tertiary and Quaternary fossils from the Burica Peninsula of Panama and Costa Rica. *Bulletins of American Paleontology*, 27(106): 1–82, pl. i–xii.
- ÔTATUME, K., 1942, On the occurrence of fossil *Calyptogena* from the Isikari Oil-field, Hokkaido. *Journal of the Geological Society of Japan*, 49(590): 435–437, pl. 16.
- OTUKA, Y., 1937, Occurrence of *Calyptogena pacifica* Dall from Wakimoto on Oga Peninsula. *Journal of the Geological Society of Japan*, 44(522): 231, 1 fig.
- OWEN, G., 1953, On the biology of *Glossus humanus* (L.) (*Isocardia cor* Lam.). *Journal of the Marine Biological Association of the United Kingdom*, 32: 85–106.
- OZAKI, H., 1958, Stratigraphical and paleontological studies on the Neogene and Pleistocene formation of the Tyoshi District. *Bulletin of the National Science Museum of Tokyo*, 42: 1–182, pl. 1–24.
- PELSENEER, P., 1891, Contributions à l'étude des

- lamellibranches. *Archives de Biologie, Paris*, 11: 147–312, pl. 6–23.
- PELSENEER, P., 1911, Lamellibranches de l'expédition du Siboga. Partie anatomique. *Siboga Expeditie Leiden, Monographie* 53a, 125 p., 26 pl.
- PURCHON, R. D., 1939, Reduction of the ctenidia in the Lamellibranchia. *Nature*, 144: 206.
- RIDEWOOD, W. G., 1903, On the structure of the gills of the Lamellibranchia. *Philosophical Transactions of the Royal Society of London*, ser. B, 195: 147–284.
- SALEUDDIN, A. S. M., 1964, Observations on the habit and functional anatomy of *Cyprina islandica* (L.). *Proceedings of the Malacological Society of London*, 36: 149–162.
- SALEUDDIN, A. S. M., 1965, The mode of life and functional anatomy of *Astarte* spp. (Eulamellibranchia). *Proceedings of the Malacological Society of London*, 36: 229–257.
- SEMPER, K., 1880, *Die natürlichen Existenzbedingungen der Thiere*. Bd. 1.
- SHIKAMA, T., 1962, On some noteworthy shells from off Choshi, Chiba Prefecture. *Science Reports of the Yokohama National University*, Sec. II, 8: 29–56, pl. 1–3.
- SMITH, E. A., 1885, Report on the Lamellibranchiata collected by H.M.S. *Challenger*. Report of the Scientific Results. Voyage of H.M.S. *Challenger*. Zoology, 13: 1–341, 25 pl.
- STUARDO, J. R., 1968, *On the phylogeny, taxonomy and distribution of the Limidae (Mollusca: Bivalvia)*. Ph.D. thesis, Harvard University, i–ii, 1–327, 27 pl., 24 maps.
- SUZUKI, K., 1941, Three new species of non-marine shells from the Tertiary formation of Hokkaido and Karahuto. *Japanese Journal of Geology and Geography*, 18: 53–58, pl. 4.
- TAKEDA, H., 1953, The Poronai Formation (Oligocene Tertiary) of Hokkaido and South Sakhalin and its fossil fauna. *Studies on Coal Geology*. No. 3. Geological Section. The Hokkaido Association of Coal Mining Technologists, Sapporo, Japan, p. 85.
- TANAKA, K. [Y?], 1959, Molluscan fossils from Central Shinano. Nagano Prefecture Japan (Part 1). Fossils from Akanuda limestone. *Journal Shinshu University*, 8: 115–127, pl. 1–3.
- TAYLOR, J. D., KENNEDY, W. J. & HALL, A., 1973, The shell structure and mineralogy of the Bivalvia: II: Lucinacea-Clavagellacea. Conclusions. *Bulletin of the British Museum of Natural History, Zoology*, 22: 253–294, 15 pl., 33 figs., 22 tables.
- THIELE, J., 1886, Die Mundlappen der Lamellibranchiaten. Inaugural-dissertation. Leipzig. Wilhelm Engelmann. 34 p., 2 pl. *Zeitschrift für wissenschaftliche Zoologie*, 45: 239–272.
- THIELE, J., 1934–1935, *Handbuch der systematischen Weichtierkunde*. Jena, Fischer, 2: 779–1022.
- THIELE, J. & JAECKEL, S., 1931, Muscheln der deutschen Tiefsee-Expedition. *Wissenschaftliche Ergebnisse deutschen Tiefsee Expedition*, 21: 161–268 (1–100), pl. 6–10 (1–5).
- TUREKIAN, K. K., COCHRAN, J. K. & NOZAKI, Y., 1979, Growth rate of a clam from the Galapagos Rise hot spring field using natural radionuclide ratios. *Nature*, 280: 385–387.
- TURNER, R. D., 1966, *A survey and illustrated catalogue of the Teredinidae*. Museum of Comparative Zoology, Cambridge, 265 p., 64 pl.
- WALLER, T. R., 1978, Morphology, morphoclines and a new classification of the Pteriomorphia (Mollusca: Bivalvia). *Philosophical Transactions of the Royal Society of London*, ser. B, 284: 345–365, 2 figs.
- WHITE, K. M., 1942, The pericardial cavity and the pericardial gland of the Lamellibranchia. *Proceedings of the Malacological Society of London*, 25: 37–88.
- WINKLE, K. VAN, 1919, Remarks on some new species from Trinidad. *Bulletins of American Paleontology*, 8(33): 19–27, pl. 3.
- WINTERER, E. L. & DURHAM, D. L., 1962, Geology of southeastern Ventura Basin, Los Angeles County, California. *United States Geological Survey Professional Paper* 334-H: 275–366, 6 pl.
- WOODRING, W. P., 1938, Lower Pliocene mollusks and echinoids from the Los Angeles Basin, California. *United States Department of the Interior, Geological Survey Professional Paper* 190: 67 p., 9 pl.
- WOODRING, W. P., BRAMLETTE, M. N. & KEW, W. S. W., 1946, Geology and paleontology of Palos Verdes Hills, California. *United States Geological Survey Professional Paper* 207: 145 p., 57 pl.
- YOKOYAMA, M., 1925, Tertiary Mollusca from Shinano and Echigo. *Journal of the Faculty of Science of the Imperial University of Tokyo*, Sec. II, 1(1): 1–22, pl. 1–7.
- YONGE, C. M., 1957, Mantle fusion in the Lamellibranchia. *Pubblicazioni della Stazione Zoologica di Napoli*, 29: 151–171.
- YONGE, C. M., 1962, On the primitive significance of the byssus in the Bivalvia and its effects in evolution. *Journal of the Marine Biological Association of the United Kingdom*, 42: 113–125.
- YONGE, C. M., 1969, Functional morphology and evolution within the Carditacea. *Proceedings of the Malacological Society of London*, 38: 493–527.
- YONGE, C. M., 1971, On functional morphology and adaptive radiation in the bivalve superfamily Saxicavacea (*Hiatella* (= *Saxicava*), *Saxicavella*, *Panomya*, *Panope*, *Cyrtodaria*). *Malacologia*, 11: 1–44.
- YONGE, C. M., 1978a, Significance of the ligament in the classification of the Bivalvia. *Proceedings of the Royal Society of London*, ser. B, 202: 231–248.
- YONGE, C. M., 1978b, On the Dimyidae (Mollusca:

- Bivalvia) with special reference to *Dimya corrugata* Hedley and *Basiliomya goreau* Bayer. *Journal of Molluscan Studies*, 44: 357-375.
- YONGE, C. M., GOREAU, T. F. & GOREAU, N. I., 1972, On the mode of boring in *Fungiacava eilatensis* (Bivalvia: Mytilidae). *Journal of the Zoological Society of London*, 166: 55-60, 2 pl.
- ZATSEPIN, V. I. & FILATOVA, Z. A., 1961, The bivalve mollusc *Cyprina islandica* (L.), its geographic distribution and role in the communities of benthic fauna. *Transactions of the Institute of Oceanology, Academy of Sciences, USSR*, 46: 201-216.







## INSTRUCTIONS FOR AUTHORS

MALACOLOGIA publishes original studies on the Mollusca that are of international interest and are of high scholarly standards. Both descriptive and experimental research results are acceptable provided they are primarily or exclusively concerned with the phylum. Contributions include long monographs as well as moderately short research papers. Brief papers are not acceptable. MALACOLOGIA provides a forum for such different aspects of malacology as anatomy, comparative physiology, ecology, medical malacology, paleontology and systematics. Papers of only biochemical or physiological interest should be submitted elsewhere. Review articles are more appropriately submitted to *Malacological Review* (P.O. Box 801, Whitmore Lake, Michigan 48189, U.S.A.). All manuscripts submitted are reviewed by at least 2 malacologists. Articles are accepted with the firm understanding that they have not been submitted or published elsewhere in whole or in part.

**Manuscripts** may be in English, French, German or Spanish, and should follow MALACOLOGIA style. They must contain a concise but informative Abstract summarizing not only the content but the results. Papers in languages other than English should include a translation of the Abstract into English. Authors desiring their abstracts translated into other languages must provide these. Care should be taken to include all necessary foreign accents. Manuscripts must be typed on one side of good quality white paper, double-spaced throughout, with ample margins, and are to be submitted in triplicate. Illustrations are likewise to be in triplicate (the 2 copies may be photocopies, etc.). Tables, figure captions and all footnotes are to be grouped (in this order) at the end of a manuscript, and all Ms pages (including the Abstract) are to be numbered sequentially. Avoid internal page references (which have to be added in page proof). Make the hierarchy of headings within the text simple and consistent. Suggest an abbreviated running title to be used at the top of each right hand page.

Contributors in English are asked to use the *Council of Biology Editors (CBE) Style Manual* (Ed. 3, 1972), obtainable for \$6.00 from the American Institute of Biological Sciences,

1401 Wilson Boulevard, Arlington, Virginia 22209, U.S.A. MALACOLOGIA follows most of the recommendations in this *Manual*. In particular, simplified particles such as the following are used: numbers above ten should not be written out except at the beginning of a sentence; percentages following a number are expressed as %, and abbreviations of measures (after a number): mm, ml, kg, etc. have no period (full stop), nor an "s" in the plural. Note that the international symbol for micron is now  $\mu\text{m}$ , not  $\mu$ .

**Illustrations** must be carefully prepared and so planned that they can be printed in 1 column or the full width of a page of the journal. The maximum size of a printed figure is  $13.5 \times 20.0$  cm (preferably not as high as this so that the caption does not have to be on the opposite page). Drawings and lettering must be in dark black on white, blue tracing, or blue-lined paper. Lines and dots should be thick enough to allow reduction by  $\frac{1}{2}$  or  $\frac{1}{3}$ . This should be taken into consideration also in relation to the lettering. Letters and numbers must not be less than 2 mm in height, preferably larger, after reduction. Several drawings or photographs may be grouped together to fit a page, but drawings are not to be grouped with photographs. Photographs are to be glossy and high contrast. All illustrations are to be numbered sequentially as figures (not grouped as plates), and are to be arranged as closely as possible to the order in which they are first cited in the text (Each figure must be cited in the text.) All original illustrations should be mounted, numbered, labeled or lettered and ready for the engraver. Scale lines are required for all figures and should be convenient lengths (e.g., "200  $\mu\text{m}$ ," not "163  $\mu\text{m}$ "). Magnifications in captions are not acceptable, and neither are photographic reductions of line drawings.

**Captions** should summarize what is shown in an illustration, and should not duplicate additional information given in the text. Each lettered abbreviation labeling an individual feature in a figure must either be explained in each caption (listed alphabetically), or be grouped in one alphabetic sequence in a section near the beginning of the text (use the latter method if many abbreviations are repeated on different figures).

**Tables** are to be used sparingly, and should be planned to fit 1 or 2 columns on 1



page. Each table must be submitted double-spaced throughout on a separate manuscript page. Do not use vertical lines.

All **References** cited in the text must be listed (bibliographies including uncited items are unacceptable). Each reference should be cited accurately (the Editors will spot check for accuracy) and should be in the style used in recent issues of MALACOLOGIA—except that beginning with Vol. 16 journal titles will be cited complete and unabbreviated. For all manuscripts submitted henceforth, disregard the abbreviations in MALACOLOGIA, 1972, 11(2): 415–426. The journal uses the ampersand (&) for “and”; “et al.” may be used in the text, but not in the References. In addition to the volume number, complete page numbers of articles and books must be cited. If plates or maps, etc., are not included in the pagination they too must be cited. For books, the publisher and city are required. In systematic papers, synonymies should not give complete citations but should relate by author, date and page to the References.

**Voucher specimens.** In systematic papers, all new type-specimens must be deposited in museums where they may be consulted by other scientists. Beginning with Vol. 16 and when appropriate, MALACOLOGIA will also require that voucher specimens from other kinds of research be deposited in museums.

**Reprints.** When they order 50 or more reprints, authors will receive 25 additional reprints gratis; additional copies may be ordered at the time proof is returned to the Editorial Office. Later orders cannot be considered.

#### PAGE COSTS

MALACOLOGIA requests authors with grant support to help pay publication costs. MALACOLOGIA requires subsidization for extra long papers.

#### SUBSCRIPTION COSTS - VOL.21

Changes in cost of printing necessitate a personal subscription of \$17.00 and an institutional subscription of \$27.00

## CONTENTS

F. G. THOMPSON

- Proserpinoid land snails and their relationships within the Archaeogastropoda ..... 1

N. COLEMAN and W. CUFF

- The abundance, distribution and diversity of the molluscs of Western Port, Victoria, Australia ..... 35

S. M. CHAMBERS

- Genetic divergence between populations of *Goniobasis* (Pleuroceridae) occupying different drainage systems ..... 63

R. T. DILLON, Jr. and G. M. DAVIS

- The *Goniobasis* of southern Virginia and northwestern North Carolina: genetic and shell morphometric relationships ..... 83

L. G. WILLIAMS

- Development and feeding of larvae of the nudibranch gastropods *Hermisenda crassicornis* and *Aeolidia papillosa* ..... 99

R. S. HOUBRICK

- Observations on the anatomy and life history of *Modulus modulus* (Prosobranchia: Modulidae) ..... 117

C. M. YONGE

- On *Patro australis* with comparisons of structure throughout the Anomiidae (Bivalvia) ..... 143

R. M. LINSLEY and M. JAVIDPOUR

- Episodic growth in Gastropoda ..... 153

K. J. BOSS and R. D. TURNER

- The giant white clam from the Galapagos Rift, *Calyptogena magnifica* species novum ..... 161

C. J. BERG and R. D. TURNER

- Appendix 1 ..... 183

K. J. BOSS

- Appendix 2 ..... 185

MAL  
447

VOL. 20 NO. 2

MUS. COMP. ZOOLOG.  
LIBRARY

1981

JUN 19 1981

HARVARD  
UNIVERSITY

---

# MALACOLOGIA

---

International Journal of Malacology

Revista Internacional de Malacologia

Journal International de Malacologie

Международный Журнал Малакологии

Internationale Malakologische Zeitschrift

# MALACOLOGIA

*Editors-in-Chief:*

GEORGE M. DAVIS

ROBERT ROBERTSON

*Editorial and Subscription Offices:*

Department of Malacology  
The Academy of Natural Sciences of Philadelphia  
Nineteenth Street and the Parkway  
Philadelphia, Pennsylvania 19103, U.S.A.

*Associate Editors:*

JOHN B. BURCH  
University of Michigan, Ann Arbor

ANNE GISMANN  
Maadi, A. R. Egypt

*Editorial Assistants:*

MARY DUNN  
GRETCHEN R. EICHHOLTZ

MALACOLOGIA is published by the INSTITUTE OF MALACOLOGY (2415 South Circle Drive, Ann Arbor, Michigan 48103, U.S.A.), the Sponsor Members of which (also serving as editors) are:

J FRANCES ALLEN, *Emerita*  
Environmental Protection Agency  
Washington, D.C.

CHRISTOPHER J. BAYNE, *President-Elect*  
Oregon State University, Corvallis

ELMER G. BERRY, *Emeritus*  
Germantown, Maryland

KENNETH J. BOSS  
Museum of Comparative Zoölogy  
Cambridge, Massachusetts

JOHN B. BURCH

MELBOURNE R. CARRIKER  
University of Delaware, Lewes

GEORGE M. DAVIS, *Executive  
Secretary-Treasurer*

ROBERT ROBERTSON

CLYDE F. E. ROPER, *President*  
Smithsonian Institution  
Washington, D.C.

W. D. RUSSELL-HUNTER  
Syracuse University, New York

NORMAN F. SOHL  
United States Geological Survey  
Washington, D.C.

RUTH D. TURNER, *Alternate*  
Museum of Comparative Zoölogy  
Cambridge, Massachusetts

SHI-KUEI WU, *Vice-President*  
University of Colorado Museum, Boulder

Institute meetings are held the first Friday in December each year at a convenient place. For information, address the President.

## EDITORIAL BOARD

- J. A. ALLEN  
*Marine Biological Station,  
Millport, United Kingdom*
- E. E. BINDER  
*Muséum d'Histoire Naturelle  
Genève, Switzerland*
- A. H. CLARKE, Jr.  
*National Museum of Natural History  
Washington, D.C., U.S.A.*
- E. S. DEMIAN  
*Ain Shams University  
Cairo, A. R. Egypt*
- C. J. DUNCAN  
*University of Liverpool  
United Kingdom*
- Z. A. FILATOVA  
*Institute of Oceanology  
Moscow, U.S.S.R.*
- E. FISCHER-PIETTE  
*Muséum National d'Histoire Naturelle  
Paris, France*
- V. FRETTER  
*University of Reading  
United Kingdom*
- E. GITTENBERGER  
*Rijksmuseum van Natuurlijke Historie  
Leiden, Netherlands*
- A. N. GOLIKOV  
*Zoological Institute  
Leningrad, U.S.S.R.*
- A. V. GROSSU  
*Universitatea Bucuresti  
Romania*
- T. HABE  
*National Science Museum  
Tokyo, Japan*
- A. D. HARRISON  
*University of Waterloo  
Ontario, Canada*
- K. HATAI  
*Tohoku University  
Sendai, Japan*
- B. HUBENDICK  
*Naturhistoriska Museet  
Göteborg, Sweden*
- A. M. KEEN  
*Stanford University  
California, U.S.A.*
- R. N. KILBURN  
*Natal Museum  
Pietermaritzburg, South Africa*
- M. A. KLAPPENBACH  
*Museo Nacional de Historia Natural  
Montevideo, Uruguay*
- J. KNUDSEN  
*Zoologisk Institut & Museum  
København, Denmark*
- A. J. KOHN  
*University of Washington  
Seattle, U.S.A.*
- Y. KONDO  
*Bernice P. Bishop Museum  
Honolulu, Hawaii, U.S.A.*
- C. M. LALLI  
*McGill University  
Montreal, Canada*
- J. LEVER  
*Amsterdam, Netherlands*
- A. LUCAS  
*Faculté des Sciences  
Brest, France*
- N. MACAROVICI  
*Universitatea "Al. I. Cuza"  
Iasi, Romania*
- C. MEIER-BROOK  
*Tropenmedizinisches Institut  
Tübingen, Germany (Federal Republic)*
- H. K. MIENIS  
*Hebrew University of Jerusalem  
Israel*
- J. E. MORTON  
*The University  
Auckland, New Zealand*
- R. NATARAJAN  
*Marine Biological Station  
Porto Novo, India*
- J. ØKLAND  
*University of Oslo  
Norway*

T. OKUTANI  
*National Science Museum  
Tokyo, Japan*

W. L. PARAENSE  
*Universidade de Brasilia  
Brazil*

J. J. PARODIZ  
*Carnegie Museum  
Pittsburgh, U.S.A.*

C. M. PATTERSON  
*University of Michigan  
Ann Arbor, U.S.A.*

W. F. PONDER  
*Australian Museum  
Sydney*

A. W. B. POWELL  
*Auckland Institute & Museum  
New Zealand*

R. D. PURCHON  
*Chelsea College of Science & Technology  
London, United Kingdom*

O. RAVERA  
*Euratom  
Ispra, Italy*

N. W. RUNHAM  
*University College of North Wales  
Bangor, United Kingdom*

S. G. SEGERSTRÅLE  
*Institute of Marine Research  
Helsinki, Finland*

G. A. SOLEM  
*Field Museum of Natural History  
Chicago, U.S.A.*

F. STARMÜHLNER  
*Zoologisches Institut der Universität  
Wien, Austria*

Y. I. STAROBOGATOV  
*Zoological Institute  
Leningrad, U.S.S.R.*

W. STREIFF  
*Université de Caen  
France*

J. STUARDO  
*Universidad de Chile,  
Valparaiso*

T. E. THOMPSON  
*University of Bristol  
United Kingdom*

F. TOFFOLETTO  
*Società Malacologica Italiana  
Milano*

W. S. S. VAN BENTHEM JUTTING  
*Domburg, Netherlands*

J. A. VAN EEDEN  
*Potchefstroom University  
South Africa*

J.-J. VAN MOL  
*Université Libre de Bruxelles  
Belgium*

N.H. VERDONK  
*Rijksuniversiteit  
Utrecht, Netherlands*

B. R. WILSON  
*National Museum of Victoria  
Melbourne, Australia*

C. M. YONGE  
*Edinburgh, United Kingdom*

H. ZEISSLER  
*Leipzig, Germany (Democratic Republic)*

A. ZILCH  
*Natur-Museum und Forschungs-Institut  
Senckenberg  
Frankfurt-am-Main, Germany (Federal  
Republic)*

## ETUDE DE L'EFFET DU "GROUPEMENT" DES INDIVIDUS CHEZ *THEBA PISANA* (MOLLUSQUE GASTEROPODE PULMONE STYLOMMATOPHORE)

Maria Lazaridou-Dimitriadou<sup>1</sup> et Jacques Daguzan

Laboratoire de Zoologie Générale et d'Ecophysiologie, U.E.R. des Sciences Biologiques,  
Avenue du Général Leclerc, 35042 Rennes Cedex, France

### RESUME

Des expériences sont réalisées, au laboratoire, afin de préciser l'action du "groupement des individus" de *Theba pisana* (Müller) (Gastéropode Pulmoné dunicole) nés au laboratoire, sur leur croissance, leur reproduction et leur mortalité. Plus le nombre d'individus groupés est important, plus le taux de croissance est faible et plus la mortalité est élevée. Par contre, il s'avère qu'une densité animale est nécessaire pour que cette espèce puisse se reproduire normalement.

### INTRODUCTION ET OBJET DU TRAVAIL

Nous savons depuis longtemps, qu'à certaines périodes de l'année, les escargots, surtout dunicoles, s'amassent sous forme de "grappes" plus ou moins importantes. Ces regroupements temporaires et périodiques peuvent être provoqués par certains facteurs tels que l'élévation de la température du sol ou la force du vent (Astre, 1921; Engel, 1957). De plus, à ces facteurs abiotiques peuvent s'adjoindre des facteurs d'ordre "social" (Le Masne, 1952; Bigot, 1967). Ces groupements sont considérés comme primitifs et incoordonnés, et si une inter-attraction existe, il n'y a pas de coordination ou d'organisation réelle (Le Masne, 1952). Il ne s'agit probablement pas de "simples foules" liées à des facteurs physicochimiques indépendants des individus rassemblés dont le groupement dure autant que s'exerce l'influence extérieure (Rabaud, 1927, 1929). Au sein de ces groupes, il semble exister une attraction mutuelle qui serait due à des stimuli tactiles et chimiques, et qui se manifesterait après la formation de l'agrégat d'individus, rendant ainsi ce dernier plus dense. Ce groupement a certainement un rôle de protection vis-à-vis des conditions climatiques défavorables (Allee, 1928).

Plusieurs auteurs ont déjà étudié pour les Pulmonés aquatiques (Wright, 1960; Eisenberg, 1966, 1970; Mooij-Vogelaar et col.,

1970, 1973; Chevalier et col., 1974; Thomas & Benjamin, 1974. . . .) et les Pulmonés terrestres (Wolda, 1963; Yom-Tov, 1972; Chevallier, 1974; Williamson et col., 1976; Oosterhoff, 1977. . . .) les conséquences que peut entraîner le "groupement" des individus sur leur croissance, leur productivité et leur mortalité. Enfin, Bigot (1967) étudie les rassemblements animaux de *Theba pisana* (Müller)<sup>2</sup> (Gastéropode Pulmoné) aux départements des Bouches-du-Rhône, du Gard et du Vaucluse, mais il ne s'occupe pas des effets du "groupement" sur la croissance, la productivité et la mortalité de cette espèce.

Sur les dunes de Penvins, situées sur le littoral atlantique armoricain (Morbihan, France), on remarque qu'à certaines périodes de l'année, les individus de *Theba pisana* se présentent temporairement sous forme de groupes plus ou moins denses. L'étude de la distribution spatiale de *Theba pisana* au cours de l'année présente une répartition de type "en agrégats" (indice de Taylor:  $\sigma^2 = 2.29(\bar{x})^{1.45}$ )<sup>3</sup> et  $\sigma^2 > \bar{x}$  et  $1 < b \rightarrow \infty$ . Si on considère séparément les valeurs de la variance relative ( $\lambda^2 = \sigma^2/\bar{x}$ )<sup>3</sup>, on remarque qu'elles sont plus accentuées pendant la période d'accouplement (par exemple,  $\lambda^2 = 7.5$  le 18 juillet 1977; ce jour-là le nombre maximal d'animaux qui étaient sur une grappe, était de 36) et les journées sèches et ventées pendant lesquelles les animaux se ramassent en grappe sur des plantes abritées (par ex-

<sup>1</sup>Laboratoire de Zoologie, Université de Thessaloniki, Grèce.

<sup>2</sup>Synonyme: *Euparypha pisana*.

<sup>3</sup>Où  $\sigma^2$  = la variance,  $\bar{x}$  = le moyen et  $\lambda^2$  = la variance relative.

emple,  $\lambda^2 = 11.2$  le 6 avril 1978; ce jour-là le nombre maximal d'animaux mesuré sur une grappe était de 52) (Lazaridou-Dimitriadou, 1978).

De plus, sur une zone du cordon dunaire à végétation clairsemée, le nombre moyen d'animaux par mètre carré variait de 1 à 5 et de 5 à 9 sur une autre zone à végétation plus dense, sur le même cordon et pendant la période mai 1977-mai 1978. Pendant la même période mais dans l'arrière-pays, où changeait considérablement la pédologie et où la végétation était très dense, le nombre moyen d'animaux par m<sup>2</sup> variait de 110 à 1200. Sur ce dernier biotope la répartition de *Theba pisana* était toujours de type "en aggrégats" (par exemple, le  $\lambda^2 = 18.8$  le mai 1977; à ce jour-là le nombre maximal d'animaux, qui étaient sur une grappe, était de 115). Enfin, on constate que le nombre d'oeufs pondus de *Theba pisana* dans l'arrière-pays variait de 40 à 70 et de 10 à 30 sur le cordon dunaire. Pitchford (1954) pense que le nombre d'oeufs pondus par *Theba pisana* varie de 40 à 50 et il note que Taylor compte environs 60 oeufs, mais déposés en trois moments différents.

A la suite de ces constatations il nous a paru intéressant d'examiner dans des conditions expérimentales précises si le "groupement" des individus de *Theba pisana* observé sur le terrain a une action sur la croissance et la productivité de cette espèce.

## PROTOCOLE EXPERIMENTALE

Cette étude est réalisée au laboratoire, sur des animaux marqués (à l'aide d'une pastille de plastique, numérotée et collée sur la coquille), ayant le même âge et élevées à partir de pontes ramenées des dunes de Penvins. Les escargots sont élevés ensemble et nourris avec de la laitue, pendant deux mois. Puis, on sélectionne parmi eux des individus

ayant sensiblement la même taille (même valeur du grand diamètre de la coquille).

Dans des enceintes de plexiglass<sup>4</sup> (18 × 12 × 7.5 cm) contenant du sable sur une hauteur de 3 cm, nous plaçons des animaux à des densités croissantes (progression géométriques): isolés, groupés par 2, 4 ou 8 (Tableau 1). De cette manière, si les effets du groupement des individus sont des "effets de masse" (Grassé, 1946, 1968) leur intensité augmentera d'un type de groupement à un autre. La température varie entre 12° et 22°C, selon la saison, et l'humidité relative journalière oscille entre 50 et 95% selon l'heure d'arrosage.

Les escargots sont nourris avec de la laitue, lavée à l'eau, fournie en excès et dont la quantité est proportionnelle au nombre d'individus par boîte. De plus, l'apport de calcaire se fait sous forme de maërl lavé, broyé, séché à 105°C et disposé dans deux des coins opposés des enceintes d'élevage.

Tous les 2 ou 3 jours, la nourriture est changée, les fèces retirées et chaque boîte d'élevage nettoyée, selon les normes établies par Herzberg (1965). De même, tous les 15 jours, chaque animal est pesé à l'aide d'une balance "Mettler" au 1/100 de gramme et sa coquille est mesurée (grand diamètre de la coquille (GD), et diamètre de son ouverture) à l'aide d'un pied à coulisse au 1/10 de mm. Enfin, chaque jour, on note les événements essentiels qui peuvent se manifester: accouplement, ponte, éclosion, mortalité.<sup>5</sup>

## RESULTATS

Chaque mois on teste l'homogénéité des mesures obtenues pour des "types de groupement" (1, 2, 4 ou 8) grâce à l'analyse de la variance. Les différences enregistrées entre les divers essais réalisés avec un même "type de groupement" n'étant pas significa-

TABLEAU 1. Caractéristiques des expériences réalisées dans les diverses enceintes.

Nbre. des enceintes d'élevage utilisées	Nbre. d'individus par enceinte	Espace disponible par individu (en cm <sup>3</sup> )	Nbre. d'individus par m <sup>2</sup>
3	8	202	370
5	4	405	185
5	2	810	93
5	1	1620	46

<sup>4</sup>Le couvercle des enceintes est fait d'une toile de nylon à mailles carrés de 1 mm de côté.

<sup>5</sup>Avec la collaboration technique de Mlle. Marie-Madeleine Le Piver, aide biologiste C.N.R.S.





0.05), il est alors possible de regrouper les résultats concernant chaque groupement. Dans la série relative au groupement "type 4 individus" et "type 2," nous ne tenons pas compte d'une enceinte expérimentale, dans laquelle, il y a eu apparition de microorganismes indéterminés.

*Influence du groupement des individus sur leur croissance. Evolution du grand diamètre de la coquille (GD) et du poids total (P) de l'animal pendant la durée de l'expérience*

Grâce aux nombreuses mesures effectuées, il est possible de suivre les évolutions du grand diamètre de la coquille (Tableau 2) et du poids total de chaque escargot pour chaque "type de groupement" (Tableau 2). On constate que la taille maximale est d'autant plus réduite et la vitesse avec laquelle cette taille est atteinte d'autant plus diminuée que l'effectif est plus important.

En plus, les moyennes du grand diamètre de la coquille des individus obtenus, respectivement pour le groupement "type 8" au-delà du 22 juillet 1977 et pour le groupement "type 4" au-delà du 6 août 1977 peuvent apparaître à priori comme aberrantes, mais sont tout simplement dues au fait que les individus qui vivent le plus longtemps sont aussi les plus petits et que par conséquent la moyenne devient alors beaucoup plus faible (Tableau 2). Le même phénomène s'observe en ce qui concerne l'évolution du poids total moyen des individus (Tableau 2), mais il est accentué par l'existence de la ponte (types 2, 4) ou de la mortalité constatée pour le groupement "type 8." De plus, nous constatons qu'au début du mois d'août, les individus isolés perdent du poids, phénomène probablement dû à une diminution de l'activité et de la consommation alimentaire des animaux, le

moment que ces individus pondent beaucoup plus tard.

Afin de voir s'il existe une différence significative entre les taux de croissance relative du grand diamètre de la coquille (GD) en fonction du diamètre de son ouverture (d), des individus appartenant aux divers types de groupement, on utilise la loi d'allométrie simple d'Huxley et de Teissier (1936) précisée en particulier pour les Gastéropodes Prosobranches par Daguzan (1975) et dont la formule en coordonnées logarithmiques est:  $\log GD = a (\log d) + \log b$  (où a, b: constantes).

Cette droite ainsi obtenue, ou axe majeur réduit, a une pente (a) qui représente le taux de croissance relative du GD en fonction du d. Il est possible de comparer éventuellement les pentes des droites d'allométrie obtenues en admettant que:

$difa > 3\sigma_{difa}$  : la différence entre les pentes est très significative (seuil à 99%)

$2difa < difa < 3\sigma_{difa}$  : différence significative (seuil à 95%)

$difa < 2\sigma_{difa}$  : différence non significative

(Où  $difa = |a_i - a_{ij}|$ ;  $\sigma_{difa} = \sqrt{(\sigma_{a_i})^2 + (\sigma_{a_{ij}})^2}$  et  $\sigma_{a_i}$ ,  $\sigma_{a_{ij}}$ : les écart-types des a de chaque formule).

Tout d'abord, on constate que quel que soit le type de groupement des escargots, il existe une très bonne corrélation (r) entre le GD et le d (Tableau 3); on note aussi une allométrie majorante de la croissance du grand diamètre de la coquille par rapport à celle du diamètre de l'ouverture car  $a > 1$  (Tableau 3). Enfin, il existe une différence significative entre les pentes des axes majeurs réduits des individus appartenant au "groupement type 8" et

TABLEAU 3. Principaux paramètres de la croissance relative du grand diamètre de la coquille (GD) en fonction du diamètre (d) de l'ouverture chez *Theba pisana*; (en coordonnées logarithmiques). a, b = constantes; r = coefficient de corrélation;  $\bar{d}$ ,  $\overline{GD}$  = moyens; N = effectif;  $\sigma$  = écart-type, correspondant au coefficient de sécurité 68.3%.

Paramètres	Groupement "types 8"	Groupement "types 4"	Groupement "types 2"	Animaux isolés
a $\pm \sigma_a$	1.032 $\pm$ 0.016	1.086 $\pm$ 0.016	1.090 $\pm$ 0.022	1.133 $\pm$ 0.042
logb $\pm \sigma_b$	0.208 $\pm$ 0.014	0.161 $\pm$ 0.015	0.159 $\pm$ 0.020	0.117 $\pm$ 0.040
r	0.985	0.986	0.986	0.977
$\overline{\log d} \pm \sigma_{\log d}$	0.874 $\pm$ 0.123	0.918 $\pm$ 0.114	0.940 $\pm$ 0.120	0.944 $\pm$ 0.112
$\overline{\log GD} \pm \sigma_{\log GD}$	1.109 $\pm$ 0.127	1.158 $\pm$ 0.124	1.184 $\pm$ 0.131	1.187 $\pm$ 0.127
N	134	126	68	35

TABLEAU 4. Comparaison des droites d'allométrie représentant la croissance chez *Theba pisana*. (G: groupement; difa:  $|a_i - a_{ij}|$  et  $\sigma_{difa}: \sqrt{(\sigma_{a_i})^2 + (\sigma_{a_{ij}})^2}$ )

Comparaison des pentes des droites d'allométrie	Différence entre les pentes (difa)	Ecart-type de la différence entre les pentes ( $\sigma_{difa}$ )	Signification de la différence
$G_8 - G_1$	0.101	0.045	Significative (au seuil de 95%)
$G_8 - G_2$	0.058	0.027	Significative (au seuil de 95%)
$G_8 - G_4$	0.054	0.023	Significative (au seuil de 95%)
$G_4 - G_1$	0.047	0.045	Non significative
$G_4 - G_2$	0.004	0.028	Non significative
$G_2 - G_1$	0.043	0.047	Non significative

celle des escargots des autres “types de groupement” (Tableau 4). De plus, en comparant les valeurs de  $a$  on observe que plus l'effectif est important et plus la vitesse de croissance est faible (Tableau 3).

*Etude de la variabilité de la croissance observée chez les individus appartenant au sein d'un même “type de groupement”*

Au sein d'un groupement donné, on note qu'un certain nombre d'individus présente une taille beaucoup plus petite que les autres. Ainsi, pour chaque type de groupement étudié, on calcule le “coefficient de retard de croissance” en effectuant la différence entre le grand diamètre moyen  $(\overline{GD})_1$  de la coquille des individus les plus grands appartenant à ce groupement et le grand diamètre moyen  $(\overline{GD})_2$  de la coquille des plus petits escargots rencontrés également dans ce type de groupement (Fig. 1).

De cette étude, on constate que plus le nombre d'individus groupés est important et plus le “coefficient de retard de croissance” est grand. De plus, quel que soit le type de groupement, ce “coefficient de retard de croissance” augmente en fonction de l'âge des individus, passe par un maximum, puis diminue par le fait que la croissance devient pratiquement nulle chez les adultes et que les individus en retard de croissance continuent à s'accroître.

*Influence du “groupement” des individus sur leur reproduction*

Des observations effectuées régulièrement permettent d'établir, pour chaque type de

groupement, un tableau regroupant les valeurs moyennes des événements essentiels concernant la reproduction des individus (ponte, éclosion, mort etc.) (Tableau 5).

Tout d'abord, on remarque que quelquefois les escargots s'accouplent deux fois avant de pondre. Dans certains cas, il y a des animaux qui pondent deux fois; souvent le nombre total des oeufs de deux pontes dépasse légèrement celui d'une seule ponte importante.

L'effet du groupement semble avoir une action sur la ponte et sa précocité. Pour le groupement “type 8 individus” aucune ponte n'est observée. Les premières pontes ont lieu chez les animaux du groupement “type 4,” mais la date moyenne de la première ponte de tous les escargots utilisés montre que ceux du groupement “type 2” pondent neuf jours avant les individus du “type 4” et 68 jours avant ceux du “type isolés” (Tableau 5). Bien que le grand diamètre moyen des individus au moment de la première ponte soit d'autant plus petit que l'effectif est plus important, le test de l'analyse de leurs variances ne présente pas une différence significative ( $P > 0.05$ ) (Tableau 5). Les pontes qui par la suite éclosent, représentent l'ensemble du groupement “type 4” (100%), 50% du “type 2” et 0% du “type isolés” (Tableau 5). Les individus isolés pondent au maximum 8 oeufs, dont le poids n'a pas été déterminé afin d'éviter de les détruire, bien que Wolda & Kreulen (1973) signalent que les manipulations des oeufs n'entraînent aucune perturbation sur leur développement et leur éclosion. En plus, des coupes histologiques effectuées sur une de leurs pontes montrent que les oeufs sont stériles; quant aux autres pontes, elles se dessèchent dans les mois suivants. Quant aux pontes des autres types de groupe-

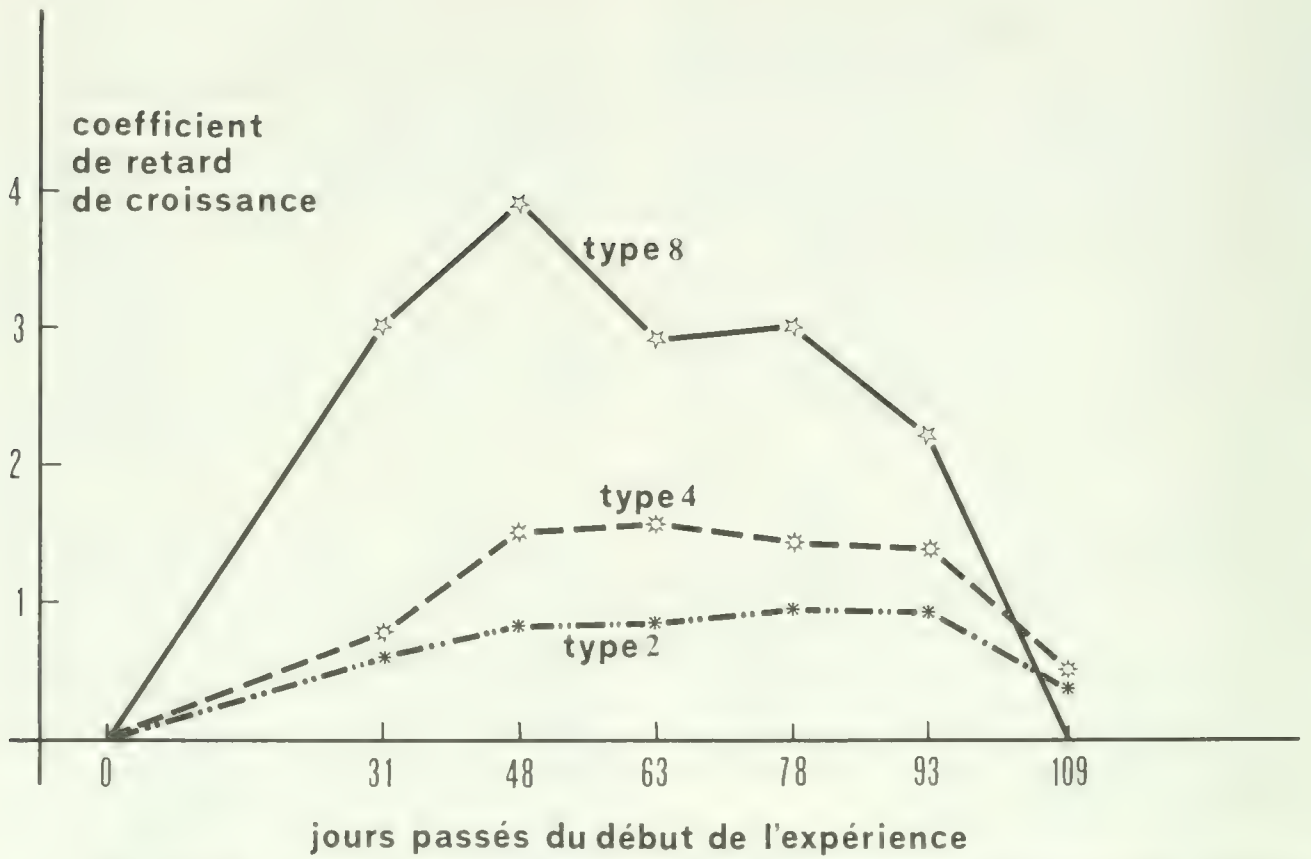

FIG. 1. Importance du "coefficient de retard de croissance" du grand diamètre de la coquille selon le type de "groupement des individus" chez *Theba pisana* (Müller).

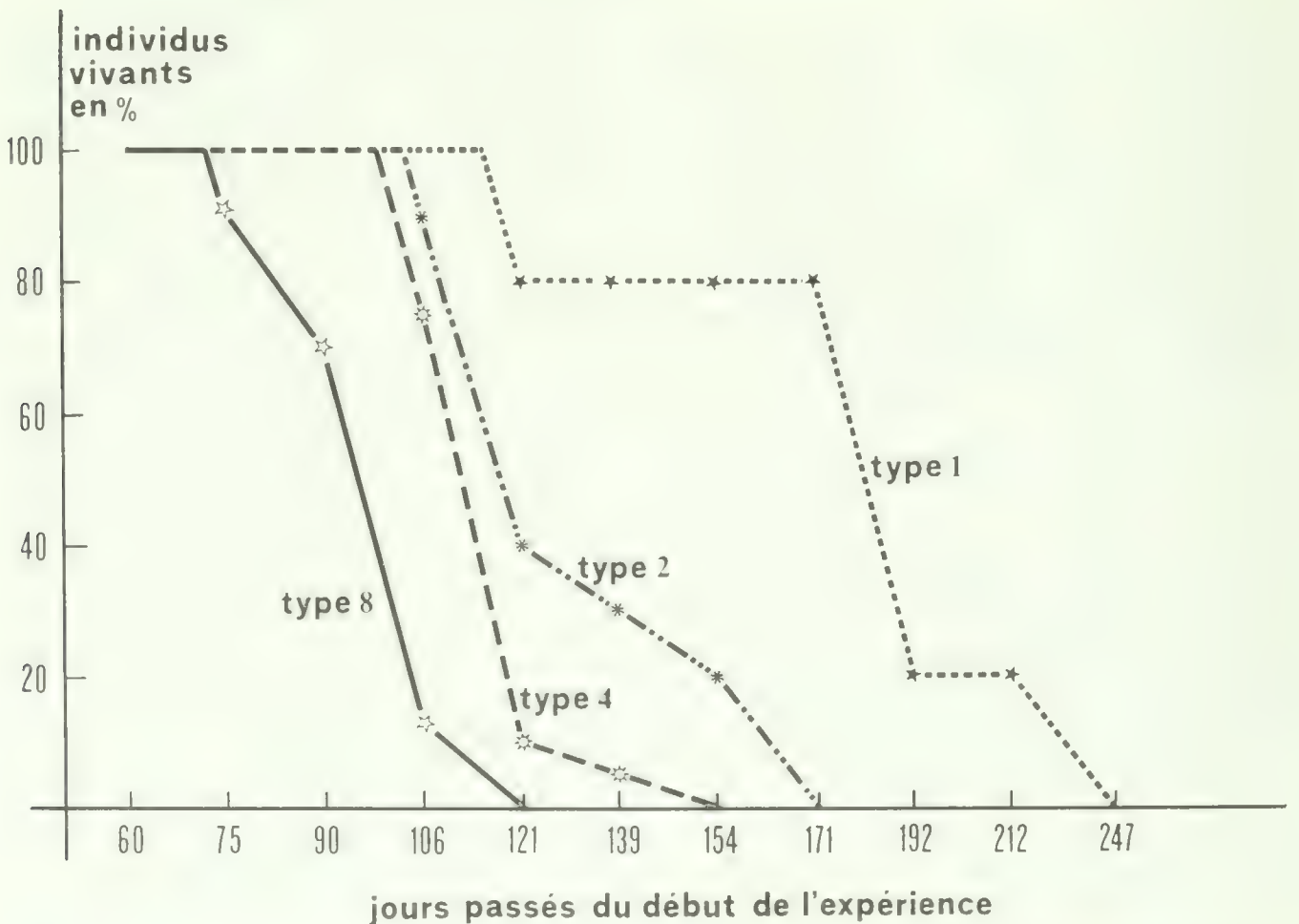

Fig. 2. Courbes de survie des individus de *Theba pisana* (Müller) en fonction du "type de leur groupement."

TABLEAU 5. Principaux résultats concernant l'influence de différents "types de groupement" sur la reproduction et la mort de *Theba pisana*.

Paramètres	Groupement "type 4"	Groupement "type 2"	Animaux isolés	Test de l'analyse de la variance entre les différents "types de groupement"
Date moyenne de la première ponte (en jours) $\pm$ écart-type	29 Juillet $\pm$ 14	20 Juillet $\pm$ 11	8 Octobre $\pm$ 28	P < 0.01
Grand diamètre moyen (en mm) $\pm$ écart-type	17.4 $\pm$ 1.1	17.8 $\pm$ 1.5	18.2 $\pm$ 1.0	P > 0.05
Nombre moyen d'oeufs $\pm$ écart-type	78.5 $\pm$ 19.4	38.5 $\pm$ 23.9	3.5 $\pm$ 3.1	P < 0.01
Poids moyen d'oeufs (en g) $\pm$ écart-type	0.58 $\pm$ 0.17	0.37 $\pm$ 0.04	—	P < 0.05
Durée moyenne entre ponte—éclosion (en jours) $\pm$ écart-type	17.0 $\pm$ 7.2	27.0 $\pm$ 7.6	—	P > 0.05
Pourcentage des pontes qui éclosent.	100% $\pm$ 0%	50% $\pm$ 5%	0% $\pm$ 0%	P < 0.05
Durée moyenne entre ponte-mort des animaux (en jours) $\pm$ écart-type	23.5 $\pm$ 10.7	31.3 $\pm$ 16.3	20.0 $\pm$ 16.7	P > 0.05

ment, le nombre moyen et le poids moyen d'oeufs pondus sont d'autant plus grands que l'effectif est plus important (Tableau 5). Plus la ponte est tardive et plus la durée de vie normale de l'animal est prolongée. Dans ce cas les animaux atteignent un grand diamètre plus important. Enfin, que la ponte soit précoce ou tardive, la durée de vie de l'animal, de la ponte à la mort, ne présente pas une différence significative ( $P > 0.05$ ) selon le test de l'analyse de la variance (Tableau 5).

#### *Influence du groupement des individus sur leur mortalité*

Les courbes de survie des individus en fonction de leur type de groupement (Fig. 2) montrent que la mortalité est particulièrement précoce et important chez les groupes de 8 individus, alors qu'elle est très faible pour les individus isolés.

## DISCUSSION

Tout d'abord il faut noter que les densités utilisés au laboratoire présentent une situation moyenne entre les densités animales trouvées sur le cordon dunaire d'une part, et dans l'arrière-pays d'autre part.

On constate que le groupement a un effet doublement inhibiteur sur la croissance de *Theba pisana*: d'une part en réduisant la taille maximale et d'autre part en abaissant la vitesse avec laquelle cette taille est atteinte. Cette relation inversée (taille-densité) coïncide avec celle observée chez la même espèce par Bigot (1967) aux départements des Bouches-du-Rhône, du Gard et du Vaucluse. Le même phénomène est signalé chez *Aeolidiella alderi* par Chevalier et col. (1974) et chez *Cepaea nemoralis* par Wolda (1969) et Williamson et col. (1976). Cette supériorité de la taille chez les animaux isolés ou appartenant aux faibles rassemblements de *Theba pisana*, est expliquée par Bigot (1967) comme "... un simple effet de compétition alimentaire (diminution de la ration à cause du gonflement de la population) ou d'une diminution du temps d'alimentation (la séparation des individus en grappe est moins rapide que celle d'individus isolés). Il est peu probable qu'il faille incriminer l'action défavorable d'un effet de groupe (Chauvin, 1952)." De plus, Eisenberg (1970) a montré chez *Lymnaea elodes* que la relation inversée entre la densité animale et la taille des individus disparaît avec l'additionnement de nourriture.

Au laboratoire, comme toutes les enceintes

d'élevage contiennent la même quantité de Ca, sous forme de mærl—le manque de Ca peut freiner la croissance (Thomas et col., 1975)—et comme la nourriture est toujours fournie en excès et qu'elle est en plus de la même qualité pour un jour donné dans toutes les enceintes d'élevage, on peut suggérer que c'est soit l'espace disponible (Tableau 1) soit les interactions chimiques ou comportementales (Williamson et col., 1976) soit les deux qui entraînent ces différences de croissance au sein de divers "types de groupements."

On note, en plus, que plus la densité est forte et plus la mortalité est précoce et importante. Il est possible que dans l'espace disponible les catabolites rejetés par les escargots (par exemple urée) et par les microorganismes associés avec eux ou les métabolites solubles des feuilles de laitue, d'une part inhibent la croissance et d'autre part entraînent la mortalité (Simpson et col., 1973; Thomas & Benjamin, 1974). Wright (1960) suggère que les phéromones en petites quantités peuvent être avantageux pour les animaux, mais en concentrations importantes limitent la densité de la population. Mais, les résultats précédents ne permettent pas de déterminer par quel moyen le groupement intervient dans la croissance et la mortalité; c'est plutôt une étude qui nous montre les effets du groupement et non pas les agents déterminants. Mais, d'après ce qu'il est généralement admis, l'intensité s'accroissant avec la densité, on serait plutôt en présence d'un effet de masse (Grassé, 1946).

A la suite, on note qu'au sein d'un groupement donné, un certain nombre d'individus présentent une croissance beaucoup plus lente que les autres; on le présente avec un coefficient qu'on appelle "le coefficient de retard de croissance." Plus l'effectif est important et plus le coefficient de retard de croissance est grand. Le même phénomène est observé chez *Biomphalaria glabrata* par Thomas & Benjamin (1974) et chez *Aeolidiella alderi* par Chevalier et col. (1974). En tenant compte du protocole expérimental, nous ne pensons pas que le facteur limitant soit la quantité de la nourriture (toujours fournie en excès), mais probablement la qualité de la nourriture ingérée par chaque individu de chaque enceinte d'élevage. Ce type de compétition, dite "scramble" par Nicholson (1955), se caractérise par le fait que le "compétiteur" le plus efficace est celui

qui peut obtenir et utiliser la partie de la nourriture qui a la valeur la plus nutritive. Ainsi, plus l'effectif est important, et plus difficile est l'accessibilité par les individus les moins efficaces à la partie de la nourriture la plus nutritive. Eisenberg (1966) a d'ailleurs montré chez *Lymnaea elodes* que la qualité de nourriture est nécessaire pour la croissance maximale.

Enfin, on constate que le groupement des individus a une action sur la précocité de la ponte, le nombre d'oeufs et l'éclosion. Tout d'abord, il faut rappeler que les animaux du groupement "type 8" meurent sans pondre et que les animaux isolés pondent très peu d'oeufs stériles (l'autofécondation n'arrive pas chez cette espèce) et beaucoup plus tard que les individus des autres "types de groupement." Quant aux "types 2 ou 4," nous constatons que les escargots du "type 4" ont au moment de la ponte un grand diamètre plus petit que celui des individus du "type 2," que le nombre et le poids d'oeufs de leurs pontes sont plus grands et que tous leurs oeufs éclosent. La différence de taille des individus au moment de la ponte, constaté aussi chez *Aeolidiella alderi* par Chevalier et col. (1974), peut être expliquée par la différence de la vitesse de croissance que montrent les deux "types de groupement." L'influence du groupement sur la productivité est montrée chez divers Pulmonés par Wolda (1963), Steen (1967), Steen et col. (1973), Mooij-Vogelaar & Steen (1973), Eisenberg (1970), mais dans leurs expériences c'est la quantité ou la qualité de la nourriture qui provoquent ces différences. Dans notre cas, nous pensons que ce sont les échanges tactiles ou chimiques (phéromones) qui les provoquent; il semblerait, d'ailleurs, que la densité optimale au point de vue productivité est celle du groupement "type 4" (185 individus/m<sup>2</sup>).

#### TRAVAUX CITES

- ALLEE, W. G., 1928, Studies in animal aggregations: mass protection from fresh water for *Procerodes*, a marine turbellarian. *Journal of Experimental Zoology*, 50: 239-318.
- ASTRE, G., 1921, Sur la nature physique de la cause qui, dans les dunes maritimes, régit l'ascension des Mollusques le long des tiges à faible feuillage. *Bulletin de la Société d'Histoire naturelle de Toulouse*, 49: 162-164.
- BIGOT, L., 1967, Recherches sur les groupements des Gastéropodes terrestres: la constitution des "grappes." *Vie et Milieu*, 18(1C): 1-27.
- CHAUVIN, R., 1952, L'effet de groupe. *Colloque*

- C.N.R.S., "Structure et Physiologie des Sociétés animales," 34: 81-90, Editions C.N.R.S.
- CHEVALIER, F., MOCQUARD, J. P. & TARDY, J., 1974, Croissance et précocité d'*Aeolidiella alderi* (Cocks), (Mollusque Nudibranche): effets du groupement et de la température. *Bulletin de la Société Zoologique de France*, 99: 601-621.
- CHEVALLIER, H., 1974, Les grands *Arion* de France (Mollusca, Pulmonate): Taxonomie, biogéographie, écologie, polymorphisme. Croissance et cycle biologiques. Thèse, Doctorat de l'Université, Paris VI.
- DAGUZAN, J., 1975, Contribution à l'écologie des Littorinidae (Mollusques Gastéropodes Proso branches), recherches écophysiologiques chez quatre espèces: *Littorina neritoides* (L.), *Littorina saxatilis* (Olivi), *Littorina littorea* (L.) et *Littorina littoralis* (L.) Thèse, Docteur ès-Sciences, Rennes, 400 pp.
- EISENBERG, R. M., 1966, The regulation of density in natural populations of the pond snail *Lymnaea elodes*. *Ecology*, 47: 890-906.
- EISENBERG, R. M., 1970, The role of food in the regulation of the pond snail *Lymnaea elodes*. *Ecology*, 51: 680-684.
- ENGEL, H., 1957, Ökologisch-Faunistische Studien im Rhône-Delta, unter besonderer Berücksichtigung der Mollusken. *Bonner Zoologische Beiträge*, 8: 5-55.
- GRASSE, P. P., 1946, Sociétés animales et effet de groupe. *Experientia*, 2: 77-82.
- GRASSE, P. P., 1968, Introduction. *Colloque C.N.R.S.*, "L'effet de groupe chez les animaux," 173: 11-14, Editions C.N.R.S.
- HERZBERG, R., 1965, Crowding as a factor in growth and reproduction of *Helix aspersa*. *American Zoologist*, 5: 254.
- HUXLEY, J. S. & TEISSIER, G., 1936, Terminologie et notation dans la reproduction de la croissance relative. *Comptes Rendus des Séances de la Société de Biologie et des ses filiales*, 121: 934-936.
- LAZARIDOU-DIMITRIADOU, M., 1978, Contribution à l'écophysiologie d'un Gastéropode Pulmoné dunicole: *Euparypha pisana* (Müller) du littoral armoricain. Thèse. Docteur 3<sup>ème</sup> cycle, Rennes, 279 p.
- LE MASNE, G., 1952, Classification et caractéristiques des principaux types de groupements sociaux réalisés chez les Invertébrés. *Colloque C.N.R.S.*, "Structure et Physiologie des Sociétés animales," 34: 19-70, Editions C.N.R.S.
- MOOIJ-VOGELAAR, J. W., JAGER, J. C. & VAN DER STEEN, W. J., 1970, The effect of density changes on the reproduction of the pond snail *Lymnaea stagnalis* (L.). *Netherlands Journal of Zoology*, 20: 279-288.
- MOOIJ-VOGELAAR, J. W. & VAN DER STEEN, W. J., 1973, Effects of density on feeding and growth in the pond snail *Lymnaea stagnalis* (L.). *Proceedings of the Koninklijke Nederlandse Akademie van Wetenschappen*, Series C, 76: 61-68.
- NICHOLSON, A. J., 1955, An outline of the dynamics of animal population. *Australian Journal of Zoology*, 2: 9-65.
- OOSTERHOFF, L. M., 1977, Variation in growth rate as an ecological factor in the landsnail *Cepaea nemoralis* (L.). *Netherlands Journal of Zoology*, 27: 1-132.
- PITCHFORD, G. W., 1954, Eggs of *Theba pisana*. *Journal of Conchology*, 24: 22.
- RABAUD, E., 1927, Les passissements des mâles d'*Halictes*. *Bulletin biologique de la France et de la Belgique*, 61: 163-185.
- RABAUD, E., 1929, Phénomène social et Sociétés animales. *Bulletin biologique de la France et de la Belgique*, 63: 377-398.
- SIMPSON, A. W., THOMAS, J. D. & TOWNSEND, C. R., 1973, Social behaviour in the freshwater pulmonate snail *Biomphalaria glabrata* (Say). *Behavioural Biology*, 9: 731-740.
- STEEN, W. J. VAN DER, 1967, The influence of environmental factors on the oviposition of *Lymnaea stagnalis* (L.) under laboratory conditions. *Archives Néerlandaises de Zoologie*, 17: 403-468.
- STEEN, W. J. VAN DER, JAEGER, J. C. & TIEMERSMA, D., 1973, The influence of food quality on feeding, reproduction and growth in the pond snail *Lymnaea stagnalis* (L.) with some methodological comments. *Proceedings of the Koninklijke Nederlandse Akademie van Wetenschappen*, Series C, 76: 47-60.
- THOMAS, J. D. & BENJAMIN, M., 1974, The effects of population density on growth and reproduction of *Biomphalaria glabrata* (Say) (Gastéropoda: Pulmonata). *Journal of Animal Ecology*, 43: 31-50.
- THOMAS, J. D., GOLDSWORTHY, G. J. & ARAM, R. H., 1975, Studies on the chemical ecology of snails: the effect of chemical conditioning by adult snails on the growth of juvenile snails. *Journal of Animal Ecology*, 44: 1-28.
- WILLIAMSON, P., CAMERON, R. A. D. & CARTER, M. A., 1976, Population density affecting adult shell size of *Cepaea nemoralis* (L.) *Nature*, 263: 496-497.
- WOLDA, H., 1963, Natural populations of the polymorphic landsnail *Cepaea nemoralis* (L.). *Archives Néerlandaises de Zoologie*, 15: 381-471.
- WOLDA, H., 1969, Stability of a steep cline in morph frequencies of the snail *Cepaea nemoralis* (L.). *Journal of Animal Ecology*, 38: 623-635.
- WOLDA, H. & KREULEN, D. A., 1973, Ecology of some experimental populations of the landsnail *Cepaea nemoralis* (L.). II Production and survival of eggs and juveniles. *Netherlands Journal of Zoology*, 23: 168-188.
- WRIGHT, C. A., 1960, The crowding phenomenon in laboratory colonies of freshwater snails. *Annals of Tropical Medicine and Parasitology*, 54: 244-232.
- YOM-TOV, T., 1972, Field experiments on the effect of population density and slope direction on the reproduction of the desert snail *Trochoidea (Xerocrassa) seetzeni*. *Journal of Animal Ecology*, 41: 17-22.

## ABSTRACT

EFFECTS OF "CROWDING" ON GROWTH, MORTALITY RATE AND REPRODUCTION OF *THEBA PISANA* (MULLER) (GASTROPODA PULMONATA)

Maria Lazaridou-Dimitriadou and Jacques Daguzan

This article deals with the effect of "crowding" on growth, reproduction and mortality of *Theba pisana* (Müller) hatched in the laboratory. From a series of experiments, it is determined that the higher the number of grouped individuals the smaller the growth rate and the higher the mortality rate. On the other hand, it seems that a certain population density is necessary for the possibility of this species to reproduce efficiently.



## THE OSPHRADIAL COMPLEX OF TWO FRESHWATER BIVALVES: HISTOLOGICAL EVALUATION AND FUNCTIONAL CONTEXT

Louise Russert Kraemer

*Department of Zoology, University of Arkansas,  
Fayetteville, Arkansas 72701, U.S.A.*

### ABSTRACT

From studies based largely on two species of freshwater bivalves, *Lampsilis ventricosa ovata* (Barnes), a unionacean, and *Corbicula* cf. *C. fluminea* (Müller), a sphaeriacean, osphradia are seen to be located within the roof of the exhalant chamber just under the visceral ganglion. In turn the visceral ganglion is positioned anteroventral to the posterior adductor muscle. Extensive serial section study of the osphradial tissues of *C. fluminea* reveals each osphradium to be comprised of (1) a characteristic epithelium of columnar epithelial cells which lack a basement membrane, but which are profusely innervated by neuronal fibers from (2) clusters of nerve fibers which parallel the base of the epithelium and also send fibers into the visceral ganglion, and (3) clusters of neuronal soma near the base of the epithelium, which send fibers into the visceral ganglion. The clusters of nerve fibers do not constitute a distinct osphradial nerve, nor do the neuronal soma constitute a discrete osphradial ganglion.

Three-dimensional appearance of the osphradia is that of two narrow, pie-wedge-shaped organs located at right angles to the longitudinal axis of the animal. The narrowing tips of the organs approach but do not touch in the midline of the ventral surface of the visceral ganglion. Neuroanatomical context of the osphradia is examined in order to test some assumptions implicit in a current hypothesis that bivalve osphradia may function as particle-size sensors which serve to regulate activity of gill cilia. Neuroanatomically, the osphradia are closely associated with nerves which supply the posterior adductor muscle and with nerves which supply kidney tissue. The osphradia do not have a close anatomical association with branchial nerves or with the ganglionated roots of those nerves.

A simple but repeated error may account for the inchoate state of literature on bivalve osphradia. A misrepresentation of osphradia in bivalves as inverted from their normal position may stem from an effort by early workers to homologize bivalve osphradia with those of gastropods. The error may be related to an incorrect assumption by some authors that bivalve osphradia are associated with the roof of the inhalant rather than the exhalant chamber. New hypotheses are needed concerning the function of bivalve osphradia. Hypotheses should incorporate the new information presented here concerning the precise anatomical site, histological organization, three-dimensional structure and neuroanatomical context of these paired organs. On the basis of findings presented here, it may be that bivalve osphradia function as light sensors which regulate seasonal behavior or reproductive physiology. Alternatively, it might be that bivalve osphradia function not only in control of fluid movement through the exhalant chamber, but also in adduction of the shell valves.

### INTRODUCTION

A word taken from the Greek, "osphradion" for "strong scent," has for years been applied to a single or paired, putative sense organ which occurs commonly among aquatic gastropods, near their visceral ganglion at the outer side of the gill (Lankester, 1883). Hyman (1967) reviewed findings of workers who noted that the gastropod osphradium takes varied form: as an elongate ridge or swelling, as a pitted swelling, as a raised patch of pigmented or unpigmented epithelium, as a row of warts, or as resembling a

well differentiated, miniature bipectinate gill. Careful comparative histological study of gastropod osphradia has been done, especially by Demal (1955); and ultrastructure studies have been made by Anderson (1963), Simpson (1971), Benjamin (1971), Crisp (1973), Alexander & Weldon (1975), and Newell & Brown (1977).

Yonge (1947) analyzed structural and functional context of the osphradium in aspidobranch gastropods. Yonge opines (personal communication and 1947) that osphradia were originally tactile receptors which detected the amount of sediment in the water;

and that osphradia function as chemoreceptors in carnivores like the neogastropods *Buccinum* and *Nassarius*. Physiological and behavioral studies of gastropod osphradia seem to be primarily those of Michelson (1960), Brown & Noble (1960), Kohn (1961), Bailey & Laverack (1963), Carr (1967), Jahan-Parwar et al. (1968), Bailey & Benjamin (1968), Stinnakre & Tauc (1969), von Baumgarten et al. (1968), Jahan-Parwar et al. (1969), Townsend (1973), Phillips (1975), Kamardin (1976), and Sokolov & Kamardin (1977).

In bivalved mollusks neither the anatomical, histological nor physiological attributes of the osphradium seem to be clearly understood. Many authors (e.g. Yonge, 1947; Bayne et al., 1976) speculate that the osphradium may not be homologous with that of a gastropod. Essentially histological studies of Freidenfelt (1904), Dakin (1910, 1928) and Stork (1934) provide limited information on the organization of the bivalve osphradium. Some confusion in the literature is mirrored in the fact that Bullock & Horridge (1965) have reprinted Dakin's (1910) histological drawing of *Ensis*, and seem unaware that it is labelled just as Dakin drew it, *upside down*. Stork's (1934) histological drawings show the same incorrect interpretation, as Stork consistently drew sections of osphradia of bivalves upside down. Apparently there has been misrepresentation of the anatomy and anatomical context of the bivalve osphradium which has seriously affected a postulational-deductive process in studies of the organ's structure and function. This matter will be discussed further below.

No physiological work on bivalve osphradia has been found in the literature reviewed for this study. Some workers have hypothesized that the bivalve's osphradium may aid in the regulation of ciliary activity in the gills (e.g. Aiello & Guideri, 1964). Some workers who have done experimental studies to determine physiological bases of ciliary activity in bivalve gills are Grave & Schmitt (1925) on *Anodonta*, *Mya* and *Lampsilis*, Setna (1930) on *Pecten*, Lucas (1931) on *Mytilus* and *Megalonaias*, Bulbring et al. (1953), Aiello (1960) on *Mytilus edulis*, Gosselin et al. (1962), and Aiello & Guideri (1964) on *Mytilus edulis*. Results and conclusions drawn from these studies will be evaluated below.

In this paper I hope to clarify the structural and functional context of osphradia in certain freshwater bivalves. To do this I will (1) delineate the precise location and orientation of

the osphradia in two species of freshwater bivalved mollusks, *Lampsilis ventricosa ovata* (Barnes) and *Corbicula* cf. *C. fluminea* (Müller); (2) characterize in detail the histological organization of the osphradia; (3) summarize the three-dimensional anatomy of the osphradia as revealed by serial sections; (4) examine the neuroanatomical context of the osphradia, especially as it clarifies objection to a current hypothesis that bivalve osphradia may function to regulate gill cilia activity; and (5) present alternative hypotheses for the role of osphradia in bivalve mollusks.

## MATERIALS AND METHODS

The present study of freshwater bivalve osphradia was preceded and accompanied by prolonged behavioral observations of living bivalves in their natural habitat and in laboratory aquaria. From behavioral studies of *L. ventricosa* and of *C. fluminea*, it was possible to develop an understanding of the structures of the exhalant and inhalant chambers and siphons, and their relation to siphoning, shell valve adduction and locomotion in living animals. Some of these findings are described elsewhere (Kraemer, 1970, 1977).

Several dozen neuroanatomical dissections of relaxed tissues, both fresh and preserved, were made of the two bivalve species. Histological material used included visceral ganglion and associated pallial tissues of five *L. ventricosa*, and at least 15 whole, serially sectioned *C. fluminea*, 2 mm to 20 mm long. Serial sections were mostly sagittal, though some were transverse, some frontal, and were made from animals sacrificed in July, August, September, January and March. Animals of *L. ventricosa* used in this study were primarily from the White River and tributaries in northwestern Arkansas, and from the Arkansas River in central Arkansas and from the Buffalo River in northwestern Arkansas. *C. fluminea* used were from the Arkansas River in central Arkansas and from the Buffalo River in northwestern Arkansas. All animals were relaxed in Nembutal solution, fixed in Bouin's fluid, and preserved in 70% ethanol. An aniline blue variation of Mallory's triple staining technique was used (Schmitz, 1967). Photomicrographs were made with a 35 mm camera in conjunction with a Leitz Ortholux microscope equipped for bright-field transmitted light, and with a 35 mm Wild MKa 1 camera in conjunction with a Wild M5 stereomicroscope.

## LIST OF ABBREVIATIONS IN FIGURES

A	anus
AA	anterior adductor muscle
AS	edge of exhalant siphon
BG	basal granule
BM	basement membrane
BN	branchial nerve
BS	edge of inhalant siphon
BV	blood vessel
C	cilia
CC	ciliated cell
CT	connective tissue
CVC	cerebrovisceral connective
E	epithelium
EC	exhalant chamber
ES	exhalant siphon
F	foot
G	gill
GRB	ganglionated root of branchial nerve
IS	inhalant siphon
LO	location of osphradium
LOG	left outer gill
LP	labial palp
N	nerve fibers
NA	nerve supplying posterior adductor muscle
NK	nerve supplying kidney
NP	neuropil
OE	osphradial epithelium
OG	ganglionated osphradial tissue
ON	osphradial nerve fibers
PA	posterior adductor muscle
PN	pallial nerve
RBC	roof of branchial chamber
REC	roof of exhalant chamber
RIC	roof of inhalant chamber
RPT	right pallial nerve trunk
S	neuronal soma
SP	soma of osphradial neuron terminating in distal "pore"
U	umbo
VG	visceral ganglion

## RESULTS

Location and orientation of the osphradia in *L. ventricosa* and *C. fluminea*

Osphradia are located in a sheath of loose connective tissue, along with the butterfly-shaped visceral ganglion and its other associated structures, just anteroventral to the posterior adductor muscle and *within* the roof of the exhalant canal (Fig. 1, LO, VG). It is

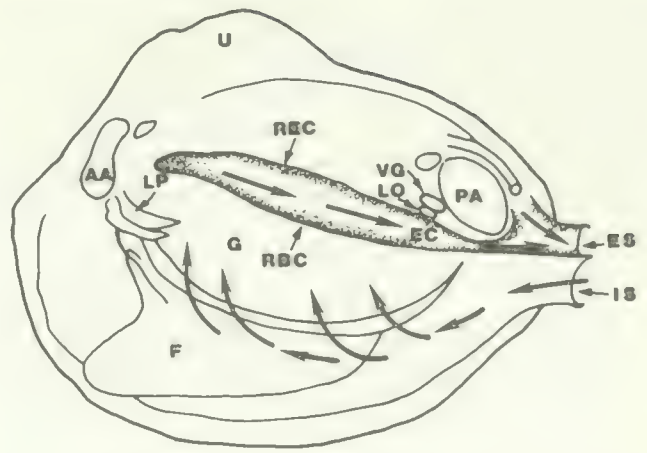

FIG. 1. Schematic diagram of a freshwater bivalve with left valve and left lobe of mantle removed to show location of visceral ganglion (VG) and of osphradia (LO) within the roof of the exhalant chamber (REC). Note that the ventral surface of the osphradia is exposed to excurrent fluids and not to incurrent fluids.

important to note that the floor of the exhalant canal, which is also the roof of the branchial cavity, is formed by the fusion of the dorsal portions of the demibranchs. Ortmann carefully examined the branchial roof in unionids ("najades"). He referred to it as the *diaphragm* and described it thus (1911: 288):

"posteriorly to the abdominal sac (visceral mass) and foot, the inner laminae of the two inner gills unite in the median line of the body. . . . By this union, together with the connection of the outer laminae of the outer gills with the mantle, a complete separation of the branchial chamber from the posterior part of the suprbranchial canals (cloacal chamber) is effected by a septum or diaphragm, which forms a horizontal division, from which the gills hang down. . . ."

The floor of the exhalant chamber is thus the roof ("diaphragm") of the inhalant or branchial cavity. Therefore, the visceral ganglion and its closely associated osphradia are directly exposed to fluid moving *not* through the incurrent siphon of the bivalve animal (as has been stated in the literature), but to fluid moving through the *exhalant* canal. That the foregoing is not generally understood by biologists is underscored, for example, by the fact that "osphradium" is defined as follows by Pennak (1964: 365):

"*osphradium*. Small sensory area in the incurrent siphon of pelecypod and gastropod mollusks; presumably a chemoreceptor sensitive to incoming water."

In contrast, in evident paraphrase of Yonge (1947), the obvious paradox of the bivalve osphradium's actual anatomical *site*, and the supposed *function* investigators have hypothesized for it was stated by Charles (1966: 504):

"The possible function of these organs (osphradia) is obscure. As far as testing the respiratory current is concerned, water has to pass through the ctenidia before reaching these organs, and the sensory tentacles fringing the inhalant opening would be better suited for this function."

To visualize the location of the freshwater bivalve's osphradia, one may examine the *in situ* dissection of the visceral ganglion of *L. ventricosa* (Fig. 2). Osphradial tissues are appended in two triangle-shaped regions to the ventral surface of the ganglion, as will be described in detail in the histological discussion below, and as shown in the diagrammatic insert for Fig. 2.

When an organism's fresh tissues are examined from the ventral aspect with a dissecting microscope, the membranous tissue

comprising the roof of the exhalant chamber in the region immediately adjacent to the ventral surface of the visceral ganglion, may show a pinkish cast, and may bulge very slightly. There is no obvious manifestation of the osphradium, however, in fresh tissue. Histological study of serial sections of the animal is required to verify that the aforementioned pinkish area is indeed the vicinity of the osphradial tissues.

#### Histological organization of the osphradia of *C. fluminea*

As shown in Fig. 3, each osphradium is comprised of three distinct kinds of tissues: the osphradial epithelium (OE), clusters of osphradial nerve fibers (ON), and ganglionated tissue (OG).

The osphradial epithelium, even at low magnification, has a distinctive appearance. Published figures and histological descriptions of certain bivalve osphradia (e.g. Dakin, 1910 for *Pecten*; Stork, 1934 for *Cardium edule*, *Mactra subtruncata*, *Sphaerium*



FIG. 2. Visceral ganglion (VG) of female freshwater bivalve, *Lampsilis ventricosa ovata*, *in situ*, viewed from ventral aspect. Left and right mantle lobes and left and right gills have been spread apart. Roof of inhalant (branchial) chamber has been cut and removed. Roof of exhalant chamber has been removed to expose ventral surface of the visceral ganglion. Insert: diagram indicating location of osphradia (LO) on ventral surface of visceral ganglion.

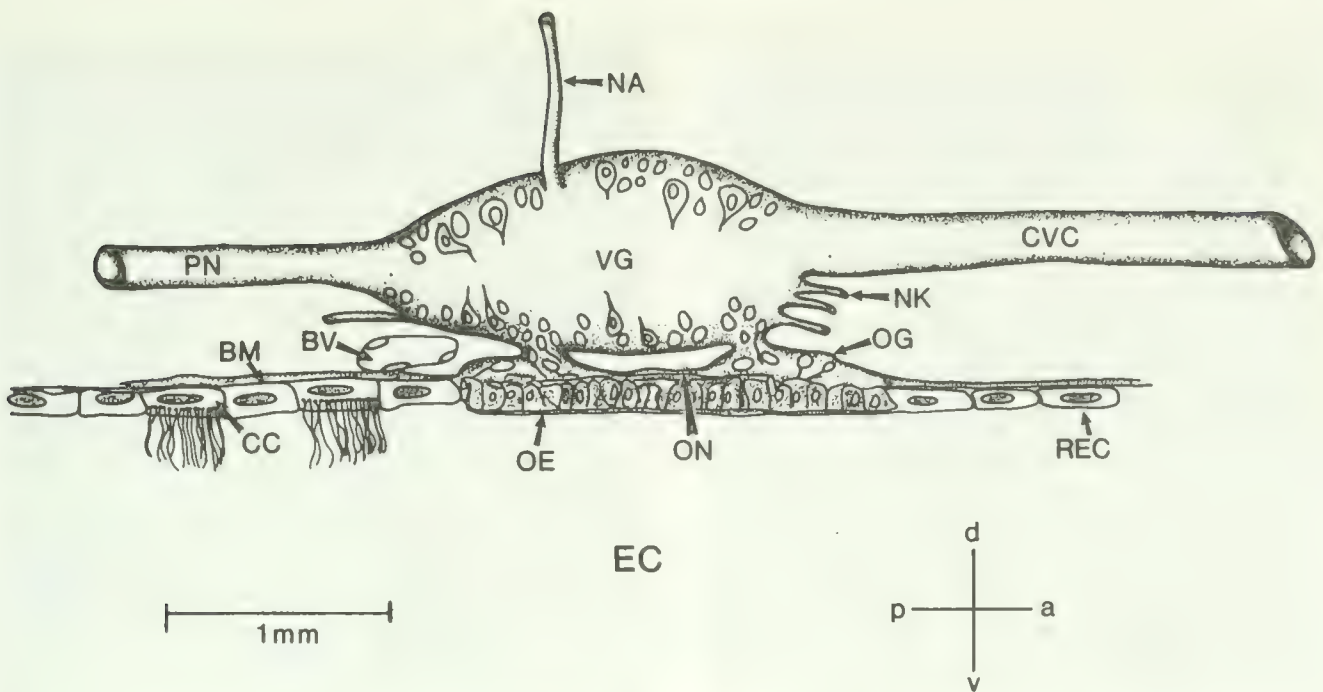

FIG. 3. Semi-diagrammatic, summary sketch showing sagittal section of osphradial tissues (OE, OG, ON) of the bivalve, *Corbicula* cf. *C. fluminea*, and some related structures described in this article.

*corneum*, *Pisidium henslowanum*) show a histologically discrete epithelium on the dorsal surface. It is obvious that a similar peculiar epithelium does indeed constitute the *ventral* boundary of the osphradial tissue of *C. fluminea*. Furthermore, examination of thousands of serial sections of these clams allows verification that the osphradial epithelium is found nowhere else among the clam's tissues.

Osphradial epithelial cells are at once discernible from neighboring cells as (i) smaller and more crowded, (ii) columnar, (iii) having oval nuclei with their long axes at right angles to the surface. Under oil immersion, typical osphradial epithelial cells also (iv) have a granular cytoplasm and (v) *lack* a basement membrane (Figs. 3, 4, OE).

In lieu of a basement membrane, small clusters of nerve fibers and groups of neuronal soma closely parallel the base of the osphradial epithelium, and branch extensively among the cells of the osphradial epithelium. In their descriptions of gastropod osphradia, other authors (e.g. Demal, 1955) detail an "osphradial nerve" and an "osphradial ganglion" as conspicuous, well-developed entities. In the bivalve osphradium examined here the nerve fibers are not organized into a distinct osphradial nerve. Similarly, the 8 to 10 clusters of neuronal soma associated with each osphradium are not grouped into an organized ganglion. The histological figures of

other authors show no clearly defined nerve or ganglion as part of the bivalve osphradium, even though they are so labeled. I suspect that serial sections of other bivalve osphradia would show neuronal tissue similar to that of *C. fluminea*.

Innervation of the osphradial epithelium is by means of the fibers mentioned above which parallel its base and which send abundant, branching, naked nerve fibers to outline or obliquely cross the surface of many of the epithelial cells, seeming to form a neuronal reticulum there. Contrary to what other workers have stated (e.g. Dakin, 1910), osphradial epithelial cells are not triangular. They may, however, have seemed to other authors to be triangular, as so many nerve fibers do lie obliquely across the columnar epithelial cells. Most of the nerve fiber endings do not seem to penetrate the distal epithelial surface. A few osphradial epithelial cells seem to be extensions of underlying neuronal soma. These soma extend through the epithelium to terminate in a distal "pore" (Fig. 4C, SP).

In sagittal sections near the proximal end of each osphradium, the organ typically appears as shown in Figs. 3 and 4. Sagittal sections near the distal end of the organ show a much more extensive osphradial epithelium, osphradial nerve fibers, and osphradial ganglionated tissue (Fig. 5, OE). Also at the distal end of the organ, the visceral ganglion itself

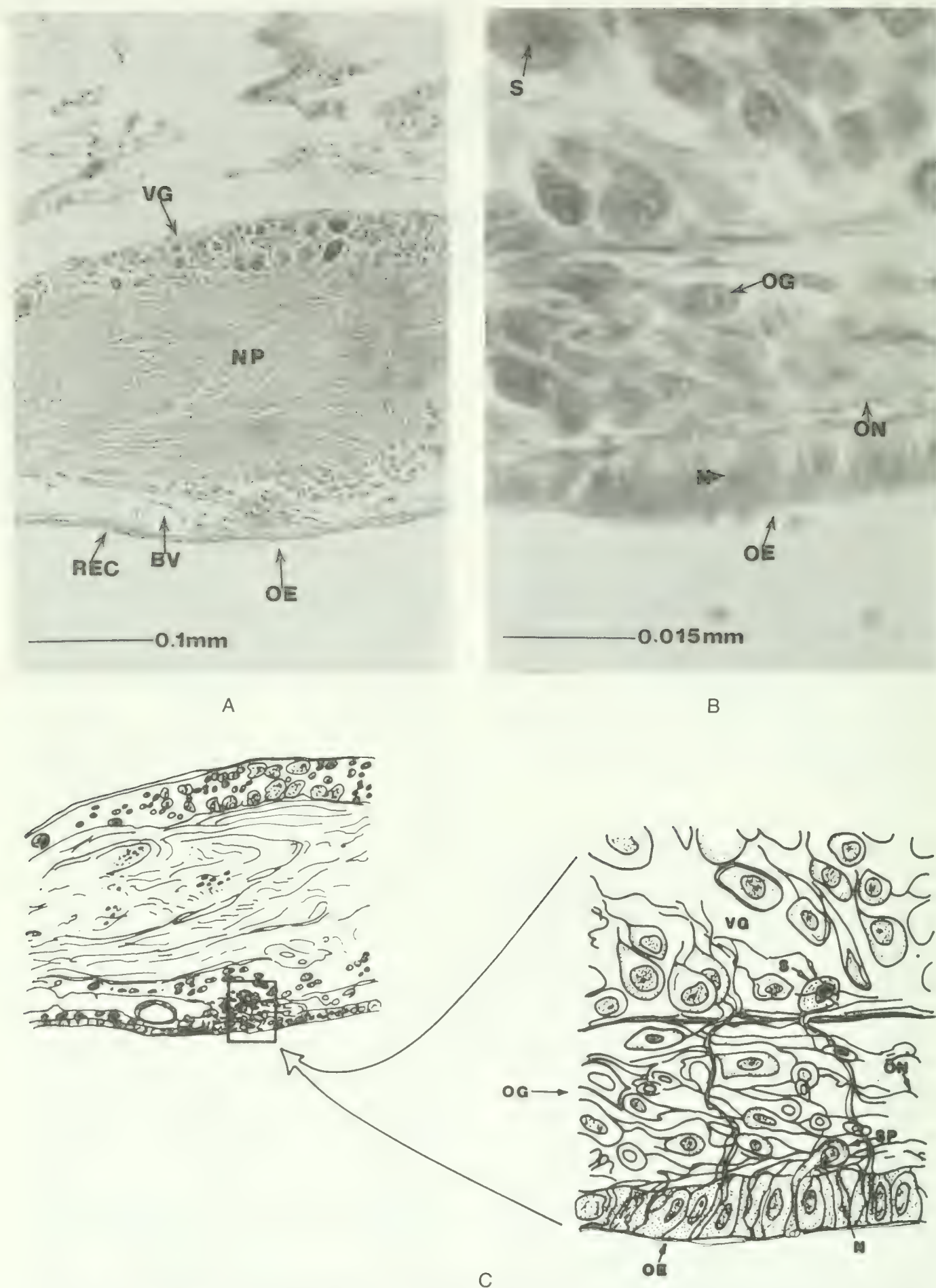

FIG. 4. A. Low-power photomicrograph of sagittal section of visceral ganglion of *Corbicula* cf. *C. fluminea* and proximal end of osphradium. B. Enlargement of Fig. 4A, showing detail of osphradium. C. Semi-diagrammatic sketch of sections comparable to Figs. 4B, C, showing the several tissue elements comprising the osphradium (OE, OG, ON) and relation of the tissue elements to the visceral ganglion (VG).

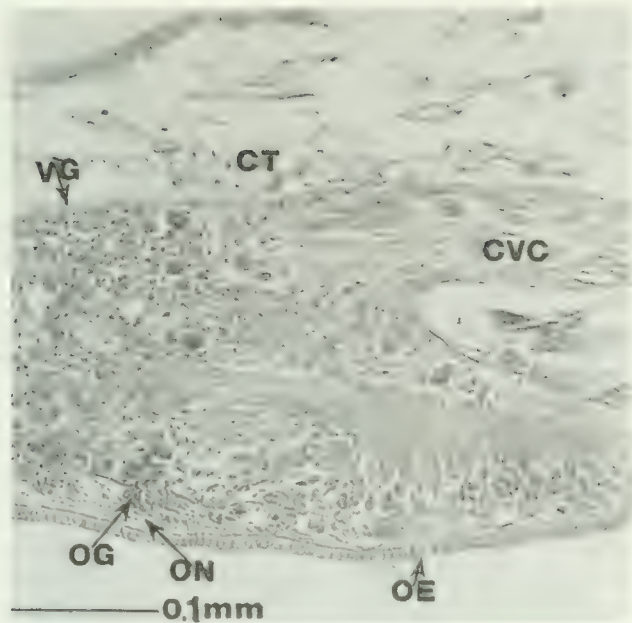

FIG. 5. Photomicrograph of lateral sagittal section through visceral ganglion (VG) and osphradium (OE, OG, ON) of *Corbicula* cf. *C. fluminea*. Note that the visceral ganglion appears appressed to the osphradial epithelium from the point marked OE to the far right side (anterior) of the picture.

seems to be closely appressed to the osphradial epithelium, and thus to the roof of the exhalant chamber (Fig. 4, VG).

Gastropod osphradial epithelium has been evaluated by others (Demal, 1955; Bullock & Horridge, 1965; Hyman, 1967) as consisting of groups of one or another kind of cell. Yonge noted that (1947: 511) "... the epithelium contains mingled sensory, mucous and ciliated cells..." in aspidobranch gastropods. Neither of the foregoing findings correspond to observations made for bivalve osphradial epithelium in this study. The typical osphradial epithelium for *C. fluminea* has already been described above. However, there are at least two other kinds of cells comprising the epithelium of the rest of the exhalant chamber roof in *C. fluminea*. Both kinds resemble cell types ascribed to osphradial epithelium in gastropods by other workers: (1) goblet-shaped cells (referred to as mucocytes by Demal, 1955, and others); and (2) rectangular, ciliated cells (Figs. 3, CC, 6A, CC, 6B). The latter show a line of very slender cilia emanating from an apparent row of basal granules in the long axis of the cell. The ciliary row may or may not originate at the distal surface of the cell. Most of the ciliated cells are scattered along the exhalant chamber roof, usually posterior to the osphradial epithelium. Some of these cells are also to be found anterior to the osphradium.

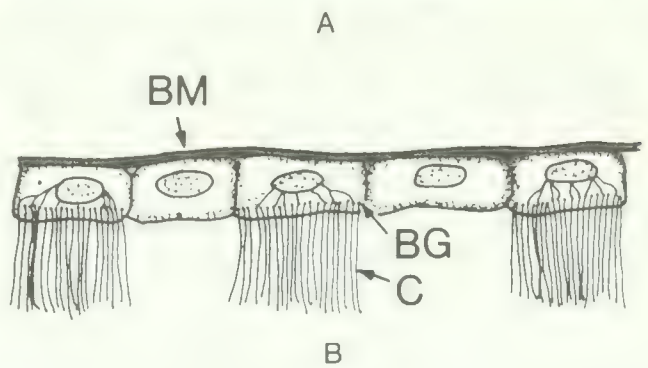
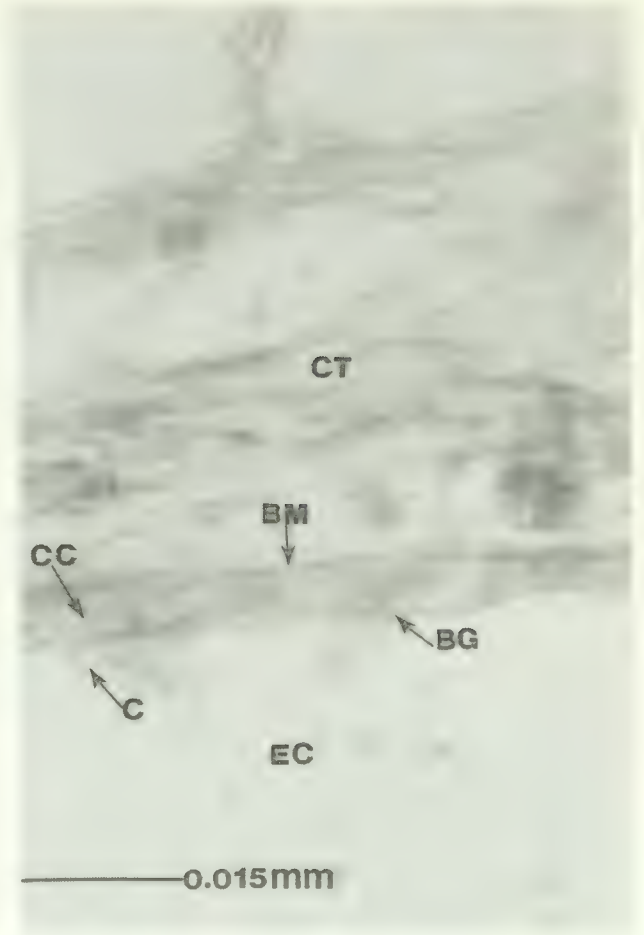

FIG. 6. A. Photomicrograph of roof of exhalant chamber of *Corbicula* cf. *C. fluminea*, posterior to the osphradium, showing characteristic, typical rectangular ciliated epithelial cells (CC). B. Sketch showing detail of ciliated cells from Fig. 6A. Note the conspicuous basement membrane (BM) in both 6A and 6B.

The three-dimensional anatomy of the osphradia

As revealed by extensive serial section study, the three-dimensional appearance of the osphradia in *C. fluminea* is that of two narrow, pie-wedge-shaped organs located at right angles to the longitudinal axis of the clam (Fig. 2, LO). The narrowing tips of the wedge-shaped organs approach but do not touch in the midline of the ventral surface of the



FIG. 7. Photomicrograph of midsagittal section of visceral ganglion of *Corbicula* cf. *C. fluminea*. Osphradial tissue is not evident here, as this region is between the two osphradia.

visceral ganglion. A sagittal series of microscopic sections verifies that a distance of about  $25\ \mu\text{m}$  separates the two osphradia from each other in the midline. No contiguous or other osphradial tissue is found in midsagittal sections of this region (Fig. 7).

The wedge-shaped osphradia in a mature clam may measure about  $100\ \mu\text{m}$  from their tips near the midline to their lateral aspect. Each osphradium tapers from about  $80\ \mu\text{m}$  at its lateral limit (Fig. 5), to  $10\ \mu\text{m}$  at its medial tip. Medially, each osphradium is thinnest (about  $15\ \mu\text{m}$ ), being comprised of little more than a short strip of epithelial cells and a few nerve fibers. At its wide, lateral margin, each osphradium contains many more neuronal soma and fibers, and attains a thickness of about  $50\ \mu\text{m}$  (Fig. 5).

#### Neuroanatomical context of the osphradial tissues

As noted in the introduction of this paper, prior investigators have failed to determine the function of any bivalve osphradium. Some

limited physiological investigations have seemed to other workers to implicate bivalve osphradia in regulation of ciliary activity of the gills (Aiello & Guideri, 1964). To test some assumptions implicit in this hypothesis, it is important to determine the neuroanatomical context of osphradial tissue in *C. fluminea* in some detail.

The neuroanatomical context of osphradial tissues was examined in careful serial section study. Anterior and medial to the osphradial region (Fig. 3), there are at least a dozen tiny nerves which extend from the visceral ganglion to tissues of the kidney (Fig. 3, NK). On a level with the osphradial structures, several nerves emanate from the dorsal surface of the visceral ganglion, the largest supplying posterior adductor muscle tissue (Fig. 3, NA). In the region of its association with the osphradium, the visceral ganglion has many neuronal soma. The axons of these soma may extend from the dorsal cortex of the ganglion across the central neuropil, into or through the ventral cortex of the ganglion and thence into the osphradial tissues.

Anterior and ventrolateral to the osphradial complex, a large extension of the visceral ganglion on each side closely adheres to the roof of the exhalant chamber, and rounds the ventral curve (Fig. 8, GRB) where the exhalant chamber roof becomes the floor of that chamber (also the roof of the branchial chamber, or the "diaphragm" of Ortmann, 1911). On each side this ganglionated extension gives rise to a branchial nerve. Each branchial nerve courses along the branchial shelf just under the shelf's simple epithelium and basement membrane, and just dorsal to a prominent longitudinal muscle. At the posterior end of the roof of the branchial chamber (also the floor of the exhalant chamber), each branchial nerve terminates in apparent junction with the aforementioned, cislateral, longitudinal muscle.

From the foregoing study it does not seem likely that the osphradia of *C. fluminea* function in regulation of gill cilia. It seems more likely that the osphradia are related to function of the posterior adductor muscle or to the kidney. Implications of these neuroanatomical observations will be considered further below.

#### DISCUSSION

This study shows that:

- 1) The osphradia of certain freshwater bivalves are located along with the visceral





FIG. 8. Photomicrograph of sagittal section of *Corbicula* cf. *C. fluminea*, showing the ganglionated root of a branchial nerve (GRB) as it enters the branchial shelf (diaphragm). Region shown is anterior to the visceral ganglion proper, and is some distance from the osphradium. Proximally (and dorsally) the branchial root is connected to the visceral ganglion. Distally (and ventrally) the ganglionated root becomes the branchial nerve which courses of the posterior end of the branchial shelf. Relate to location of right branchial nerve shown in Fig. 2.

ganglion with which they are closely associated, anteroventral to the posterior adductor muscle and within the membrane which forms the roof of the exhalant siphon. Thus it is fluid within the *exhalant* canal which moves freely over the highly innervated epithelial surface of the osphradia. This finding confirms anatomical relationships described earlier for *Corbicula* sp. (Kraemer, 1977).

2) The osphradia of these bivalves are paired, and extend on each side of the mid-ventral surface of the visceral ganglion laterally and anteriorly to terminate in a small projection of the exhalant chamber roof.

3) Each osphradium is a complex of three parts: (a) the osphradial epithelium, which lacks a basement membrane, and is comprised of small, abundantly innervated colum-

nar cells; (b) groups of nerve fibers immediately subjacent to the osphradial epithelium, with many fibrous connections ventrally to the osphradial epithelium and dorsally to the visceral ganglion; (c) several clusters of neuronal soma, some of which extend from the visceral ganglion proper into the tissue space between the visceral ganglion and the underlying osphradial epithelium, and some of which seem to be merely specialized regions of the visceral ganglion. Many of these neuronal soma have long processes which extend as nerve fibers among cells of the osphradial epithelium.

4) Examination of the neuroanatomical context of the osphradia indicates: (a) on a level with the osphradial structures, nerves emanate from the dorsal surface of the visceral ganglion to supply the posterior adductor muscle; (b) immediately anterior and medial to the osphradial structures, many tiny nerves extend from the visceral ganglion to the kidney; and (c) further anterior and laterally from the osphradial structures, a pair of large branchial nerves may be traced from their ganglionated bases at the visceral ganglion, into the roof of the inhalant chamber (also the floor of the exhalant chamber). Neuroanatomically the osphradia are therefore more closely associated with the posterior adductor muscle and even with the kidney than they are with branchial nerves.

Many of the above findings are summarized graphically in Fig. 3. Some of the histological findings seem generally to corroborate related findings in a marine bivalve *Mytilus edulis* (e.g. Lucas, 1931). Other results of the present study cast doubt on the hypothesis that bivalve osphradia are particle-size detectors related to nervous control of gill cilia (e.g. Aiello & Guideri, 1964).

In many gastropods, the osphradium is often located within the inhalant siphon, and is separated from the visceral ganglion by a distinct osphradial nerve and osphradial ganglion (e.g. Demal, 1955). By contrast, in the present study of bivalves, the paired osphradia are intimately associated with the anteroventral surface of the visceral ganglion itself. In evaluating the neuroanatomical context of these bivalve osphradia, it is apparent that the osphradia are much more closely associated with nerves innervating the posterior adductor muscle and the kidney than with branchial nerves. The branchial nerves in turn are closely associated with the visceral ganglion, both via ganglionated bases, and via tiny nerves emanating from the surface of the

visceral ganglion itself. The branchial nerves are not closely associated with the osphradia.

While various authors have proposed functions for bivalve osphradia (e.g. Yonge, 1947), the literature reviewed for this study offers no physiological evidence for a chemoreceptor or mechanoreceptor role for the bivalve osphradium. Aiello & Guideri (1964), who recorded changes in rate of beat of gill cilia in response to experimental stimulation of the visceral ganglion of *Mytilus edulis*, concluded that the osphradium was involved. They argued that Bailey & Laverack (1963) had recorded impulses from the branchial nerve of a gastropod in apparent response to stimulation of its osphradium. Aiello & Guideri erred. Bailey & Laverack recorded impulses from the visceral ganglion, not from the branchial nerve.

While a few authors have correctly described the general location of these organs within the exhalant chamber (e.g. Yonge, 1947; Charles, 1966), many others have not. It may be that a simple, but repeated error can account for the inchoate state of literature on bivalve osphradia. Frequent citations of certain studies of bivalve osphradia (e.g. Dakin, 1910; Stork, 1934), have perpetuated a misrepresentation of bivalve osphradia which views the osphradia as inverted from their actual position. It seems likely that this error stems from an effort by early workers to homologize bivalve osphradia with those of gastropods. The error is serious, because it has accompanied the assumption (implicit in many of the histological and physiological studies to date), that the bivalve osphradia are associated with the roof of the inhalant chamber, and thus with the incurrent or branchial siphon. As shown above (Figs. 1, 3), the bivalve osphradia are actually associated with the roof on the exhalant chamber.

Finally, it seems that new hypotheses are needed regarding the function(s) of the bivalve osphradia. New hypotheses should incorporate information presented here concerning the precise anatomical site, histological organization, accurate three-dimensional structure and neuro-anatomical context of these paired organs. New hypotheses might consider the possibility that bivalve osphradia are anatomically more suited to being "eyes" than a "nose." This is not a fanciful suggestion. With its location deep within the animal, its very intimate association with the largest ganglion and with its thickly innervated epithelium, I think a bivalve osphradium histologically resembles the pineal gland of the

vertebrate brain. Zoologists are generally well aware of light as an environmental stimulus to the pineal gland which enables migratory birds to respond with behavioral changes, for example, In bivalve mollusks an analogous phenomenon may occur. Elvin (1978: 646) noted that in certain intertidal mussels "... light reaching the mantle cavity . . . (was) found to be predominantly of long wavelength. . . . (There is) a positive correlation between thermal shocks enhanced by light, disappearance of neurosecretory material, and the release of oocytes." Might it be that the extensively innervated epithelium of the osphradium is a light sensor which functions in the regulation of seasonal behavior (e.g. Kraemer, 1970, on three species of *Lampsilis*) or reproductive physiology of the bivalve? (Regarding the latter, histological and neuroanatomical details of the hermaphroditic process in *C. fluminea* have been worked out by Kraemer, 1978).

The new hypotheses might also incorporate the possibility that functional links to kidneys and to adductor muscles may implicate the bivalve osphradia not only in control of fluid movement through the exhalant chamber, but also in adduction of the shell valves.

#### ACKNOWLEDGEMENTS

Thanks are due to Profs. C. M. Yonge, George M. Davis and Carol C. Jones, who critically reviewed the manuscript, and to Prof. Eric Russert Kraemer who contributed helpful suggestions in the revision of the manuscript. I thank Frances Waite for her skillful drawing of the *Lampsilis* dissection in Fig. 2, and James Hawkins for his expert assistance in the drafting of Figs. 1, 3, 4C and 6B.

#### LITERATURE CITED

- AIELLO, E. L., 1960, Factors affecting ciliary activity on the gill of the mussel *Mytilus edulis*. *Physiological Zoology*, 33: 120-135.
- AIELLO, E. L. & GUIDERI, G., 1964, Nervous control of ciliary activity. *Science*, 146: 1692-1693.
- ALEXANDER, C. G. & WELDON, M. W., 1975, The fine structure of the osphradial leaflets in *Conus flavidus*. *Marine Biology*, 33: 247-254.
- ANDERSON, E., 1963, Cellular and subcellular organization of the osphradium of *Busycon*. *Proceedings of the Sixteenth International Congress of Zoology*, 2: 280 (abstract).
- BAILEY, D. F. & BENJAMIN, P. R., 1968, Anatomical and electrophysiological studies on the gastropod osphradium. *Symposium of the Zoological Society of London*, 23: 263-268.

- BAILEY, D. F. & LAVERACK, M. F., 1963, Central nervous responses to chemical stimulation of a gastropod osphradium. *Nature*, 200: 1122–1223.
- BAILEY, D. F. & LAVERACK, M. F., 1966, Aspects of the neurophysiology of *Buccinum undatum* L. (Gastropoda). I. Central responses to stimulation of the osphradium. *Journal of Experimental Biology*, 44: 131–148.
- BAUMGARTEN, R. VON, JAHAN-PARWAR, B. & SMITH, M., 1968, Effect of olfactory and osmotic stimulation of the osphradium on neurosecretory nerve cells in *Aplysia*. *Mental Health Research Institute (University of Michigan), Annual Report*, 1968: 20–21.
- BAYNE, B. L., WIDDOWS, J. & THOMPSON, R. J., 1976, Physiology II. In BAYNE, B. L. (ed.), *Marine Mussels: Their Ecology and Physiology*. Cambridge University Press, New York, p. 207–260.
- BENJAMIN, P. R., 1971, On the structure of the pulmonate osphradium. Part 2. Ultrastructure. *Zeitschrift für Zellforschung und mikroskopische Anatomie*, 118: 168–189.
- BROWN, A. C. & NOBLE, R. G., 1960, Function of the osphradium in *Bullia* (Gastropoda). *Nature*, 188: 1045.
- BULBRING, E., BURN, J. H. & SHELLE, H. J., 1953, Acetylcholine and ciliary movement in the gill plates of *Mytilus edulis*. *Proceedings of the Royal Society of London*, ser. B, 141: 445.
- BULLOCK, T. G. & HORRIDGE, G. A., 1965, *Structure and Function in the Nervous Systems of Invertebrates*, II. Freeman, San Francisco and London.
- CARR, W. E. S., 1967, Chemoreception in the snail *Nassarius*. *Biological Bulletin*, 133: 90–127.
- CHARLES, G. H., 1966, Sense organs (less Cephalopoda). In WILBUR, K. L. & YONGE, C. M. (eds.), *Physiology of Mollusca*, II. Academic Press, New York, p. 455–521.
- CRISP, M., 1973, Fine structure of some prosobranch osphradia. *Marine Biology*, 22: 231–240.
- DAKIN, W. J., 1910, The visceral ganglion of *Pecten*, with some notes on the physiology of the nervous system and an inquiry into the innervation of the osphradium in the Lamellibranchiata. *Mitteilungen aus der Zoologische Station zu Neapel*, 20: 1–40.
- DAKIN, W. J., 1928, The anatomy and phylogeny of *Spondylus*, with a particular reference to the Lamellibranch nervous system. *Proceedings of the Royal Society of London*, ser. B, 103: 337–354.
- DEMAL, J., 1955, Essai d'histologie comparée des organes chémorécepteurs des gastéropodes. *Mémoires de l'Académie Royale de Médecine de Belgique*, 29: 1–82.
- ELVIN, D. W., 1978, Environmental and internal control of oogenesis in *Mytilus*. *American Zoologist*, 18: 646 (abstract).
- FREIDENFELT, T., 1904, Über den feineren Bau des Visceral Ganglions von *Anodonta*. *Acta Universitatis Lundensis Sectio II Medica Mathematica Scientiae Rerum Naturalium* 2, 40(5): 1–28.
- GOSSELIN, R. E., MOORE, K. E. & MILTON, A. S., 1962, Physiological control of molluscan gill cilia by 5-hydroxytryptamine. *Journal of General Physiology*, 46: 277.
- GRAVE, C. & SCHMITT, F. O., 1925, A mechanism for the coordination and regulation of ciliary movement as revealed by microdissection and cytological studies of ciliated cells of mollusks. *Journal of Morphology*, 40: 479–510.
- HYMAN, L. H., 1967, *The Invertebrates: Mollusca I*. McGraw-Hill, New York.
- JAHAN-PARWAR, B., VON BAUMGARTEN, R., HUKUHARA, T. & SMITH, M., 1968, Effects of osmotic stimulation of the osphradium upon the activity of neurosecretory cells in the abdominal ganglion of *Aplysia californica*. *Proceedings of the International Union of Physiological Sciences*, 7(24): 214 (abstract).
- JAHAN-PARWAR, B., SMITH, M. & VON BAUMGARTEN, R., 1969, Activation of neurosecretory cells in *Aplysia* by osphradial stimulation of seaweed oyster shrimp. *American Journal of Physiology*, 216(5): 1246–1257.
- KAMARDIN, N. N., 1976, Response of osphradium of mollusk *Lymnaea stagnalis* to different oxygen concentrations in water. *Journal of Evolutionary and Biochemical Physiology*, 12(5): 427–428. (English translation of *Zhurnal Evolyutsonnoi Biokhimii i Fiziologii*).
- KOHN, A. J., 1961, Chemoreception in gastropod molluscs. *American Zoologist*, 1: 291–308.
- KRAEMER, L. R., 1970, The mantle flap in three species of *Lampsilis* (Pelecypoda: Unionidae). *Malacologia*, 10: 225–282.
- KRAEMER, L. R., 1977, Aspects of the functional morphology of the mantle/shell and mantle/gill complex of *Corbicula* (Bivalvia: Sphaeriacea: Corbiculidae). *Bulletin of the American Malacological Union*, 1977: 25–31.
- KRAEMER, L. R., 1978, *Corbicula fluminea* (Bivalvia: Sphaeriacea): the functional morphology of its hermaphroditism. *Bulletin of the American Malacological Union*, 1978: 40–49.
- LANKESTER, R., 1883, Mollusca. In *Encyclopaedia Britannica XVI* (9th edition). Scribners and Sons, New York.
- LUCAS, A. M., 1931, The distribution of the branchial nerve in *Mytilus edulis* and its relation to the problem of nervous control of ciliary activity. *Journal of Morphology*, 51: 195–205.
- MICHELSON, E. H., 1960, Chemoreception in the snail, *Australorbis glabratus*. *American Journal of Tropical Medicine and Hygiene*, 9: 480–487.
- NEWELL, P. F. & BROWN, A. C., 1977, The fine structure of the osphradium of *Bullia digitalis* (Gastropoda: Prosobranchia). *Malacologia* 16: 197–205.
- ORTMANN, A. E., 1911, Monograph of the naiades of Pennsylvania. *Memoirs of the Carnegie Museum*, 8: 1–347.
- PENNAK, R. W., 1964, *Collegiate Dictionary of Zoology*. Ronald Press, New York.
- PHILLIPS, D. W., 1975, Localization and electrical activity of the distance chemoreceptors that mediated predator avoidance behavior in

- Acmaea limatula* and *Acmaea scutum* (Gastropoda: Prosobranchia). *Journal of Experimental Biology*, 63: 403–412.
- SCHMITZ, E. H., 1967, Visceral anatomy of *Gammarus lacustris* Sars (Crustacea: Amphipoda). *American Midland Naturalist*, 78: 1–54.
- SETNA, S. B., 1930, The neuro-muscular mechanism of the gill of *Pecten*. *Quarterly Journal of Microscopical Science*, 73: 365–391.
- SIMPSON, L., 1971, Light and electron microscopic structure of the osphradium in the pulmonate gastropod, *Helisoma*. *American Zoologist*, 11: 697 (abstract).
- SOKOLOV, V. A. & KAMARDIN, N. N., 1977, The relation of impulse frequency in the osphradial nerve to the concentration of oxygen and inulin in liquid passing over the osphradium of the pond snail. Leningrad University, Leningrad, USSR. *Vestnik Leningradskogo Universiteta Biologie, Biologii Geografii i Geologii* (1). 1977: 87–90.
- STINNAKRE, J. & TAUC, L., 1969, Central neuronal response to the activation of osmoreceptors in the osphradium of *Aplysia*. *Journal of Experimental Biology*, 51: 347–361.
- STORK, H. A., 1934, Beiträge zur Histologie und Morphologie des Osphradiums. *Archives Néerlandaises de Zoologie*, 1: 71–99.
- TOWNSEND, C. R., 1973, The role of the osphradium in chemoreception by the snail *Biomphalaria glabrata*. *Animal Behaviour*, 21:549–556.
- YONGE, C. M., 1947, The pallial organs in the Aspidobranch Gastropoda and their evolution throughout the Mollusca. *Philosophical Transactions of the Royal Society of London*, B, 232: 443–578.

## GENETIC RELATIONSHIPS AMONG RECENT UNIONACEA (BIVALVIA) OF NORTH AMERICA<sup>1</sup>

George M. Davis and Samuel L. H. Fuller

*Academy of Natural Sciences of Philadelphia,  
Nineteenth and the Parkway, Philadelphia, PA 19103, U.S.A.*

### ABSTRACT

The purposes of this paper are to determine why there has been so little agreement among classifications of North American Unionacea, to test the Heard & Guckert (1971) assumptions that the number of marsupial demibranchs and length of breeding season serve to define higher taxa, to examine the congruency among major classifications of North American Unionacea, and to establish a classification resulting from a synthesis of data derived from molecular genetics, comparative anatomy, and zoogeography through time.

Immuno-electrophoretic studies of 52 species belonging to 27 genera were conducted. We scored the percent difference between pairs of taxa. Data were analyzed with multivariate techniques of the NT-SYS program. Emphasis was placed on results of multidimensional scaling, ordination, minimum spanning tree, and subsets.

On the basis of our results we determined that in the Nearctic Unionacea there are one family (Unionidae) and three, genetically very distinct subfamilies: Margaritiferinae, Anodontinae, and Ambleminae. The three subfamilies are clearly defined morphologically and immunologically. The Ambleminae are further divided into four tribes: Gonideini, Amblemini, Pleurobemini, Lampsilini. It is clear that both tetragenous and ectobranchous taxa have evolved in various clades. The ectobranchous genus *Elliptio* and tetragenous genus *Fusconaia* are closely related in the Pleurobemini, the ectobranchous genus *Cyclonaias* and tetragenous genus *Quadrula* are closely related in the Amblemini, and the tetragenous *Gonidea* is more closely related to the Lampsilini (which are ectobranchous) than to the Pleurobemini or Amblemini. The ectobranchous state has undergone parallel evolution, as have different lengths of breeding season.

Our classification and that of Ortmann (1910a) have the greatest congruence. We consider these classifications to reflect real clades more closely than other systems do, because both are based on all of the data available. We consider the other classifications to be artificial in that they are based on conchology alone or on the unjustified weighting of one or two key characters. We differ from Ortmann and all previous workers in establishing the Anodontinae as a taxon of equal standing with the Margaritiferinae as a second group and with all other North American Unionidae in the Ambleminae as a third.

### INTRODUCTION

North American unionacean bivalves (unios, freshwater mussels, naiades) comprise one of the most diverse radiations of macroinvertebrates seen today in fresh water. There are about 50 nominal genera, which include over 225 species and subspecies (Heard & Guckert, 1971; Burch, 1973, 1975). Unios have dominated streambeds in terms of biomass and numbers of individuals, but decreasingly in this century. Centers of endemism and high species diversity are found in the eastern United States, e.g. the Ohio, Tennessee and Coosa-Alabama river drainages. Numbers of sympatric species literally paved

the large-river shoals in the early 19th century. For example, Conrad (1834) reported the richest of all known localities, a section of the Tennessee River that later became known as Mussel Shoals. The shoals contained some 70 species packed valve to valve.

Even though the diversity and abundance of the unionid fauna stimulated a more than 80 year continuous outflow of systematic and taxonomic literature concerned with higher-category relationships among unionids (review by Heard & Guckert, 1971), there is little agreement among classifications today. Disparity among major classifications (reviewed in Appendix 1) seems to occur because 1) different sets of characters were used by dif-

<sup>1</sup>This work was supported by National Science Foundation grant DEB 78-01550.

ferent investigators; 2) a monothetic basis for classification was used by some; 3) there is the high probability that one or more "key" character-states has undergone parallel or convergent evolution, and 4) too few morphological characters with unique character-states exist (or have been found) that would enable a satisfactory comparison of taxa.

Classifications based primarily on shell characters persist to the present (Frierson, 1927; Modell, 1942, 1949, 1964; Haas, 1969 a, b). Some early classifications were based on additional characters of the soft parts, e.g. gill structure, marsupium, and glochidia (Simpson, 1896, 1900, 1914; Sterki, 1898, 1903). Ortmann (1910a, 1911, 1912b, 1916) extended the work of Simpson and Sterki by increasing the number of characters derived from soft-part morphology and integrated all available morphological data (i.e. on shell and soft parts). Use of shell characters for classification above the species level eventually was rejected. Hannibal (1912) stated that shell characters were of no use in establishing taxa above the generic level. Hannibal was followed by Heard & Guckert (1971), who stated: "... we have subjectively elected to ignore one entire array of characters (i.e., conchological features) and to suggest soft-part anatomy and reproductive habits as pre-eminent in describing phylogenies."

Heard & Guckert (1971) especially weighted two characters involving reproduction. These are the number of demibranchs used as the marsupium and the length of the breeding season. For example, they recognized two families, Amblemidae and Unionidae, on the basis that species with four marsupial demibranchs (tetrigenous) belong to the former family while those with only the outer two demibranchs marsupial (ectobranchous) belong in the latter family. They created sub-families on the basis of whether taxa are bradytictic (i.e. long-term breeders, retaining glochidia except in the Nearctic summer) or tachytictic (i.e. short-term breeders, retaining glochidia only in the Nearctic summer).

We initiated our work on higher-category relationships among North American unios in order to test the validity of the Heard & Guckert assumptions and classification. Because there is so little agreement among the major classifications, we suspected that one or more key character-states has undergone convergent or parallel evolution. We also suspected that one cannot excessively weight characters having to do with reproductive

strategies. For example, a strategy of bradytixis might occur again and again in different radiations of unionids. Likewise, the tetrigenous and ectobranchous conditions feasibly could occur in different radiations. We noted that brooding young in the pallial oviduct of mesogastropods has arisen independently in several families of different superfamilies (Fretter & Graham, 1962).

Our suspicions are not without basis. For example, *Fusconaia masoni* (Conrad) was placed in the genus *Elliptio* by Haas (1969a) and relegated to *Pleurobema* (*Lexingtonia*) by Johnson (1970). *Elliptio* and *Pleurobema* were considered Unionidae by Ortmann (1910a, 1911, 1912b, 1919) and Heard & Guckert (1971). However, *F. masoni* is tetrigenous and thus belongs to *Fusconaia* (Fuller, 1974). Except for the one character-state difference, one finds little difference between *F. masoni* and various species of *Elliptio* and *Pleurobema*. However, if the Heard & Guckert classification were followed, the species would have to be transferred from the ectobranchous Unionidae to the tetrigenous Amblemidae on the basis of that one character-state.

We further suspected that unionid species have too few unique morphological character-states to permit an adequate phenetic or cladistic analysis of relationships. We admit that there may be more morphological characters, but these have yet to be discovered. Such characters probably would have to be found by detailed comparative anatomical studies of internal organ systems. Because of the dearth of unique morphological character-states, we established a program to assess relationships on the basis of molecular genetics. In this paper we present a higher classification of North American Unionacea based on immunoelectrophoretic data and what morphological, paleontological, and zoogeographical data are available. In so doing, we assess not only the relationships among unionid taxa, but also the relative values of different approaches to unionacean taxonomy used to structure the various major classifications.

## MATERIALS AND METHODS

### Species studied

Fifty-two species, representing 27 genera, were studied (Table 1). These species were

TABLE 1. Fifty-two species of North American Unionacea alphabetized by the code designations used in this study. Localities are given with ANSP catalog numbers.

Code	Species	Locality	ANSP voucher no.
Ac	<i>Anodonta cataracta</i> (Say)	Gloucester Co., New Jersey	333526
Acr	<i>Actinonaias carinata</i> (Barnes)	Clark Co., Arkansas	341958
Ai	<i>Anodonta imbecillis</i> (Say)	Jenkins Co., Georgia	333563
Aip	<i>Anodonta implicata</i> (Say)	Hartford Co., Connecticut	334650
Ap	<i>Amblema perplicata</i> (Conrad)	Rapides Parish, Louisiana	334560
Apl	<i>Amblema plicata</i> (Say)	Clark Co., Arkansas	341939
Au	<i>Alasmidonta undulata</i> (Say)*	Hartford Co., Connecticut	334649
Aw	<i>Anodonta wahlametensis</i> (Lea)	Modoc Co., California	345880
Cp	<i>Carunculina parva</i> (Barnes)*	Rapides Parish, Louisiana	334564
Ct	<i>Cyclonaias tuberculata</i> (Raf.)*,+	Hancock Co., Tennessee	335048
Cu	<i>Cumberlandia monodonta</i> (Say)*,+	Hancock Co., Tennessee	341956
Eb	<i>Elliptio buckleyi</i> (Lea)	Putnam Co., Florida	334427
Ec	<i>E. complanata</i> (Lightfoot)	Gloucester Co., New Jersey	333527
Ec <sup>2</sup>	***	Sussex Co., New Jersey	334428
Ec <sup>3</sup>	***	Barnwell Co., South Carolina	333296
Ec <sup>4</sup>	***	Barnwell Co., South Carolina	—
Ec <sup>5</sup>	***	Wayne Co., Pennsylvania	339430
Ecr	<i>E. crassidens</i> (Lam.)*	Hancock Co., Tennessee	—
Ei	<i>E. icterina</i> (Conrad)	Jenkins Co., Georgia	333566
EI	<i>E. lanceolata</i> (Lea)	Jenkins Co., Georgia	333565
EI <sup>2</sup>	***	Barnwell Co., South Carolina	—
EI <sup>3</sup>	***	Jenkins Co., Georgia	—
Ew	<i>E. waccamawensis</i> (Lea)	Columbus Co., North Carolina	339967
Fbb	<i>Fusconaia cf. flava</i> (Raf.)	Rapides Parish, Louisiana	334563
Fe	<i>F. ebena</i> (Lea)	Greene Co., Alabama	340626
Ff	<i>F. flava</i> (Raf.)	Hancock Co., Tennessee	335049
Fm	<i>F. masoni</i> (Conrad)	Jenkins Co., Georgia	333564
Ga	<i>Gonidea angulata</i> (Lea)*,+	Modoc Co., California	339965
Gr	<i>Glebula rotundata</i> (Lam.)*,+	Rapides Parish, Louisiana	334556
Lc	<i>Lasmigona costata</i> (Raf.)*	Hancock Co., Tennessee	335047
Lcl	<i>Lampsilis claibornensis</i> (Lea)	Lowndes Co., Mississippi	—
Lf	<i>Leptodea fragilis</i> (Raf.)	Hancock Co., Tennessee	335046
Lh	<i>Lampsilis hydiana</i> (Lea)	Rapides Parish, Louisiana	334558
Ln	<i>Ligumia nasuta</i> (Say)	Burlington Co., New Jersey	334251
Lo	<i>Lampsilis ovata</i> (Say)*	Hancock Co., Tennessee	335029
Lr	<i>L. radiata</i> (Gmelin)	Sussex Co., Delaware	339342
Lre	<i>Ligumia recta</i> (Lam.)*	Clark Co., Arkansas	340628
Ls	<i>Lampsilis splendida</i> (Lea)	Barnwell Co., South Carolina	334432
Lt	<i>L. teres</i> (Raf.)	Rapides Parish, Louisiana	334557
Lv	<i>L. ventricosa</i> (Barnes)	Clark Co., Arkansas	—
Mf	<i>Margaritifera falcata</i> (Gould)	Oregon	339339
Mg	<i>Megalonaias gigantea</i> (Barnes)*	Rapides Parish, Louisiana	334553
Mh	<i>Margaritifera hembeli</i> (Gould)	Rapides Parish, Louisiana	334426
Mm	<i>M. margaritifera</i> (L.)*	Schuylkill Co., Pennsylvania	334867
Pa	<i>Proptera alata</i> (Say)*	Hancock Co., Tennessee	335040
Pc	<i>Pleurobema cordatum</i> (Raf.)	Clark Co., Arkansas	340629
Pd	<i>Plectomerus dombeyanus</i> (Val.)*,+	Rapides Parish, Louisiana	334555
Ppu	<i>Proptera purpurata</i> (Lam.)	Clark Co., Arkansas	390630
Ps	<i>Ptychobranhus subtentum</i> (Say)	Hancock Co., Tennessee	335045
Qa	<i>Quadrula apiculata</i> (Say)	Evangeline Parish, Louisiana	339670
Qbb	<i>Q. cf. quadrula</i> (Raf.)*	Rapides Parish, Louisiana	334562
Qc	<i>Q. cylindrica</i> (Say)**	Hancock Co., Tennessee	335041
Qi	<i>Quincuncina infucata</i> (Conrad)	Crawford Co., Georgia	334539
Qp	<i>Quadrula pustulosa</i> (Lea)	Clark Co., Arkansas	340946
Tv	<i>Tritogonia verrucosa</i> (Raf.)*,+	Rapides Parish, Louisiana	339671
Ut <sup>2</sup>	<i>Uniomerus tetralasmus</i> (Say)*	Rapides Parish, Louisiana	334561
Vd	<i>Villosa delumbis</i> (Conrad)	Jenkins Co., Georgia	333569
Vi	<i>V. iris</i> (Lea)	Hancock Co., Tennessee	335050

\* = type-species

\*\*type-species of *Orthonymus*

+ = monotypic genus

\*\*\*used for analysis of conspecific populations

chosen among all those collected from various localities across the country because they were representative of each of the families and subfamilies recognized by Ortmann (1910a, 1911, 1912b, 1916, 1919), Modell (1942, 1949, 1964), and Heard & Guckert (1971). We collected and chose type-species whenever possible. We were able to study 18 type-species of the 27 genera (66.7%). These are marked with an asterisk in Table 1. Shells of each population are maintained as voucher specimens in the Academy of Natural Sciences of Philadelphia (ANSP); catalog numbers and locality data are given in Table 1.

#### Preparation of antigens and antigen bank

Foot muscle and gravid gill were used as a source of proteins. Gravid gills were carefully inspected for the presence of unionicolid mites in order to ensure that antigen preparations were not contaminated with mite antigens. Tissues were pooled from 12 to 60 individuals according to their size. The gravid gill extract essentially equaled glochidial extract because gill filament tissue added very little in terms of protein mg in comparison to the yield from the glochidia. In preparing extracts, 300 mg blotted foot tissue (cleaned of gonad) were homogenized in 1.5 cc buffer. Homogenization was accomplished by first subjecting the mixtures to a Waring Blender for two minutes and then to sonication-homogenization (via a Polytron) for two minutes per 30 ml. The homogenate was centrifuged at  $6900 \times g$  for 20 minutes; the supernatant was lyophilized (1 ml per 2 ml ampule). All prelyophilization operations were carried out at 1–3°C.

In this manner 100 to 300 ampules of lyophilized extract from each population were prepared for storage in freezers (at  $-20^{\circ}\text{C}$ ). The protein content of each lyophilized batch was determined by the folin reagent test (Daughady et al., 1952).

#### Antisera

Two rabbits (New Zealand white, virgin, female, 7–8 lbs) initially were used per mussel population. Lyophilized antigens were reconstituted with normal saline and injected subcutaneously with an equal volume of Freund's complete adjuvant. There were two injection series (days 1, 3, 5, and 7; rest 3 weeks; repeat the series). Each injection contained 2 mg protein. We bled out the rabbits by heart puncture 4 days after the last injection.

**Titre and Serum Quality**—Antiserum quality was tested by immunoelectrophoresis (see below). Sera were kept and used in experiments if 10 or more precipitin arcs resulted in the homologous reaction. If an antiserum was discarded for producing too few antigen-antibody precipitin systems, two or more rabbits were used to produce specific antisera.

**Controls**—Each rabbit was bled from the ear prior to the first injection with antigen; the serum was tested for reactivity to molluscan antigen.

**Absorption**—An antiserum was absorbed with a heterologous antigen by adding 0.8 ml antiserum to an ampule of lyophilized antigen, swirling, leaving at room temperature for 30 minutes, refrigerating for 30 minutes, and centrifuging for 20 minutes ( $6900 \times g$ ).

**Immunoelectrophoresis**—The procedures used are those of Davis (1969) and Davis & Suzuki (1971), with some adjustments. The 2% agar noble contained 0.45% NaCl, 1:10,000 merthiolate, and half-strength barbital-acetate buffer of pH 8.2. Full-strength buffer contained 5.4 g Na-barbital, 4.3 g sodium acetate, and 58.2 ml 0.1 N HCl per liter.

Protein concentrations of antigens were adjusted to 6 mg/ml. Direct current of 6–8 v/cm across the slides was sustained for one hour.

#### Analysis of immunological data

Twelve slides were used in each experiment, of which two were controls, i.e. the homologous system with unabsorbed serum. We determined the number and position of each precipitin arc by comparing the experimental slides with control slides. In each experiment we absorbed the serum of the reference population (homologous system) with a heterologous antigen so that there were five sets of absorbed sera. The two wells punched in the agar on each slide were loaded with homologous and heterologous antigens, respectively. Absorbed antisera were used in the slots of the 10 non-control slides. Lack of arcs between the slots and the wells with the heterologous antigens indicated complete absorption. The number of arcs between the slot and the well with the homologous antigens indicated the number of antigens unique to the reference species. The position of the arc identified the antigen.

We scored the percent difference between taxa. The average number of precipitin arcs was 12 with a range of 10 to 14. We analyzed



TABLE 2. Matrix giving the average percent difference of antigens in cross comparison of 14 taxa (14 sets of antigens  $\times$  14 sets of antisera).

	1	2	3	4	5	6	7	8	9	10	11	12	13	14
<i>Margaritifera falcata</i>	0													
<i>M. hembeli</i>	30.5	0												
<i>M. margaritifera</i>	34.0	33.0	0											
<i>Cumberlandia monodonta</i>	39.0	24.5	20.5	0										
<i>Quadrula cylindrica</i>	61.0	41.5	45.0	50.0	0									
<i>Fusconaia flava</i>	58.0	36.5	56.0	40.5	35.0	0								
<i>F. masoni</i>	58.5	47.5	47.5	55.5	42.5	17.5	0							
<i>Quadrula quadrula</i>	64.5	49.5	66.5	45.5	14.0	22.5	21.5	0						
<i>Megaloniaias gigantea</i>	52.0	43.5	66.5	50.0	22.5	29.5	13.0	20.5	0					
<i>Cycloniaias tuberculata</i>	65.0	41.5	54.0	58.0	23.0	22.5	26.5	12.0	16.0	0				
<i>Elliptio buckleyi</i>	63.0	47.5	60.5	60.5	37.5	26.5	27.0	26.5	26.5	34.5	0			
<i>Proptera alata</i>	61.5	45.5	50.0	45.5	30.0	31.5	25.5	35.5	31.5	31.5	28.5	0		
<i>Villosa delumbis</i>	61.0	50.0	45.5	56.5	27.5	32.5	36.5	33.3	37.5	29.0	45.5	32.5	0	
<i>Anodonta cataracta</i>	62.0	50.0	67.5	54.0	40.0	46.5	47.0	40.0	49.0	40.5	37.5	45.0	37.5	0

TABLE 3. Raw data (percent difference) for 21 antisera and 52 species (antigens). Key to abbreviations is given in Table 1. NC = no data available.

Species	Antisera																				
	1 Ac	2 Au	3 Ct	4 Cu	5 Eb	6 Ec <sup>2</sup>	7 Ecr	8 Ei	9 Fbb	10 Fm	11 Ga	12 Lo	13 Mg	14 Mh	15 Mf	16 Mm	17 Pa	18 Qbb	19 Qc	20 Tv	21 U <sup>2</sup>
Mf	70	56	58	33	63	50	50	56	53	45	70	75	41	25	0	50	50	66	50	50	50
Mm	60	50	58	25	63	41	56	50	46	45	50	60	75	0	36	0	41	58	50	50	58
Mh	50	56	50	33	45	50	50	41	40	54	50	56	66	0	36	33	41	58	50	50	58
Cu	50	56	58	0	63	41	50	50	40	45	70	64	50	16	45	16	41	50	50	56	50
Ga	50	50	41	58	NC	25	41	50	33	27	0	41	41	50	63	75	33	50	40	41	33
Ap	40	41	33	41	18	25	25	25	26	18	30	50	16	33	63	50	16	33	30	16	16
Fe	50	50	50	66	36	50	33	25	40	27	50	50	41	50	81	58	33	41	40	16	41
Ff	50	50	25	58	18	16	33	16	33	9	50	41	25	41	72	41	33	33	30	25	41
Fbb	40	41	25	41	27	25	50	16	0	9	40	41	33	33	63	66	25	25	30	41	33
Fm	40	41	25	66	36	33	41	16	27	0	50	41	8	41	72	50	33	16	40	25	41
Qbb	30	41	8	41	27	25	41	16	20	27	50	41	16	41	63	48	25	0	20	16	33
Qa	30	50	8	66	36	33	50	41	33	27	50	41	25	50	72	58	25	16	10	33	25
Qc	40	50	16	50	45	25	41	25	20	45	40	41	25	33	63	50	25	8	0	16	41
Pd	40	56	16	50	27	16	41	25	33	27	40	41	8	41	63	58	16	25	20	25	33
Qi	40	NC	16	58	36	NC	NC	NC	33	27	NC	NC	41	41	NC	58	25	16	30	NC	NC
Tv	40	50	25	58	27	41	50	25	40	45	40	50	41	41	90	50	33	25	20	0	41
Mg	40	56	16	50	27	16	50	33	26	18	50	41	0	41	63	48	25	25	20	25	41
Ct	40	50	0	58	36	16	41	25	20	27	30	41	16	33	72	48	25	16	30	25	25
Ec	50	41	25	41	18	0	33	8	20	9	30	50	25	33	63	33	25	25	20	16	41
Ei	40	50	25	66	18	16	33	0	25	27	40	50	50	50	72	58	25	33	30	33	41
Ei	40	50	16	50	0	16	33	8	33	18	30	50	41	41	63	75	25	33	30	16	41
Ew	50	50	41	66	18	8	33	25	33	18	50	50	41	50	63	66	33	50	40	25	41
Ecr	40	41	16	41	27	16	0	8	33	27	50	41	33	41	54	58	25	33	20	33	41

Ut	40	41	25	50	45	33	16	41	26	27	20	41	33	50	72	58	25	10	25	0
Pc	50	41	33	50	NC	16	16	25	20	0	40	56	33	41	72	50	16	30	33	41
Cp	30	41	33	50	45	25	41	33	33	36	30	41	50	50	63	41	25	30	41	41
Gr	30	56	33	50	18	25	41	33	26	36	50	33	33	50	63	50	25	30	33	33
Lt	40	41	33	50	27	33	41	41	46	45	40	41	41	50	63	50	41	30	41	41
Lcl	40	50	41	75	36	33	33	33	33	27	50	25	58	50	72	66	33	40	25	41
Ls	40	33	41	58	36	41	33	16	26	36	50	16	41	41	81	50	33	40	33	16
Lo	40	50	33	50	27	41	41	33	33	36	40	0	33	41	81	50	41	40	33	41
Lh	40	50	33	58	36	16	33	16	26	36	30	25	41	50	72	58	25	30	41	41
Lf	40	41	25	50	27	25	25	NC	46	27	40	16	45	41	72	41	25	30	25	NC
Lr	50	56	41	58	NC	41	41	25	40	36	50	25	41	41	63	66	33	30	41	41
Ln	30	50	25	58	36	33	25	33	26	45	30	33	33	41	72	41	25	30	33	41
Pa	40	41	33	41	27	33	25	25	33	18	40	41	33	41	63	50	41	30	41	41
Ppu	50	50	41	50	NC	25	41	33	46	45	50	33	33	50	72	50	8	40	33	41
Vd	50	50	33	66	54	33	41	41	40	36	60	16	50	50	72	66	40	30	33	NC
Vi	40	NC	33	33	45	NC	NC	NC	33	27	NC	NC	41	33	72	50	40	30	33	NC
Ps	50	50	33	50	36	25	33	33	40	27	50	33	33	41	63	50	40	30	33	41
Eb	30	41	33	58	0	25	NC	NC	26	18	30	50	25	50	63	58	25	30	NC	NC
Ac	0	33	41	58	45	50	50	41	53	54	50	50	58	50	54	75	41	50	50	50
Ai	20	16	58	50	54	50	50	56	60	45	50	56	50	58	63	66	41	50	50	66
Aip	20	8	41	66	45	41	33	41	46	45	60	50	50	41	63	66	33	50	56	41
Au	20	0	41	50	45	50	33	56	40	45	60	56	58	50	72	58	41	50	50	41
Lc	20	33	50	50	45	50	33	50	46	63	60	50	41	41	72	50	33	60	50	50
Aw	40	41	58	50	NC	50	50	56	46	45	70	60	50	50	63	66	50	50	56	50
Lre	60	60	33	50	NC	33	25	41	46	45	40	33	41	50	63	58	25	40	41	41
Acr	50	56	33	50	NC	16	41	16	33	36	40	16	41	50	63	58	8	30	41	41
Qp	50	50	25	50	NC	25	50	33	33	36	40	50	27	41	72	50	33	20	16	33
Apl	50	41	16	50	NC	8	33	16	33	0	NC	41	8	41	62	59	25	10	16	16
Lv	50	50	50	50	NC	33	25	33	46	45	40	16	41	50	81	58	41	40	41	41

the relationships among taxa by using multivariate analysis. Computations were made using the NT-SYS program (Rohlf et al., 1972) at the Uni-Coll Corporation, Philadelphia, or via a remote job-entry station to the Sun Oil Corporation Computer (IBM 370/168 VS2). Initially, three types of matrices were used: 1) the Mainardi (1959) immunological distance was used as a distance coefficient, 2) the distance between taxa was used as a distance coefficient (Table 2), and 3) and OTU  $\times$  antiserum matrix was made where the 52 OTUs were antigens (i.e. species or populations of a given species) and the 21 antisera were treated as characters (Bashford et al., 1968). The percent arcs unique to the homologous system = percent difference that was used as a distance coefficient (Table 3). In the first two matrices, comparisons were made where there was an antiserum for each species.

In the analysis we standardized by rows (antisera) in order to produce a matrix of transformed distance coefficients. We employed the minimum spanning tree (MST) and "subsets" components. Character correlations were subjected to Principal Component Analysis (PCA) with components extracted until eigen-values became less than 1.0. A transposed matrix of the first three PCs with their character loading was post-multiplied by the standardized matrix in order to yield a matrix of OTU projections in the PCA space (Rohlf et al., 1972). The resulting PCA-based configuration portrays distance-ordered relationships well, but tends to distort close-relative relationships, which often are of critical interest to taxonomists (Rohlf, 1970; Webster, 1975). OTU locations in the 3-

dimensioned PCA space were used as the initial configuration for a nonmetric multidimensional scaling (MDS) placement of taxonomic distances between OTUs (Kruskal, 1964). OTU configurations were adjusted after scaling by PCA analysis on a variance-covariance matrix obtained from the MDS-coordinates in order to realign the major trends of the variation in the reduced configuration space with the coordinate axes, while maintaining the accuracy of between-OTU distances in the ordination space (Rohlf et al., 1972). Distances between OTUs in the PCA- and MDS-spaces were found and compared with the matrix (cophenetic) correlation coefficient.

We placed no reliance on cluster analysis and phenograms to illustrate relationships. We emphasized ordination and MDS that are freed from the constraints of phenogram construction.

#### Comparison of taxa

Experiments were conducted by using foot muscle antigens in order to determine to what extent we could find differences between unionids and non-unionacean clams and between different conspecific populations of the same species. Results would be important bench marks for assessing differences between species. We also compared different populations of the same species by using glochidial antigens.

We compared three species of unionids with three species of marine bivalves by using the foot-muscle system. The comparisons involved four different taxonomic orders (Table 4).

TABLE 4. Classification according to Morton (1971) of marine species compared with the unionacean species used to test immunological congruity on the basis of foot-mussel antigens.

---

Class Bivalvia
Order: Anisomyaria
Superfamily: Mytilacea
Genus and species: <i>Geukensia demissa</i> (Dillwyn)
Order: Schizodonta
Superfamily: Unionacea
Genus and species: <i>Anodonta cataracta</i> Say
<i>Elliptio complanata</i> (Lightfoot)
<i>Elliptio icterina</i> (Conrad)
Order: Heterodonta
Superfamily: Veneracea
Genus and species: <i>Mercenaria mercenaria</i> (Linné)
Order: Adapedonta
Superfamily: Myacea
Genus and species: <i>Mya arenaria</i> Linné

---

## Annotations and terminology

Annotations, indicated by superscript number with a taxon, are given in numerical order in Appendix 2. Definitions of terms concerning breeding season and marsupial conditions are given in Appendix 3.

## RESULTS

## Comparison of unionids with marine species

As is seen in Table 5, only one or two antigens were shared in common by unionids and

TABLE 5. Congruity of marine and unionid species in percentage differences.

Marine species	Antisera		
	Ac <sup>2</sup> (10)	Ec (12)	Ei (12)
<i>Mercenaria mercenaria</i>	80	92	84
<i>Geukensia demissa</i>	80	92	92
<i>Mya arenaria</i>	80	92	92

( ) , number of precipitin arcs. Coded names given in Table 1.

TABLE 6. Comparison of different populations of the same species on the basis of glochidial and foot-muscle antigen-antisera systems. Percentage difference is given.

Gravid Gill			
Populations	Antisera		
	Ec <sup>2</sup> (12)	Ei (14)	
Ec <sup>3*</sup>	33	—	
Ei <sup>2</sup>	—	21	
Ei <sup>3</sup>	—	14	
Foot-Muscle			
Populations	Antisera		
	Ec <sup>2</sup> (12)	Ac <sup>2</sup> (10)	Ei (12)
Ec	0	—	—
Ec <sup>3</sup>	0	—	—
Ec <sup>4</sup>	0	—	—
Ec <sup>5</sup>	0	—	—
Ac	—	0	—
Ei <sup>2</sup>	—	—	0
Ei <sup>3</sup>	—	—	0

( ) number of precipitin arcs.

\*coded names given in Table 1.

species of other bivalve orders. Accordingly, the immunological comparisons among unionid taxa involve antigens that are primarily (> 85%) unique to the Unionidae.

## Comparisons among populations of the same species

It was possible to demonstrate 14% to 33% difference among populations of the same species by using glochidial antigen-antibody systems; it was not possible to discriminate among populations of the same species by using foot-muscle systems (Table 6). Because the foot-muscle systems were the more conservative, investigations reported here were based on foot-muscle systems. Differences among taxa are differences above the conspecific population level.

## Comparing species by using foot-muscle antigens

An initial multivariate assessment was made where a comparison involving an antiserum for each species was possible. This initial comparison involved 14 species. We used the Mainardi (1959) immunological distance and the average percent difference as distance coefficients. We abandoned use of the Mainardi distance coefficient because the results of ordination by using this distance were more distorted ( $r = 0.809$ ) than results with the average distance (Table 2,  $r = 0.922$ ). The results of ordination based on the average distance and the first two principal components are given in Fig. 1. The first two components accounted for 89.50% of the data. The correlation between the matrix of taxonomic distances and distances in the 3-dimensional MDS was excellent, i.e., 0.922; the stress was 0.213.

As can be seen from Fig. 1, there are three widely separated groups of taxa: 1) species considered on classical grounds to be Margaritiferidae (i.e., species of the nominal genera *Margaritifera* and *Cumberlandia*), 2) the single species of *Anodonta*, and 3) the cluster including *Elliptio*, *Fusconaia*, *Megaloniaias*, *Proptera*, *Quadrula*, and *Villosa*. *C. monodonta* and *Margaritifera margaritifera* are in the same set; *Cycloniaias tuberculata* and *Quadrula* cf. *Q. quadrula* are in a set and more closely allied to each other than either is to *Q. cylindrica*. *Megaloniaias gigantea* and *F. masoni* are in a set. *Elliptio* and *Fusconaia* are closely associated.

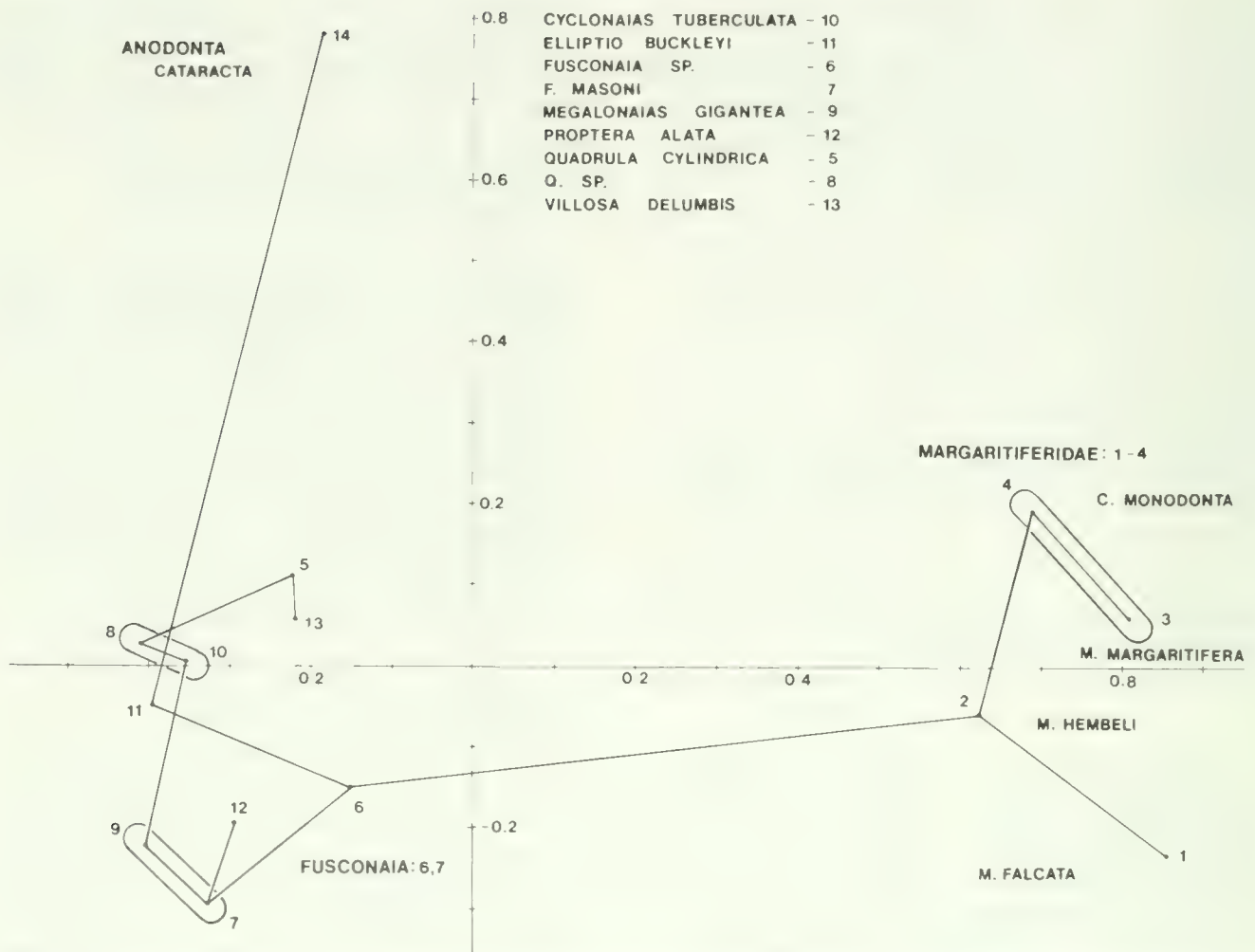

FIG. 1. Ordination diagram in two dimensions showing relationships among 14 taxa via use of the minimum spanning tree and subsets. The data are based on cross comparisons using 14 sets of antisera and antigens. See text for details.

Results of comparing 52 OTUs  $\times$  21 antisera are shown in Fig. 2. The ordination involving the first two principal components accounted for 92.84 percent of the data. The correlation between the matrix of taxonomic distances and distances in the 2-dimensional MDS was excellent, i.e., 0.946; the stress was 0.205.

We again found three widely separated groups of species. These groups are essentially those seen in Fig. 2: 1) the *Margaritifera* group (quadrant I), 2) the *Anodonta* group (quadrant IV), and 3) a large mass of taxa linked together primarily in quadrants II and III.

A series of subsets encloses the species in the *Margaritifera* cluster. *Cumberlandia monodonta* is in a subset with *M. hembeli*; those two are in a large set with *M. margaritifera*. All four species are clustered in an inclusive set. In the *Anodonta* cluster *A. cataracta* is in a subset with *A. imbecillis*. *A. implicata* is in another subset with *Lasmigona costata*.

Because so many taxa are grouped in the third cluster and because this cluster is so distinct from the *Anodonta* and *Margaritifera* groups, we did a multivariate analysis of only those species and corresponding antisera from that third cluster. This involved a subset of the database (Table 7) of 15 antisera and 40 OTUs. We omitted data for *Quincuncina infucata* because we had too few data for this comparison. In this reduced set there were only 19 comparisons of 600 for which we had no data. The results of ordination involving the first two principal components are shown in Fig. 3. Only 78.97 percent of the data are represented. The correlation between the matrix of taxonomic distances and distances in the 3-dimensional matrix was 0.913; the stress was 0.378.

Three closely allied clusters are seen (Fig. 3) in quadrants I, II-III, and IV. Genera within these clusters are listed in Table 8. Two of the genera are found in two clusters: *Amblema* and *Fusconaia*. *A. plicata* is in cluster 1; *A.*

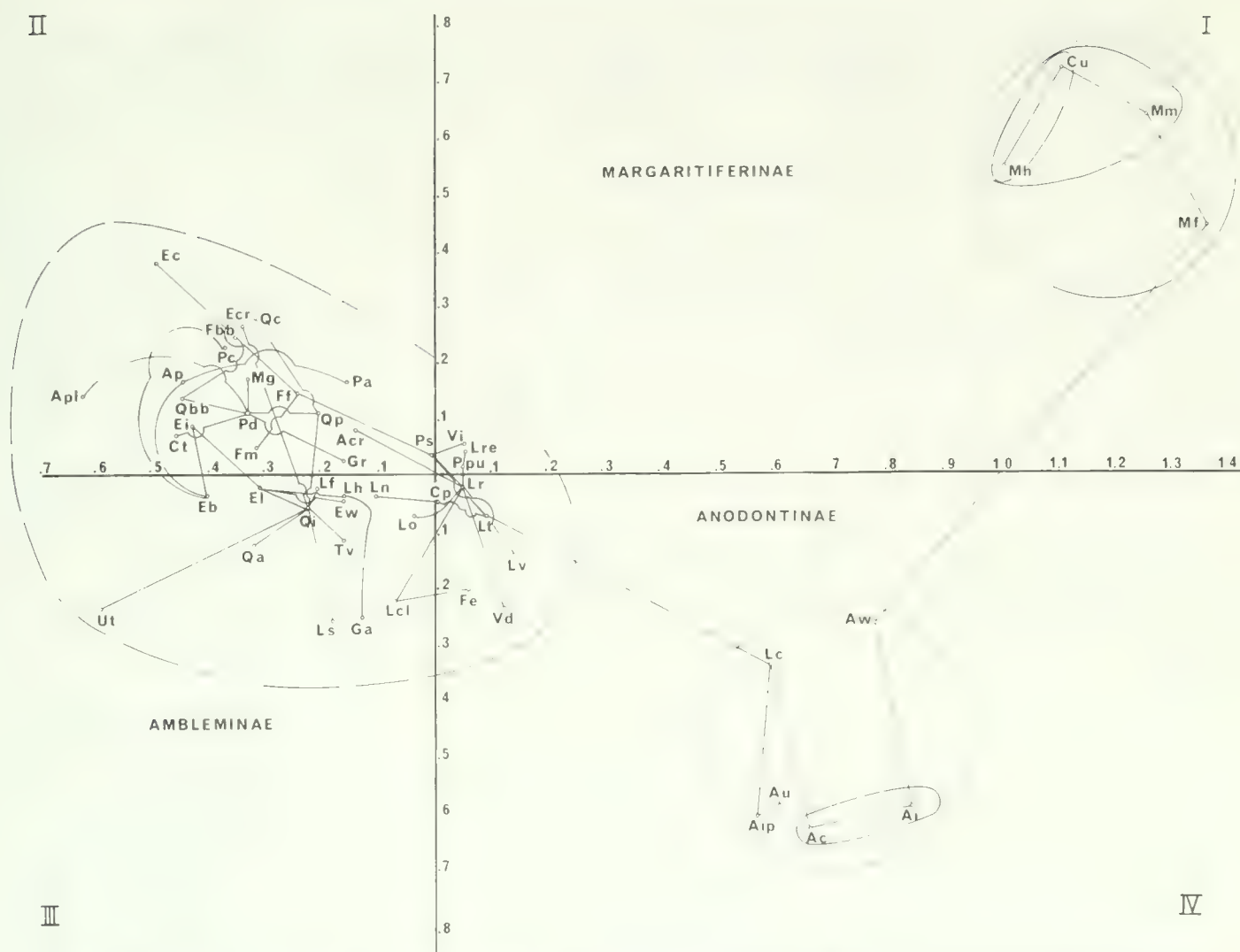

FIG. 2. Ordination diagram in two dimensions showing relationships among 52 taxa via the minimum spanning tree and subsets. The data are the percent difference when 52 taxa were analyzed using 21 sets of antisera. See text for details. Abbreviations are explained in Table 1.

*perplicata*, cluster 2. Three species of *Fusconaia* are in cluster 1; one, in cluster 3. Four species of two genera are emphasized in Table 8 because the species are not grouped in the same major cluster. Distance coefficients (d.c.) are given for those three species that are the least distant from each of the species in question. The closest relationship of *A. plicata* is with *Elliptio buckleyi* (d.c. = 0.620), its next is to *Plectomerus dombeyanus* of the 2nd cluster (d.c. = 0.97), and the third is to *A. perplicata* (2nd cluster; d.c., 1.095) or *Glebula rotundata* (3rd cluster, d.c. = 1.095). Note that in Fig. 3 the MST ties *Glebula* and *Plectomerus* together and *A. perplicata* to *Plectomerus*. On the basis of the interrelationships that revolve around *Plectomerus*, it is appropriate to consider the two species of *Amblema* to be part of cluster 2.

The situation with *Fusconaia ebena* of cluster 3 is different. Closest relationships of *F. ebena* are with *Lampsilis*, *Ptychobranchus*,

and *Glebula*, all of cluster 3. *F. flava* of cluster 1 has its closest relationship with *Elliptio* of cluster 1 (Table 8). We suspect experimental error in testing relationships with *F. ebena* (see Appendix 2, point 1).

Taxa that are grouped in subsets are listed in Table 9 with the taxonomic distances among them. There are only seven such subsets, and only two of these are found in cluster 3. The closest relationship in a subset involves *Plectomerus dombeyanus* and *Megaloniaias gigantea* (d.c. = 0.588).

By use of the MST, groupings of taxa are shown that suggest relationships (Fig. 3) that will be discussed later. 1) In cluster 1 there are no clear associations of classically defined species of *Elliptio* or *Fusconaia* that result in an *Elliptio* cluster or a *Fusconaia* cluster. 2) *Plectomerus*, *Megaloniaias*, and *Amblema* form a grouping in cluster 2. 3) *Quadrula*, *Tritogonia*, and *Cyclonaias* are linked in cluster 2. All species of *Lampsilis* are linked in cluster 3, and *Villosa* and *Proptera*

TABLE 7. Raw data (percent difference) for 15 antisera and 40 species (antigens). Key to abbreviations is given in Table 1. NC = no data available.

Species	Antisera														
	Ct	Eb	Ecr	El	Fbb	Fm	Ga	Lo	Mg	Pa	Qbb	Qc	Tv	Ut	Ec
Ga	41	NC	41	50	33	27	0	41	41	33	50	40	41	33	25
Ap	33	18	25	25	26	18	30	50	16	16	33	30	16	16	25
Fe	50	36	33	25	40	27	50	50	41	33	41	40	16	41	50
Ff	25	18	33	16	33	9	50	41	25	33	33	30	25	41	16
Fbb	25	27	50	16	0	9	40	41	33	25	25	30	41	33	25
Fm	25	36	41	16	26	0	50	41	8	33	16	40	25	41	33
Qbb	8	27	41	16	20	27	50	41	16	25	0	20	16	33	25
Qa	8	36	50	41	33	27	50	41	25	25	16	10	33	25	33
Qc	16	45	41	25	20	45	40	41	25	25	8	0	16	41	25
Pd	16	27	41	25	33	27	40	41	8	16	25	20	25	33	16
Tv	25	27	50	25	40	45	40	50	41	33	25	20	0	41	41
Mg	16	27	50	33	26	18	50	41	0	25	25	20	25	41	16
Ct	0	36	41	25	20	27	30	41	16	25	16	30	25	25	16
Ec	25	18	33	8	20	9	30	50	25	25	33	30	33	41	0
El	25	18	33	0	25	27	40	50	50	25	33	30	16	41	16
Ei	16	0	33	8	33	18	30	50	41	25	33	30	16	41	16
Ew	41	18	33	25	33	18	50	50	41	33	50	40	25	41	8
Ecr	16	27	0	8	33	27	50	41	33	25	33	20	33	41	16
Ut	25	45	16	41	26	27	20	41	33	25	25	10	25	0	33
Pc	33	NC	16	25	20	0	40	56	33	16	25	30	33	41	16
Cp	33	45	41	33	33	36	30	41	50	25	33	30	41	41	25
Gr	33	18	41	33	26	36	50	33	33	16	25	30	33	33	25
Lt	33	27	41	41	46	45	40	41	41	33	41	30	41	41	33
Lcl	41	36	33	33	33	27	50	25	58	16	33	40	25	41	33
Ls	41	36	33	16	26	36	50	16	41	16	33	40	33	16	41
Lo	33	27	41	33	33	36	40	0	33	16	41	40	33	41	41
Lh	33	36	33	16	26	36	30	25	41	25	41	30	41	41	16
Lf	25	27	25	NC	46	27	40	16	45	16	25	30	25	NC	25
Lr	41	NC	41	25	40	36	50	25	41	NC	33	30	41	41	41
Ln	25	36	25	33	26	45	30	33	33	25	41	30	33	41	33
Pa	33	27	25	25	33	18	40	41	33	0	41	30	41	33	33
Ppu	41	NC	41	33	46	45	50	33	41	8	NC	40	33	41	25
Vd	33	54	41	41	40	36	60	16	50	40	41	30	33	NC	33
Ps	33	36	33	33	40	27	50	33	33	40	41	30	33	41	25
Eb	33	0	NC	NC	26	18	30	50	25	25	25	30	NC	NC	25
Lre	33	NC	25	41	46	45	40	33	41	25	16	40	41	41	33
Acr	33	NC	50	33	33	36	40	50	25	33	8	20	16	33	25
Qp	25	NC	50	33	33	36	40	50	25	33	8	20	16	33	25
Apl	16	NC	33	16	33	9	NC	41	8	25	16	10	16	16	8
Lv	50	NC	25	33	46	45	40	16	41	41	33	40	41	41	33

link to *L. radiata*. 4) *L. radiata* is central in the *Lampsilis* cluster. 5) *Gonidea* is a distinct subgroup of cluster 3, far removed from other species of that cluster (d.c. = 1.068).

#### DISCUSSION

Evolutionary trends: primitive and derived character-states

In the evolution of freshwater bivalves, the ecological transition from the sea through

estuaries into rivers necessitated the survival of larval forms. The free-swimming veliger larvae had to be retained in the parent in order to prevent their destruction by being swept downstream or by osmotic shock. Two strategies evolved to accommodate retention of the veliger larvae; brooding young to the juvenile stage and brooding young to an early pre-pediveliger parasitic state.

The two larval retention strategies correlate with the size of the breeding adult for reasons documented by Hoagland (1975). Where one



TABLE 8. Listing of genera in each of the three clusters shown in Fig. 3. Distance coefficients are given showing the three species closest to species of those two genera apparently located in two different clusters. Coded names are given in Table 1.

	Distance coefficients		
	1.	2.	3.
Quadrant I (cluster 1)			
<i>Amblema plicata</i>	Eb (0.620)	Pd (0.970)	Apl (1.095) Gr (1.095)
<i>Elliptio</i>			
<i>Fusconaia flava</i>	Ea (0.816)	Ei (0.850)	EI (0.870)
<i>Pleurobema</i>			
<i>Uniomerus</i>			
Quadrant IV (cluster 2)			
<i>Amblema perplicata</i>	Pd (0.893)	Qbb (1.042)	Ct (1.042)
<i>Cyclonaias</i>			
<i>Megalonaias</i>			
<i>Plectomerus</i>			
<i>Quadrula</i>			
<i>Tritogonia</i>			
Quadrants II-III (cluster 3)			
<i>Actinonaias</i>			
<i>Carunculina</i>			
<i>Fusconaia ebena</i>	Lcl (0.993)	Ps (1.005)	Gr (1.125)
<i>Glebula</i>			
<i>Gonidea</i>			
<i>Lampsilis</i>			
<i>Ligumia</i>			
<i>Leptodea</i>			
<i>Ptychobranthus</i>			
<i>Proptera</i>			
<i>Villosa</i>			

TABLE 9. Taxa included in the smallest subsets together with their taxonomic distance coefficient. Ranking is by lowest to highest taxonomic distances. The smaller the distance, the closer the relationship.

Taxonomic distance	Species pairs
0.588	<i>Plectomerus dombeyanus</i> × <i>Megalonaias gigantea</i>
0.620	<i>Amblema plicata</i> × <i>Elliptio buckleyi</i>
0.631	<i>Elliptio icterina</i> × <i>E. lanceolata</i>
0.658	<i>Ligumia nasuta</i> × <i>Actinonaias carinata</i>
0.697	<i>Lampsilis radiata</i> × <i>Ptychobranthus subtentum</i>
0.777	<i>Fusconaia flava</i> × <i>Elliptio waccamawensis</i>
0.870	<i>Quadrula pustulosa</i> × <i>Q. cylindrica</i>

niche dimension is small body size, a proportionally small amount of energy is available for reproduction, few young are produced, and these are brooded to the juvenile state; there is a high probability of individual survivorship of the young. When body size is large, reproduction is delayed until large body size is at-

tained, and then proportionally large amounts of energy are available to produce numerous young that are released at an early larval stage; there is a low probability of survivorship to the young.

Native freshwater bivalves of North America are of two types: Unionacea, which are

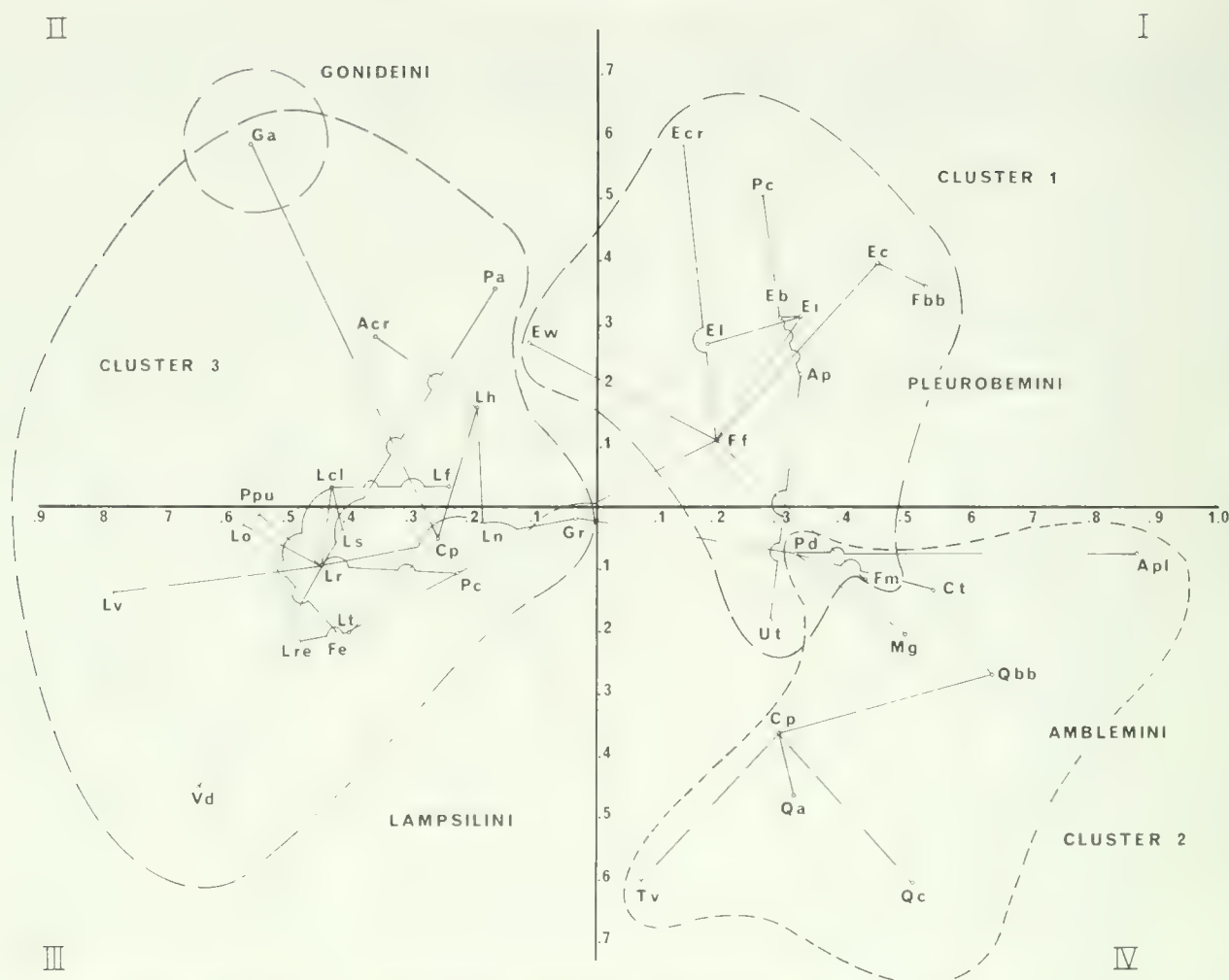

FIG. 3. Ordination diagram in two dimensions showing relationships primarily among those taxa clustered in quadrants II and III in Fig. 2 using only antigens and antisera pertaining to those taxa. Relationships are clarified by use of the minimum spanning tree and subsets. See text for details. Abbreviations are explained in Table 1.

large-bodied (most adult shells exceeding 8 cm length), and Sphaeriacea, which are small-bodied (adult shells usually are less than 12 mm in length). Sphaeriidae brood their young to the juvenile stage, whereas Nearctic Unionidae typically brood young to the glochidial (parasitic) stage. The Unionidae are sedentary as adults, and numerous species often live sympatrically side by side in the same river bed. Because of this sedentary life and the brooding of the young, it is not surprising that morphological characters serving to distinguish among species are few and that those soft-tissue characters that are useful involve structures of the demibranchs for housing the brooding young and structures of the mantle margins and pseudosiphonal regions, which interface with the aquatic environment for the purposes of pumping water and food into the animal, expelling water and waste, and getting the glochidia to the appropriate host.

Morphological character-states were considered primitive when they represented the simplest condition. Derived morphological

character-states are those showing increased organization, complexity, and specialization. We follow Ortmann (1910a, 1911, 1912b), Heard & Guckert (1971), and Heard (1974) in considering *Margaritifera* to have the most primitive groundplan of all unionaceans. We suggest that taxa with this type of groundplan probably gave rise to all other Recent unionaceans.

Primitive character-states are designated with "P" in tables 10 and 11. The most derived states are designated "S". The consideration that the direction of evolution is from primitive to derived as defined here is consistent with the facts that *Margaritifera* is ancient, known from the Cretaceous, and has a Holarctic distribution, including representation in Southeast Asia (Heard, 1974; Smith, 1977). Representative of the most derived and specialized taxa, *Lampsilis* is known from the Oligocene and is endemic in North America.

In *Margaritifera*, demibranch lamellae are held apart by randomly arranged trunks of interlamellar connective tissue. The ctenidia

TABLE 10. Morphological character-states serving to define subfamilies of Unionidae employed in this paper.

## Margaritiferinae

- \*1. No true septa—P
- \*2. No water tubes—P
- \*3. Excurrent aperture entire—P
- \*4. Diaphragm grossly incomplete—P
- \*5. No additional connective tissue at distal margin of marsupial demibranch—P
- \*6. Glochidia with irregular teeth
- \*7. Glochidia without numerous spines—P
- 8. Glochidia subspherical
- \*9. Glochidia small<sup>5</sup>—P

## Anodontinae

- 1. With true septa (parallel to gill filaments)—S
- \*2. With water tubes tripartite—S
- 3. With supra-anal opening—S
- 4. Diaphragm slightly incomplete—S
- \*5. Additional connective tissue at distal margin of marsupial demibranch—S
- \*6. Glochidia with hooks—S
- \*7. Glochidia with numerous spines—S
- \*8. Glochidia subtriangular
- \*9. Glochidia large<sup>5</sup>—S

## Ambleminae

- 1. With true septa (parallel to gill filaments)
- 2. Water tubes present, not tripartite
- 3. With supra-anal opening, but excurrent aperture sometimes entire
- 4. Diaphragm slightly incomplete
- 5. No additional connective tissue at distal margin (= ventral margin) of marsupial demibranch
- \*6. Glochidia without hooks\*\* or teeth
- 7. Glochidia without numerous spines
- 8. Glochidial shape variable
- 9. Glochidia medium sized<sup>5</sup>

\* most distinguishing character-states

\*\* except *Proptera*

5, see Appendix 2

P, Primitive

S, derived, specialized

thus lack water tubes, and the eggs and/or larvae are incubated in a flaccid sac. All four demibranchs are marsupial. When feeding and respiring, the animal exhibits a wide gape between the posterior ends of the valves, which leaves the soft tissues within vulnerable to disturbances from without. Associated with this gape is an extraordinary development of muscular arborescent papillae at the incurrent mantle aperture. *Margaritifera* lacks a separate supra-anal opening (i.e. there is no subdivision of the excurrent mantle aperture by fusion of the opposing mantle margins), and there is no clear demarcation of the anterior boundary of the incurrent aperture. Finally, at the posterior end of the gills, the diaphragm is incomplete and formed only by the ctenidia. The glochidia are tiny (about 50  $\mu\text{m}$  long) and hookless (Baker, 1928).

The sac-like marsupia, tetragenous condi-

tion, and posteriorly gaping valves are conditions associated with low species diversity and ecological restrictions to streams of pebble-cobble substrate with rapid flow of highly oxygenated water. That sac-like marsupia involve all demibranchs means that gravid gills are loaded with eggs and embryos, a condition that must interfere with respiration. Because there is little supporting storage structure within the gill to assure efficient packaging and protection, there probably is some vulnerability of the eggs and embryos to mechanical damage, especially as the posterior animal, including the gills, is exposed due to the wide shell gape and the lack of mantle sutures helping to protect the posterior region from the outside environment.

Morphologically derived character-states in other unionids involve increasing complexity of the interlamellar gill tissue and modifica-

TABLE 11. Morphological features characterizing the four tribes of the Ambleminae employed in this paper.

## Gonideini

1. Tetrigenous (mostly or all—P) or ectobranchous (perhaps some)?
- \*2. Perforated septa—P
3. Marsupia not confined to restricted regions of the demibranchs—P
4. No specialized mantle structures—P
5. Marsupial water tubes do not extend beyond distal margins of demibranch lamellae—P
6. Shells smooth—P

## Lampsilini

1. Ectobranchous—S
2. Septa not perforated—S
- \*3. Marsupia confined to restricted region of the demibranchs—S
- \*4. Many taxa with specialized mantle structures (flaps, caruncles, etc.)—S
5. Marsupial water tubes extend beyond distal margins of demibranch lamellae—S
6. Shells mostly smooth

## Pleurobemini

1. Ectobranchous (mostly) or tetrigenous
2. Septa not perforated
3. Marsupia rarely confined to restricted regions of the demibranchs
4. No specialized mantle structures
5. Marsupial water tubes do not extend beyond the distal margins of the demibranch lamellae
- \*6. Shells smooth

## Amblemini

1. Tetrigenous (mostly) or ectobranchous
2. Septa not perforated\*\*
3. Marsupia not confined to restricted region of the demibranchs
4. No specialized mantle structure
5. Marsupial water tubes not extending beyond distal margins of the demibranch lamellae
- \*6. Shells heavily sculptured (few exceptions)—S

\* distinguishing character-states(s)

\*\* except for marsupium of *Megalonaias*

P, primitive

S, derived, specialized

tions of the mantle margin. Also, there are trends of reduction in the number of marsupial demibranchs and development of specialized regions of the gill for incubation of young.

There are several derived character-states of great importance. First, the scattered margaritiferoïd interlamellar connectives were increased numerically. The advantage of more connectives probably is to increase the internal strength and stability of the gill and, therefore, the safety of its contents. Second, the connectives were organized into continuous walls (septa) that served to define and separate linear series of adjacent water tubes within the gills. Septa are perforate or imperforate. The perforate condition probably is the more primitive (Heard, 1974). Septa probably greatly increased structural support for the gills. Third, septa were aligned "vertically," i.e., parallel to the gill filaments. This vertical attachment along the filament strength-

ens the septum, and, as a simple exercise in geometry will demonstrate, less space within the demibranch is needed for parallel orientation of septa and filaments than is occupied by identically spaced septa oriented obliquely to the filaments. A reduction in space occupied by interlamellar tissue presumably would facilitate gas exchange. Fourth, a portion of the gill was set aside as a permanently modified marsupium whose interlamellar septa became thicker and more closely spaced than those in non-marsupial parts of the gill. This further reduction in the extent of the marsupium presumably facilitated respiration additionally. Indeed it may have been necessitated by proliferation of interlamellar tissue, at least in the case of very active mussels. There is a strong association between reduced marsupial size and the need for energy (and thus for oxygen). In what we regard as the most advanced Nearctic unionids (i.e.,

*Lampsilis* and its allies) are found the least extensive marsupia. These are consistently the most active of mussels, not only in terms of locomotion, but also because of the movements of specialized structures on the post-basal mantle margin (flaps, caruncles, etc., which are important in reproduction). In any case, thicker, closer-spaced septa in the marsupium strengthen it further and thus provide added protection for its contents (eggs and/or larvae).

These developments were accompanied by modifications of the bivalve hydrodynamic (water pumping) system. Modifications apparently were necessitated because development of the vertical water tube meant an increase in the distance that larvae would have to travel in order to escape the marsupium to the external environment; marsupial contents vertically evacuate the water tube and then perpendicularly traverse the excurrent pallial chamber before emission to the waterway through the excurrent mantle aperture. The necessary increase in propulsive hydrodynamic pressure was created by realizing or at least approximating a "closed" hydrodynamic system within the adult female mussel. Several devices were possible: stronger muscular adduction of the valves, close fit of the valves, increased fusion between apposing mantle margins, and/or posteriad extension of the diaphragm.

#### Morphology, immunology, and a new classification

The ordination diagrams (Figs. 2, 3) with MST and subsets indicate the classification given in Table 12. For three reasons, we argue that there are one family and three subfamilies. First, we see only two directions of morphological change from the primitive *Margaritifera* type, i.e. to the derived *Anodonta* and *Lampsilis* types. These are progressive changes within a single morphological groundplan. Few morphological changes, involving increased complexity, are needed to progress from a *Margaritifera*-type morphology to an anodontine type or to an amblemine type. We do not see abrupt differences among the three groundplans such as exist between the marine *Cardiidae* and *Tridacnidae* of the superfamily *Cardiacea*, for example, or between the marine families *Pteriidae*, *Malleidae*, and *Pectinidae* of the superfamily *Pteriacea* (see Yonge & Thompson, 1976).

Second, immunologically there are three distinct clusters, which correspond to the three morphologically defined Nearctic groups within the unionid morphological groundplan; the *Margaritifera*-type, the amblemine type, and the anodontine type (Tables 10 and 11). (Cladistic relationships among these types will be presented later.) We believe that immunologically, as well as morphologically, the three groups have equal weight. They might be interpreted as three families or as three subfamilies of a common family.

Of all the antigens discovered during our analyses only one or two were not unique to the freshwater mussels we used. This suggests strong immunological cohesion of this group. The average genetic distances among the three mussel subgroups were close to 50%. This reinforces the conclusion (above) that the three groups are not far apart genetically. Therefore we conclude that the three groups are best regarded as subfamilies within one family. The taxonomic results are Unionidae: *Margaritiferinae*, *Anodontinae*, and *Amblesminae*. The greatest difference is between the *Anodonta* and *Margaritifera* groups; the least between the *Amblesma* and *Margaritifera* groups.

What is the relationship between immunoelectrophoretic genetic distance, as presented here, and taxonomic hierarchy? The relationship is not a simple one; there is no direct correspondence. Classifications traditionally have been based on comparative morphology. Increments of change in the taxonomic hierarchy follow discrete changes in morphological groundplans. Pronounced changes in morphology and behavior can occur rapidly with respect to geological time (Stanley, 1979). These changes, presumably under the control of regulatory genes, may involve few genetic changes involving regulatory genes, yet be pronounced enough to impress taxonomists that the taxon in question belongs in a different higher-category taxon from that of the taxon most closely related to the one in question. Such morphological change may not be accompanied by an equal amount of change in structural proteins. The now classic example is one involving man and chimpanzee. These animals are classified in different families on the basis of considerable morphological and behavioral divergence. However, the molecular genetic distance between man and chimpanzee is very small, essentially equal to the genetic distance among sibling

TABLE 12. Comparison of major classifications showing similarities and differences. Genera are not listed if the subfamily of an author is equivalent to the tribe or subfamily of Davis et al. (1978).

Davis et al., 1978 <sup>6</sup>	Davis & Fuller <sup>6</sup> (this paper)	Ortmann (1910a, 1916)	Heard & Guckert (1971)	Modell (1942, 1949, 1964)
A. Unionidae	A. Unionidae	A. Unionidae	A. Margaritiferidae†	A. Margaritiferidae†
I. Margaritiferinae	I. Margaritiferinae	I. Margaritiferinae	I. Margaritiferinae	I. Margaritiferinae
<i>Margaritifera</i>			II. Cumberlandiinae†	II. Pseudodontinae†
(+ <i>Cumberlandia</i> )			B. Unionidae†	<i>Gonidea</i>
II. Anodontinae	II. Anodontinae	II. Anodontinae	I. Anodontinae	B. Elliptionidae†
<i>Anodonta</i>			II. Lampsiliinae	III. Alasmidontinae†
<i>Alasmidonta</i>			III. Pleurobemininae †	<i>Alasmidonta</i>
<i>Lasmigona</i>			<i>Cyclonaias</i> *	<i>Lasmigona</i>
III. Lampsiliinae	III. Lampsiliinae†	III. Lampsiliinae†	<i>Elliptio</i>	IV. Lampsiliinae
1. Lampsilini			<i>Pleurobema</i>	V. Pleurobemininae†
<i>Actinonaias</i>			<i>Uniomerus</i>	<i>Fusconaia</i>
<i>Carunculina</i>			IV. Popenaiadinae†	<i>Pleurobema</i>
<i>Glebulula</i>			<i>Popenaias buckleyi</i> *	VI. Elliptiiniinae†
<i>Lampsilis</i>			C. Amblemidae†	<i>Elliptio</i>
<i>Leptodea</i>			V. Gonideinae†	<i>Uniomerus</i>
<i>Ligumia</i>			VI. Ambleminae†	<i>Popenaias</i>
<i>Proptera</i>			<i>Amblema</i>	VII. Ambleminae†
<i>Ptychobranchus</i>			<i>Fusconaia</i> *	<i>Amblema</i>
<i>Villosa</i>			<i>Plectomerus</i>	<i>Plectomerus</i>
2. Gonideini	2. Gonideini	IV. Gonideinae†	C. Amblemidae†	C. Unionidae†
<i>Gonidea</i>			V. Gonideinae†	VIII. Quadrulinae†
3. Elliptiini	3. Pleurobemini	V. Unioninae†	VI. Ambleminae†	<i>Cyclonaias</i>
<i>Elliptio</i>		<i>Elliptio</i> *	<i>Amblema</i>	<i>Megalonaias</i>
<i>Fusconaia</i>		<i>Fusconaia</i> *	<i>Fusconaia</i> *	<i>Quadrula</i>
<i>Pleurobema</i>		<i>Pleurobema</i> *	<i>Plectomerus</i>	<i>Quincuncina</i>
<i>Uniomerus</i> <sup>2</sup>		<i>Uniomerus</i> *	<i>Quadrula</i>	<i>Tritogonia</i>
4. Amblemini	4. Amblemini	<i>Amblema</i>	VII. Megaloniaidinae†	IX. Anodontinae†
<i>Amblema</i> (+ <i>Megaloniaias</i> ;		<i>Megaloniaias</i>	<i>Megaloniaias</i>	<i>Anodonta</i>
<i>Cyclonaias</i>		<i>Plectomerus</i>	<i>Megaloniaias</i>	X. Rectidentinae†
<i>Plectomerus</i> )		<i>Cyclonaias</i>	<i>Megaloniaias</i>	<i>Pyganodon cataracta</i>
<i>Orthonymus (=Q<sub>c</sub>)</i>		<i>Orthonymus</i>	<i>Megaloniaias</i>	
<i>Quadrula</i>		<i>Quadrula</i>	<i>Megaloniaias</i>	
<i>Quincuncina</i> <sup>3</sup>		<i>Quincuncina</i>	<i>Megaloniaias</i>	
<i>Tritogonia</i>		<i>Tritogonia</i>	<i>Megaloniaias</i>	

A, etc., families.

I, etc., number of subfamilies.

1, etc., number of tribes.

†, suprageneric taxon that is not equivalent to our taxon, or a taxon we cannot agree to. See text for details.

\* , genus belonging to a different suprageneric taxon considering the other genera with which it has been grouped, and considering generic placement in the Davis & Fuller superscript 2,3,6 See Appendix 2, Annotations.

species of other organisms (King & Wilson, 1975).

However, there is strong evidence that, once lineages have begun to diverge and are reproductively isolated, there is a rather regular increase in molecular genetic distance with increasing time (Fitch, 1976; Sarich, 1977). Further, there seem to be rapid and slow rates of certain loci in protein evolution that can be detected electrophoretically. The contribution of rapidly evolving loci should be completed in some six million years, while further increases in genetic distance are contributed by the slowly evolving loci (Sarich, 1977). Given the divergence of *Margaritifera*, *Anodonta*, and *Ambleminae* at least by the late Cretaceous (i.e. 60 million years ago), one would reasonably expect considerable genetic distance among these naiad taxa.

In the few immunoelectrophoretic studies such as this one, species of different gastropod families, but of the same superfamily, have differed from 40% to 80% and most have differed by 50% to 80% (Davis & Suzuki, 1971; Davis, 1978). Using allozyme electrophoretic analyses, and considering changes in *I* between different hierarchical levels in other organisms (Davis et al., 1980) we have found that genetic similarity between *Margaritifera* and our *Ambleminae* was greater ( $I = 27\%$ ) than we would expect if these taxa belonged to different families.

In summary, given the 47% immunoelectrophoretic genetic distance between our *Margaritifera* and *Ambleminae* and considering the great age of divergence of these taxa, we think it reasonable to consider them to belong to a single family, the Unionidae. This is supported by the cohesiveness of the unionid morphological groundplan, which includes a single larval type (the glochidium).

The three subfamilies are cohesive and distinct immunologically and morphologically. Morphological character-states that aid in distinguishing among these taxa are marked with an asterisk in Tables 10 and 11.

The *Margaritifera* have been discussed above in terms of character-states that have been considered primitive and that in some cases are unique to taxa of this subfamily.

The *Anodontinae* are defined, in part, by unique derived character-states, indicated in Table 10. These states have been discussed previously, for the most part (Ortmann, 1910b, 1911, 1912b; Heard, 1975). Known *Anodontinae* have an extraordinary type of glochidium, whose shell is subtriangular in lateral outline, usually large and powerful, and

armed with spined hooks at the apex of the ventral margin. The powerful, well armed anodontine glochidium can sever soft host tissues (e.g. the gill filaments of fishes) and prematurely fall from the host to the streambed, where it will die. On the other hand, this type of glochidium fares well on tougher tissues (e.g. the fins and even the scales of fishes) and thus occupies a metamorphic niche that has been rarely exploited and perhaps chiefly vacated by weaker types of unionid glochidia.

The anodontine marsupium exemplifies Simpson's (1900, 1914) group *Homogenae*, yet it is of a unique type. During gravidity a marsupial water tube adopts a tripartite construction: secondary septa develop parallel to the inner and outer demibranch lamellae. The object presumably is to facilitate additional gas exchange for the marsupial contents. The dorsal margins of gravid water tubes are sealed by a film of connective tissue, whose purpose presumably is prevention of the escape of eggs and the premature escape of larvae. With one known exception, the egg mass is loosely structured. Premature loss of ova and larvae to the excurrent mantle chamber would be a great threat were it not for the dorsal tissue.

Gravid anodontine marsupia are greatly and uniquely swollen. This is facilitated by another unique feature, the development along the distal margins of the outer demibranchs of additional connective tissue during gravidity. This device permits the apposing lamellae to separate and move apart. The entire phenomenon necessitates the presence of the secondary water tubes (above) and probably is a response to the need for space in order to incubate competitively large numbers of offspring, which are themselves exceptionally large, as noted earlier.

The typically loose structure of the egg and larval masses is caused by the great size of the marsupial contents, which cannot pack together so securely as can those small ova and glochidia of other unionid groups. On the other hand, the loose mass is an advantage because the adult does not have to overcome the inertia of a large mass during expulsion of marsupial contents. Instead, the glochidia can be pumped out singly or in small numbers. The advantage is of even greater value for very thin-shelled, low-density species, whose poor valve adduction and fit weaken the hydrodynamic system.

The *Ambleminae* are like the *Anodontinae* in that the water tubes parallel the gill fila-

ments; the posterior mantle is not united, but drawn together by the diaphragm, to effect functional separation of incurrent and excurrent apertures; the excurrent aperture is closed above, which effects a supra-anal opening separate from an anal one; and the diaphragm is almost complete and is formed entirely by the ctenidia. These two subfamilies differ in that most Ambleminae: Amblemini and some Ambleminae: Pleurobemini are tetragenous, whereas Anodontinae are ectobranous; amblemine glochidia are hookless and are of various shapes and sizes but never so large as the anodontine glochidia or hooked in the same way; and amblemine water tubes are undivided at all times.

We distinguish four subgroups of Ambleminae: Gonideini, Lampsilini, Amblemini, and Pleurobemini (Table 11). There are few unique morphological character-states serving to define these tribes. The Gonideini have perforated septa and are tetragenous; the Lampsilini have specialized marsupial (in most taxa) and postbasal mantle modifications (many taxa) and are ectobranous; the Pleurobemini have smooth shells and no specialized marsupial features or postbasal mantle structures and mostly are ectobranous; and the Amblemini have heavily sculptured shells and mostly are tetragenous.

We have not employed the subfamily name Unioninae because we do not know how *Unio* s.s. of Europe relates to North American Unionidae. Ortmann (1912b) did not consider *Unio* s.s. to be equivalent to North American taxa that have similar morphology of shell and soft parts. Heard & Vail (1976) provided an excellent account of the morphology of *Unio*. *Unio* differs from our Ambleminae by having glochidia with hooks, perforated marsupial septa and imperforated non-marsupial septa, subtriangular and medium-sized glochidia. *Unio* and allied taxa have a smooth shell, undivided water tubes, and ectobranous marsupium. The genetic relationship of *Unio* s.s. to our Ambleminae and Anodontinae must be determined before we can consider the use of this taxon name for a higher-category taxon below the level Unionidæ. However, the groundplan of the Eurasian *Unio* is generally so like our Ambleminae: Pleurobemini type that we preserve the traditional usage of the name at the family level.

#### Comparison of classifications

Eleven classifications are given in Appendix 1. These classifications represent three

very different types of approach, and much is to be learned from their study. An historical account of unionid classification is given in Appendix 4. The three approaches that have been used are based on 1) conchology only, 2) selected use of a few key characters, 3) use of all data available and asking questions about how character-states evolved and about the relationships of character-states to environments. Of all the classifications prior to our own, only Heard & Guckert (1971) clearly stated the basis for their classification. Accordingly, we will first contrast our classification with theirs and, by so doing, address various problems raised in the Introduction.

We reject the Heard & Guckert classification for three reasons.

First, they used the character "number of marsupial demibranchs" to establish families. They used the Amblemidæ to accommodate all non-margaritiferine unionids with four marsupial demibranchs; those taxa with two outer demibranchs marsupial were considered Unionidae. On the basis of immunologically derived relationships, it is clear that the tetragenous condition has undergone parallel evolution and that reduction to two marsupial demibranchs has occurred at least four and possibly five times, i.e. at the origin of the *Anodonta* clade, during the evolution of recent Ambleminae, and within the lineages of the Amblemini and Pleurobemini; it possibly has occurred in the Gonideini.

It should not be surprising that reduction of marsupial demibranchs occurred several times once greater efficiency in the hydrodynamic system had been achieved. Any reduction in the space taken up with marsupial function would mean increased efficiency in respiration. Specializations in how glochidia are incubated and delivered to their hosts correlate with different reproductive strategies.

Second, they created two new subfamilies on the basis of length of breeding season: the Megaloniadinae and the Popenaiadinae within their families Amblemidæ and Unionidae, respectively. The new subfamilies contained only taxa that are bradytictic, whereas the other subfamilies of their Amblemidæ and Unionidae are tachytictic. An examination of Fig. 3 clearly shows that there is no separate clade that separates *Megalonias* from other taxa or so-called *Popenias buckleyi* from its congeners (*Elliptio*). Heard & Guckert (1971) created their new subfamily concept Popenaiadinae primarily because of information about *E. buckleyi* (see Fuller, 1975). We do not, however, have biochemical data for *Popenias*



*popei* (Lea), so this subfamily has not been fully invalidated (but see Fuller, 1975).

It clearly is unacceptable to create higher taxa on the basis of length of breeding season. As with the question of how many demibranchs and water tubes bear glochidia, the question of length of breeding season seems more correlated with reproductive strategy than with diverging clades. This character (length of breeding season) in most cases should not be used to assess taxonomic relationships among unionid taxa.

Third, they created the subfamily Cumberlandiinae to provide a subfamily for the monotype *Cumberlandia monodonta* (Say), which is the only margaritiferae sensu nostra of the Mississippi basin and is confined to it. This rank was based on a single character state, the proliferation of interlamellar connective tissue approximating true septa. We argue that *Cumberlandia* (described by Ortmann, 1912a) is not deserving of subfamily rank, and that it may best be considered a synonym of *Margaritifera*. On the basis of immunological data *C. monodonta* is in the same subset with *M. margaritifera* (Fig. 2). The MST shows that *C. monodonta* is intermediate in relationship between *M. margaritifera* and *M. hembeli*. *M. falcata* is more distantly related to *M. margaritifera* than is *Cumberlandia monodonta*. We consider these relationships to be accurate as shown because we had antisera for each of the four species and thus could make the appropriate cross-comparisons.

What distinguishes *Cumberlandia monodonta* from the other three species is the somewhat continuous, oblique "septa" of the former in contrast to the patternless interlamellar connectives of the latter. We consider this small modification of the "septum" to be indicative of a species difference in the *Margaritifera* complex and thus we consider *Cumberlandia*, on all data available, to be a synonym of *Margaritifera*. We see no reason to use subgeneric rank at all. We are especially confident of our conclusions because we have tested and examined every nominal Nearctic margaritiferae species: *Cumberlandia monodonta* of the Mississippi basin, *Margaritifera hembeli* of the Gulf drainage, *M. margaritifera* of the northern Atlantic drainage, and *M. falcata* of the Pacific drainage.

We compared our classifications with those of Ortmann (1910a, 1911, 1912a, 1916, 1919) and Modell (1942, 1949, 1964), as well as Heard & Guckert (Table 12). These classi-

fications were chosen because Ortmann's work stands for the totally synthetic approach; Modell's is a sprawling classification based on shell characters; and the Heard & Guckert classification purposely ignores conchology and is essentially monothetic with some attention to reproductive characters.

It is clear that there is closest agreement between our classification and that of Ortmann, especially his earliest work (1910a). In his later work Ortmann (1911, 1912b, 1919) elevated the group of *Margaritifera* to familial status. Accordingly, in scoring divergence of other classifications from ours, we used a range for Ortmann's classification based on his earlier and later schemes. We arbitrarily gave 5 points for each family or subfamily that is not equivalent to our comparable family or family concept (Table 12, †) and one point for a genus that has been placed with another genus (genera) that belongs to another suprageneric taxon in our classification (Table 12, \*). Ortmann's score is 19 or 29; the Heard & Guckert score, 48; Modell scores 55. On this basis, Modell's classification is the least satisfactory.

Modell (1942, 1949, 1964) established a strictly conchological classification of three families and 10 subfamilies with Nearctic members. Heard & Guckert (1971) and Heard (1974) were mostly correct in stating that shell characters typically do not correlate with soft-part characters. For the most part shell characters do not correlate with anatomical characters or genetic data, also we have discussed the reasons for rejecting a two- or three-family classification. *Gonidea* is not closely related to *Margaritifera* even though the shells are somewhat similar. *Alasmidonta* and *Anodonta* are closely related genera of the same subfamily, and neither is closely related to *Lampsilis* or *Elliptio*. Numerous other objections to Modell's scheme could be raised. We have discussed our far fewer objections to the Heard & Guckert classification. Our classification is closest to Ortmann's (1910a) original arrangement, i.e. one family and the subfamilies Margaritinae (= Margaritiferae), Unioninae, Anodontinae, and Lampsilinae. Indeed, the combination of his North American Unioninae, Lampsilinae, and (1916) Gonideinae equals our Ambleminae. Moreover, his Lampsilinae and Gonideinae have exact cognates in our amblemine tribes Lampsilini and Gonideini.

Our classification thus differs from Ortmann's in three significant ways. First, his

Unioninae comprised diverging clades, i.e. our Amblemini and Pleurobemini. Ortmann lacked the biochemical tools necessary to reveal genetic relationships and parallel evolution that are crucial to our concepts Pleurobemini and Amblemini. Second, by raising what we consider tribes to subfamily rank he implied greater morphological and genetic divergence among groups than we think justifiable. Third, no previous author recognized that the Anodontinae are as distinct and separate a group as indeed they are. While the anodontine taxa have unique morphological character-states that set them apart, these do not appear to present as great a magnitude of difference in comparison with the comparable character-states of our Ambleminae as in comparison with those of the Margaritiferinae. In other words, the Anodontinae have advanced beyond the Margaritiferinae about as far as the Ambleminae have done, but divergently.

Given the evolving differentiation of the gills as efficient marsupial chambers, one could argue on the basis of morphology that our Amblemini and Pleurobemini are the most primitive of Nearctic non-margaritiferinae taxa; they lack the complex mantle structures of some of our Lampsilini, and many species have heavy shells, some resembling those of *Margaritifera*. The anodontine species could have been considered (and indeed, have been so considered by some authors) as derived from our Ambleminae with advanced specialization that included a reduction from heavy to light shell, reduction of hinge, and further marsupial development to yield the tripartite water tube. This definitely has not been the case.

Considering all classifications and in summary we can make several points. 1) Whenever a monothetic basis for classification has been used, the classification places closely related taxa into artificial groupings. 2) Ortmann's approach is superior because he used all data available. He was interested not simply in a utilitarian classification, but also in obtaining answers to why and how morphology and habits yielded the amazing unionid diversity in North America. 3) The Heard & Guckert (1971) study is of particular value because it purposefully set up a classification following a stated approach. They provided clear-cut concepts that are amenable to establishing hypothesis that can be tested. 4) Heard & Guckert were mistaken in "subjectively electing . . . to ignore one array of fea-

tures (i.e., conchological features)" and in overemphasizing such reproductive aspects as number of marsupial demibranchs and length of breeding season.

#### Relationships within the Ambleminae

We discuss at some length relationships among certain taxa within the Ambleminae because of our extensive immunological data and the availability of a certain amount of anatomical data.

1. *Gonidea*—The placement of this genus in a taxonomic hierarchy has continuously been a problem to malacologists. On the basis of the shell it would be considered a margaritiferine. Modell (1942, 1949, 1964) considered this to be the case and relegated *Gonidea* to his Pseudodontinae of the Margaritiferidae. Ortmann (1916) considered *Gonidea* a member of the Unionidae: Gonideinae. Heard & Guckert (1971) placed *Gonidea* in their Amblemidae because the genus is tetragenous. They preserved Ortmann's (1916) Gonideinae for it because of its perforated septa. Heard (1974) reported that *Megaloniaias* has perforated septa and considered them characteristic of primitive tetragenous taxa, such as *Gonidea*, *Megaloniaias*, and *Pseudodon*.

*Gonidea* is immunologically more closely related to our core Ambleminae (Fig. 3). *Gonidea* diverges away from the Amblemini and Pleurobemini and can in no way be considered a member of the Margaritiferinae. With the *Anodonta* group removed from Ortmann's equal ranking of Anodontinae, Gonideinae, Unioninae, and Lampsilinae, we see that *Gonidea* deserves equal rank with Ortmann's generic groupings around *Lampsilis* (our Lampsilini) and around *Elliptio* and *Quadrula* (his Unioninae, our Pleurobemini and Amblemini). Because *Gonidea* has vertical septa and a complete diaphragm, in contrast to the primitive margaritiferine groundplan, we consider its perforations a primitive condition that has been sustained in the Gonideini and, by parallel evolution, in *Megaloniaias* of the Amblemini. It is possible that this west coast North American genus is most closely related to the tetragenous genera of Asia (Heard, 1974). Further investigations are necessary to assess such a suggested relationship. Should this proposed link to Asia be correct, it is probable that the Gonideini would deserve subfamily ranking.

2. The *Elliptio-Fusconaia-Pleurobema* problem. Immunologically and morphologically there is little basis for taxonomically separating these genera. *Pleurobema* and *Elliptio* are ectobranchous, and *Fusconaia* is tetragenous. However, species assigned to these taxa do not sort into two or three immunologically separate clusters. Clarification of relationships within the Pleurobemini will depend on molecular genetic studies using taxa only in this group, plus more sets of Pleurobemini antisera. As seen in Tables 13 and 14, when the 12 traditional genera of Pleurobemini and Amblemini are compared by using eight characters, *Fusconaia* differs from *Elliptio* in three character-states and from *Pleurobema* in two. *Fusconaia* differs from both genera in having brightly colored tissues and in being tetragenous. *Elliptio* differs from both *Fusconaia* and *Pleurobema* in having simple, not dentritic, incurrent papillae.

We shall retain these genera until such a study has been completed. The genera are tentatively defined as follows: *Elliptio*, ectobranchous, simple incurrent papillae, shells more or less elongate with beaks placed well anterior and not prominent; *Pleurobema*, ectobranchous, dentritic incurrent papillae, shells subtriangular to rhomboid with beaks anterior or subanterior and prominent; and *Fusconaia*, tetragenous, dentritic incurrent papillae, shell much as in *Pleurobema*.

However these taxa are defined in the future, we note that so-called *Elliptio*, *Fusconaia*, and *Pleurobema* are very closely related genetically.

3. Linkages in the Lampsilini—The immunological data (Figs. 2, 3) show that 1) the closest relationship of the Anodontinae to the Ambleminae is via the genus *Lampsilis*, specifically *L. teres*, 2) *L. teres*, *Ptychobranhus subtentum*, and *L. radiata* form the core of related taxa from which other taxa fan out. 3) The Pleurobemini and Amblemini are closely related to each other and there does not appear to be an extensive divergence among genera of these tribes. 4) *Gonidea* ties into *L. teres* via *Carunculina parva*.

Because the relationships indicated by the MST represent genetic relationships among living taxa, and as new taxa are studied and added to the data matrix, one would expect shifts in relationships from those seen in Figs. 2 and 3. Accordingly, one should not consider the overall MST pattern to represent evolutionary pathways. For example, *Lampsilis teres* did not evolve from *Lasmigona costata*. Also,

as additional anodontine taxa are studied, the linkage between the Anodontinae and Ambleminae might not be between *Lasmigona costata* and *Lampsilis teres*. Realizing that with additional data there will be shifts in associations of taxa along the MST, we can still say quite a lot about general relationships among groups of genera in the Ambleminae. It is clear that the amblemine clade is ancient and that the genus *Lampsilis*, of all taxa within this clade, is most closely related to the Anodontinae.

4. The *Amblema-Plectomerus-Megaloniaias* complex—Immunological data indicate a close relationship among species of these three genera. *Megaloniaias* and *Plectomerus* are especially closely allied within the same subset (Table 10). There is a remarkable piece of morphological evidence that corroborates the implied close genetic relationships of these three taxa. Arborescent incurrent papillae are characteristic of our Amblemini (*Quadrula* s.s. and *Quincuncina* have dentritic papillae); incurrent papillae of the simple type do occur, but *only* in the trio of genera in question. In short, these form a natural group within the Amblemini.

*Plectomerus* and *Megaloniaias* are immunologically so closely related as to suggest congeneric status. There are data supporting and against congeneric status. The supporting data would include *Amblema* with them in a common genus because all three have large, strong, thick, heavy shells with plicate sculpture (three different character-states). In view of the above data, these taxa are allied on the basis of four distinct character-states (3 shell, 1 soft-part) additional to those serving to define the Lampsilini (in addition to the close immunological relationship).

Differences occur. *Megaloniaias* possesses a somewhat unusual beak sculpture (i.e. it persists until after adult sculpture has begun and thus intermingles with it). *Megaloniaias* exhibits perforate gill septa, at least in the gravid female (Heard, 1974). Both character-states are considered primitive. Unfortunately, *Plectomerus* has not been studied adequately in regard to these character-states. *Amblema* beak sculpture is separate from the disc of the adult shell; it has no known perforate septa.

Given the total evidence available, given the comparisons in Tables 13 and 14, and considering the morphological changes one expects to see in adaptive radiation (Davis, 1979), we consider it worthwhile to make a



hypothesis that these three taxa are congeneric and that the synonymy is:

- Amblema* Rafinesque, 1820
- + *Plectomerus* Conrad, 1853
- + *Megaloniaias* Utterback, 1916

5. The *Cycloniaias-Quadrula-Tritogonia* complex—We studied at least five Amblemini taxa that have complex pustulate shell sculpture: *Quadrula* spp., *Q.* (= *Orthonymus*) *cylindrica*, *Cycloniaias tuberculata*, *Tritogonia verrucosa*, and *Quincuncina infucata*. Admittedly some species traditionally assigned to *Quadrula* have smooth or nearly smooth shells. However, as noted in the discussion of *Q. cylindrica* (below), the genus *Quadrula* has yet to be defined with precision. Also, subgenera such as *Q. (Bullata)* Frierson [represented by *Q. pustulosa* (Lea)] may or may not have validity.

*Quadrula cylindrica* differs from the other species of *Quadrula* we studied in 4.5 morphological character-states (shell and soft parts) (Tables 13, 14). *Q. cylindrica* has arborescent incurrent papillae such as occur in the Margaritiferinae and *Gonidea* of the Ambleminae; these papillae are considered to represent a primitive character-state. Excurrent papillae are absent (contrast *Quadrula* s.s. and *Quincuncina*); tissues are various shades of browns and blacks (contrast uncolored tissues of other genera studied here except *Fusconaia* and *Margaritifera*). Other differences involve shell sculpture. On the basis of molecular genetics (immunological distance coefficients), the closest relationships are with other species of *Quadrula* [*Q. pustulosa* (0.870); *Q. cf. quadrula* (Qbb, 0.902); *Q. apiculata* (1.04) and then *Plectomerus* (1.04)]. Because *Q. cylindrica* differs from *Quadrula* s.s. in three anatomical (soft part) character-states, we consider *Q. cylindrica* to typify a distinct genus, *Orthonymus*.

*Cycloniaias*, a monotypic genus, closely resembles *Quadrula* conchologically. Of the Amblemini genera, only *Cycloniaias*, *Orthonymus*, and *Tritogonia* have arborescent papillae and no (or poorly developed) excurrent papillae. *Cycloniaias* differs from all other Amblemini studied by us in being ectobranchous and having an entire excurrent aperture. The immunological distance coefficients among *C. tuberculata* and the five closest species are, in increasing order: *Plectomerus* (0.780); *Quadrula cf. quadrula* (Qbb, 0.826); *Megaloniaias* (0.966); *Q. pustulosa* (1.04);

and *Q. apiculata* (1.05). No immediate genetic relationship to *Orthonymus* or *Tritogonia* is indicated. Because *Cycloniaias* differs from *Quadrula* in three morphological character-states and from *Amblema* (plus synonyms) in at least six character-states (Tables 13, 14), we shall maintain *Cycloniaias* as a discrete genus.

*Tritogonia* is maintained as a separate genus because it has arborescent papillae, not in *Quadrula* s.s., and a different shell sculpture (Table 13). Its closest immunological relationships are with *Quadrula pustulosa* (0.870) and *Orthonymus cylindrica* (0.219) and then with non-Amblemini, e.g. *Elliptio lanceolata* (1.257) and *Lampsilis teres* (1.263).

6. Lampsilini—The Lampsilini are unique among the Unionidae in that the marsupial water tubes extend beyond the distal margins of the demibranch lamellae; the marsupia show externally marked sulci, not the smooth pads as in the homogenous taxa (tetragenous or ectobranchous); and discrete areas of the outer demibranch are marsupial in the great majority of species.

It is reasonable to assume that in the evolution of the Lampsilini there were independent origins of some of the marsupial types and that some developed from others. For example, it is improbable that the mesogenous condition (Appendix 3) was modified to produce the heterogeneous condition, because the two are structurally different and occupy different parts of the outer demibranchs. Nevertheless, there is a progression from primitive to specialized character-states.

Presumably the most primitive state is longenous: the entire length of the demibranch is marsupial, and the distad distension of the water tubes is slight. This is not a very successful state; only two genera have been assigned to the Lampsilini: Longenae (a possible subtribal concept): *Friersonia* and *Cyrtonaias*. We have not studied these genera immunologically. Additional information about them occurs in Ortmann (1912b), Heard & Guckert (1971), and Fuller (1975).

A condition possibly derived from the longenous is the ptychogenous state. Here the marsupium extends the full length of the demibranch, but only the ventral portions of the water tubes are marsupial. Additional space for incubation of larvae is created by a distad distension of the water tubes that is greater than that in the Longenae: the tubes

are somewhat distended laterally and from front to rear, which causes a folded ("ptychogenous") condition such that the lower border of the demibranch is furlbeled. Only *Ptychobranchnus*, the only genus of Ptychogenae, has this condition (Fig. 3).

The eschatigenous condition (in the lone genus of Eschatigenae, *Dromus*, not studied here) resembles the ptychogenous type in being limited to the ventral border of the demibranch, but is unique in consisting of a series of several discontinuous sacs formed by a distad distension of the marsupial water tubes that exceeds that in ptychogenous mussels.

The mesogenous condition (in the Mesogenae, *Obliquaria* and *Cyprogenia*, not studied here) involves great distad distension of several contiguous water tubes in the middle of the demibranch; the distensions exceed those in the eschatigenous marsupium, and in *Cyprogenia* they are so long that they must coil in order to remain within the mantle cavity and thus be protected by the shell.

The heterogenous condition is restriction of the marsupium to the posterior (or even the postbasal) portion of the demibranch. All other Lampsilini are Heterogenae.

Results of our immunological analysis of Heterogenae are represented in Fig. 3. The eventual addition of other taxa to the analysis doubtless will change this portrayal in some respects and will permit greater confidence in all the results of that time. At present, however, the picture has some features that are gratifyingly in keeping with morphological evidence; there are, also, some relationships that are mystifying. In the former category, there is, for example, the radiation of several *Lampsilis* and *Villosa* from *L. radiata*. This is not surprising, because of the similarity of the two genera and because this species is not an advanced member of the genus (the mantle flap is essentially ribbon-like, unlike the fully developed piscine type seen in *L. ovata*). Also of note is that *L. teres* is not a part of this radiation, because its postbasal mantle margin questionably forms a flap of the sort exemplified by *L. ovata*, the type-species of the genus and a member of the radiation from *L. r. radiata*, and because its beak sculpture, also, is atypical of the genus. A further interesting aspect of *L. teres* is its immunological alliance to *Ligumia recta* (Rafinesque), which it resembles morphologically so much that it long was the accepted practice to place *Ligumia* in *Lampsilis*. One concludes that in at least some cases conchological evidence is

more meaningful than has been recognized in many years.

The opposite point is indicated in some other cases. For example, *Ligumia recta* and *L. nasuta* have been considered congeneric because of their similar shells, but they are not closely allied in our immunological analysis. We cannot be confident that we fully understand these two species' relationship. We feel even more uncertainty about our results concerning *Lampsilis hydiana*. This species seems morphologically to be related to (or even part of) the sprawling *Lampsilis r. radiata* complex, but immunologically it not only is not part of the radiation centered in that subspecies, but also lies a great genetic distance from it. Entirely unexpected results, such as these, strongly suggest the need (and some directions) for further study.

These remarks about relationships within the Lampsilini serve to illustrate some of the apparent strengths and weaknesses of our analysis. The same point can be made about the indicated relationships between the Lampsilini and other tribes and subfamilies. We think it significant that *Ptychobranchnus* (Ptychogenae) is both the genus of Lampsilini studied by us that has been considered most generalized by some (e.g., Ortmann, 1912b) and the one that serves as the immunological connector to the Ambleminae: Pleurobemini and (though *Lampsilis teres*) to the Anodontinae. Similarly, the pathway between the Lampsilini and the Ambleminae: Amblemini lies through *Glebula*, a monotypic, generalized genus in the Heterogenae. We by no means anticipate that these details would remain unmodified in the event of an analysis of a larger number and variety of taxa, but we find it intuitively satisfying that rather unspecialized animals are the connections of the present scheme.

#### Adaptive radiation and success

Changes from primitive to derived character-states presumably indicate entrances into new adaptive zones and the establishment of new groundplans that engendered adaptive radiation. In considering the success of groups with various groundplans, we are concerned with 1) the extent of a given adaptive radiation, i.e. the number of species radiating with a given morphological groundplan; 2) the geographic range and abundance of these species, and 3) the competitive ability of the

species that enables coexistence with other, sympatric unionid species.

As discussed previously, the critical factors for unionid success appear to involve aspects of reproduction and respiration that depend on hydrodynamic efficiency; the critical factor for increased hydrodynamic efficiency is the bivalve diaphragm. The diaphragm is a collection of tissue that more or less separates the incurrent and excurrent portions of the mantle cavity. The unionid diaphragm is incomplete, i.e. the separation of incurrent and excurrent mantle cavities is imperfect and a tightly closed hydrodynamic system is thus impossible. In the Margaritiferinae this difficulty is exacerbated because the gill extends posteriad far short of the posterior mantle margin and only the gill bars effect separation of the two cavities. As a result, there is leakage between them, which must cause a physiological disadvantage, but also correlates well with other primitive aspects of margaritiferine morphology, namely, the large foot and gaping valves.

The latter two features obviously are related, and they serve further to weaken the margaritiferine hydrodynamic system. On the other hand, the large foot helps in negotiating the gravels and rock interstices favored by margaritiferines. The apapillose character-state of the excurrent posterior mantle aperture is considered by us to be the primitive condition and perhaps correlates with a weak pumping system because papillae would impede exit of waste particles and larvae expelled by the weak excurrent stream.

By comparison to other unionid groups the Margaritiferinae are not very successful. They are holarctic with representation in southeast Asia. They have a fossil record extending from the upper Cretaceous (Haas, 1969b). However, they are few species (five or six), which apparently belong to only one genus. Most of the species are restricted to cool, highly oxygenated water and gravel or rocky substrate. The species are most frequently found in soft-water upland streams without other species of unionids.

The Anodontinae have some unique character-states. These complement any decision, based on whatever kind of evidence, that *Anodonta* and its kin are a distinct unionid group. The subfamily is holarctic in distribution, as is the Margaritiferinae. The widespread distribution patterns suggest that the two subfamilies predate some groups of the Ambleminae that are entirely restricted to

North America. The Anodontinae have had a far greater success than have the Margaritiferinae. The genus *Anodonta* is represented by several nominal subgenera (including, no doubt, at least some legitimate biological entities). The Nearctic is the area of greatest anodontine survival and speciation, as apparently is the case for the Margaritiferinae. The Anodontinae may have been successful elsewhere, as well, as is suggested by the great similarity of *Alasmidonta arcula* (Lea) of the Altamaha River, Georgia, U.S.A., to *Unio languilati* of China (see Johnson, 1970, and Heude, 1875).

The Anodontinae are similar (yet hardly identical) to the Margaritiferinae, but vastly different from other Nearctic Unionidae, in exhibiting almost no hitherto discernible generic differences of soft-tissue anatomy. Soft-tissue diversification has been the key to success of the Ambleminae, even though there have been some correlative conchological adjustments. However, evolution among the Anodontinae appears to have involved essentially only the shell. Accordingly, in North America (where genera that are morphologically anodontine are numerous) there exists a conchological range from the heavily hinged and completely dentate *Lasmigona complanata* through the paper-thin and edentulous *Anodonta imbecillis*. The genus *Alasmidonta* (perhaps including *Unio languilati*) and its complex of at least five nominal subgenera represent an intermediate step in this evolutionary progression. The conchological characters of this genus include pseudocardinal dentition and more or less well developed lateral teeth. Our point is that this group includes character variation that probably is too great to justify inclusion in a single genus. For example, one such species, *Alasmidonta (Prolasmidonta) heterodon* (Lea) recently had its subgenus (of which the species is Ortmann's (1914) monotype) raised to generic level (Fuller, 1977). The correct systematic placement of this species is most uncertain, but it remains symbolic of the difficulties in classifying morphologically equivocal animals whose genetic affinities have not been immunologically well established.

The conchological diversity and the soft-tissue conservatism of the Anodontinae have been reviewed. This peculiar combination of trends in characters probably justifies our suspicion that this subfamily's morphological features are mainly unique and war-

rant unusual taxonomic treatment. However, this standpoint does not exhaust the roster of anodontine peculiarities.

The modern Anodontinae are more species-rich and morphologically diversified than the modern Margaritiferinae, but this serves to dramatize the apparent pattern of anodontine differential extinction—or lack of initial success. Several of the Nearctic anodontine genera are monotypic, and the list probably will increase as a result of further research because some of the other genera have numerous monotypic nominal subgenera, some of which probably deserve generic rank. Only *Anodonta* itself has speciated with much success, and only this genus exhibits wide ecological and geographical ranges. Anodontine failure strengthens the supposition of the subfamily's antiquity and early derivation from other Unionidae.

Subtribal groups of Ambleminae: Lampsilini that are based on the longenous, ptychobranched, eschatogenous, and mesogenous marsupial types include only six genera, of which *Obliquaria* and *Dromus* are monotypic. *Cyprogenia*, *Frieronia*, and *Cyrtonaias* presently include at most two species each. These marsupial conditions and corresponding subtribes are not correlated with success as measured by large radiations of species or numerous genera. *Cyrtonaias tampicoensis* (Lea) and the monotype *Obliquaria reflexa* Rafinesque are successful in the Gulf of Mexico drainage of Texas and Mexico and in the Gulf drainage and the Mississippi River basin, respectively, but the other species of these groups probably never have had geographically successful ranges. More specifically, several of these species have been restricted to the Cumberlandian and/or Ozarkian faunas (see van der Schalie & van der Schalie, 1950). *Dromus* and *Cyprogenia* are limited to one or both biogeographical provinces. It probably is significant that the Longenae are geographically separated from the others of these unsuccessful groups.

The Heterogenae are successful. Their success correlates with the marsupial restriction to the posterior section of the demibranch (see p. 242). One quarter of the naiad species recognized as having invaded or reinvaded the Canadian interior basin since the most recent (Wisconsin) glaciation are heterogeneous Lampsilini (Clarke, 1973). As another example, the *Lampsilis radiata* complex probably is the geographically most widely ranging group of Nearctic naiades. In order to

accomplish its geographic range, the complex must have wide ecological tolerances, as well.

The Heterogenae include most of the genera of Lampsilini. However, even within this, the most specialized and by far the most successful Lampsilini group, there are different degrees of morphological development and of success. There is a morphological gradient corresponding to the joint theme of greatly reducing the amount of outer demibranch that is marsupial and of locating the marsupium at the posterior end of the demibranch.

The more specialized heterogeneous genera have a swollen reniform marsupium (when charged) in the postbasal corner of the outer demibranch. The nearby postbasal mantle margin is modified in various ways that serve as attractants for piscine hosts of unionid larvae. For example, the postbasal margins of *Lampsilis* are piscine in character; the implication is that predatory (or merely grazing) fish species will attack the "prey" represented by the mussel's mantle margins and will be showered with glochidia if, as is often true in the case of heterogeneous genera, discharge of parasitic larvae is through the marsupial wall and not through the excurrent mantle aperture.

These morphological adjustments have been accompanied by ethological adaptations, as well. For example, the female of some (perhaps all) *Lampsilis* is able to orient herself so that her marsupium's proximity to the host fish is optimized and the movement of her postbasal mantle margins (piscine flaps) are capable of attracting a host.

Whether or not all Lampsilini: Heterogenae can coordinate with potential hosts is not known, but complementary structural and behavioral strategies are clear. The incorporation of behavioral factors into the reproductive process not only probably is the key to the success of the Heterogenae, but also provides a key to classification of the group. The fact that the postbasal portion of the outer demibranch is marsupial defines this group, but there are other variables that are of use in classification, e.g. pigmentation, size and shape of the egg mass, and lamellar coverage of the egg mass.

An example of a problem in a classification that uses such characters is *Unio ochraceus* Say. This species was long classified as a *Lampsilis*, which it clearly is not, because it has no mantle flaps, as recognized by Morrison (1975), who considered this species a



*Leptodea*. Bereza & Fuller (1975) pointed out that the number and structure of the egg masses of this species are not similar to those of *Leptodea*. No one has yet proposed a generic name for this species.

As a group, however, the Heterogenae are character-poor. This not only has created taxonomic problems, but also makes tracing the group's radiation very difficult on morphological grounds alone. Nevertheless, immunological evidence is somewhat compensating.

### Zoogeography through time

The Unionacea are known with some degree of authority from the Triassic (review by Walker, 1910; Modell, 1942; Haas, 1969b). They are perhaps known from the upper Devonian (Smith, 1977). The Unionacea were widely spread in Pangaea; the presumably primitive family of Hyriidae of Australasia and western South America remained in Gondwanaland continents; the Unionidae, essentially in Laurasian continents. African Unionidae are either due to an original Gondwanaland stock or derived from a later invasion from Eurasia (see Heard, 1974).

The greatest diversity of naiades today is found in the Atlantic drainages of the Old and New Worlds. The implication is that the area of initial radiation of the ancestors of modern naiades lay in that portion of Pangaea where the Atlantic rift began in the Mesozoic. Whether or not the Unionacea (a nearly global group) and the Mutelacea (a Gondwanaland element) have a derivative relationship is unresolved, though not at issue here.

The essential identity of soft-tissue plan in all Unionacea suggests that a common stock existed in Pangaea. The acquisition of four or five derived morphological character-states separating the more specialized non-margaritiferine Unionidae from the Margaritiferinae must have occurred before the breakup of Pangaea, as is evidenced by the modern distribution of Margaritiferinae, Anodontinae, and African and Asian taxa related to North American Ambleminae.

The *Margaritifera* group is of Laurasian origin and has a modern relict distribution in Laos and the Holarctic. It is inconceivable that this ephemeral, at present largely unsuccessful group, confined essentially to uplands, could have achieved its present distribution entirely by post-Pangaeian land bridges. Walker (1910) argued persuasively that

*Margaritifera* evolved in Asia and reached western North America via the Bering land bridge in the Miocene or early Pliocene, and that *Margaritifera* reached eastern North America via the Greenland bridge. Pangaeian-Asian origin of *Margaritifera* subsequently affected by plate tectonics and dispersal over Pliocene to Pleistocene land bridges was endorsed by Smith (1977).

The Anodontinae, also, are Holarctic and confined to the northern hemisphere. Only *Anodonta* is known with certainty to be represented in Eurasia. There is a pronounced conchological similarity of certain Nearctic *Alasmidonta* to at least one species of eastern Asia, which accordingly is considered anodontine. The geographic distribution of Anodontinae is in Europe, Asia (Oriental zoogeographic province), and North America; this indicates a widespread Laurasian distribution.

The modern proliferation of anodontine genera is in North America. Only *Anodonta* is widespread, commonly encountered, species-rich, and biologically adaptable. There are at least three, chronologically differing interpretations of the occurrence of Eurasian *Anodonta* (or very similar forms): 1) The anodontine radiation, including *Anodonta*, was complete prior to the breakup of Laurasia; 2) the greatest anodontine cladogenesis occurred in North America, but *Anodonta* was widespread in Laurasia before North America separated from the pangaeian supercontinent; 3) *Anodonta* spread to Asia from eastern North America prior to the rise of the Rocky Mountains and subsidence of the Bering land bridge.

Walker (1910) considered Nearctic *Anodonta* of the Pacific drainage to be of Asiatic origin. Heard (1974) considered primitive progenitors of modern Anodontinae (e.g., *Strophitus*) to have originated in Asia and spread via the Bering land bridge into North America. Following Walker, it is highly probable that *Anodonta*, as ancient as *Margaritifera*, had its origin in the same pangaeian region as *Margaritifera*, and dispersed via the same general routes.

Some taxa in our Ambleminae questionably originated in the Triassic age and certainly existed in the Cretaceous. *Margaritifera* and the Anodontinae are known with certainty from the Cretaceous. Simpson (1896) noted a "remarkable similarity" between the unionid faunas of North America and southeastern Asia, plus the Tertiary faunas of both Europe

and Asia. Walker (1910) stated that there is "no doubt but that the characteristic (unionid) fauna of North America is descended from the Upper Cretaceous species, which then lived" in certain western U.S.A. states, as is evidenced by the fossil record. Walker (1910) noted the strong resemblance of Oriental Unionidae and those of North American Cretaceous to early Tertiary North American fossil unionids. Given the evidence, one reasonably assumes that the breakup of Pangaea did isolate a segment of early unionid stock in North America and that these isolates gave rise to most of the current endemic North American fauna. Only much later did some Asian stock reach western North America via the Bering bridge or eastern North America from Europe.

Members of the Ambleminae: Pleurobemini and Gonideini have morphological affinities to certain African and Eurasian taxa. These are reviewed by Heard & Guckert (1971) and Heard (1974); a few will be mentioned here. *Brazzaea anceyi* Bourguignat, of Africa, was grouped in the Gonideinae (Heard & Guckert, 1971) because it had been reported (Bloomer, 1931a) to be tetragenous, with distinct supra-anal opening, and with continuous, but

perforated septa. *Lamellidens marginalis* (Lamarck) from India is ectobranchous, yet with perforated septa (Bloomer, 1931b). Because tetragenous or ectobranchous taxa may occur in any tribe, we provisionally place this taxon in the Gonideini. Heard & Guckert listed several Southeast Asian taxa with perforated septa that they considered Amblemidae and we provisionally consider as Gonideini.

The tribe Lampsilini is uniquely North American and, with the possible exception of a morphologically somewhat Lampsilini element in the Pacific drainage (Dwight Taylor, personal communication), is entirely confined to the Atlantic drainages. It is probable that the Lampsilini radiation occurred only since the complete independence of North America. Of the five morphologically defined sub-Lampsilini groupings of taxa that have been proposed, four are comparative failures, but the fifth, the Heterogenae, dominates the entire Atlantic drainage faunas in terms of numbers of genera and species and in terms of ecological success. This great success is attributed to the sum of morphological character-states that are unique to the Lampsilini in general and to the Heterogenae in particular.

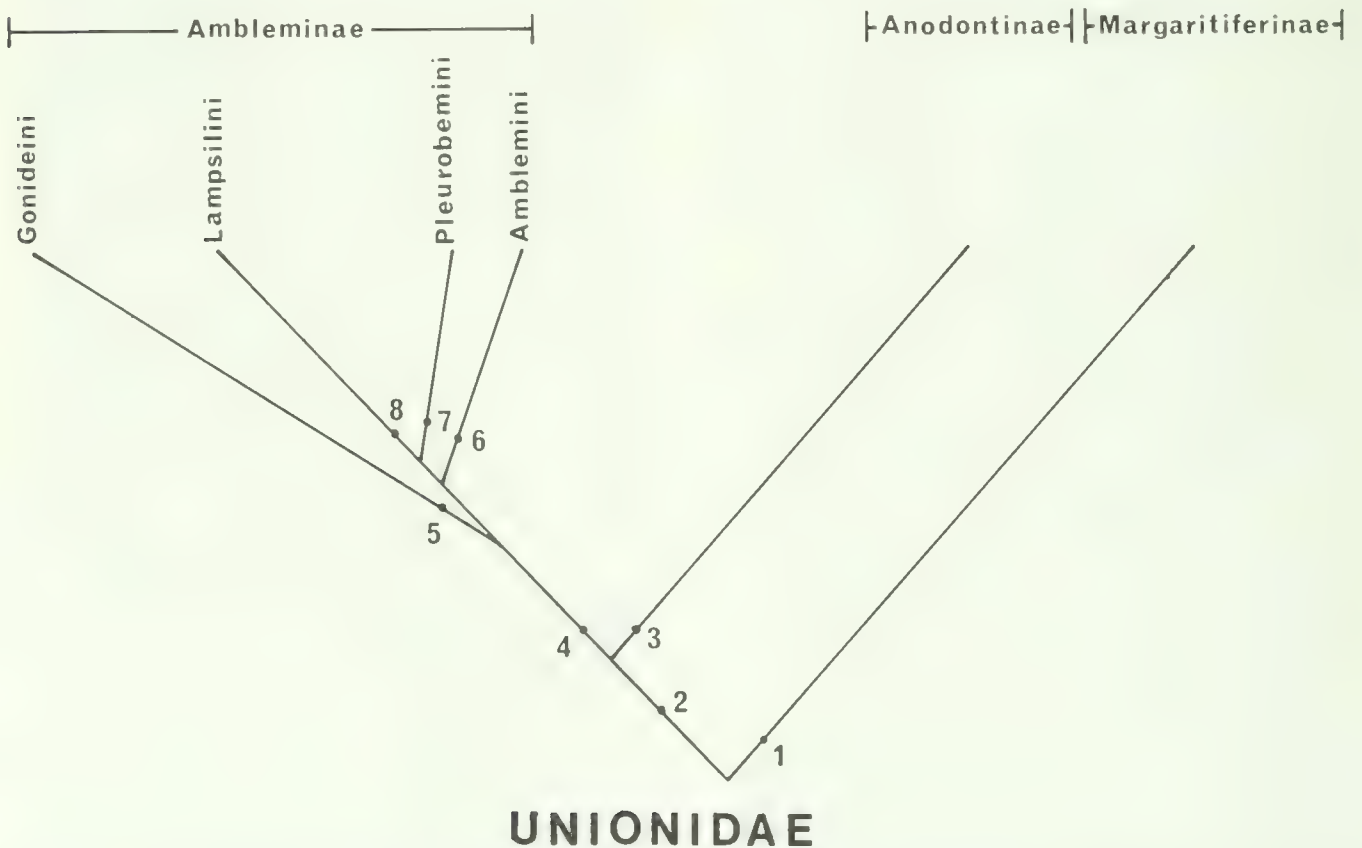

FIG. 4. Cladogram portraying relationships among unionid taxa. Numbered points are discussed in the text, p. 247.

## Cladistic relationships

A cladogram (Fig. 4) was constructed on the basis of our immunological results, morphology, the fossil record, and zoogeography. As implied by the cladogram, there was divergence within proto-unionid stock before Gondwanaland split up in the late Mesozoic. The proto-unionid stock would have had the generalized, *Margaritifera*-type anatomy and would have been tetragenous. Divergence gave rise to proto-*Margaritifera* (point 1, Fig. 4) and to a lineage that gained some morphological advances, i.e. development of septa and water tubes parallel to the gill filaments, creation of the diaphragm and supra-anal aperture. The septa probably were perforated (point 2, Fig. 4).

The unionids with these derived morphological character-states diverged before Gondwanaland split up and yielded yet again two lineages. One of these, the proto-Anodontinae (point 3, Fig. 4), developed tripartite water tubes, became ectobranchous, and developed hooks on the glochidia. One eventual taxon (*Strophitus*) retained perforated septa.

The other lineage (point 4, Fig. 4) remained tetragenous and had undivided water tubes with hookless glochidia and perforated septa. This lineage diverged, yielding proto-Gonideini (point 5, Fig. 4) prior to the breakup of Pangaea. This clade is primarily tetragenous and has perforated septa.

There was, also, rapid divergence that formed the lineages of the 1) proto-Amblemini (point 6, Fig. 4), where the taxa are primarily tetragenous, one species group has perforated septa, and several species have arborescent incurrent papillae, as in the Margaritiferinae and the lineage of the 2) Pleurobemini (point 7, Fig. 4), where the taxa primarily are ectobranchous, without perforated septa, and without arborescent papillae.

Last, the proto-Lampsilini (point 8, Fig. 4) evolved; they are uniquely North American, totally ectobranchous, and with the most specialized character-states of marsupial development and mantle modifications.

The cladogram is consistent with the ordination diagrams based on immunological data given in Figs. 2, 3.

## ACKNOWLEDGEMENTS

We acknowledge with great thanks the technical assistance of Mrs. Caryl Hesterman. We thank Dr. William H. Heard, Mr. Daniel J.

Bereza, Mr. Malcolm F. Vidrine, and Dr. Dwight Taylor for supplying us with various populations of clams. Mrs. Harriet Davis and Ms. Karen Snow, also, provided technical assistance. We especially acknowledge Dr. Wayne Moss for his help in the initial stages of the multivariate analyses.

## LITERATURE CITED

- BAKER, F. C., 1928, The freshwater Mollusca of Wisconsin. Part II. Pelecypoda. *Wisconsin Geological and Natural History Survey Bulletin* 70(2): 495 p., 53 pl.
- BASHFORD, N. L., BUTLER, J. E., LEONE, C. A. & ROHLF, F. J., 1968, Immunological comparisons of selected Coleoptera with analyses of relationships using numerical taxonomic methods. *Systematic Zoology*, 17: 388–406.
- BEREZA, D. J. & FULLER, S. L. H., 1975, Notes on "*Lampsilis*" *ochracea* (Say) (Mollusca: Bivalvia). *ASB [Association of Southeastern Biologists] Bulletin*, 22(2): 42.
- BLOOMER, H. H., 1931a, On the anatomy of *Brazzaea anceyi* Bourguignat. *Proceedings of the Malacological Society of London*, 19: 228–233.
- BLOOMER, H. H., 1931b, A note on the anatomy of *Lamellidens marginalis*, Lamarck and *L. thwaitesii*, Lea. *Proceedings of the Malacological Society of London*, 19: 270–272.
- BURCH, J. B., 1973, Freshwater Unionacean clams (Mollusca: Pelecypoda) of North America. United States Environmental Protection Agency. *Biota of Freshwater Ecosystems; Identification Manual* 11, 176 p.
- BURCH, J. B., 1975, *Freshwater unionacean clams (Mollusca: Pelecypoda) of North America*. Revised Ed. Malacological Publications, Hamburg, Michigan, 204 p.
- CLARKE, A. H., 1973, The freshwater mollusks of the Canadian interior basin. *Malacologia*, 13: 1–509.
- CONRAD, T. A., 1834, *New fresh water shells of the United States with colored illustrations, and a monograph of the genus Anculotus of Say; also a Synopsis of the American naiades*. Philadelphia, Pennsylvania, p. 1–76.
- DAUGHADY, W. H., LOWRY, O., ROSEBROUGH, N. & FIELDS, W., 1952, Determination of cerebrospinal fluid proteins with the folin phenol reagent. *Journal of Laboratory and Clinical Medicine*, 39: 663–665.
- DAVIS, G. M., 1969, Electrophoretic, immunological, and biological properties of a population of *Semisulcospira* transmitting *Paragonimus westermani* in Japan. *Japanese Journal of Parasitology*, 18: 93–119.
- DAVIS, G. M., 1978, Experimental methods in molluscan systematics. In: FRETTER, V. & PEAKE, J., eds., *Pulmonates*, Vol. 2A: 99–169. Academic Press, London.

- DAVIS, G. M., 1979, The origin and evolution of the gastropod family Pomatiopsidae, with emphasis on the Mekong River Triculinae. *Academy of Natural Sciences of Philadelphia Monograph* 20: i-ix, 1-120.
- DAVIS, G. M., FULLER, S. L. H. & HESTERMAN, C., 1978, Toward a definitive higher classification of North American Unionacea. *Bulletin of the American Malacological Union, Inc.*, for 1977, p. 85 (abstract).
- DAVIS, G. M., HEARD, W., FULLER, S. L. H. & HESTERMAN, C., 1981, Molecular genetics and speciation in *Elliptio*, and its relationships to other taxa of North American Unionidae (Bivalvia). *Biological Journal of the Linnean Society of London* (in press).
- DAVIS, G. M. & SUZUKI, S., 1971, Mouse ascites fluid as a source of antibody against molluscan antigens. *Veliger*, 13: 207-225.
- FITCH, W. M., 1976, Molecular evolutionary clocks. In: AYALA, J., ed., *Molecular Evolution*. Sinauer, Sunderland, Massachusetts, U.S.A., p. 160-178.
- FRETTER, V. & GRAHAM, A., 1962, *British Prosobranch Molluscs*. Ray Society, London, p. xvi, 1-755.
- FRIERSON, L. S., 1927, *A classification and annotated check list of the North American naiades*. Baylor University Press, Waco, Texas, 111 p.
- FULLER, S. L. H., 1974 [1973], *Fusconaia masoni*; (Conrad 1834) (Bivalvia: Unionacea) in the Atlantic drainage of the southeastern United States. *Malacological Review*, 6: 105-117.
- FULLER, S. L. H., 1975, The systematic position of *Cyrtoneias* (Bivalvia: Unionidae). *Malacological Review*, 8: 81-89.
- FULLER, S. L. H., 1977, Freshwater and terrestrial mollusks, p. 143-194. In: COOPER, J. E., ROBINSON, S. S. & FUNDERBURG, J. B., eds., *Endangered and Threatened Plants and Animals of North Carolina*. North Carolina State Museum of Natural History, Raleigh, p. 1-444.
- HAAS, F., 1969a, Superfamilia: Unionacea. In: *Das Tierreich. Eine Zusammenstellung und Kennzeichnung der resenten Tierformen*. Lief. 88: i-x, 1-663. de Gruyter, Berlin.
- HAAS, F., 1969b, Superfamily Unionacea. In: *Treatise on Invertebrate Paleontology*. MOORE, R. C., ed. Part N, Mollusca, 6: Vol. 1 (of 3): Bivalvia, Unionacea, p. N411-N470.
- HANNIBAL, H., 1912, A synopsis of the Recent and Tertiary freshwater Mollusca of the California Province, based upon an ontogenic classification. *Proceedings of the Malacological Society of London*, 10: 112-211, pl. 5-8.
- HEARD, W. H., 1974, Anatomical systematics of freshwater mussels. *Malacological Review*, 7: 41-42.
- HEARD, W. H., 1975, Sexuality and other aspects of reproduction in *Anodonta* (Pelecypoda: Unionidae). *Malacologia*, 15: 81-103.
- HEARD, W. H. & GUCKERT, R. H., 1971 [1970], A re-evaluation of the recent Unionacea (Pelecypoda) of North America. *Malacologia*, 10: 333-355.
- HEARD, W. H. & VAIL, V. A., 1976, The systematic position of *Unio caffer* (Pelecypoda: Unionoida: Unionidae). *Zoologica Africana*, 11: 45-58.
- HEUDE, P. M., 1875, *Conchyliologie fluviatile de la province de Nanking*. Paris, Savy, pt. 1, pl. 1-8.
- HOAGLAND, K. E., 1975, *Reproductive strategies and evolution in the genus Crepidula* (Gastropoda: Calyptraeidae). Unpubl. Ph.D. thesis, Harvard Univ.
- JOHNSON, R. I., 1970, The systematics and zoogeography of the Unionidae (Mollusca: Bivalvia) of the southern Atlantic slope region. *Bulletin of the Museum of Comparative Zoology*, 140: 263-450.
- KING, M. C. & WILSON, A. C., 1975, Evolution at two levels in humans and chimpanzees. *Science*, 188: 107-116.
- KRUSKAL, J. B., 1964, Multidimensional scaling by optimizing goodness of fit to a nonmetric hypothesis. *Psychometrika*, 22: 1-27.
- LEA, I., 1858, Descriptions of embryonic forms of thirty-eight species of Unionidae. *Journal of the Academy of Natural Sciences of Philadelphia*, 4: 43-50.
- LEA, I., 1863, Descriptions of the soft parts of one hundred and forty-three species and some embryonic forms of Unionidae. *Journal of the Academy of Natural Sciences of Philadelphia*, 5: 401-446.
- MAINARDI, D., 1959, Immunological distance among some gallinaceous birds. *Nature*, 184: 913-914.
- MODELL, H., 1942, Das natürliche System der Najaden. *Archiv für Molluskenkunde*, 74: 161-191.
- MODELL, H., 1949, Das natürliche System der Najaden. 2. *Archiv für Molluskenkunde*, 78: 29-48.
- MODELL, H., 1964, Das natürliche System der Najaden. *Archiv für Molluskenkunde*, 93: 71-126.
- MORRISON, J. P. E., 1955, Family relationships in the North American freshwater mussels. *American Malacological Union Annual Reports*, 1955: 16-17.
- MORRISON, J. P. E., 1975, Maryland and Virginia mussels of Lister. *Bulletin of the American Malacological Union*, 1974, p. 36-39.
- MORTON, J. E., 1971, *Molluscs*. Hutchinson, London, 244 p.
- ORTMANN, A., 1910a, A new system of the Unionidae. *Nautilus*, 23: 114-120.
- ORTMANN, A. E., 1910b, The marsupium of the Anodontinae. *Biological Bulletin*, 19(3): 217.
- ORTMANN, A. E., 1911, A monograph of the naiades of Pennsylvania [Parts I, II]. *Memoirs of the Carnegie Museum*, 4: 279-347, pl. 80-89.
- ORTMANN, A. E., 1912a, *Cumberlandia*, a new genus of naiades. *Nautilus*, 26: 13-14.
- ORTMANN, A. E., 1912b, Notes upon the families

and genera of the naiades. *Annals of the Carnegie Museum*, 8: 222–365, pl. 18–20.

ORTMANN, A. E., 1914, Studies in naiades. *Nautilus*, 28: 41–47.

ORTMANN, A. E., 1916, The anatomical structure of *Gonidea angulata* (Lea). *Nautilus*, 30: 50–53.

ORTMANN, A. E., 1919, A monograph of the naiades of Pennsylvania. Part III. Systematic account of the genera and species. *Memoirs of the Carnegie Museum*, 8: 1–384, 21 pl.

ROHLF, F. J., 1970, Adaptive hierarchical clustering schemes. *Systematic Zoology*, 19: 58–82.

ROHLF, E. J., KISHPAUGH, J. & KIRK, D., 1972, *NT-SYS; Numerical Taxonomy System of Multivariate Statistical Programs*. State University of New York, Stony Brook, N.Y.

SARICH, V. M., 1977, Rates, sample sizes, and the neutrality hypothesis for electrophoresis in evolutionary studies. *Nature*, 265: 24–28.

SCHALIE, H. VAN DER & SCHALIE, A. VAN DER, 1950, The mussels of the Mississippi River. *American Midland Naturalist*, 44: 448–466.

SIMPSON, C. T., 1896, The classification and geographical distribution of the pearly fresh-water mussels. *Proceedings of the United States National Museum*, 18: 295–343.

SIMPSON, C. T., 1900, Synopsis of the naiades, or pearly fresh-water mussels. *Proceedings of the United States National Museum*, 22: 501–1044.

SIMPSON, C. T., 1914, *A descriptive catalogue of the naiades or pearly freshwater mussels*. Privately published by Bryant Walker, Detroit, Michigan, xi, 1540 p.

SMITH, D.G., 1977, The distribution of the Margaritiferidae: a review and a new synthesis. *Bulletin of the American Malacological Union*, Inc. for 1976, p. 42.

STANLEY, S., 1979, *Macroevolution*. Freeman, San Francisco, 132 p.

STERKI, V., 1898, Some observations on the genital organs of Unionidae, with reference to classification. *Nautilus*, 12: 18–21, 28–32.

STERKI, V., 1903, Notes on the Unionidae and their classification. *American Naturalist*, 37: 103–113.

WALKER, B., 1910, The distribution of *Margaritana margaritifera* (Linn.) in North America. *Proceedings of the Malacological Society of London*, 9: 126–145, pl. 2.

WEBSTER, R., 1975, Intuition and rational choice in the application of mathematics to soil systematics. *Soil Science*, 119: 394–404.

YONGE, C. M. & THOMPSON, T. E., 1976, *Living Marine Molluscs*. Collins, London, 288 p.

APPENDIX 1. A list of some important unionacean classifications. Note the profound influence of Ortmann's work on most subsequent systems.

Simpson (1900, 1914)	Ortmann (1910a, 1911, 1916)	Hannibal (1912)
Unionidae	Margaritiferidae	Margaritiferidae
Unioninae	Unionidae	Unionidae
Heterogenae	Gonideinae	Unioninae
Digenae	Unioninae	Anodontinae
Mesogenae	Anodontinae	Lampsilidae
Ptychogenae	Lampsilinae	Lampsilinae
Eschatigenae		Propterinae
Diagenae		Quadrulidae
Homogenae		Quadrulinae
Tetragenae		Pleurobeminae
Frierson (1927)	Modell (1942, 1949, 1964)	Morrison (1955)
Unionidae	Margaritiferidae	Margaritiferidae
Margaritiferinae	Margaritiferinae	Unionidae
Unioninae	Unionidae	Unioninae
Alasmidontinae	Quadrulinae	Alasmidontinae
Anodontinae	Rectidentinae	Anodontinae
Lampsilinae	Anodontinae	Amblemidae
	Elliptionidae	Ambleminae
	Pleurobeminae	Lampsilinae
	Elliptioninae	
	Alasmidontinae	
	Ambleminae	
	Lampsilinae	

## APPENDIX 1. (Continued)

Haas (1969a,b)	Heard & Guckert (1971)	Clarke (1973)
Margaritiferidae	Margaritiferidae	Margaritiferidae
Unionidae	Margaritiferinae	Unionidae
Unioninae	Cumberlandiinae	Ambleminae
Quadrulinae	Unionidae	Anodontinae
Alasmidontinae	Unioninae	Alasmidontini
Anodontinae	Pleurobeminae	Anodontini
Lampsilinae	Popenaiadinae	Lampsilinae
	Anodontinae	
	Lampsilinae	
	Amblemidae	
	Gonideinae	
	Ambleminae	
	Megalonaiadinae	
Davis et al. (1978)		Davis & Fuller (this study)
Unionidae		Unionidae
Margaritiferinae		Margaritiferinae
Anodontinae		Anodontinae
Lampsilinae		Ambleminae
Lampsilini		Lampsilini
Gonideini		Gonideini
Elliptionini		Pleurobemini
Amblemini		Amblemini

## APPENDIX 2. Annotations.

1. *Fusconaia ebena* (Lea)

Shells of the species that we call *F. ebena* conform to the type-concept of *F. ebena*. We cannot, at this time, explain the close relationship of this species to *Lampsilis* (Fig. 3). We must obtain fresh *F. ebena*, examine the anatomy, and retest the relationship. We suspect either experimental error in this case or a species with *Lampsilini* anatomy within a *Fusconaia*-appearing shell.

2. *Uniomerus*

In the first analysis of taxa here relegated to the Ambleminae (matrix of 15 antisera  $\times$  41 sets of antigens), *Uniomerus tetralasmus* was linked by the minimum spanning tree to *Quincuncina infucata* (see annotation no. 3). Because we were missing 46.6% of the data for *Q. infucata* in the matrix of cross comparisons, we reran the analysis without the data for *Q. infucata*. We had anti-*Q. infucata* antisera and data for all but three comparisons

(no data for *Leptodea fragilis*, *Villosa delumbis*, *Elliptio buckleyi*).

In the reanalysis (15  $\times$  40 matrix), *U. tetralasmus* was, on examination of the matrix of distance coefficients, most clearly related to 1) *Elliptio buckleyi* (.749), 2) *E. complanata* (.893), and 3) *Fusconaia flava* (.982). On this basis *Uniomerus* is classified as a genus of the tribe Pleurobemini.

3. *Quincuncina*

We did not have data for 7 of the 15 comparisons of the matrix of 15 antisera  $\times$  41 sets of antigens (OTUs). Given this lack of data, the closest relationships seen in the matrix of taxonomic distances were: *Elliptio crassidens* (.726), *Leptodea fragilis* (.786), *Elliptio lanceolata* (.891), *Tritogonia verrucosa* (.895), *Quadrula apiculata* (.896). The minimum spanning tree showed connections of *L. fragilis*, *E. crassidens*, *U. tetralasmus*, and *Q. apiculata* to all other taxa in the Amblemini and through *L. fragilis* to all other taxa in the *Lampsilini*.

The net result indicates that *Quincuncina*

should be provisionally placed in the Amblemini. Verification of this placement is dependent on filling in the missing data permitting a more precise analysis of relationships. The placement in the Amblemini agrees with the grouping of genera in the Ambleminae sensu Heard & Guckert (1971) if one excludes *Fusconaia* (we have no data for *Elliptoideus*) but includes *Megaloniaias* which does not deserve separate ranking in a subfamily (Megaloniaiadae).

#### 4. Hooked glochidia

There are two types of hooked glochidia. The large single pair of hooks at the periphery of the glochidial shells of Anodontinae are not homologous with the two pairs of hooks, one pair at each side of the glochidial shells of *Proptera*. The hook morphology is quite different in the two taxa.

#### 5. Glochidium size

We used a glochidial index (Gln) for size, where the Gln = the height of the glochidium (H<sub>mm</sub>) × the length of the glochidium (L<sub>mm</sub>). The glochidium of the Margaritiferinae is small (Ortmann, 1911; Baker, 1928). "Small" is defined as Gln = < .0036. The glochidia of the Anodontinae are "large": the average Gln = about 0.1000. The range is from 0.078 in *Alasmidonta* to 0.1225 in *Anodonta corpulenta*. Most species have a Gln > 0.0900. The glochidia of the Ambleminae are "medium" sized where the average Gln = about 0.047. The smallest was that of *Quadrula quadrula* (Gln = 0.007; note that Gln of *Q. pustulosa* was 0.0736); the largest was that of *Cycloniaias tuberculata* (Gln = 0.0867). Most had a Gln between 0.02 and 0.06 (16 of 24 = 66.7%). None was as small as seen in the Margaritiferinae; only two species (8%) had a glochidium size as large as the smallest glochidium size of the Anodontinae (*Cycloniaias tuberculata* and *Megaloniaias gigantea* of our Amblemini).

#### 6. Change in nomenclature

Lampsilinae was changed to Ambleminae; Elliptionini was changed to Pleurobemini for reasons of nomenclatural priority (see Heard & Guckert, 1971, and Haas, 1969a,b).

APPENDIX 3. Glossary of terms. In the following definitions the noun is followed by its adjective in parentheses.

*Bradytixis (bradytictic)*: long term breeder; retains larvae in demibranchs except in Nearctic summer.

*Diagenae (diagenous)*: ectobranchous group whose ovisacs are transverse to the demibranchs (only in *Strophitus* of Anodontinae).

*Digenae (digenous)*: ectobranchous; two outer demibranchs are marsupial.

*Ectobranch (ectobranchous)*: digenous; defined above.

*Eschatigenae (eschatigenous)*: sub-tribal taxon of Lampsilini where the lower part of the posterior region of the demibranch is marsupial. Demibranch not folded; eschatigenous state.

*Heterogenae (heterogenous)*: subtribal taxon of Lampsilini where the posterior section of the demibranch is marsupial; heterogenous state.

*Homogenae (homogenous)*: entire outer demibranch loads with glochidia forming a smooth pad; Anodontinae; Ambleminae, Gonideini, Pleurobemini, Amblemini, and Lampsilini: Longenae (in part).

*Longenae (longenous)*: subtribal taxon of Lampsilini where the lower region of the demibranch is marsupial; longenous state.

*Mesogenae (mesogenous)*: sub-tribal taxon of the Lampsilini where the middle section of the demibranch is marsupial.

*Ptychogenae (ptychogenous)*: sub-tribal taxon of the Lampsilini where the lower part of outer demibranch is marsupial and folded.

*Tachytixis (tachytictic)*: short-term breeder; retains larvae in demibranchs only in Nearctic summer.

*Tetragenae (tetragenous)*: four demibranchs are marsupial and homogenous.

APPENDIX 4. Historical account of unionid classification.

One should consult Heard & Guckert (1971) for additional historical information.

Lea (1858, 1863), although using an erroneous and simplistic classification of his own devising, nevertheless wrote and illustrated many soft-tissue descriptions and thus was

the first to develop this category of data. Had Lea not overlooked the possibility that his observations could be applied to a revolutionary new type of classification, he might have become *the* important figure in the history of naiad systematics; instead, that mantle eventually fell to Simpson and ultimately to Ortmann. Sterki (1898, 1903) partly succeeded where Lea had missed his opportunity; he recognized that soft-tissue characters could be important in unionid classification, but he did not exploit this realization, perhaps because of his greater interest in the Sphaeriidae. He indicated that unionids should be classified on the basis of characters involving reproductive structures such as the marsupial demibranchs, the specialized marsupial areas of some demibranchs, the glochidial morphology, and duration of breeding season.

Simpson (1900, 1914) published not only the first comprehensive account of global naiad systematics, but also the first naiad classification that purposely incorporated soft-tissue data. Moreover, his classification arranged taxa according to marsupial characters, thus preparing the way for more sophisticated work by Ortmann. Finally, Simpson's work is especially important for our study because so many of his observations (some of them unique and no longer replicable because of extinction) concern Nearctic unionids. Simpson's works not only were prodigious, but also marked the turning point in the history of studying freshwater mussels. They pointed the way from totally inadequate 19th century conchological schemes towards Ortmann's future classifications.

Simpson's classification involved a single family and subfamily (Unionidae: Unioninae for Nearctic naiades), plus numerous further subdivisions, of the same rank, which today can be construed as tribes. The great weakness of the classification is that it is primarily monothetic, based on where the gills are loaded with glochidia in gravid females, and that his goal was a utilitarian classification. For example, Simpson (1900, 1914) was aware of the essential morphological peculiarities of the Margaritiferinae, but classified them in his tribe "Homogenae" with all other naiades of his acquaintance that exhibit a marsupium occupying the entirety of the outer demibranch.

Ortmann (1910a) was the first to ask fundamental questions about how the organisms related to themselves and to their environ-

ments. He was the first to make a synthesis of all data available while questioning how morphological structure related to function. He integrated data from shell, soft tissues, behavior, and environments. His result (1910a) was an original classification of one family and three subfamilies (Unionidae: Margaritiferinae [= Margaritaninae in those days], Unioninae, Lampsilinae). Subsequently, Ortmann (1911) raised his "Margaritaninae" to family rank and (1916) created another unionid subfamily, Gonideinae, for *Gonidea angulata* (Lea) of the Pacific drainage of North America. These were Ortmann's last (and only) changes of family-group taxa in comparison to his (1910a) original scheme.

Ortmann correctly interpreted the unique morphological character-states that set apart the higher taxa that include the groups of 1) *Margaritifera*, 2) *Anodonta*, 3) *Lampsilis*, 4) *Gonidea*. His grouping in the Unioninae (our Pleurobemini and Amblemini) included taxa with four as well as two marsupial demibranchs. The marsupium is not confined to restricted region of the gills as in his Lampsilinae, and taxa do not have unique mantle structures below the branchial openings as in many Lampsilinae. It is with Ortmann's Unioninae that we find, as did Heard & Guckert (1971), need for re-evaluation.

Most subsequent classifications involve alternate interpretations of the groups of *Lampsilis* and *Anodonta*. Hannibal (1912) recognized four families of Nearctic naiades (Appendix 1). His Unionidae is a partial subscription to Simpson's Homogenae; the marsupia in his subfamilies Unioninae and Anodontinae are homogeneous. His Unioninae comprise taxa in our Ambleminae: Pleurobemini (partim); his Anodontinae essentially are Ortmann's and ours. His Lampsilidae are our Ambleminae: Lampsilini. He created a subfamily for *Proptera*, presumably because of that genus' "ax-head" shaped glochidium. His Quadrulidae equals our Amblemini (partim) and Pleurobemini (partim). His Quadrulinae probably equals our Amblemini; his Pleurobeminae, our Pleurobemini (partim).

In summary of Hannibal's contribution, he anticipated our division of Ortmann's Unioninae into distinct groups of Pleurobemini and Amblemini. Overall, however, his system is one of gross taxonomic inflation. For example, there is no justification for a higher category based on *Proptera* (Fig. 3).

Frierson (1927) divided the Nearctic



Unionidae into five subfamilies. Only two items of his arrangement differ significantly from ours. His Unioninae is that of Ortmann and depends on the Eurasian concept of *Unio*. As Heard & Guckert (1971) have shown, this concept does not adequately accommodate the relevant New World naiades, which we interpret as the tribes Amblemini and Pleurobemini. Our second objection to Frierson's arrangement is his Alasmidontinae. We consider the relevant genera as evolutionary stages within a single subfamily Anodontinae (Fig. 2).

Modell (1942, 1949, 1964) is an atavism to 19th century conchology. He created a highly controversial scheme that is monothetic, i.e. based almost solely upon a single discriminant, beak sculpture. Heard & Guckert (1971) have fully discussed the artificiality of the Modell classification. Remarkably, our Anodontinae, which we seemingly rightly regard as an integrated group both morphologically and immunologically are distributed by Modell between two families and subfamilies, the Unionidae: Anodontinae and the Elliptionidae: Alasmidontinae. We reject

Modell's classification.

Morrison's (1955) classification is primarily based on the monothetic notion that the nature of the glochidial shell is the key to naiad classification. He opted for a three-family arrangement (Appendix 1). The Unionidae are taxa with hooked glochidia and divided into three subfamilies: Alasmidontinae, Anodontinae, Unioninae. Morrison's Amblemidae (our tribes Amblemini, Pleurobemini, Lampsilini) are equal to our Ambleminae minus *Gonidea*; his Amblemini are, excepting the European *Unio*, equal to Ortmann's Unioninae.

Morrison's classification is rejected because it is taxonomically inflated, separates morphologically and immunologically allied groups, exhibits the problems of a classification based on monothetic concepts, and, as in many of his published ideas about naiades, is supported by little or no evidence. His work is, however, laudable because very often he employed ecological information in framing his ideas.

Haas (1969a) and Clarke (1973) published classifications that are essentially rearrangements of Morrison's (1955).



## INTERPOPULATION VARIATION IN CALCAREOUS AND PROTEINACEOUS SHELL COMPONENTS IN THE STREAM LIMPET, *FERRISSIA RIVULARIS*<sup>1</sup>

W. D. Russell-Hunter, Albert J. Burky<sup>2</sup> and R. Douglas Hunter<sup>3</sup>

*Department of Biology, Syracuse University, Syracuse, New York 13210, U.S.A.; and the Marine Biological Laboratory, Woods Hole, Massachusetts 02543, U.S.A.*

### ABSTRACT

Ten natural populations of the North American stream limpet, *Ferrissia rivularis*, were studied in upstate New York, in a set of localities whose waters have a 15-fold range of dissolved calcium (4.6 to 67.6 mg/liter) and also range from oligotrophy to eutrophy.

Shell component analyses (calcium carbonate, total organic carbon, and total nitrogen) are reported both as component mass-fractions (mg/g or  $\mu\text{g/g}$  dry weight) and as values for a "standard limpet" shell of 3.5 mm aperture length (AL). More than twofold differences occur between populations in all three components, with relatively little variation occurring within each population. Expressed "per standard limpet,"  $\text{CaCO}_3$  values for different populations range from 0.8 to 1.97 mg with no direct relationship to environmental dissolved calcium. Nominal "concentration ratios" of body calcium to environmental calcium range from 1,953:1 to 29,130:1. Values for total organic carbon (9.13 to 21.0  $\mu\text{g}$ ) and total nitrogen (2.7 to 6.69  $\mu\text{g}$ ) in the shells parallel each other, all C:N ratios being relatively uniform (3.0:1 to 3.4:1), and indicating that the non-calcareous components are largely proteinaceous. Although alternative hypotheses predict an inverse or a direct relationship between the organic and the calcareous components, neither is shown by these populations.

It appears that genetic controls of shell secretion for the two major components are independent, and that chance dispersal has resulted in some "rather inappropriate shells in certain habitats." This irregular variation in *Ferrissia* is first discussed in relation to other patterns of shell component relationships known for other freshwater molluscs, including direct relationship of the mass of shell calcium carbonate to the dissolved calcium available as in *Lymnaea peregra* and *Laevapex fuscus* and the apparent "regulation" producing standard shell weights in *Lymnaea palustris* and *Physa gyrina*. The results are then discussed in relation to assessment of radionuclide pollution using molluscan shells from fresh waters and in their more general relationship to modes and rates of evolutionary change in freshwater faunas.

### INTRODUCTION

Natural populations of freshwater pulmonate snails show extensive infraspecific physiological variation between populations (Russell-Hunter, 1964, 1978). Aspects of this in growth, fecundity and respiration have been reported (Burky, 1970, 1971; Hunter, 1975a, b; McMahan, 1973, 1975a, b; Russell-Hunter, 1953, 1961, 1964) and its evolutionary significance discussed (Russell-Hunter, 1964, 1978). There can also be interpopulation variations in shell components in several species, and the present report concerns these in the freshwater limpet, *Ferrissia rivularis* (Say).

In freshwater pulmonates—as in the majority of molluscs—the secreted shells have two principal components: a meshwork of protein fibers (the organic matrix) and crystalline calcium carbonate (Degens, Spencer & Parker, 1967; Jones, 1969; Russell-Hunter, Meadows, Apley & Burky, 1968; Russell-Hunter, Burky & Hunter, 1970). The latter is secreted in greater part after active uptake directly from environmental water, and in a lesser fraction after assimilation from food. In the euryoecic species, *Lymnaea peregra*, the thickness (and mass) of the calcareous shell varies with the calcium available in the waters (Hubendick, 1947; Russell-Hunter, Burky & Hunter, 1970). Thus, it appears that *Lymnaea peregra* ex-

<sup>1</sup>This investigation was supported by National Science Foundation research grants GB-36757, and DEB-7810190 to Dr. W. D. Russell-Hunter.

<sup>2</sup>Present address: Department of Biology, University of Dayton, Dayton, Ohio 45409.

<sup>3</sup>Present address: Department of Biological Sciences, Oakland University, Rochester, Michigan 48063.

depends about the same energy on shell-making no matter what the environmental hardness. A second pattern found in *Lymnaea palustris* (Hunter, 1975b) and in *Physa gyrina* (Hunter & Lull, 1977) involves somewhat more "regulation": over a considerable range of environmental calcium values, populations have shells of approximately "standard" weight at all growth stages. The case of the stream limpet, *Ferrissia rivularis*, in natural creek populations of upstate New York is strikingly different from both of these patterns. Although these creek waters vary over 15-fold in dissolved calcium, the highly significant differences in shell calcium found to exist between populations are not correlated (Russell-Hunter, Apley, Burky & Meadows, 1967; Russell-Hunter, Burky & Hunter, 1970). Anabolic concentration ratios appeared to range from 1,609:1 to 10,615:1 and there was other circumstantial evidence of physiological races. These data on shell calcium content (for limpets from six creeks and one lake) reported in these two earlier notes require some correction, as a result of the improved methods described below, but the significant differences and lack of environmental correlation remain as claimed. More recently, we have measured total organic carbon and total nitrogen in shells of limpet growth stages from ten natural populations, and published a preliminary abstract on seven of them (Russell-Hunter, Burky & Hunter, 1970). Subsequently, the shell calcium content for the same ten populations was redetermined. We now report environmental water conditions and the calcium, organic carbon and nitrogen contents of limpet shells for nine creeks and for Oneida Lake. After computing these values in terms of "standard" limpets to allow more direct comparisons, we discuss several hypothetical relationships which might be expected to affect variation in shell components, compare the available data for other species, and end by briefly reviewing the nature and significance of this kind of interpopulation physiological variation in freshwater molluscs.

#### MATERIALS AND METHODS

The freshwater basommatophoran limpet, *Ferrissia rivularis* (Say), is ubiquitous in appropriate stream habitats in northeastern North America. In upstate New York, this species lives in waters ranging in calcium content from 4.6 to 67.6 mg per liter (total hardness

values range from 25 to 243 mg calcium carbonate per liter), and we have collected regular population samples for other biometric studies from 53 localities. The ten localities providing populations of limpets for the present study are (in order of decreasing hardness): Limestone Creek (LC) near Manlius, Canandaigua Outlet (CO) at Alloway, Chittenango Creek (CC) at Cazenovia, a section of the shore of Oneida Lake (OL) at Shackleton's Point, Chenango River (CR) at Randallsville, Big Bay Creek (BBC) near Central Square, Fish Creek (FC) below Westvale, Slocum Creek (SC) at West Monroe, Black Creek (BC) above Cleveland, and Morgan's Hill Creek (MHC) near Truxton. All of these localities are in the central or "upstate" section of New York State (exact latitudes, longitudes, quadrangles and county references can be provided on request). CR and MHC are in the drainage system of the Susquehanna River which eventually empties into Chesapeake Bay. The waters at CO drain into the Clyde division, and LC, CC, BC, FC, SC, BBC and Oneida Lake (OL) itself into the Oneida division, of the Seneca-Clyde-Oneida drainage which passes by way of the Oswego River into Lake Ontario and then on to the St. Lawrence.

The environmental concentrations of dissolved calcium and magnesium were analyzed by an EDTA (ethylenediaminetetraacetate) titration, and total hardness also determined chemically at the same time. Independently the average total hardness was determined from conductivity measurements of samples made on every visit throughout the year.

The aperture length of each limpet shell (AL) was measured by stage micrometer in 0.1 mm class intervals (Russell Hunter, 1961). Weights of shell calcium carbonate (and of "ash-free" tissue dry weights) were determined on whole limpets (starved for 48 hours). Analyses of shell organic carbon and nitrogen were run on limpet shells from which the tissues had been removed. For dry weights and shell weights, two procedures were followed. Selected individual limpets were oven-dried at 98°C to constant weight, then transferred to a muffle-furnace at 475°C for 105 min. This provided an ash weight (almost entirely shell  $\text{CaCO}_3$  in starved or laboratory-fed animals), a total dry weight, and by subtraction an ash-free dry weight (or tissue weight). Other individuals were oven dried at 98°C to constant weight and then treated with an ex-

cess of 12% nitric acid (8.5%  $\text{HNO}_3$ ) and then washed and redried, giving two dry weights (whole limpet and tissue) and by subtraction a value for dissolved calcium carbonate. Earlier studies on limpets (Russell Hunter, Apley, Burky & Meadows, 1967) had utilized 3% nitric acid (2.2%  $\text{HNO}_3$ ) which gives successful decalcification in other snails (Hunter & Lull, 1976, see also Richards & Richards, 1965). In *Ferrissia*, the results of muffle-furnace ashing could not be reconciled with those for decalcification with 3% nitric acid. A series of trials with limpets from BC and MHC (and with stocks of *Helisoma trivolvis*, see Russell-Hunter & Eversole, 1976) showed that significantly higher values for shell calcium resulted from decalcification with 8.5%  $\text{HNO}_3$ , and that these agreed with values obtained by ashing. [For Black Creek limpets, the following linear regressions of "total shell calcium carbonate" (S) in mg were computed: by 2.2%  $\text{HNO}_3$ ,  $S = -1.44 + 0.635 \text{ AL}$  ( $r$ -value of 0.95); by 8.5%  $\text{HNO}_3$ ,  $S = -1.95 + 0.927 \text{ AL}$  ( $r$ -value of 0.98); and by 475°C ashing,  $S = -1.92 + 0.933 \text{ AL}$  ( $r$ -value of 0.99).] Two sets of calcium analyses (each on ten limpets from BC) by the chloranilic acid method gave values closely corresponding to the 8.5%  $\text{HNO}_3$  regression (Dr. Christopher H. Price, unpublished). A series of additional tests revealed that a maximum of only 1.3% of the "total shell calcium carbonate" resulting from our standard 475°C ashing could not subsequently be dissolved by 8.5%  $\text{HNO}_3$  (Dr. Jay S. Tashiro, unpublished). There were no significant systematic differences between ashing whole animals, and ashing shells alone. With larger limpets (approximately 4.0 mm AL and larger), less than 3% of the "ash" weight was attributable to the limpet bodies when these were separated from the shells; and, with smaller sizes of limpets suitably starved, there was no detectable difference between "ash" values for whole limpets with shells and values for shells alone. Although we have data from ashing for three of the populations discussed here (BC, MHC, and CC), the results presented in detail below for the ten populations and used in subsequent computations are all derived from decalcification with 8.5%  $\text{HNO}_3$ .

Total organic carbon was determined on batches (selected by aperture length) of limpet shells using a wet oxidation colorimetric method (Russell-Hunter, Meadows, Apley & Burky, 1968). Values for smaller limpet shells (e.g., at AL = 2.2 mm) had to be determined

on batches of 24–27 individual shells of each cohort size. Analyses of total combined nitrogen on selected batches of shells were made on a Coleman model-29 semiautomatic nitrogen analyzer which employs a modified micro-Dumas method as described by Gustin (1960). Subsequent computational methods mostly utilized linear regressions. For some kinds of comparisons, shell  $\text{CaCO}_3$ , tissue dry weight, shell C, and shell N can be computed in terms of a "standard" limpet of modal size (3.5 mm AL), as read off from regressions for each of these components against shell size. Aperture length (AL) in limpets such as *Ferrissia rivularis* and *Laevapex fuscus* is a better measure of size (age) than similar shell measurements on other planorbid or turbinate snail species. Finally, all population samples used in the analyses were collected in early summer (thus avoiding any early spring complications from overwinter degrowth, see Russell-Hunter & Eversole, 1976) and, as already noted, all samples involving tissues had been starved for 48 hours (thus avoiding the complications of inorganic gut contents, see Hunter & Lull, 1976).

## RESULTS

In Tables 1–4 and in Fig. 1, data are arranged from left to right in order of increasing calcium concentration of the habitat waters (from MHC to LC). The conditions of the abiotic environment are set out in Table 1, including concentrations of dissolved calcium and magnesium, the average pH, and the altitude. In Table 1 are also set out assessments of the trophic state of the habitats, of the limpet densities, and of the pattern of life-cycle involved. As with other freshwater molluscs, there can be infraspecific variation in the number of generations per year in different populations of *Ferrissia rivularis* (Burky, 1971), and in similar pulmonates including ancyloid limpets (Russell-Hunter, 1964, 1978, and references therein). In the present set of ten populations, six have a simple annual life-cycle, two (CC and LC) have two generations with incomplete replacement (that is, representatives of both spring-born and late-summer born generations survive overwinter), and two (CR and CO) have two generations with complete replacement (that is, only the second or late-summer generation overwinters to breed in the next year).

The results of analyses of shell components

TABLE 1. Environmental conditions for ten localities in upstate New York where natural populations of *Ferrissia rivularis* were studied (the assessments of trophic productivity are: E = eutrophic, M = mesotrophic, O = oligotrophic; the limpet densities are H = high, M = medium, L = low and are given for two annual generations at CR and CC; and the limpet populations have either single annual generations, 1, or two generations per year with complete, 2C, or incomplete, 2I, replacement).

Population site	MHC	BC	SC	FC	BBC	CR	OL	CC	CO	LC
Dissolved calcium (mg/liter)	4.6	10.4	12.3	13.6	14.8	35.8	42.2	44.8	66.7	67.6
Dissolved magnesium (mg/liter)	0.9	3.2	2.9	4.9	4.5	5.4	7.2	11.0	18.7	14.6
Total hardness (mg CaCO <sub>3</sub> /liter)	25	39	48	54	59	133	145	156	243	199
Average pH	7.23	7.11	7.29	7.19	7.29	8.23	8.30	8.01	8.07	8.06
Altitude (ft. above sea level)	1,175	465	385	535	380	1,110	370	1,180	410	605
Trophic assessment (E, M, O)	O	O	M	O	M	E	E	M	E	M
Comparative limpet density (H, M, L)	H	H	H	M	M	L/M	L	L	L/H	M
Generations of limpets per year (1, 2I, 2C)	1	1	1	1	1	2C	1	2I	2C	2I

TABLE 2. Shell calcium carbonate content for ten natural populations of *Ferrissia rivularis* in upstate New York. For further explanation, see text.

Population site	MCH	BC	SC	FC	BBC	CR	OL	CC	CO	LC
Number of limpets	18	55	41	32	60	28	46	41	35	49
Number of batches	6	8	7	4	6	5	6	5	6	6
Limpet length range (mm)	3.1-4.9	2.0-4.6	2.0-5.9	1.9-4.7	1.9-4.2	2.4-4.3	2.3-4.8	2.1-4.6	1.8-4.8	2.3-4.2
Mean limpet length (mm)	3.68	3.17	3.01	2.92	2.86	3.13	3.18	2.86	3.20	3.02
Mean shell CaCO <sub>3</sub> (mg)	1.62	.993	.704	.547	.464	.656	.760	.578	1.30	.603
Shell CaCO <sub>3</sub> /limpet DW (mg/g)	670	649	698	621	636	696	699	721	749	674
Shell CaCO <sub>3</sub> /standard limpet (mg)	1.34	1.29	1.18	.800	.801	.938	.998	1.97	1.65	1.32

TABLE 3. Shell organic carbon content for ten natural populations of *Ferrissia rivularis* in upstate New York. For further explanation, see text.

Population site	MHC	BC	SC	FC	BBC	CR	OL	CC	CO	LC
Number of limpets	56	129	86	77	69	77	55	75	81	114
Number of batches	4	8	6	6	6	5	4	5	5	6
Limpet length range (mm)	2.5-4.6	2.1-5.1	1.6-5.6	1.4-4.9	1.7-4.9	2.1-4.9	2.4-4.8	2.0-5.5	1.5-4.9	1.6-5.4
Mean limpet length (mm)	3.29	3.46	3.21	3.07	2.98	3.42	3.46	3.68	3.11	3.64
Mean shell organic carbon ( $\mu\text{g}$ )	10.6	21.2	9.02	8.78	8.56	10.7	11.7	14.4	7.09	10.9
Shell C/Shell DW ( $\mu\text{g}/\text{mg}$ )	9.51	17.7	10.2	12.4	11.7	8.04	11.1	6.88	8.50	5.40
Shell C/standard limpet ( $\mu\text{g}$ )	12.6	21.0	10.9	11.7	12.3	11.3	12.1	12.3	9.13	10.1

TABLE 4. Shell nitrogen content and C:N ratio for ten natural populations of *Ferrissia rivularis* in upstate New York. For further explanation, see text.

Population site	MHC	BC	SC	FC	BBC	CR	OL	CC	CO	LC
Number of limpets	59	119	85	76	58	92	46	52	81	110
Number of batches	5	8	6	5	5	6	4	4	5	6
Limpet length range (mm)	2.3-4.6	2.0-4.8	1.4-5.3	1.3-4.6	1.9-5.1	1.7-5.0	2.3-5.0	1.6-5.0	1.7-5.0	2.5-5.4
Mean limpet length (mm)	3.45	3.47	3.16	2.96	3.08	3.39	3.52	2.77	3.11	3.99
Mean shell nitrogen ( $\mu\text{g}$ )	3.79	6.62	2.95	2.50	2.99	3.07	4.11	2.11	2.34	4.42
Shell N/Shell DW ( $\mu\text{g}/\text{mg}$ )	2.98	5.41	3.35	3.92	3.66	2.36	3.55	2.12	2.80	1.82
Shell C:N ratio	3.2	3.3	3.0	3.2	3.2	3.4	3.2	3.3	3.0	3.0
Shell N/standard limpet ( $\mu\text{g}$ )	4.02	6.69	3.64	3.47	4.18	3.28	3.96	4.72	2.89	2.70

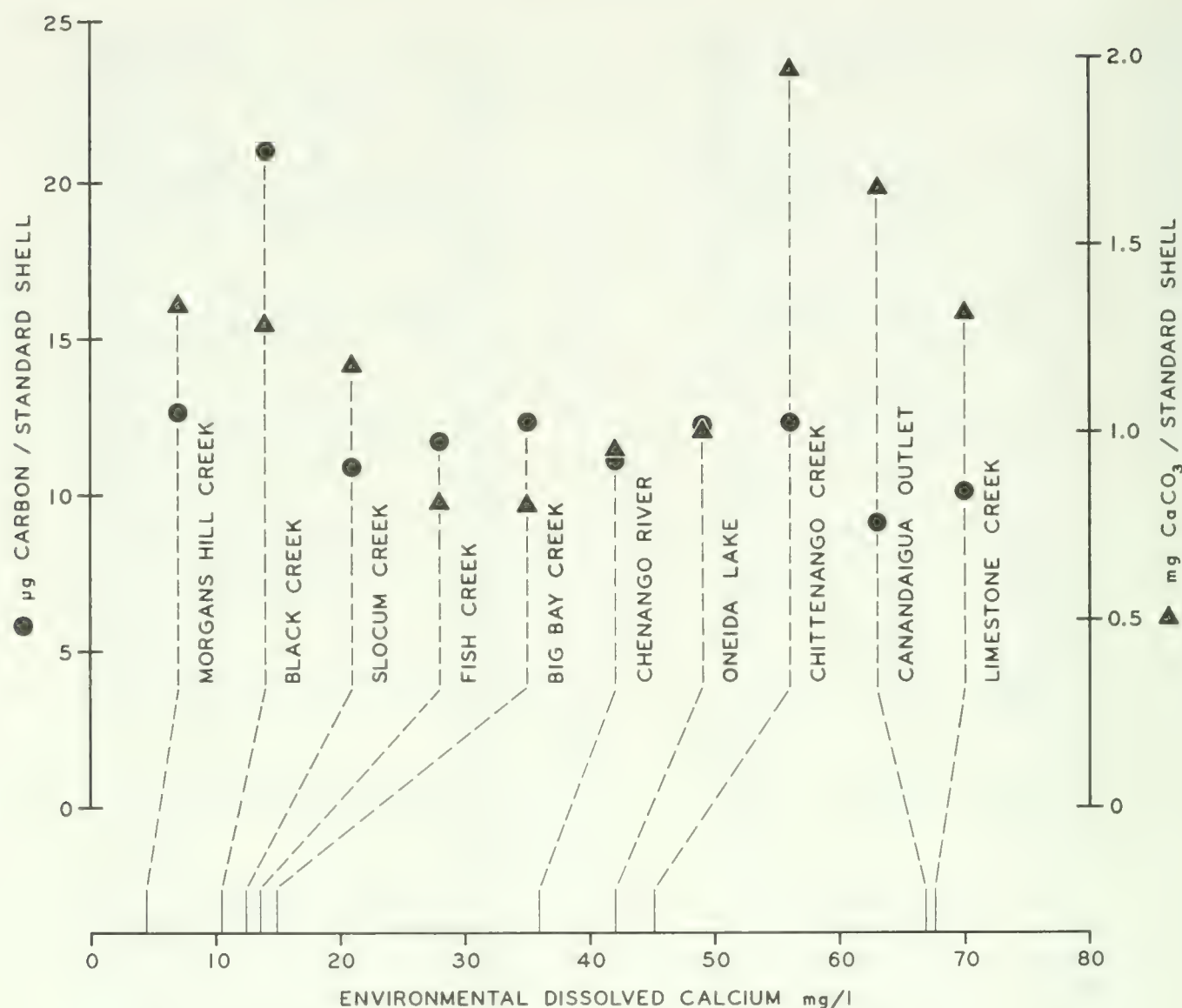

FIG. 1. Summary of shell component data for ten natural populations of *Ferrissia rivularis* in upstate New York. Shell carbon values (filled circles) are shown in  $\mu\text{g}$  organic carbon per standard shell (of 3.5 mm limpet derived from regression values). Shell nitrogen values closely parallel these (the noncalcareous component appears to be pure protein). Shell  $\text{CaCO}_3$  values (filled triangles) are shown in mg per standard shell. Note that the values are only ranked in order of increasing concentrations of environmental dissolved calcium; actual values for calcium content (mg/liter) being shown to scale only on the abscissa.

(shell calcium carbonate, total organic carbon, and total nitrogen) are set out in Tables 2–4. They are shown in the lower lines of the tables computed both as component fractions (mg/g) of dry weight (of limpets for  $\text{CaCO}_3$ , and of shell for organic C and for total N), and as values for the “standard limpet” of 3.5 mm AL. The 32 regression equations of components against shell size are not set out here, but can be made available to any interested investigator.

As shown in Table 2, there can be a twofold difference in mass of calcium carbonate (FC at 0.80 and CC at 1.97 mg) in the standard limpet. There is clearly no direct relationship to environmental dissolved calcium. Further,

computation of (somewhat arbitrary) “concentration ratios” between environmental calcium content and the calcium contents of whole limpet tissues (as wet weights—not shown in Table 2) show that these can range from 1,953 (LC) to 29,130 (MHC). This is clearly an interpopulation variable of considerable bioenergetic significance.

As shown in Table 3, the organic carbon content of *Ferrissia* shells also shows a more than twofold range, whether expressed as dry weight component fractions (mg/g) or as values for the “standard” limpet. The highest carbon content is found in the shells of the BC population, the lowest in CO (or LC depending on method of computation). Carbon val-



ues show no direct relationship with environmental dissolved calcium, and neither a direct nor an inverse relationship to shell calcium. Further, there is no obvious relationship of shell organic carbon content with the assessed productivity of the environment, or even with the productivity of the limpets themselves (which can be crudely assessed in terms of generations times densities, rather than simple densities). However, organic carbon content does correlate rather closely with total shell nitrogen.

As shown in Table 4, the total shell nitrogen content can vary over nearly a threefold range. The highest nitrogen content is again at BC while the lowest (by both computations) is at LC. The dry weight component values for nitrogen (line 7, Table 4) can be used with those for organic carbon (line 7, Table 3) to produce carbon:nitrogen (C:N) ratios for the limpet shells. These are all relatively uniform in the range 3.0:1 to 3.4:1 (an average value for pure animal protein would be C:N = 3.25:1, Brody, 1945; Russell-Hunter, 1970), and we can conclude that the noncalcareous component of these limpet shells is largely proteinaceous. In fact, the individual shell nitrogen values are closely parallel to those for shell organic carbon, and require no further separate discussion. Accordingly, Fig. 1 presents the relationship between only three variables for the ten population-sites: the mean values for dissolved calcium in the environmental waters, the noncalcareous components of the limpet shells as micrograms organic carbon per standard shell, and the calcareous component as milligrams  $\text{CaCO}_3$  per standard shell.

## DISCUSSION

Intraspecific (interpopulation) physiological variation in growth, fecundity, life-cycle pattern and respiration, as reported for many freshwater molluscs, appears in a number of cases to be based on distinct genotypes ("physiological races"). In such cases, transfer experiments between population-sites have shown that particular patterns of fecundity or ratios of shell dimensions are retained by "foreign" stocks introduced to other sites where the "native" snails have different characteristics. In other cases, notably of growth rates and size at maturity, stocks transferred to waters of markedly different hardness or trophic conditions take on similar external

characteristics to those shown by the natural population at the sites.

Apart from genetic controls of shell secretion, variation in the two principal components of the shells of freshwater snails—the crystalline calcium carbonate and the organic matrix—could be seen as depending upon available energy for shell-making (reflecting trophic conditions) and available precursors for components (reflecting on the one hand, available environmental calcium, and on the other hand, trophic conditions once again). A starving snail would not secrete much shell protein. Our present studies cannot discriminate among the noncalcareous components of the limpet shell, all shell protein (including both organic matrix fibers and periostracal sheets, and perhaps encompassing a polysaccharide fraction) being expressed as total organic carbon or as total combined nitrogens. Future work may allow both finer biochemical discrimination and more specific structural allocation. Recent X-ray diffraction studies (Weiner & Traub, 1980) have confirmed that the fibers of the organic matrix are a silk-like  $\beta$ -fibroin protein, as earlier suggested by studies on amino acid residues by Degens and his associates (Degens, Spencer & Parker, 1967; Ghiselin, Degens, Spencer & Parker, 1967; Degens, 1976), and by ultrastructural studies (Jones, 1969). Similarly, it is almost certain that the polysaccharide fraction found in certain mollusc shells is chitin. For the limited purposes of this discussion, secretion of *all* components of the organic fraction of the shell can be regarded as energy-consuming and dependent on trophic input.

Populations of molluscs with calcareous shells are found in fresh waters with more than 100-fold range in concentrations of dissolved calcium (Boycott, 1936; Russell-Hunter, 1964, 1978). Several workers have presented clear experimental evidence from laboratory cultures of direct effects of calcium concentration on the growth and fecundity of snails (Williams, 1970b; Harrison, Williams & Greig, 1970; Thomas, Benjamin, Lough & Aram, 1974). Correlations of environmental calcium with field distribution patterns and abundance have been demonstrated for several snail species (Williams, 1970a; McKillop & Harrison, 1972; Dussart, 1976, 1979). In temperate regions of the world, extremely soft waters (calcium concentrations  $< 3$  mg/liter) can support only about 5% of the molluscan species of the region, moderately soft waters ( $\text{Ca} < 10$  mg/liter) can support about 40%,

intermediate waters (10 to 25 mg/liter) can support up to 55%, with hard waters (Ca >25 mg/liter) being required for the rest (Boycott, 1936; Macan, 1950; Russell-Hunter, 1957, 1964, 1978). However, it is noteworthy that most of those species tolerant of low calcium could survive in, and are sometimes found in, harder waters (Russell-Hunter, 1964). Although Dussart (1976) had claimed that environmental calcium level was a major determinant of field abundance for several molluscan species, his more recent multiple regression analyses (Dussart, 1979) suggest that in some species, correlation is with other cations associated with water hardness rather than with calcium itself. Future experimental work may show that exclusion of "soft-water species" of molluscs from certain waters of high mineral content does not result from high calcium content as such.

The present paper reports populations of the freshwater limpet *Ferrissia rivularis* in waters with a nearly fifteen-fold range (4.6 to 67.6 mg/liter) of calcium content. The extremely euryoecic freshwater snail *Lymnaea peregra* can undoubtedly colonize an even wider range. In terms of organic productivity, waters supporting freshwater snails can again vary widely. *Lymnaea peregra* is found in the most oligotrophic mountain lakes, but also can occur in eutrophic (even hypertrophic, or mildly polluted) waters. Again the range of *Ferrissia rivularis* (Table 1) is somewhat less but still extensive. Direct environmental effects on variation in shell components in *F. rivularis* are not apparent (Fig. 1). The lightest shells in terms of calcium occur not in the three populations from the softest waters but at the two somewhat harder sites, the heaviest shells in waters of intermediate hardness (CC), and the overall range of apparent concentration ratios runs from 1,953:1 to 29,130:1.

If ratios of secretion of shell calcium and shell protein both depend upon levels of energy turnover, one might have expected a *direct* relationship between the two components (and possibly some relationship to the general trophic state of each habitat). Our ten limpet populations do not show this (Fig. 1). On the other hand, one could hypothesize that the adaptive need for a certain level of mechanical protection by the shell could result in an *inverse* relationship between shell calcium and shell protein. [In certain land snails of the tropical rain forest, relatively uncalcified shells have unusually massive pro-

teinaceous layers, and in certain freshwater sphaeriid clams there are supportive data for a similar inverse relationship (Burky, Benjamin, Catalano & Hornbach, 1979)]. Again, our ten natural populations of *F. rivularis* show no evidence of such an inverse relationship (Fig. 1). It should be noted that in content of shell protein and of shell calcium (as even more clearly in other measurable characters), the variation *within* the majority of single populations is very much *less* than the range of variation for the species as a whole.

It seems that genetic controls of shell secretion for the two major components are independent, and that the chances of genetic dispersal among the isolated creek populations of this limpet have resulted in an irregular distribution of shell forms. Obviously this anomalous variation in components found in *Ferrissia rivularis* differs from the patterns found in other freshwater snails.

In *Lymnaea peregra*, the mass of calcium carbonate in the shell varies directly with calcium available. The shell component differences in another North American freshwater limpet, *Laevapex fuscus*, are markedly less than those discussed for *Ferrissia*, but shell calcium content increases with calcium concentration (McMahon, 1973, 1975a). As regards the calcareous component then, in *Laevapex* and *Lymnaea peregra*, the shells of variable mass in different populations could result from similar energy expenditures in shell-making. A third pattern of relationship between shell calcium and the environment has been demonstrated for *Lymnaea palustris* (Hunter, 1972, 1975b), where a survey of fourteen population-sites showed that the ratio of shell calcium to whole animal dry weight changes little throughout growth, and does not vary greatly between populations. This proved true over a wide range of calcium concentrations of environmental water, and represents a "regulation" unusual in a species which shows great interpopulation variation in other respects. *Physa gyrina* (Hunter & Lull, 1977) appears to show similar "regulation." Hunter & Lull (1976, 1977) also studied natural populations of *Physa integra* and *Helisoma anceps*, and for these two species, there was no relationship between shell calcium to tissue ratios (which varied greatly from population to population) and the calcium concentrations of their environmental waters. In this "irregular" variation these species resembled the populations of *Ferrissia rivularis* described above. However, Hunter &

Lull (1977) claim that a similar ranking between these two species in seven population-sites where they co-exist is evidence for a possible relationship to trophic conditions. Unfortunately, there are no data on shell protein from these species-populations of the sort we have presented for *Ferrissia*.

Thus, at least four "patterns" of shell calcium relationship can be discerned in the data already available on freshwater pulmonates. These are: first, a direct relationship as in *Lymnaea peregra* and *Laevapex fuscus* between shell calcium and environmental hardness; secondly, a seeming "regulation" of calcareous shell secretion, as in *Lymnaea palustris* and *Physa gyrina*, resulting in shells of standard weight for size categories with each species; thirdly, a relationship between shell calcium secretion and general bioenergetic turnover (or trophic) rates, as was claimed for *Physa integra* and *Helisoma anceps*; and fourthly, great variation between (but not within) populations, as in *Ferrissia rivularis*, reflecting an irregular distribution of genetic "forms" neither obviously clinal nor adaptive (as claimed here). The fifth possible relationship—an inverse relationship between shell calcium and environmental calcium—has never been found in a pulmonate nor in other freshwater gastropods. However, Agrell (1949) found, in populations of the freshwater bivalve *Unio tumidus* in Sweden, that shell weights decreased from oligotrophic to eutrophic waters. For two other species of *Unio* and one of *Anodonta*, he found increasing shell weights with "rising trophic degree," essentially as claimed for *Physa integra* and *Helisoma anceps*.

"Over-compensation" in the form of increased calcium storage in populations in low calcium environments is better documented in plants, where pairs of closely-related species and subspecies have long been known to occur (Tansley, 1917; Salisbury, 1920; De Silva, 1934). Closer parallels to our possible physiological races in the limpet *Ferrissia*, irregularly distributed with no obvious geographic clines, are provided by the economically important grass, *Festuca ovina* (Bradshaw and Snaydon, 1959), and the ecologically important microorganism, *Azotobacter* (Bullock, Bush & Wilson, 1960). In the case of *Festuca*, population differentiation has resulted in "races," termed edaphic ecotypes, which when cultivated in a range of calcium levels show significantly different responses in growth rates and patterns.

In many pulmonates, shell shape is another infraspecific variable. Extensive data have been collected on shell biometrics in *Ferrissia rivularis* from a set of 53 populations in a variety of localities in upstate New York of varying trophic conditions and water hardness, and with different degrees of isolation from each other (Russell-Hunter and Nickerson, unpublished; Russell-Hunter, 1978). Certain shell-ratios (including isometric "roundness" in marginal growth) seem to be rather rigidly genetically determined, while others (allometric "steepness" of the cone) reflect local growth patterns as modified by trophic conditions. None of the present data on interpopulation variation in shell components can be directly related to either kind of shell-ratios as determined for this set of populations.

Despite all this, it seems reasonable to hypothesize that, in *Ferrissia*, differences between populations in both shell-calcium secretion and shell-protein synthesis and secretion are under independent genetic control, and that the different genomes are "irregularly" (not necessarily adaptively, nor in geographic clines) distributed among the isolated creek populations as a result of the stochastic element introduced by passive dispersal of single propagule individuals. Short reviews of evidence on passive dispersal of freshwater molluscs are provided by Rees (1965) and Russell-Hunter (1978). Two consequences of this kind of infraspecific variation remain to be discussed: one related to assessments of radionuclide pollution in fresh waters, and the other to broader aspects of evolutionary processes in freshwater animals.

Molluscs of various sorts have been proposed as indicators of environmental radiocontamination with strontium-90 (Nelson, 1964; Rosenthal, Nelson & Gardiner, 1965) which they found to be accumulated indiscriminately with calcium. Likins, Berry & Posner (1963) claimed relative discrimination against strontium in *Australorbis glabratus*, but Van Der Borght and Van Puymbroeck (1964, 1966) demonstrated active uptake direct from environmental water of both calcium and strontium in pulmonates such as *Lymnaea stagnalis*, *L. auricularia* and *Planorbis corneus*. Further, their work showed that 80% of shell calcium gained by growing snails comes directly from the water, and only 20% indirectly through their food. Thus, it becomes important that some freshwater mollusc species have populations which differ significantly from each other in

the extent to which they *do* concentrate calcium from the environment. It is worth noting that the range of apparent concentration ratios (1,953:1 to 29,130:1) for *Ferrissia* populations noted above do not necessarily measure calcium transport costs through successive physiological "compartments" on the way to the shell, nor do they assess relative bioenergetic expenditures by the stocks in any actuarial framework of assimilation and growth. They are sufficiently different, however, to suggest that any proposed use of a freshwater mollusc species in a biological assay of strontium-90 pollution would have to be based upon a set of stocks known to be genetically uniform in such aspects of calcium metabolism.

Finally, these data on interpopulation variation in the calcareous and proteinaceous shell components in *Ferrissia*, and the subsequent deductions regarding their bases in an "irregular" distribution of genetic units by the chances of passive dispersal in the establishment of isolated creek populations can be added to lists of other types of physiological variation already documented for freshwater molluscs. All provide evidence that the rates and modes of evolutionary change which have worked to produce present (and past) freshwater molluscan faunas, differ markedly from those which have operated for similar animals living in the sea or on land. As more fully discussed elsewhere (see, for example, Russell-Hunter, 1961, 1964, 1978), a dominant characteristic of the freshwater environment is that the transience of most freshwater habitats in time, along with their spatial limitations and discontinuity, results in animal species distributed with much small-scale and short-term isolation of populations. Comparatively little full speciation occurs in freshwater animals like gastropod molluscs, since this is prevented by sufficient gene exchange resulting from limited and rare transfers of individuals between populations by passive dispersal. In contrast, much infraspecific interpopulation variation can and does occur because of the short-term, smaller scale isolation of discretely panmictic population-units. Where the high levels of interpopulation variation in some physiological or morphological characteristic have been investigated in detail there is always one consistent feature. The amount of variation found within any single population is always much less than the range of that character's variation for the species as a whole. Considering certain other features of

the physiology of freshwater molluscs (particularly respiration), one also encounters stocks with exceptionally high levels of adaptive plasticity. All of these features of freshwater molluscs reflect the environmental discontinuities of time and space during their evolution. The irregular distribution of shell components found in these creek populations of *Ferrissia* again reflects the peculiarities of dispersal, gene-flow, and evolutionary rates in such freshwater habitats.

#### ACKNOWLEDGMENTS

The senior author is particularly indebted to Dr. Jay Shiro Tashiro for much help with the necessary redeterminations of the calcareous component in limpet samples. We are most grateful to Dr. Richard P. Nickerson for some additional organic determinations, and we must also thank Drs. Christopher H. Price and Arnold G. Eversole, for help with the field work and in the laboratory. The senior author is also grateful to Drs. Robert A. Browne, Jay Shiro Tashiro, and David W. Aldridge, and to Wendy W. Lull and Perry Russell-Hunter, for help checking data transcriptions and computations; and to T. Braun, Catherine M. Herrity, Ann Evans, and Colette O'B. McMahon for help in manuscript preparation.

#### REFERENCES CITED

- AGRELL, I., 1949, The shell morphology of some Swedish unionides as affected by ecological conditions. *Arkiv för Zoologi*, 41A(15): 1-30.
- BOYCOTT, A. E., 1936, The habitats of fresh-water Mollusca in Britain. *Journal of Animal Ecology*, 5: 116-186.
- BRADSHAW, A. D. & SNAYDON, R. W., 1959, Population differentiation within plant species in response to soil factors. *Nature*, 183: 129-130.
- BRODY, S., 1945, *Bioenergetics and Growth*. Reinhold, New York, 1023 p.
- BULLOCK, G. L., BUSH, J. A. & WILSON, P. W., 1960, Calcium requirements of various species of *Azotobacter*. *Proceedings of the Society for Experimental Biology and Medicine*, 105: 26-30.
- BURKY, A. J., 1970, Reverse acclimation at low temperature in the stream limpet, *Ferrissia rivularis* (Say). *Acta Cientifica Venezolana*, 21: 28.
- BURKY, A. J., 1971, Biomass turnover, respiration and interpopulation variation in the stream limpet, *Ferrissia rivularis* (Say). *Ecological Monographs*, 41: 235-251.

- BURKY, A. J., BENJAMIN, M. A., CATALANO, D. M. & HORNBAACH, D. J., 1979, The ratio of calcareous and organic shell components of freshwater sphaeriid clams in relation to water hardness and trophic conditions. *Journal of Molluscan Studies*, 45: 312–321.
- DEGENS, E. T., 1976, Molecular mechanisms on carbonate, phosphate and silica deposition in the living cell. *Topics in Current Chemistry*, 64: 1–112.
- DEGENS, E. T., SPENCER, D. W. & PARKER, R. H., 1967, Paleobiochemistry of molluscan shell proteins. *Comparative Biochemistry and Physiology*, 20: 553–579.
- DE SILVA, B. L. T., 1934, The distribution of "Calcicole" and "Calcifuge" species in relation to the content of the soil in calcium carbonate and exchangeable calcium, and to soil reaction. *Journal of Ecology*, 22: 532–553.
- DUSSART, G. B. J., 1976, The ecology of freshwater molluscs in North West England in relation to water chemistry. *Journal of Molluscan Studies*, 42: 181–198.
- DUSSART, G. B. J., 1979, Life cycles and distribution of the aquatic gastropod molluscs *Bithynia tentaculata* (L.), *Gyraulus albus* (Müller), *Planorbis planorbis* (L.) and *Lymnaea peregra* (Müller) in relation to water chemistry. *Hydrobiologia*, 67: 223–239.
- GHISELIN, M. T., DEGENS, E. T., SPENCER, D. W. & PARKER, R. H., 1967, A phylogenetic survey of molluscan shell matrix proteins. *Breviora of the Museum of Comparative Zoology*, 262: 1–23.
- GUSTIN, G. M., 1960, A simple rapid automatic micro-Dumas apparatus for nitrogen determination. *Microchemical Journal*, 4: 43–54.
- HARRISON, A. D., WILLIAMS, N. V. & GREIG, G., 1970, Studies on the effects of calcium bicarbonate concentrations on the biology of *Biomphalaria pfeifferi* (Krauss) (Gastropoda: Pulmonata). *Hydrobiologia*, 36: 317–327.
- HUBENDICK, B., 1947, Die Verbreitungsverhältnisse der limnischen Gastropoden in Südschweden. *Zoologiska Bidrag från Uppsala*, 24: 419–559.
- HUNTER, R. D., 1972, *Energy budgets and physiological variation in natural populations of the freshwater pulmonate Lymnaea palustris*. Ph.D. thesis, Syracuse University, 115 p. (Dissertation Abstracts, 33, 5066-B, order no. 73-9534).
- HUNTER, R. D., 1975a, Growth, fecundity, and bioenergetics in three populations of *Lymnaea palustris* in upstate New York. *Ecology*, 56: 50–63.
- HUNTER, R. D., 1975b, Variation in populations of *Lymnaea palustris* in upstate New York. *American Midland Naturalist*, 94: 401–420.
- HUNTER, R. D. & LULL, W. W., 1976, A comparison of two methods for estimating the weight of inorganic materials in molluscs. *Malacological Review*, 9: 118–120.
- HUNTER, R. D. & LULL, W. W., 1977, Physiologic and environmental factors influencing the calcium-to-tissue ratio in populations of three species of freshwater pulmonate snails. *Oecologia*, 29: 205–218.
- JONES, T., 1969, Aspects of calcification in gastropods. *Proceedings of the Malacological Society of London*, 38: 549–550.
- LIKINS, R. C., BERRY, E. G. & POSNER, A. S., 1963, Comparative fixation of calcium and strontium by snail shell. *Annals of the New York Academy of Science*, 109: 269–277.
- MACAN, T. T., 1950, Ecology of fresh-water Mollusca in the English Lake District. *Journal of Animal Ecology*, 19: 124–146.
- MCKILLOP, W. B. & HARRISON, A. D., 1972, Distribution of aquatic gastropods across an interface between the Canadian Shield and limestone formations. *Canadian Journal of Zoology*, 50: 1433–1445.
- MCMAHON, R. F., 1973, Respiratory variation and acclimation in the freshwater limpet, *Laevapex fuscus*. *Biological Bulletin*, 145: 492–508.
- MCMAHON, R. F., 1975a, Growth, reproduction and bioenergetic variation in three natural populations of the freshwater limpet *Laevapex fuscus* (C. B. Adams). *Proceedings of the Malacological Society of London*, 41: 331–351.
- MCMAHON, R. F., 1975b, Growth, reproduction and life-cycle in six Texas populations of two species of freshwater limpets. *American Midland Naturalist*, 94: 174–185.
- NELSON, D. J., 1964, Biological vectors and reservoirs of strontium-90. *Nature*, 203: 420.
- REES, W. J., 1965, The aerial dispersal of molluscs. *Proceedings of the Malacological Society of London*, 36: 269–282.
- RICHARDS, N. J. & RICHARDS, S. W., 1965, Effect of decalcification procedures on the dry weights of benthic invertebrates. *Limnology and Oceanography*, 10: 469–471.
- ROSENTHAL, G. M., JR., NELSON, D. J. & GARDINER, D. A., 1965, Deposition of strontium and calcium in snail shell. *Nature*, 207: 51–54.
- RUSSELL HUNTER, W., 1953, On the growth of the fresh-water limpet, *Ancylus fluviatilis* Müller. *Proceedings of the Zoological Society of London*, 123: 623–636.
- RUSSELL HUNTER, W., 1957, Studies on freshwater snails at Loch Lomond. *Glasgow University Publications, Studies on Loch Lomond*, 1: 56–95.
- RUSSELL HUNTER, W., 1961, Life cycles of four freshwater snails in limited populations in Loch Lomond, with a discussion of infraspecific variation. *Proceedings of the Zoological Society of London*, 137: 135–171.
- RUSSELL HUNTER, W., 1964, Physiological aspects of ecology in non-marine molluscs, p. 83–126 in WILBUR, K. M. & YONGE, C. M., eds., *Physiology of Mollusca*, Vol. 1. Academic Press, New York and London.
- RUSSELL-HUNTER, W. D., 1970, *Aquatic productivity*. Macmillan, New York, 306 p.

- RUSSELL-HUNTER, W. D., 1978, Ecology of freshwater pulmonates, p. 335–383 in FRETTER, V. & PEAKE, J. F., eds., *Pulmonates*, Vol. 2A: *Systematics, Evolution and Ecology*. Academic Press, New York and London.
- RUSSELL-HUNTER, W. D. & EVERSOLE, A. G., 1976, Evidence for tissue degrowth in starved freshwater pulmonate snails (*Helisoma trivolvis*) from tissue, carbon, and nitrogen analyses. *Comparative Biochemistry and Physiology*, 54A: 447–453.
- RUSSELL-HUNTER, W. D., BURKY, A. J. & HUNTER, R. D., 1970, Interpopulation variation in shell components in the stream limpet, *Ferrissia rivularis*. *Biological Bulletin*, 139: 402.
- RUSSELL HUNTER, W., APLEY, M. L., BURKY, A. J. & MEADOWS, R. T., 1967, Interpopulation variations in calcium metabolism in the stream limpet, *Ferrissia rivularis* (Say). *Science*, 155: 338–340.
- RUSSELL-HUNTER, W. D., MEADOWS, R. T., APLEY, M. L. & BURKY, A. J., 1968, On the use of a "wet-oxidation" method for estimates of total organic carbon in mollusc growth studies. *Proceedings of the Malacological Society of London*, 38: 1–11.
- SALISBURY, E. J., 1920, The significance of the calcicolous habit. *Journal of Ecology*, 8: 202–215.
- TANSLEY, A. G., 1917, On competition between *Galium saxatile* (*G. hercynicum* Weig.) and *Galium sylvestre* Poll. (*G. asperum* Schreb.) on different types of soil. *Journal of Ecology*, 5: 173–179.
- THOMAS, J. D., BENJAMIN, M., LOUGH, A. & ARAM, R. H., 1974, The effects of calcium in the external environment on the growth and natality rates of *Biomphalaria glabrata* (Say). *Journal of Animal Ecology*, 43: 839–860.
- VAN DER BORGHT, O. & VAN PUYMBROECK, S., 1964, Active transport of alkaline earth ions as physiological base of the accumulation of some radionuclides in freshwater molluscs. *Nature*, 204: 533–534.
- VAN DER BORGHT, O. & VAN PUYMBROECK, S., 1966, Calcium metabolism in a freshwater mollusc: quantitative importance of water and food as supply for calcium during growth. *Nature*, 210: 791–793.
- WEINER, S. & TRAUB, W., 1980, X-ray diffraction study of the insoluble organic matrix of mollusk shells. *F.E.B.S. Letters*, 111: 311–316.
- WILLIAMS, N. V., 1970a, Studies on aquatic pulmonate snails in Central Africa. 1. Field distribution in relation to water chemistry. *Malacologia*, 10: 153–164.
- WILLIAMS, N. V., 1970b, Studies on aquatic pulmonate snails in Central Africa. 2. Experimental investigation of field distribution patterns. *Malacologia*, 10: 165–180.

THE ARENOPHILIC RADIAL MANTLE GLANDS OF THE  
LYONSIIDAE (BIVALVIA: ANOMALODESMATA) WITH  
NOTES ON LYONSIID EVOLUTION<sup>1</sup>

Robert S. Prezant

*College of Marine Studies, University of Delaware, Lewes, Delaware 19958, U.S.A.*

ABSTRACT

Two of the three marine genera of Lyonsiidae (*Lyonsia* and *Entodesma*) possess small, multicellular glands that line at least a portion of their mantle edge. The glands, which are evenly dispersed along the entire mantle edge of *Lyonsia* but may regress quantitatively with overall growth in some *Entodesma*, are modifications of the inner epithelium of the outer mantle fold. The gland system in both genera is composed of a central, club-shaped gland of two basic cell types and a surrounding secretory sheath. The latter is derived from the outer fold epithelium in *Entodesma* and the middle fold epithelium in *Lyonsia*. Central gland cells and surrounding sheath cells show a complex ultrastructure typical of secretory cells. Roughly triangular or ovoid medial cells of the central gland and flat surrounding sheath cells secrete a weakly acidic mucopolysaccharide over a thick glycoprotein layer produced by tall flask-shaped cells of the central gland. In *Lyonsia*, glands open into the periostracal groove and secrete above the periostracum. In *Entodesma* they open distal to the groove and the secretion periodically penetrates and emerges above the periostracum. The secretion from *Entodesma* may possess a protease that allows the localized dissolution of periostracum. The mucoid secretion is active in adhesion of foreign particles to the exterior surface of the shell, and may play a role in stabilizing or protecting the thin-shelled *Lyonsia* or juvenile or smaller sized species of *Entodesma*. The mucopolysaccharide component of the bilayered secretion may act as a lubricant during release of the more viscous glycoprotein, or as an initial adhesive following release. In *Entodesma* this polysaccharide layer may also form a protective shield buffering other tissues from potential enzymatic activity. Based upon structure and location of arenophilic glands, as well as shell ultrastructure, general anatomy and specific habits, an early split in lyonsiid phylogeny is hypothesized. From an ancestral, free-living *Lyonsia*-like bivalve, two branches diverged; one branch produced *Lyonsia*, and the second the *Entodesma* lineage. *Mytilimeria*, the third marine lyonsiid genus, lost the arenophilic glands, and is an offshoot of the *Entodesma* stock.

INTRODUCTION

The molluscan mantle edge has provided an important vehicle for divergent evolution and resulting diversity within the phylum. The wide variety of functions that this organ has developed (Dakin, 1928; Fretter & Graham, 1954; Thompson, 1960; Hillman & Shuster, 1960, 1966; Hodgkin, 1962; Hillman, 1964, 1968, 1969; Gilmour, 1967; Muscatine, 1967; Carriker, 1972; Prezant, 1979a) is a representation of its phylogenetic significance. The role of the mantle in molluscan evolution has been discussed by Stasek & McWilliams (1973).

Part of this phylogenetic progression has included the development of clusters of mucocytes along specific regions of the

mantle. Hillman & Shuster (1960, 1966) and Hillman (1964, 1969) found two different areas of the mantle edge of *Mercenaria mercenaria* specialized for the secretion of mucoid products and suggested that they function in cleansing the mantle cavity, and in the production and elaboration of shell material, respectively. Hypobranchial glands of numerous prosobranchs secrete copious amounts of mucus (Ronkin & Ronkin, 1951; Ronkin, 1952), as do accessory mantle folds of many chitons (Stasek & McWilliams, 1973). In some scaphopods, such as *Dentalium*, the anterior mantle rim is swollen with subepithelial mucocytes that actively aid in binding extraneous materials and debris for expulsion (Stasek & McWilliams, 1973). Mucoid secretions play other roles in molluscs ranging

<sup>1</sup>University of Delaware, College of Marine Studies, Contribution No. 153.

from pedal lubricants in gastropods to food carriers and condensers in bivalves, to courtship in many terrestrial slugs (Hyman, 1967).

Mucoid secretions seem particularly important among many bivalves of the subclass Anomalodesmata. *Thracia phaseolina*, a burrower in shelly gravels, produces mucus-lined inhalant and exhalant tubes that penetrate the surface and allow access of functional feeding and respiratory currents from its burrow (Yonge & Thompson, 1976). Similar mucus-lined tubes are formed by *Cochloidesma praetenuae*, but the exhalant siphon does not penetrate the substratum surface and instead lies in a horizontal plane as does the animal (Allen, 1958). *Lyonsia hyalina* has a series of small, multicellular glands lining the mantle edge that secrete a mucoid substance over the periostracum (Prezant, 1979a). This secretion, in conjunction with numerous shell spinules that cover the shell exterior (Prezant, 1979b), function in adhesion of foreign material to the shell. Similar glands, almost certainly of similar adhesive function and termed "radial mantle glands" (Allen & Turner, 1974), were previously found in some deep-sea Verticordiidae by Allen & Turner (1974). For the purposes of this paper, these organs are termed arenophilic radial mantle glands based upon their role in sand or foreign particle adhesion.

Many other species of *Lyonsia* as well as *Entodesma*, among the Lyonsiidae, have sediment adhering to their periostracum; it has been hypothesized that they, too, possess arenophilic mantle glands (Prezant, 1979a). The third genus of marine Lyonsiidae, *Mytilimeria*, may also possess some modification of the mantle and periostracum that allows a tight adhesion within its tunicate host. Yonge (1952) suspected that this adhesion might be a reflection of attachment to a still fluid or "sticky" periostracum. Prezant (1980a) found the periostracum of *M. nuttalli* to be covered with small crater-like pores that may play a role in this adhesion.

Contrary to the sessile habits of *Mytilimeria*, *Lyonsia* is a mobile bivalve found partially buried in fine sediments where it is loosely secured by a few, thin byssal threads. *Entodesma*, containing the largest and thickest shelled members of the Lyonsiidae, occurs nestled within crevices along rocky shorelines, or among tunicates, sponges or algal holdfasts. Members of each genus show some indication of an adhesive periostracum although it is most evident in the sand-

covered *Lyonsia*. Prezant (1979a) noted that the sand cover of *L. hyalina* serves three purposes: protection of the thin shell, camouflage, and increased stabilization in the substratum due to increased external surface area and added weight. The ecologic divergence of the Lyonsiidae may parallel the development of arenophilic mantle glands. Yonge (1952) envisaged an orthogenetic lineage within the Lyonsiidae, originating in the Eocene (Yonge & Morton, 1979), based upon intrafamilial morphology and life styles, from a free-living *Lyonsia* to a more sedentary *Entodesma* to a sessile *Mytilimeria*. The present study has two main goals: first to explore the distribution, structure, and function of arenophilic radial mantle glands among the Lyonsiidae; and second, to examine the question of lyonsiid evolution with respect to functional morphology and arenophilic mantle glands.

#### MATERIALS AND METHODS

The following live specimens of lyonsiids were used in this research: *Lyonsia floridana* from fine to medium grained shelly-sand in shallow waters at Blind Pass, Sanibel, Florida; *L. californica* and *Mytilimeria nuttalli* from the Venice, California coast; *L. hyalina* from a muddy sand substratum at a depth of about 15 m in Delaware Bay, Delaware; and *Entodesma saxicola*, found nestled within rocky crevices just subtidally along Shaw Island, Washington. *M. nuttalli* was found embedded in compound tunicates, probably *Eudistoma psammion*. Previously preserved specimens (usually formalin fixed and ethanol preserved) which were examined included: *L. gouldii* from San Diego, California; *L. pugetensis* from Chignik Bay, Alaska; *Entodesma fretalis* from Corral Bay, Chile; *E. chilensis* from Corral Bay, Chile (Zenker's fluid fixed, ethanol preserved); *E. beana* from Vieques Island; *E. patagonica* from Argentina; and *E. saxicola* from British Columbia. *Entodesma fretalis* and *E. chilensis* were both found among the tunicate *Pyura chilensis*. Non-lyonsiid Anomalodesmata examined for comparative purposes included: *Pandora gouldiana* collected live from Delaware Bay; *Periploma fragile* collected live from Massachusetts Bay; and formalin fixed-ethanol preserved specimens of *Pandora inaequalis* and *Cochloidesma praetenuae* from Isle of Cumbrae, Scotland; and *Laternula truncata* from Loo Bay, Lubang Island, Philippines.



Live animals were maintained for short periods of time prior to fixation on running seawater tables with recirculating, sand filtered water at 12°C and 30 ppt salinity. Some were fed *Thalassiosira pseudonana* and *Isochrysis galbana*.

For histological purposes, live animals were relaxed in a 7% magnesium chloride solution, and fixed in either Zenker's or Hollande Bouin's fluid. Small specimens were fixed in toto while small parts of the mantle of larger specimens were fixed separately. Samples were fixed for 18–24 hr and then washed overnight in running tap water, dehydrated in a consecutive series of increasing concentrations of ethanol and embedded in polyester wax. Sections were cut at 5–10  $\mu\text{m}$ , mounted on albuminized slides and stained with either Heidenhain's iron or Groat's hematoxylin counterstained with eosin Y, Heidenhain's Azan or a modification of the Pantin trichrome (Prezant, 1979a). Specimens used for histochemical analysis of polysaccharides were

fixed in Rossman's fluid or a mixture of 9 parts absolute ethanol and 1 part formalin. For protein histochemistry, specimens were fixed in 10% formalin buffered to pH 7.2 with sodium phosphate. Specimens for histochemistry were embedded in paraffin or polyester wax and sectioned at 6–10  $\mu\text{m}$ . The histochemical tests, along with their specificity, are noted in Table 1.

Only living specimens were used for histochemistry or transmission electron microscopic observations. These included *Lyonsia californica*, *L. floridana*, and *Entodesma saxicola* although some polysaccharide histochemistry was performed on other alcohol fixed species. Small pieces of the mantle were fixed in cold Anderson's glutaraldehyde fixative in a sodium phosphate buffer at pH 7.2 for one hour for ultrastructural examination. Following primary fixation, specimens were washed in several changes of phosphate buffer solution, post-fixed in 2.0% osmium tetroxide in a phosphate buffer, also

TABLE 1. Histochemical tests used in analysis of arenophilic radial mantle glands and gland secretions of lyonsiid bivalves.

Test	Specificity	Reference
2% toluidine blue in 1% sodium borate	metachromatic substances mucopolysaccharides	Humason, 1972 Pearse, 1968
periodic acid Schiff (PAS), alcoholic	periodate reactive material potential mucins	Barka & Anderson, 1965
PAS/diastase	glycogen	Pearse, 1968
1% alcian blue, pH 1.0	sulfated mucosubstances	Pearse, 1968
1% alcian blue, pH 2.5	weakly acidic mucosubstances	Pearse, 1968
0.1% alcian blue, pH 5.7 at critical electrolyte levels:	below 0.3 M sulfated mucins and glucosaminoglucuronoglycans containing carboxyl groups, 0.2 M and above only sulfated mucosubstances (chondroitin sulfates up to 0.5 M, some sulfomucins and heparin up to 1.0 M)	Scott et al., 1964 Pearse, 1968
0.1 M $\text{MgCl}_2 \cdot 4\text{H}_2\text{O}$		
0.2 M $\text{MgCl}_2 \cdot 4\text{H}_2\text{O}$		
0.4 M $\text{MgCl}_2 \cdot 4\text{H}_2\text{O}$		
0.5 M $\text{MgCl}_2 \cdot 4\text{H}_2\text{O}$		
0.8 M $\text{MgCl}_2 \cdot 4\text{H}_2\text{O}$		
1.0 M $\text{MgCl}_2 \cdot 4\text{H}_2\text{O}$		
1% alcian blue/PAS, aqueous	periodate reactive material, alcinophilic mucosubstances (all but most strongly acidic)	Pearse, 1968 Thompson, 1966
ninhydrin Schiff	protein-bound amines	Barka & Anderson, 1965 Thompson, 1966
mercury-bromphenol blue	proteins	Barka & Anderson, 1965
mercury orange	sulfhydryl groups	Barka & Anderson, 1965
dihydroxy-dinaphthyl-disulfide	sulfhydryl groups	Barka & Anderson, 1965
mercury orange/thioglycerol	disulfide groups	Barka & Anderson, 1965
dihydroxy-dinaphthyl-disulfide/thioglycerol	disulfide groups	Barka & Anderson, 1965

at pH 7.2, for another hour, washed in buffer, dehydrated in an acetone or ethanol series and embedded in either Spurr's low viscosity embedding medium or Epon 812. Thin sections were cut on a Porter-Blum MT-1 ultramicrotome using glass or diamond knives and stained with Sato lead and uranyl acetate. Thin sections were examined on a Philips EM 201 transmission electron microscope at an accelerating voltage of 80 kV.

Lyonsiid valves were dehydrated in an ethanol series up through several changes of absolute and placed in a 60°C oven for 5–10 days for ultrastructural examination of the periostracum and any mantle secretions over the periostracum. They were then mounted with silver paint on aluminum stubs, coated with a thin layer of carbon and gold in a Denton Vacuum 515 Evaporator, and examined on a Philips PSEM 501 scanning electron microscope at accelerating voltages of 15–30 kV.

In order to examine potential replacement of sediments over the periostracum, live specimens of *Lyonsia californica*, *L. floridana*, *Entodesma saxicola* and *Mytilimeria nuttalli* (removed from its ascidian host), from various size classes, were cleaned of all adhering particles and placed in a clean, fine sand substratum on the seawater tables. These specimens were fed a mixture of *Thalassiosira pseudonana* and *Isochrysis galbana* every other day for a period of five weeks and showed slow, but evident growth. After this time, specimens were examined for newly adhering particles.

All figures are light micrographs taken on a Wild-M20 compound microscope unless otherwise noted.

## RESULTS

### *General anatomy of the arenophilic gland system*

Of the three genera of marine Lyonsiidae (Prezant, 1980b), only *Lyonsia* and *Entodesma* possess arenophilic radial mantle glands. The glands of these two genera are histologically and cytologically similar. They are readily distinguishable, however, based upon location with respect to the periostracal groove, and origin of a thin, at times almost membranous, surrounding epithelial sheath (Fig. 1).

The gross anatomy of arenophilic glands of

all species of *Lyonsia* that have been examined is similar to that of *L. hyalina* (Prezant, 1979a). The glands, which always occur jointly in the mantle of *Lyonsia* as one in the left outer fold lying opposite another in the right, are modifications of the inner epithelium of the outer fold. These regions consist of a central, club-shaped ridge of secretory cells in the longitudinal axis of the wall of a mantle in-pocketing, surrounded by a thin extension of the middle fold. The extension is confluent with the distal part of the central gland and merges with the central gland along its inner, longitudinal border (Figs. 1, 12, 13). This epithelial sheath of cells forms an effective coat around all but the apical, external end of the

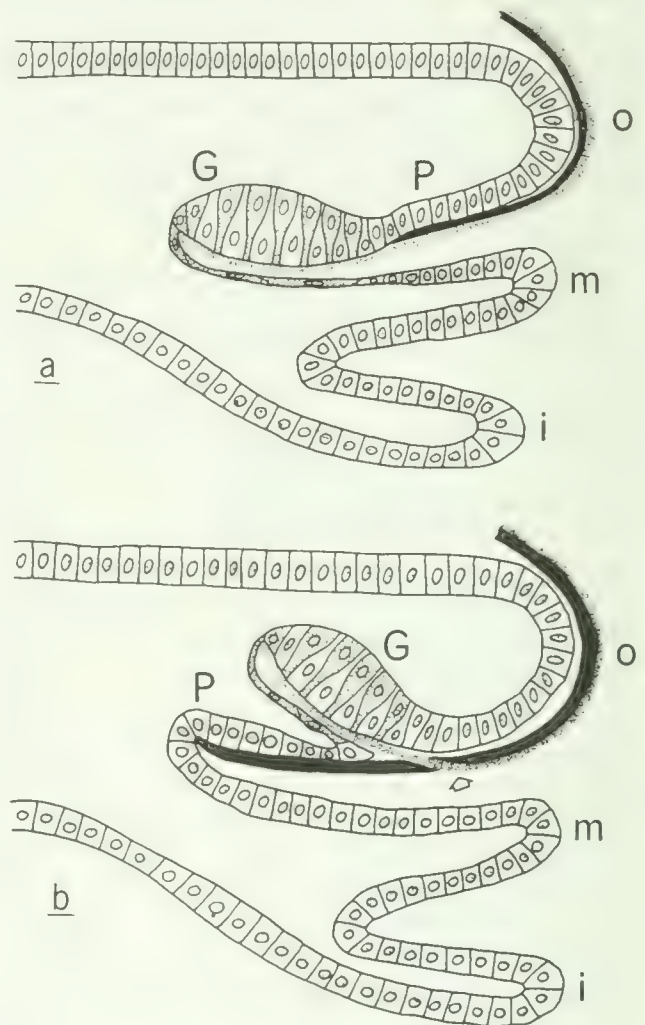

FIG. 1. Diagrammatic representation of the two types of arenophilic glands found in Lyonsiids. 1a represents the gland as found in *Lyonsia*, and 1b, that found in *Entodesma*. Open arrow in 1b points out the split in periostracum at the region of arenophilic gland secretion in *Entodesma*. Dark, solid layer represents the periostracum and the stippled layer the gland secretion. G, arenophilic gland; i, inner mantle fold; m, middle mantle fold; o, outer mantle fold; P, periostracum secreting cells. 1a is after Prezant 1979a, fig. 2.



FIG. 2. *Lyonsia floridana*. Scanning electron micrograph of single thread of mucoïd secretion from arenophilic gland overriding concentric periostracal ridge. Horizontal field width = 850  $\mu\text{m}$ .

central gland. Both the central gland cells and the surrounding sheath cells are secretory.

The apical end of the central gland in *Lyonsia* opens into the periostracal groove, behind the periostracum-secreting cells, via an invagination of the outer fold epithelium. The secretion from the glands is released as thin, sometimes ramifying, threads above the periostracum (Fig. 2). A full description of the mantle inpocketing and associated neck cells through which the gland secretes is given elsewhere (Prezant, 1979a). Briefly, the inner epithelium of the outer fold invaginates to form a pocket with recessed lateral borders (Fig. 3). Numerous, thin muscle fibers, originating from the inner pallial musculature, attach to the neck region of the individual glands and function in retracting these protrusible organs. The arenophilic glands of *Lyonsia* form small papillations along the

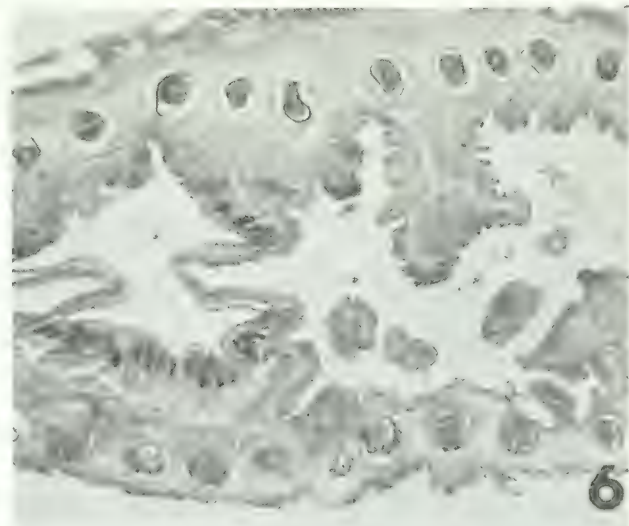

FIG. 3. *Lyonsia floridana*. External, recessed pocket of arenophilic gland, frontal section. Portion of central gland at arrow. Zenker's fluid, Pantin modification. Horizontal field width = 45  $\mu\text{m}$ . FIG. 4. *Lyonsia californica*. Protruding arenophilic gland, frontal section. Zenker's fluid, Groat's hematoxylin. Horizontal field width = 120  $\mu\text{m}$ . FIG. 5. *Lyonsia pugetensis*. Densely situated arenophilic glands along mantle edge, frontal section. Formalin, ethanol, Groat's hematoxylin. Horizontal field width = 590  $\mu\text{m}$ . FIG. 6. *Lyonsia californica*. Arenophilic glands along posterior siphonal epithelium, cross-section. Zenker's fluid, Pantin modification. Horizontal field width = 425  $\mu\text{m}$ .

mantle edge when extended. Protrusion of the glands in *L. gouldii* or *L. pugetensis* gives the mantle edge a tentaculated appearance (Fig. 4). Eversion of the glands probably occurs via hydrostatic pressure as numerous hemocoelic spaces pervade the mantle tissues of lyonsiids.

The arenophilic glands of *Lyonsia* are variable in size and number (Fig. 5). They range from an overall length of 75  $\mu\text{m}$  and diameter of 22  $\mu\text{m}$  in *L. floridana*, to 970  $\mu\text{m}$  long and 90  $\mu\text{m}$  wide in *L. pugetensis*. *Lyonsia floridana*, a small lyonsiid rarely exceeding 15 mm in length, has only a few arenophilic glands situated along its mantle edge. *Lyonsia pugetensis*, on the other hand, reaches overall lengths exceeding 50 mm and may possess well over 100 pairs of arenophilic glands densely packed along its mantle edge (Fig. 5). The glands in many species of *Lyonsia* are evenly distributed along the mantle edge and are often found in alignment with fine, radial striations of the periostracum. Sand frequently adheres along these periostracal striae as a reflection of this one-to-one relationship of gland to external shell ornamentation. Arenophilic glands are often concentrated along the siphonal margin and over 40 glands may surround these small atria in adult *L. californica* (Fig. 6). Most museum specimens of *Lyonsia* that were examined (including *L. arenosa*, *L. flabellata*, *L. nesiotis* and *L. norvegica*) plus the specimens used in this study, retained at least some adherent particles, especially ventrally and along the siphonal border (Fig. 7).

The arenophilic mantle glands of *Entodesma* do not open into the periostracal groove and the surrounding epithelial sheath



FIG. 7. *Lyonsia pugetensis*. Shells with peripheral sand cover. Shell length = 28 mm.

is not a modification or extension of the middle mantle fold. Instead, the glands, which are still an elaboration of the outer mantle fold epithelium, open distal to the periostracal groove, and the surrounding sheath is an extension of the outer mantle fold (Fig. 1). The glandular secretion obviously cannot be immediately emplaced above the periostracum as it is in *Lyonsia*. The arenophilic gland secretion in *Entodesma*, which also is produced as a thin, cylindrical thread, pierces the periostracum intermittently (Figs. 1, 8), and emerges as small threads, webs or tufts, radially aligned along the periostracum. In section, it is readily seen that the periostracum is distinctly interrupted at the point of glandular secretion. This interruption produces a pore through which the arenophilic gland secretion emerges. The pore is not preformed but is a result of contact with the gland secretion.

The arenophilic glands of *Entodesma* are never as abundant as they are in *Lyonsia*. A specimen of *E. beana* 15 mm long, for example, may have only five pairs of glands; three along the siphons and two along the pedal gape. There is some indication that the glands may quantitatively regress with growth or age in some members of the genus. Thus, older or larger specimens tend to have fewer arenophilic glands than smaller, juvenile specimens. A specimen of *E. chilensis* 8 mm long has 11 pairs of glands while a specimen 25 mm long has only 2 pairs that are situated along the pedal gape. Similar evidence for this regression, or at least for quantitative variability, has been found in a small growth series of *E. saxicola* (Table 2).

Aside from gross differences in location and sheath composition, the arenophilic glands of *Lyonsia* and *Entodesma* are quite similar. They are club-shaped organs, cylindrical in cross-section, and surrounded by a secretory

TABLE 2. Examination of mantle edge of a small growth series of *Entodesma saxicola* indicating a possible quantitative regression of arenophilic glands with overall size (length) of the clam.

Size (length in mm)	Total number of glands
29	40
36	36
36	35
44	23
50	25
58	13
63	23

sheath (Figs. 9, 10). A thick secretion emerges from the glandular system, initially confined between the central gland and the surrounding sheath, and eventually emerges, through an invagination of the outer mantle fold, above the periostracum.

The glands of *Entodesma* usually, though not always, occur in pairs along the mantle edge and, in many species, are most abundant along the pedal gape. This concentration of glands was especially evident in some of the larger species of *Entodesma* (*E. saxicola*). In some species, such as *E. chilensis*, the glands are also aligned with radial striations of the periostracum. In a specimen of *E. chilensis* 8 mm long, radial periostracal striations are situated 0.706 mm apart at the ventral shell edge. Arenophilic glands of this speci-

men average 0.727 mm apart along the mantle edge. Sand adheres along the radial striations of *E. fretalis* as well and a specimen 16 mm long has about 14 pairs of glands.

Thin retractor-like muscles are present in most species of *Entodesma* that were examined but the protrusion of glands was never evident.

Species of *Entodesma* are usually thicker-shelled and larger than *Lyonsia*. The arenophilic glands, however, do not reflect this difference in overall size. They range from 92  $\mu\text{m}$  long and 30  $\mu\text{m}$  in diameter in *E. beana* to 540  $\mu\text{m}$  long and 32  $\mu\text{m}$  in diameter in *E. saxicola*. The latter species is one of the largest species of *Entodesma* while *E. beana* is relatively small for this genus. The largest lyonsiid species do tend to have the largest

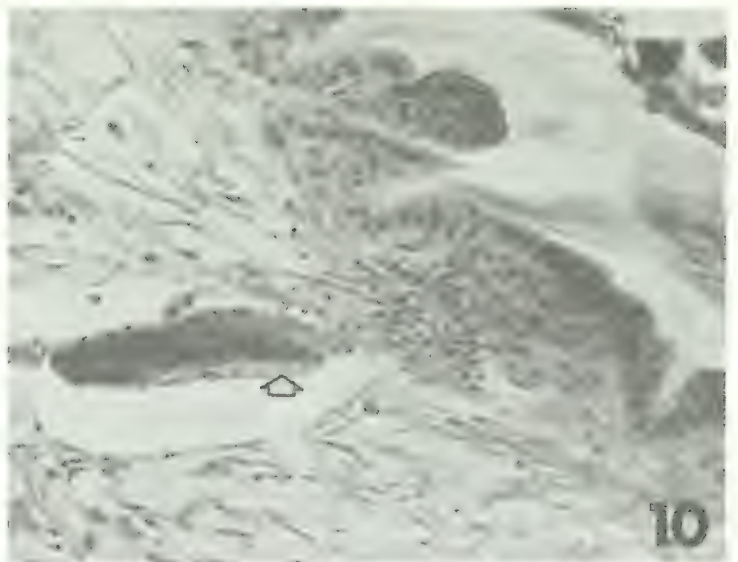
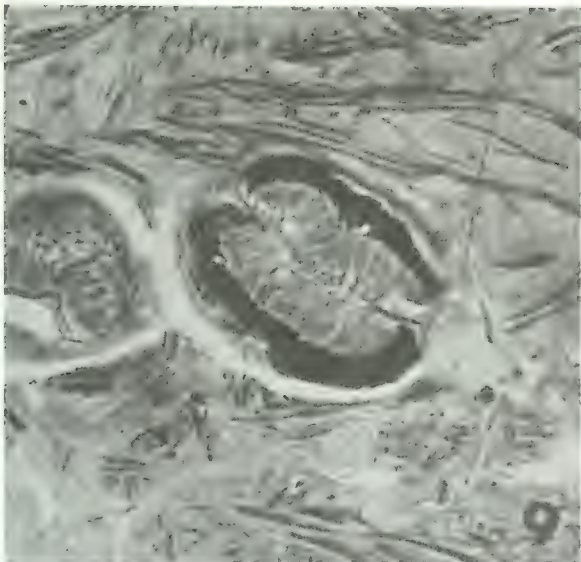

FIG. 8. *Entodesma saxicola*. Arenophilic gland secretion (arrow) penetrating periostracum, longitudinal section. Hollande's fluid, Pantin modification. P, periostracum. Horizontal field width = 95  $\mu\text{m}$ . FIG. 9. *Entodesma saxicola*. Arenophilic gland (section primarily through type 2 cells) with thick, darkly staining, surrounding secretory layer, frontal section. Zenker's fluid, Pantin modification. Horizontal field width = 65  $\mu\text{m}$ . FIGURE 10. *Entodesma chilensis*. Arenophilic gland, longitudinal section. Space surrounding gland is fixation artifact. Gland secretion at arrow. Zenker's fluid, Azan. Horizontal field width = 80  $\mu\text{m}$ .

mantle glands, but much variation in size of the glands exists in medium sized species.

The third marine genus of lyonsiid, *Mytilimeria*, found embedded within compound ascidians, lacks arenophilic radial mantle glands in specimens 6 mm long and larger. Specimens smaller than this have not been examined.

#### General histology

The arenophilic mantle gland system, in both *Lyonsia* and *Entodesma*, is composed of three primary secretory cell types (Figs. 11–13). The club-shaped central gland basically consists of two cell types while the third primary secretory cell constitutes parts of the surrounding sheath. In cross-section the central arenophilic glands are C-shaped (Figs. 13, 14), the open end being the region of merger between the central gland and the surrounding sheath (Fig. 13). The two primary, central cells often form a pseudostratified epithelium when viewed in mid-longitudinal section (Fig. 11). Cell type 1, roughly ovoid or triangular in shape, stain basophilically, have small round, central nuclei with single nucleoli, and are packed with deeply staining granules. These cells either taper towards the broad surface periphery of the gland (Fig. 11) and thus appear bluntly triangular, or are ovoidal or goblet-shaped in section and do not make contact with the latter surface. These cells sometimes show a dense accumulation of large vacuoles that fill most of the intracellular area. A dense array of fine granules is more common. Both conditions are especially evident in *L. californica* and probably represent different stages of secretion maturity. Type 1 cells are near the open end of the C-shaped central gland. At this merger zone the central gland consists of a series of bluntly ovoid cells that are similar to type 1 cells but may stain even more basophilically. These cells usually have a central or basal ovoid nucleus with a single nucleolus, and a high concentration of deeply staining secretory granules. These cells, also categorized as type 1 cells, form the basic juncture cell between the central gland and the sheath cells in both *Lyonsia* and *Entodesma*.

The central gland is always dominated by flask-shaped or tall triangular cells which taper proximally within the organ (Figs. 11–13, 15). These cells are termed cell type 2. The cells are deeply basophilic, have small round or ovoid nuclei with single nucleoli and

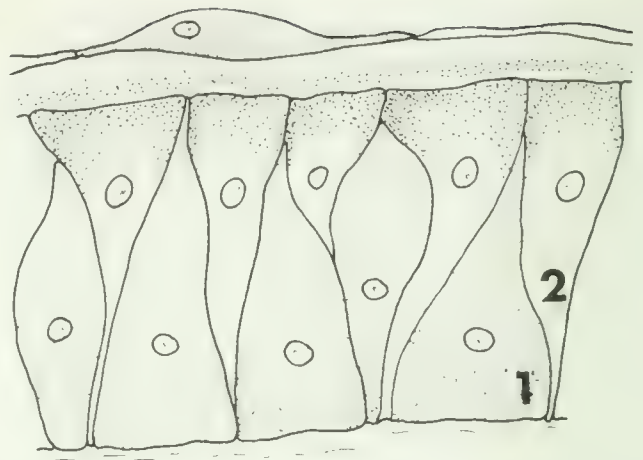

FIG. 11. *Lyonsia californica*. Diagrammatic representation of longitudinal section through portion of arenophilic gland. Cell type 1 and 2 are clearly shown. Spindle-shaped swelling of surrounding sheath forms outer wall and source of gland secretion (stippled area outside cells). Horizontal diagram width = 25  $\mu\text{m}$ .

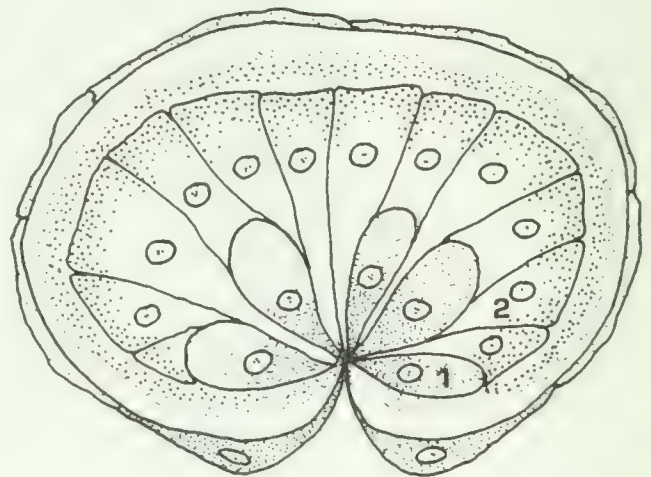

FIG. 12. *Entodesma beana*. Diagrammatic cross-section through arenophilic gland. Horizontal diagram width = 32  $\mu\text{m}$ .

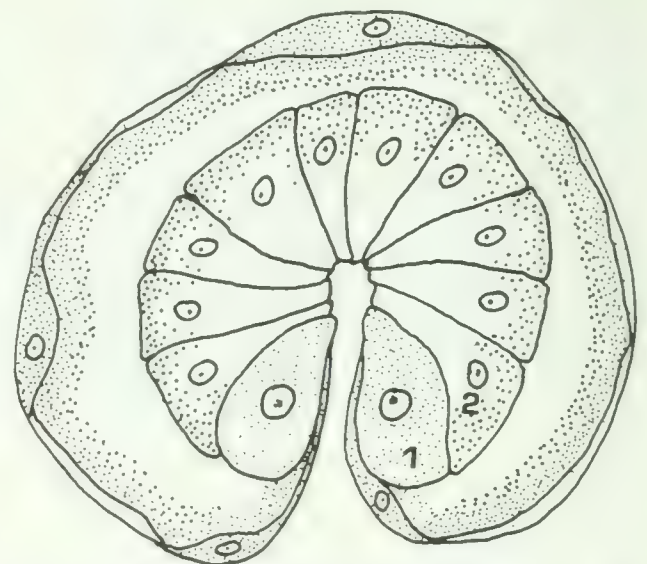

FIG. 13. *Entodesma chilensis*. Diagrammatic cross-section through arenophilic gland. Horizontal diagram width = 30  $\mu\text{m}$ .

often alternate along a longitudinal medial plane, with the shorter, less regular type 1 cells forming the pseudostratification. Type 2 cells rarely show large secretory granules within the cytoplasm in histological sections, but often have fine granules concentrated along their external border.

Maximum width of type 2 cells range from 3–7  $\mu\text{m}$  depending upon species and exact location in the gland. Merger of the central gland and the surrounding sheath occurs along the cross-sectional open end of the C, which is directed away from the inner epithelium of the outer fold. The juncture cells are usually of equal width to the widest of the other central gland cells.

The sheath, derived from the middle fold in *Lyonsia* and the outer fold in *Entodesma*, is confluent with the juncture cells. This thin surrounding epithelium is composed of flat squamous cells that irregularly form bulbous or spindle-shaped cells (Fig. 13) that usually contain a circular nucleus with a single nucleolus and a dense, basophilic cytoplasm. The latter is often perfused with deeply staining secretory granules. The spindle-shaped cells of the sheath are especially evident at the region of merger or confluence between the central gland and the sheath. The encircling sheath was previously reported as being a retaining layer in *L. hyalina* (Prezant, 1979a). The thick secretion surrounding the central gland and medial to the sheath, however, is the compound result of joint secretory activities from both tissues. The secretion is bilayered as a result of bi-directional secretory activities. The thick, inner layer of secretion is produced by type 2 cells which dominate the central gland while the thinner outer secretory layer is produced by the sheath cells and the ovoid or bluntly triangular type 1 cells of the central gland.

Cellular distinctions are readily evident in species of *Lyonsia* which possess numerous, large glands. Arenophilic glands of *L. pugetensis* show very tall and thin type 2 cells that measure 45  $\mu\text{m}$  by 4  $\mu\text{m}$ , and possess a central ovoid nucleus that fills most of the width of the cell and 6  $\mu\text{m}$  of its length. Type 1 and 2 cells of *L. pugetensis* sporadically alternate along the longitudinal-medial plane of the central gland. Type 1 cells of this species are deeply basophilic, range in height from 10–20  $\mu\text{m}$ , and have small central nuclei. These cells do not taper into an extended, narrow neck that reaches the broad gland surface. Contrary to this, the two primary cell types of

the central gland of *L. californica* alternate along the medial-longitudinal plane of the central gland and both cells extend the entire 18  $\mu\text{m}$  height so that the broad apical surface of type 2 cells lie next to the thin, tapered neck of type 1 cells. This, in effect, produces a pseudostratified columnar epithelium. This type of central gland is found in *L. floridana*, *L. gouldii*, and *L. hyalina*.

While glands of members of the genus *Lyonsia* open just behind the periostracal groove cells, arenophilic glands of *Entodesma* may open some distance distal to the typically small periostracal groove (Figs. 1, 16–17). In *Entodesma chilensis* the arenophilic glands open about 400–500  $\mu\text{m}$  away from the periostracal groove. The glands of this species show the usual type 1 cells which are roughly triangular and have thin extensions leading to the broad surface of the central gland, are 14  $\mu\text{m}$  tall and 5  $\mu\text{m}$  wide at their inner edge and have small, round nuclei. Type 2 cells of *E. chilensis* are flask-shaped with a broad peripheral surface and a central ovoid nucleus with a single nucleolus (Fig. 13).

Cells of the central gland show some plasticity in overall sizes, as seen in *Entodesma patagonica*. In this species the cells of the central gland along most of its length are about 15  $\mu\text{m}$  tall. At the internal border of the central gland, the cells reach heights of 25  $\mu\text{m}$ . Variation in size of type 1 cells especially in width is common. This is likely a result of various maturation stages of secretions in these mucocyte-like cells.

#### *Ultrastructure and histochemistry*

The ultrastructure and histochemistry of the central gland and sheath cells confirm their active secretory nature. For the most part, each species showed similar ultrastructure (Figs. 18–19) and histochemical reactions. Results of the histochemical tests are shown in Table 3. Briefly, type 1 cells stain beta metachromatically with toluidine blue (Fig. 20) and give strong positive reactions for: alcoholic periodic acid Schiff stain (with and without diastase); alcian blue at pH 1.0 and 2.5 (Fig. 20), alcian blue with critical electrolyte levels ranging from 0.2 to 0.8 M magnesium chloride (Fig. 22), and give trace positive reactions for alcian blue at a 1.0 M electrolyte level, ninhydrin Schiff, and bromphenol blue. These reactions indicate a weakly acidic mucopolysaccharide with a small protein com-

ponent. Similar results were reported for *Lyonsia hyalina* (Prezant, 1979a). These cells have a prominent Golgi complex. In *L. californica* the Golgi complex has a deeply concave face and up to 14 cisternae which contain an electron dense material (Fig. 23). The Golgi complex, variously located but often prominent basally or just next to the nucleus with the mature face directed towards the nucleus, pinches off numerous small vesicles which condense into large vacuoles just next to the Golgi complex (Fig. 24). The Golgi apparatus of type 1 cells in *Entodesma saxicola* are typically composed of fewer and straighter cisternae than in *L. californica*. Type 1 cells also have a dense population of rough endoplasmic reticula, a smaller amount of smooth endoplasmic reticula, numerous small round or ovoid mitochondria, and an electron dense, grainy cytoplasm.

Previously, type 2 cells were thought to be supportive cells (Prezant, 1979a); current research shows they are secretory as well. Type 2 cells are histochemically distinct from type 1 cells. Type 2 cells stain positively for alcoholic periodic acid Schiff (with and without diastase) (Fig. 21), ninhydrin Schiff, bromphenol blue, dihydroxy-dinaphthyl-disulfide,

mercury orange, and the latter two stains with thioglycerol. These reactions indicate a highly proteinaceous secretory component with disulfide groups and a minor carbohydrate component. The secretion from type 2 cells is probably a glycoprotein. The external border of type 2 cells bears a dense array of microvilli. The microvilli of *Lyonsia californica* and *L. floridana* (Fig. 25) are similar to those of *L. hyalina* (Prezant, 1979a) in that they are short, squat and irregular. The microvilli of type 2 cells of *Entodesma saxicola* are discrete units which reach lengths of 0.6  $\mu\text{m}$  (Fig. 26). They are uniformly distributed along the exposed cell surface and are of relatively equal dimensions. Electron dense secretory granules in type 2 cells of *Lyonsia californica* indicative of exocytosis (Fig. 27). Type 2 cells are often packed with large, osmophilic secretory vacuoles and granules, especially prevalent in *E. saxicola* (Fig. 28). Secretory granules in type 2 cells of *Lyonsia californica* and *L. floridana* are always smaller than those in *Entodesma*. Type 2 cells also possess a small Golgi complex, numerous small mitochondria located especially above the nucleus, numerous free ribosomes and a less electron dense cytoplasm than that present in cell

TABLE 3. Summary of the histochemical reactions carried out on the arenophilic mantle gland system of *Lyonsia californica*. Similar results were found for *L. floridana* and *Entodesma saxicola*. Abbreviations: -, no reaction; tr, trace reaction; +, positive reaction; ++, very strong positive reaction; ab, alcian blue positive; pas, periodic acid Schiff positive; CEC, critical electrolyte concentration; DDD, dihydroxy-dinaphthyl-disulfide.

Histochemical test	Central gland cells		Sheath cells	Secretory layer	
	Type 1	Type 2		Inner	Outer
Toluidine blue (metachromasia)	beta	alpha	beta	beta	beta
PAS (alc.)	++	+	+	tr	+
PAS/diastase	++	+	+	tr	+
Alcian blue, pH 1.0	+	-	+	-	+
Alcian blue, pH 2.5	+	-	+	-	+
Alcian blue, pH 5.7					
CEC 0.1 M	+	-	+	-	+
CEC 0.2 M	++	-	+	-	+
CEC 0.4 M	++	-	+	-	+
CEC 0.5 M	++	-	+	-	+
CEC 0.6 M	++	-	+	-	+
CEC 0.8 M	+	-	+	-	+
CEC 1.0 M	tr	-	tr	-	tr
Alcian blue, pH 2.5/PAS	ab	pas	ab	tr pas	ab
Ninhydrin Schiff	tr	++	tr	++	+
Bromphenol blue	tr	++	tr	++	tr
Mercury orange	-	++	-	+	-
Mercury orange/thioglycerol	-	++	-	+	-
DDD	-	tr	-	-	-
DDD/thioglycerol	-	tr	-	+	-



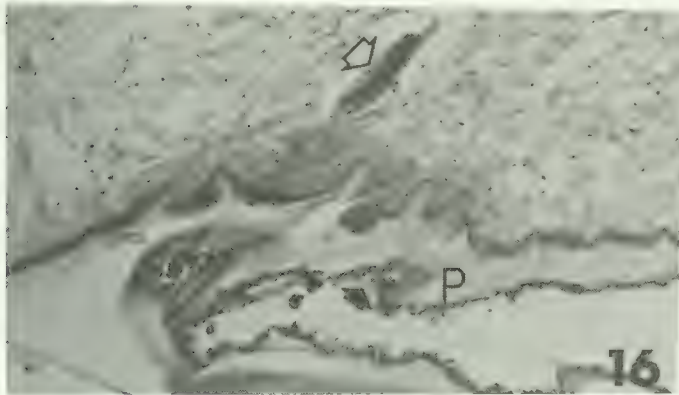
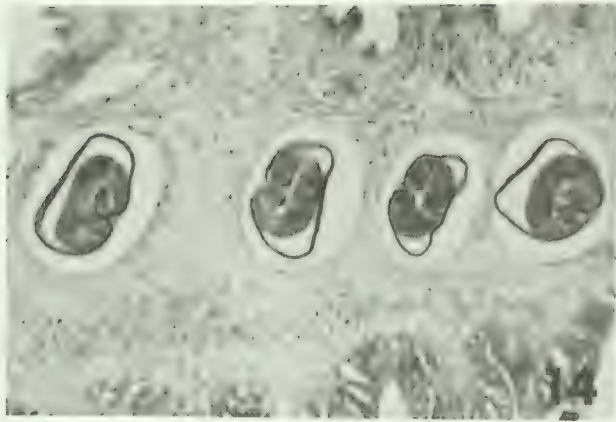

FIG. 14. *Lyonsia californica*. Closely set arenophilic glands, cross-section. Gland secretion forms dark layer around each central organ. Zenker's fluid, Pantin modification. Horizontal field width = 45  $\mu\text{m}$ . FIG. 15. *Entodesma saxicola*. Type 2 cell domination of arenophilic gland, frontal section. Thick secretory layer surrounds central gland. Zenker's fluid, Pantin modification. Horizontal field width = 35  $\mu\text{m}$ . FIG. 16. *Entodesma chilensis*. Arenophilic gland (open arrow), longitudinal section. Debris adhering to periostracum is evident (closed arrow). P, periostracum. Zenker's fluid, Pantin modification. Horizontal field width = 750  $\mu\text{m}$ . FIG. 17. *Entodesma fretalis*. Arenophilic gland opening (open arrow) ventral to periostracal groove cells, periostracal groove at arrow, cross-section of mantle edge. Formalin, ethanol, basic fuchsin and fast green. Horizontal field width = 265  $\mu\text{m}$ .



FIG. 18. *Lyonsia californica*. Transmission electron micrograph of arenophilic gland, frontal section. 1, cell type 1; 2, cell type 2; S, sheath cell; arrow, gland secretion. Horizontal field width = 50  $\mu\text{m}$ . FIG. 19. *Lyonsia californica*. Transmission electron micrograph of arenophilic gland, longitudinal section. Type 1 cells show large secretory vesicles. 1, cell type 1; 2, cell type 2; s, sheath cell; arrow, gland secretion. Horizontal field width = 25  $\mu\text{m}$ .

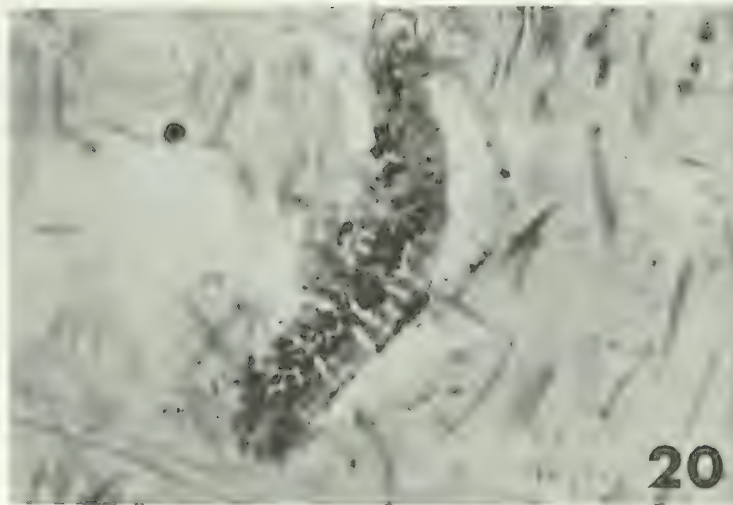

FIG. 20. *Lyonsia gouldii*. Arenophilic gland, frontal section showing metachromasia of cell type 1. Formalin, ethanol, toluidine blue. Horizontal field width =  $85\ \mu\text{m}$ . FIG. 21. *Lyonsia californica*. Arenophilic gland, frontal section. Medial cells type 1 react positively to alcian blue, laterally placed cells type 2 react positively to PAS; secretion barely reactive. Rossman's fluid, alcian blue pH 2.5 and PAS. Arrow, gland secretion. Horizontal field width =  $80\ \mu\text{m}$ . FIG. 22. *Lyonsia californica*. Arenophilic gland, frontal section. Cells type 1 and sheath cells give strong positive reaction to alcian blue at critical electrolyte level of 0.5 M. Rossman's fluid. Horizontal field width =  $135\ \mu\text{m}$ .

type 1. The nucleus of type 2 cells has densely staining, widely dispersed chromatin material. The commanding aspect of type 2 cells is the very dense concentration of rough endoplasmic reticulum (Fig. 29). The rough endoplasmic reticulum of the cells in *L. californica* usually occur as tightly packed parallel cisternae. The reticulum is dispersed throughout the cytoplasm of type 2 cells but the parallel arrangement of cisternae is especially prevalent next to the nucleus in *L. californica*. Round, vesicular-like sections of the rough endoplasmic reticulum are dispersed throughout the cytoplasm of type 2 cells of *E. saxicola*. The Golgi complex of type 2 cells in *L. californica* has a concave face but is composed of only 5 or 6 cisternae. An electron dense material fills the Golgi cisternae and small, electron dense vesicles are evidently pinched off. The Golgi complex of type 2 cells

usually occurs supranuclearly. The Golgi complex of type 2 cells of *E. saxicola* (Fig. 30) is less prominent than in *L. californica*. In the former, the Golgi apparatus appears as a small system of straight lamellae that pinch off electron lucent vesicles that gradually increase in density. Some of the large secretory granules in the type 2 cells of *E. saxicola* possess microlamellar inclusions that form a fingerprint or paracrystalline pattern within the electron dense structure (Fig. 31). In cell type 2 of *E. saxicola*, a large, multivesicular body was found just below the cell surface and above the previously described secretory granule (Fig. 30) in one series of sections. The secretory granule was typically surrounded by rough endoplasmic reticulum and was often capped by an electron lucent vacuole. In all observed stages, the granule or vacuole is surrounded by a somewhat less



FIG. 23. *Lyonsia californica*. Transmission electron micrograph of type 1 cell Golgi complex. Note small membrane enclosed granules pinched off from ends of sacs and large vesicles above Golgi. Horizontal field width =  $2.5 \mu\text{m}$ . FIG. 24. *Lyonsia californica*. Transmission electron micrograph of basal regions of type 1 cells. g, Golgi complex; m, mitochondrion; n, nucleus; v, vesicle. Horizontal field width =  $7.5 \mu\text{m}$ . FIG. 25. *Lyonsia floridana*. Transmission electron micrograph of arenophilic gland secretion. Arrow indicates division in secretory layers. Horizontal field width =  $10.5 \mu\text{m}$ . FIG. 26. *Entodesma saxicola*. Transmission electron micrograph of outer region of type 1 cell. Secretory layer is obviously biphasic outside microvilli. Horizontal field width =  $5 \mu\text{m}$ . FIG. 27. *Entodesma saxicola*. Transmission electron micrograph. Exocytotic release of two secretory granules from cell type 2 of arenophilic gland. Note homogeneous electron density of secretory granules and inner secretory layer. Horizontal field width =  $1.7 \mu\text{m}$ .

electron dense cytoplasm that in turn is surrounded by a single membrane (Fig. 30). During some phases of this granule development the secretory material condenses into an electron dense substance with internal micro-lamellae. This type of system is seen only rarely in type 2 cells and may be indicative of lysosomal activity.

The cells of the central gland are joined by numerous desmosomes (Fig. 32). These areas of cell attachment are usually most noticeable near the gland periphery. The intercellular space is approximately  $220 \text{ \AA}$ .

The sheath cells for the most part are very thin, but irregularly, and always at the juncture with the central gland, become spindle-shaped (Figs. 28, 33–35). These spindle-shaped cells show histochemical similarities to type 1 cells and, based on these properties, may secrete the same substance. The

spindle-shaped sheath cells have a grainy cytoplasm filled with a high concentration of rough endoplasmic reticulum, numerous small round or ovoid mitochondria and, in *Lyonsia californica*, at least some regions are filled with a dense array of microfibrils that run normal to the cell surface (Fig. 36). These microfibrils appear to be composed of electron dense granules which are closely aligned and abut upon the external secretory layer. The secretory surface of the sheath cells of *Entodesma saxicola* bears an irregular, short microvillar border (Fig. 28). In *E. saxicola* the sheath cells show numerous membrane bound secretory granules with concentric fibril lamellations as seen rarely in type 2 cells of this species (Figs. 37–38). The fine fibrils, that compose the lamellae within the secretory granule circumscribe the large, mature vacuole and seem to form a bounding, multi-

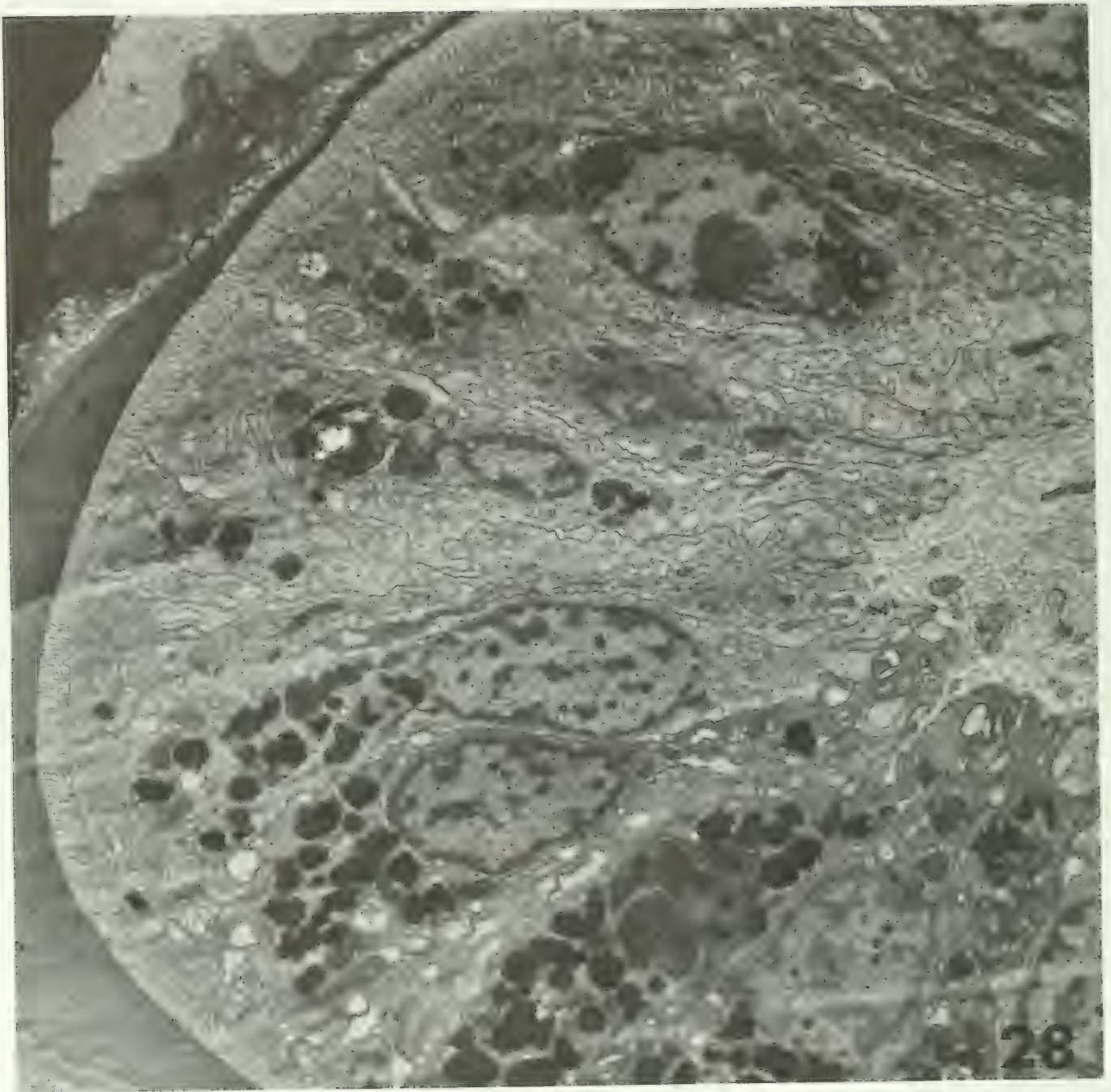

FIG. 28. *Entodesma saxicola*. Transmission electron micrograph showing electron dense secretory granules of type 2 cells, note secretory granule emerging from sheath cell (arrow). Horizontal field width = 15.5  $\mu\text{m}$ .

layered coat around the central mass of heterogeneous, grainy material. The individual electron dense fibrils are less than 55 Å wide. These sheath cell granules are less homogeneous than similar granules of type 2 cells. Granules of this sort, emerging from the sheath cells, have been found among the microvilli of these cells.

The secretion produced by the arenophilic gland system is composed of two distinct layers; an electron dense inner layer produced by type 2 cells, and a less electron dense outer layer produced by type 1 cells and sheath cells (Figs. 25–27, 39). Type 1 cells secrete along the entire concave portion (in cross-section) of the central gland, and its

secretion merges with the sheath cell secretion and is deposited above the thicker, denser, cell type 2 secretion. The inner glycoproteinaceous layer is homogeneous in *Entodesma saxicola* and somewhat more grainy in *Lyonsia californica* and *L. floridana*. The outer secretory layer is always thinner and in *E. saxicola* shows a dense array of microlamellae, irregularly present within the grainy matrix (Figs. 40–41). These fibrils are similar to the microfibrils present within the sheath cell secretory granules. Fibrils in the secretion appear almost membranous or similar to thin, elongated microtubules. These usually, but not consistently, run normal to the gland surface along the outer secretion and

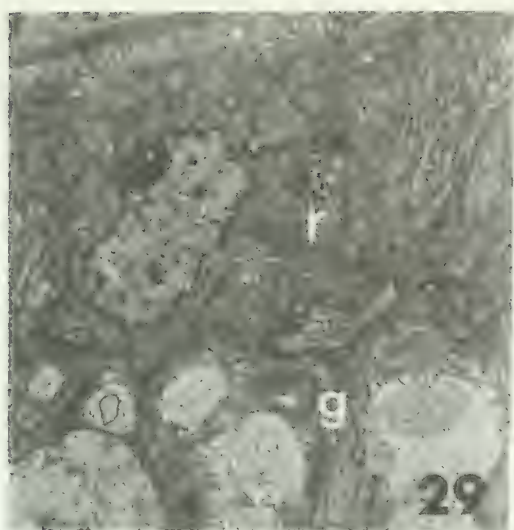

FIG. 29. *Lyonsia californica*. Transmission electron micrograph of type 2 cells (upper region of micrograph) and portion of type 1 cells. Note dense array of rough endoplasmic reticula near nucleus of type 2 cell and large Golgi complex of type 1 cells. g, Golgi; r, rough endoplasmic reticula. Horizontal field width =  $7.7 \mu\text{m}$ . FIG. 30. *Entodesma saxicola*. Transmission electron micrograph illustrating micro-lamellar inclusions of secretory granules (open arrow) of type 2 cells. b, multivesicular body. Horizontal field width =  $3.8 \mu\text{m}$ . FIG. 31. *Entodesma saxicola*. Transmission electron micrograph of secretory granule with micro-lamellar inclusion in type 2 cell. Horizontal field width =  $1.1 \mu\text{m}$ . FIG. 32. *Entodesma saxicola*. Transmission electron micrograph of central gland and sheath cells. Note microvillar border on either side of secretory layer. d, desmosome; s, sheath cell; arrow, glandular secretion. Horizontal field width =  $9 \mu\text{m}$ .

exhibit a periodicity of about  $130 \text{ \AA}$ . The fibrils of the secretory granules in the sheath cell are more tightly packed together than those found extracellularly.

The dual nature of the secretion is obvious in most specimens examined ultrastructurally. The inner secretory layer (i.e., the glycoprotein layer) exceeds  $2 \mu\text{m}$  in thickness in *Entodesma saxicola* while the outer (i.e., mucopolysaccharide) layer is usually less than  $0.8 \mu\text{m}$  thick. The outer layer in *Lyonsia californica* is less than  $0.01 \mu\text{m}$  thick while the inner glycoprotein layer is about  $0.2 \mu\text{m}$  thick. The outer layer of *L. floridana* averages less than  $0.5 \mu\text{m}$  in thickness while the inner layer is just over  $2 \mu\text{m}$  thick. In the latter

species the two layers are difficult to distinguish since both have approximately equal electron density (Fig. 25), but a fine line separates the two layers. This is reminiscent of the vague separation of secretory layers in *L. hyalina* (Prezant, 1979a).

A large nerve trunk runs along the region of merger between the central gland and the sheath in *Lyonsia californica* (Fig. 34). This trunk measures about  $8.6 \mu\text{m}$  wide by  $3.2 \mu\text{m}$  tall. A similar neural bundle, showing numerous axons with synaptic vesicles, runs longitudinally along the sheath cells of *Entodesma saxicola*. Details of the potential nervous innervation of the arenophilic glands were not obtained.

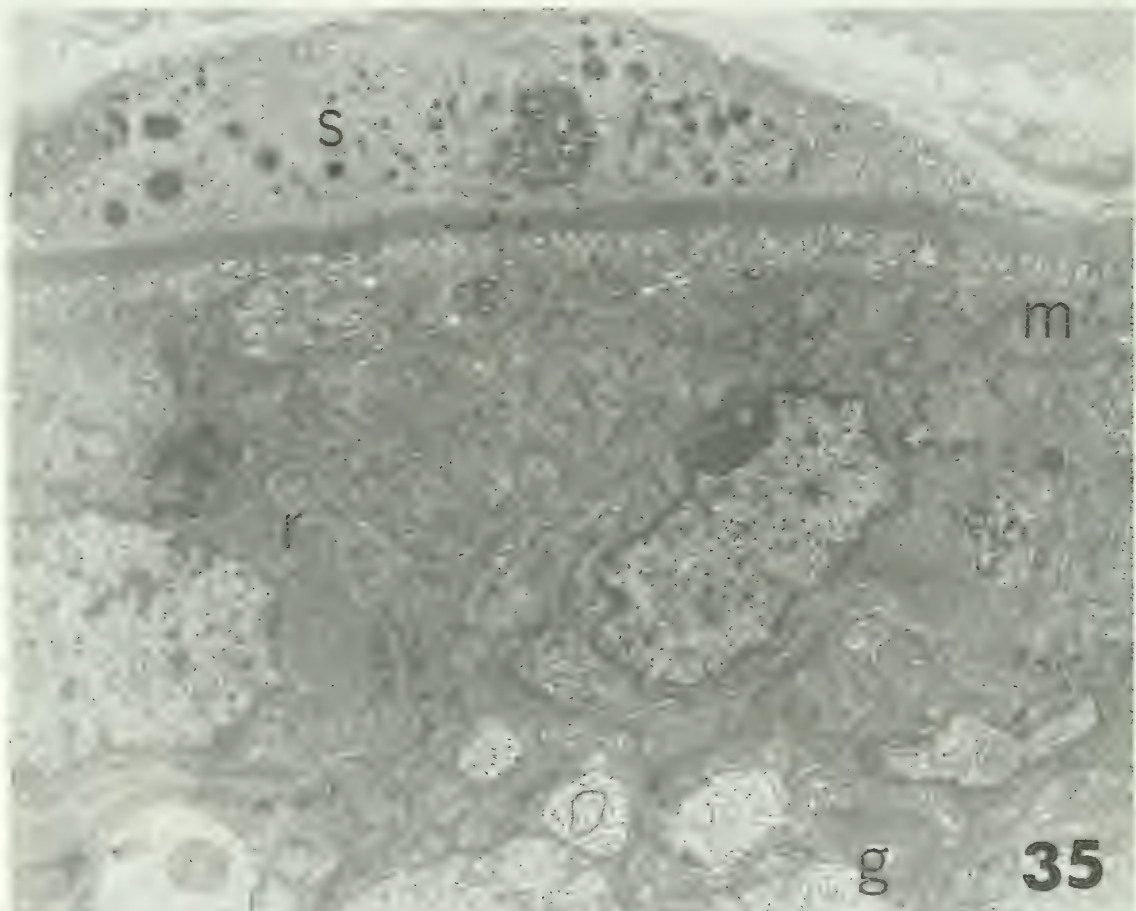
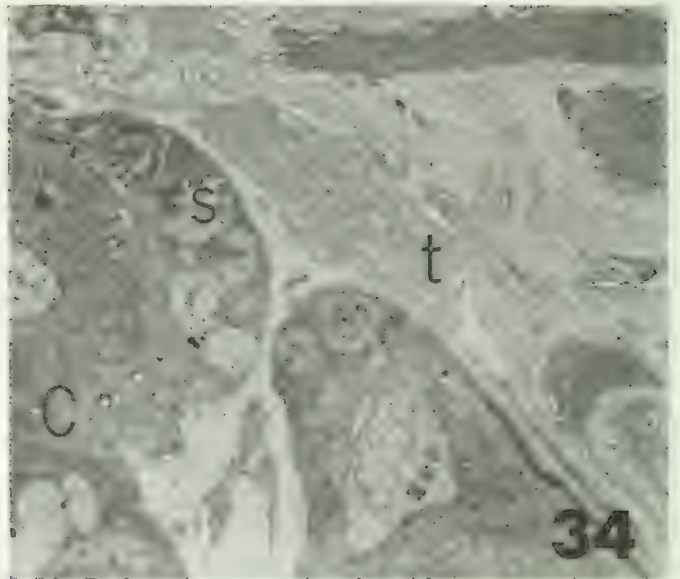

FIG. 33. *Entodesma saxicola*. Transmission electron micrograph of sheath cell. s, sheath cell; arrow, glandular secretion. Horizontal field width =  $16.7 \mu\text{m}$ . FIG. 34. *Lyonsia californica*. Transmission electron micrograph showing merger of sheath cells and central gland at ovoid border cell. Nerve trunk runs along this region of merger. C, central gland; s, sheath cell; t, nerve trunk. Horizontal field width =  $17.4 \mu\text{m}$ . FIG. 35. *Lyonsia californica*. Transmission electron micrograph of sheath cell and periphery of central gland. g, Golgi; m, mitochondrion; r, rough endoplasmic reticular; s, sheath cell. Horizontal field width =  $10.5 \mu\text{m}$ .

#### *Sediment replacement*

Five weeks after the shells of selected individuals had been cleared of adhering sediment and the animals had been replaced in a fine, sand substratum, both *Lyonsia floridana*

and *L. californica* attached new sand grains along the ventral periphery of their shells. Reattachment of sediment reflected new periostracal growth; sand adhered only to the newly grown region. *Entodesma saxicola* under similar conditions, emplaced only a few

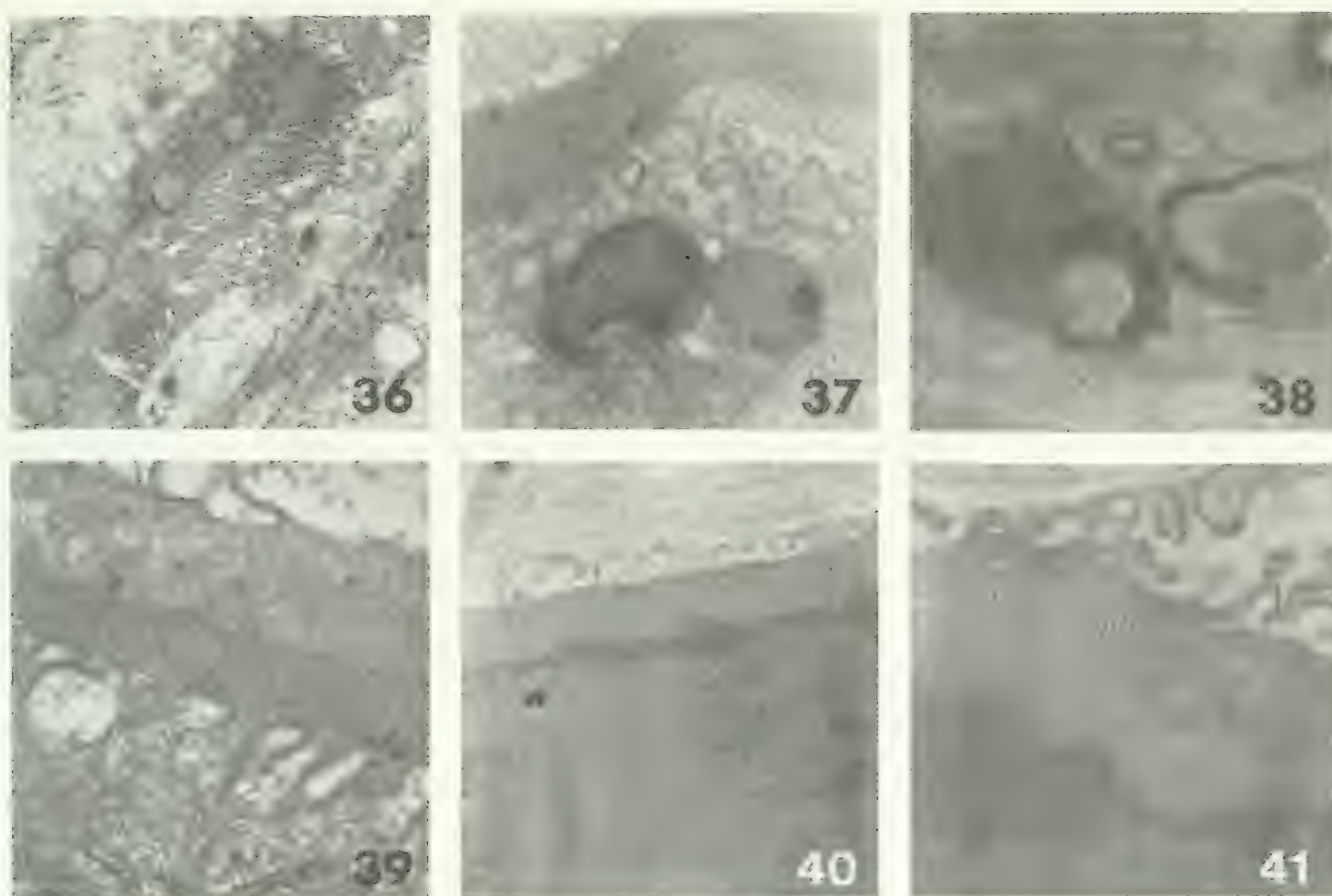

FIG. 36. *Lyonsia californica*. Transmission electron micrograph of granular fibrils surrounding portions of outer secretory layer in sheath cells. Horizontal field width =  $2\ \mu\text{m}$ . FIG. 37. *Entodesma saxicola*. Transmission electron micrograph of secretory granules with micro-lamellar inclusions among microvilli of sheath cells. Horizontal field width =  $1.6\ \mu\text{m}$ . FIG. 38. *Entodesma saxicola*. Transmission electron micrograph of secretory granules with micro-lamellar inclusion within sheath cell. Horizontal field width =  $1.2\ \mu\text{m}$ . FIG. 39. *Lyonsia californica*. Transmission electron micrograph of biphasic secretion. Note fibrils in surrounding sheath. Horizontal field width =  $1.7\ \mu\text{m}$ . FIG. 40. *Entodesma saxicola*. Transmission electron micrograph of biphasic secretion. Note electron dense inner secretory layer and less dense, lamellated outer layer. Horizontal field width =  $2.5\ \mu\text{m}$ . FIG. 41. *Entodesma saxicola*. Transmission electron micrograph showing micro-lamellations of outer secretory layer. Horizontal field width =  $1.1\ \mu\text{m}$ .

sand grains mainly along the siphonal and pedal gape regions of the shell. Specimens of *Mytilimeria nuttalli* from various size classes (the smallest being 6 mm long at start of the five week experiment) grew close to 3 mm by the end of this period. No specimen showed any indication of sediment adhesion during or after the experimental time.

#### DISCUSSION

Adhesion of sediments to the shell is not unique to the Lyonsiidae. *Samarangia quadrangularis*, a venerid bivalve, for example, deposits discretely sculptured patterns of sand over its shell surface (Clench, 1942). Many gastropods as well, particularly among the xenophorids, are able to decorate their shells with foreign materials. Even land snails of the family Sagdidae cement debris to their shell, probably for protection (Clench, 1942).

These molluscs, however, incorporate extraneous matter into the calcareous shell (*Xenophora*) (Morton, 1958), while the other molluscs may secrete an adhesive mucus from "typical," unicellular pallial mucocytes. Discrete, multicellular organs, producing an external adhesive involved in cementing foreign matter to the periostracum, are known only in lyonsiids and verticordiids.

The Lyonsiidae have undergone a high degree of adaptive radiation with regard to their habitats, as discussed earlier. In each case, the periostracum and associated components play an intricate role in the maintenance of the bivalve within its appropriate microhabitat. The presence or absence of arenophilic glands correlates well with the life styles of the three genera. *Lyonsia* species are attached to the substratum by only a few, weak byssal threads and are often exposed to shifting sediments and tides. All species of *Lyonsia*

possess arenophilic mantle glands that are usually evenly distributed along the entire mantle edge and are particularly concentrated along the siphons. The glands secrete into the periostracal groove and over the periostracum and the sand, which adheres to this surface, adds surface area, provides a protective coat, and adds weight to the shell. The attached sand may play several roles, including stabilizing the bivalve within the substratum, acting as a protective cover, and providing some camouflage. The latter two functions are of special import along the posterior shell surfaces of *Lyonsia*. Here, where glands may be most abundant, attached particles cover extensions of the periostracum that flare out beyond the calcareous shell edge. The siphonal region of shell cannot be fully adducted but upon withdrawal of the siphons, the periostracal flaps fold inward and attached sand grains form an effective operculum over the siphonal gape. This is particularly important in most species of *Lyonsia*. These lyonsiids are typically only partially buried within the substratum, and their siphonal regions would otherwise be exposed to potential predation or silting were it not for the protective sandcover.

Species of *Entodesma* are generally thicker-shelled than *Lyonsia* and also produce numerous, thick, pliable byssi. These features, in conjunction with nestling habits, usually leaves adult bivalves of this genus well secured and protected. Juvenile individuals, on the other hand, are thinner-shelled and may not fit as securely within a given crevice. Smaller *Entodesma* species are also generally thinner shelled than larger members. Juveniles and adults of typically smaller species of *Entodesma*, may possess more arenophilic mantle glands than larger, thicker shelled specimens. Some evidence indicates a quantitative regression of these glands in some species of *Entodesma*. Very large specimens of *Entodesma* rarely have many foreign particles adhering to their shell.

Specimens of *Mytilimeria*, greater than 6.0 mm in length, lack arenophilic mantle glands. The loss of these organs in this genus is understandable. *M. nuttalli* larvae settle on colonies of *Eudistoma psammion* or *Distaplia occidentalis* and the bivalve seems to inhibit growth of the tunicate at the point of settlement (Yonge, 1952). Thus, the ascidian colony grows around the mollusc. The bivalve shell adheres within the tunicate by a "sticky periostracum" (Yonge & Thompson, 1976).

The role of stabilization, protection and camouflage have been "taken over" by the host. The bivalve has in turn evolved cryptic coloration of the siphons to match the tunicate test, a physically adhesive periostracum (Prezant, 1980a), and a method of maintaining an open respiratory and feeding passage through the ascidian.

The fine structure of lyonsiid arenophilic glands suggests their secretory roles and products. The elaborate Golgi apparatus found in type 1 cells of arenophilic mantle glands and the very dense concentrations of rough endoplasmic reticulum in type 2 cells correspond well to previous findings reporting similar secretions. Secretory granules originating from the Golgi complex often signify a high proportion of carbohydrate in invertebrate mucoid secretions (Peterson & Leblond, 1964). The large Golgi complex of the cerebral organ of the nemertean *Lineus ruber*, in conjunction with a high concentration of rough endoplasmic reticula, may indicate a high protein component in the mucus secreted by this organ (Storch & Welsch, 1972). The mucocytes of the cephalic tentacles of the prosobranch *Pomatias elegans* have a dense population of rough endoplasmic reticulum which may give rise directly to mucoid secretory granules (Storch & Welsch, 1972).

The arenophilic gland system of lyonsiids produces two secretory components, a glycoprotein and a weakly acidic mucopolysaccharide, which form a tight unit secretion. The two components probably have separate functions. The thin, outer mucopolysaccharide layer may act as a lubricant to aid in the passage of the more viscous glycoprotein through the glandular inpocketing. Possibly, the mucopolysaccharide component also acts as the initial adhesive for primary particle attachment prior to "tanning" or hardening of the glycoprotein layer which may be responsible for more permanent adhesion. In the case of *Entodesma*, at least one of the secretory components must contain some solvent that permits penetration through the periostracum. This organic solvent is most likely an enzyme, probably a protease. The secretion has not yet been tested for enzymes.

The glycoprotein layer is the more likely candidate for the possession of the potential protease in *Entodesma*. If this is the case, the thin mucopolysaccharide layer may act as a protective shield preventing extraneous perfusion of the enzyme throughout the mantle



epithelium. The viscous nature of the glycoprotein may also help localize the secretion. A similar situation may exist in the oyster-drill, *Urosalpinx cinerea*. In this muricid, the accessory boring organ may contain an enzyme that aids in the dissolution of the periostracum and organic matrix of bivalve shells (Nylen et al., 1969; Carriker, 1969, 1978; Carriker & Williams, 1978). Secretion from the accessory boring organ contains a neutral mucopolysaccharide or mucoprotein. The viscid nature of these substances allows close application of the secretion to the borehole and helps prevent the secretion from running out of the drill site (Carriker et al., 1978). Zottoli & Carriker (1974) also found an external protease released by several species of tube-dwelling polychaetes. This enzyme may be mixed with mucus produced by the worm's epidermis and emplaced on the inner walls of the tube. It may be activated upon exposure to seawater and may prevent fouling of the worm tubes. The accessory boring organ of the prosobranch *Polinices lewisi* consists of two distinct epithelial regions; one producing a mucopolysaccharide and the other a proteinaceous substance (Bernard & Bagshaw, 1969). It is possible that the mucopolysaccharide component acts as a lubricant or seal during boring (Bernard & Bagshaw, 1969) while the proteinaceous component contains the active solvents. This may also, as mentioned, be the case in *Entodesma*, but of course, not for interspecific predation or boring.

Mucocytes within several different taxa contain secretory granules that have dense arrays of microtubule-like structures (Storch & Welsch, 1972). The exact nature of these often paracrystalline components in most cases is not well known, but they are probably protein aggregates (Welsch & Storch, 1976).

While crystalline or microfibrillar inclusions are well known intracellular components occurring within the nucleus, endoplasmic reticulum, mitochondria, Golgi apparatus, secretory granules, or in the cytoplasm of numerous cell types (Welsch & Storch, 1976: 33), the maintenance of fibrillar uniformity following secretion is not. The ventral gland cells involved in production of the secretion of the outer periostracal layer of the shell of *Littorina littorea* possess Golgi granules that contain a material with a distinct periodicity of 300 Å (Bevelander & Nakahara, 1970). The outer periostracum of this gastropod also has a regular periodicity of about 300 Å, although

Beverlander and Nakahara (1970) suggest that ventral gland secretion undergoes a dispersion and reaggregation at discharge. Periodic delineations in the outer secretory layer from the arenophilic glands of *Entodesma saxicola* exhibit a regularity of about 130 Å while granules of the sheath cell have an internal periodicity of less than this. It is likely that reaggregation is also taking place in the arenophilic gland system as there is no evidence of maintenance of periodicity in the secretion during release.

The micro-lamellar or para-crystalline components found within the outer secretory layer produced by the arenophilic glands of *Entodesma saxicola* may offer structural support of this secretion during periostracal penetration. In species of *Entodesma*, the proteolytic portion of the secretion may be short-lived and only active prior to exposure to seawater. Thus, a mechanism probably exists whereby there is a periodic secretion, under nervous control, from arenophilic glands of *Entodesma* during a period of no, or minimal, periostracal growth. The secretion chemically penetrates the periostracum and produces a small adhesive tuft, thread, or web on top of the newly tanned outer organic shell layer. The exact location, or time involved in periostracal tanning in *Entodesma* is not known, but it is likely that the periostracum is tanned prior to penetration by the arenophilic gland secretion. Waite & Wilbur (1976) hypothesized that periostracal polymerization must occur shortly after secretion to avoid environmental dissolution. Reflection of the periostracum over the shell edge would put adhesive components in direct contact with the surrounding environment. The secretion, upon exposure to seawater, probably loses its proteolytic powers but remains adhesive for a short time after. Following this, glands stop secreting and the periostracum, under appropriate conditions, resumes growth. This cycle is repetitive and periodic. Radially situated rows of fine short threads, or tufts regularly dot the periostracal striations of *E. saxicola*, *E. fretalis* and *E. chilensis*.

Within an individual, the presence of discrete secretory organs producing an organic solvent that dissolves its own periostracum appears unique within the bivalves and limited to *Entodesma*. Among gastropods, some spiny muricids have the ability to dissolve parts of their own shell that would otherwise interfere with normal shell growth (Carriker, 1972). Among arthropods, an insect moulting

fluid able to dissolve inner proteinaceous cuticular layers during ecdysis is well known (Wigglesworth, 1972).

A search for arenophilic radial mantle glands in other members of the Anomalodesmata other than Lyonsiidae and Verticordiidae, has thus far proved negative. No comparable organs have been found in the species of *Periploma*, *Thracia*, *Cochlodesma*, *Pandora* and *Laternula* that were examined. It is phylogenetically significant that thus far within this subclass only two families have been found to possess these specialized organs. Allen & Turner (1974) found mantle glands in some Verticordiidae that are quite similar to those of *Lyonsia*. These glands are similarly composed of a central gland with a surrounding epithelial sheath and empty into the periostracal groove. It is likely, based upon the possession of these organs and a wide variety of other morphological similarities offered by Allen & Turner (1974), that Verticordiidae and *Lyonsia* have a close ancestry. It is unlikely that such specialized glands arose separately in two such similar bivalve families. The Verticordiidae may have evolved from a *Lyonsia*-like ancestor. A lineage of this sort, described by Allen & Turner (1974), involves an evolutionary descent from *Lyonsia* to *Policordia* to *Lyonsiella*. In this series the dorsal hood of the stomach is lost, the gastric shield is expanded posteriorly, and the stomach walls are muscularized (Allen & Turner, 1974).

Evolution within the Lyonsiidae has, to some extent, followed a lineage leading to more sedentary habits (Yonge, 1952) starting with a free-living *Lyonsia* ancestor. The fourth pallial aperture, common to all lyonsiids, may be a symplesiomorph of a deep-burrowing ancestor (Ansell, 1967). The fused mantle lobes of lyonsiids in conjunction with the fourth aperture are found together only in Mactridae and Solenidae, both of which possess numerous deep-burrowing members (Pelseneer, 1906). The Lower Carboniferous bivalve, *Wilkingia*, is considered the first deep-burrowing member of the Anomalodesmata (Runnegar, 1974). These elongated bivalves had deep pallial sinuses and may have evolved from genera such as *Cuneamya* and *Pholadella* of the Lower Paleozoic (Runnegar, 1974). According to Runnegar (1974) the Pholadomyidae were well established by the Middle Paleozoic, and Ansell (1967) feels that most recent Anomalodesmata have "secondarily returned to a shallow

burrowing habit." Thus the lineage leading to many extant Anomalodesmata is from deeper burrowers (still retained in the Pholadomyidae) to shallow dwellers, and evolution within the Lyonsiidae is towards more sedentary habits (Yonge, 1952). This dual progression corresponds with the development of the arenophilic glands.

If we visualize some ancestral Anomalodesmata as deep burrowers with long siphons, it seems evident that the role of shell elaborations (i.e., spines, deep ribs, sediment coat, etc.) would not be of the same importance as in near surface dwellers. Deeper in the substratum there is less shifting of sediments and the stabilizing elaborations are not "needed." If we raise the bivalve to a microhabitat closer to the sediment-water interface, the higher energy environment would dictate the "need" for some method of control to maintain the bivalve's stability and protect thin shelled, exposed members from predation. This is seen many times among near surface dwelling bivalves (i.e., *Pitar*, *Pinna*, *Trachycardium*, *Cerastoderma*, etc.) in the production of spines and ribs while deeply burrowing species are often quite smooth-shelled (i.e., *Tellina*, *Ensis*, *Tagelus*, etc.). Members of the Lyonsiidae lack well-developed spines or deep ribs and are fairly smooth shelled except for low, radial striations and small spinules (Prezant, 1979b). Many members of the Verticordiidae also have only very small spines radially ornamenting their shells (Allen & Turner, 1974). Both the lyonsiids and verticordiids are either shallow burrowers or epifaunistic. The mucoid secretions from the arenophilic glands essentially allow the shell to incorporate extraneous particles and thus added surface area. A similar condition exists in *Laternula truncata*. This bivalve produces small prefabricated spinules over its shell to aid in stabilization (Aller, 1974).

The arenophilic radial mantle glands offer a unique tool to help decipher the course of evolution within the Lyonsiidae. Three primary distinctions exist between mantle glands of *Lyonsia* and *Entodesma*: 1) location relative to the periostracal groove, 2) origin of sheath cells, and 3) penetration of the periostracum by the glandular secretion in *Entodesma* (Fig. 1). It is not difficult to envisage the evolutionary development of the two gland types. Mucocytes are common along the mantle edge of most bivalves. Glands in *Lyonsia* are elaborations of the outer mantle fold surrounded by a glandular sheath from the

middle fold. Both the central gland and the sheath in *Entodesma* are elaborations of the outer fold. The latter is evident not only in histological preparations but also by the occurrence of microvilli along the sheath cells. Microvilli commonly occur on the outer mantle epithelium.

The differentially placed arenophilic radial mantle glands in the lyonsiids suggest a major change in the currently accepted intrafamilial lineage. The direct *Lyonsia* to *Entodesma* to *Mytilimeria* lineage predicted by Yonge (1952) is unlikely to have occurred since it is difficult to envisage an evolutionary transition from mantle glands of *Lyonsia* to those of *Entodesma*. For this to have taken place would have necessitated a movement of gland cells through periostracal groove cells to take up a position distal to the groove or, a regression of proximal gland cells in *Lyonsia* and a redevelopment of the gland distal to the periostracum secreting cells. It is more likely that arenophilic glands evolved under similar conditions in both genera from a series of mucocytes surrounding the periostracal groove. Thus, from the ancestral mantle edge, three developments can be postulated: 1) mucocytes proximal to the groove developed as arenophilic glands (as found in *Lyonsia*), 2) mucocytes distal to the groove evolved into arenophilic glands (as found in *Entodesma*), or 3) the mantle edge remained unchanged, as in *Mytilimeria*. Each of these developments, of course, would involve corresponding chemical evolution of appropriate mucoid substances and enzymes. The third development is unlikely on the basis of total morphology and habits of *Mytilimeria*. *Mytilimeria* is probably descended through the *Entodesma* stock since there is a good progression evident in extant species. *Entodesma* are slightly heteromyarian while *Mytilimeria* are heteromyarian; there is an increasing degree of sedentariness in the two genera; many shallow water species of *Entodesma* found in rocky intertidal zones possess a well-developed, granular, homogeneous layer in their shell ultrastructure and *Mytilimeria* retains a thin homogeneous layer (Prezant, 1980a); and there is an increasing body angle in the two genera (Yonge, 1952). Both also possess a muscularized mantle edge, lack photoreceptors in their siphons, have a high concentration of mucocytes adorning their inner mantle margin, have a small cylindrical foot and a small, circular pedal gape with a raised internal rim, and have increasing

diameters in their siphonal lumens, respectively. *Lyonsia* on the other hand, are isomyarian or very slightly heteromyarian; free-living; lack a homogeneous shell layer; have a poorly muscularized mantle edge; have numerous, small photoreceptor organs in a dense band along their exhalent siphon; have a low-lying elongated pedal aperture without a raised internal rim; and have narrow siphonal lumens. At least some species of *Lyonsia* as well as *Mytilimeria* possess a modified type of ring nacre (Prezant, 1980a). These generic distinctions are outlined and discussed in more detail elsewhere (Prezant, 1980a, b).

Based upon these distinctions, I hypothesize that *Lyonsia* and *Entodesma* diverged early in their evolution from a common *Lyonsia*-like ancestor that originally lacked arenophilic glands (Fig. 42). *Mytilimeria* evolved from intertidal *Entodesma* stock, perhaps already associated with (nestled among) compound ascidians, and secondarily lost arenophilic mantle glands sometime after assuming a sessile life-style within compound ascidians. In this microhabitat, the endosymbionts developed a physically adhesive periostracum (Prezant, 1980a) and gradually lost, not only the arenophilic glands, but an active byssal attachment and thick shell. Ring nacre, presently known only from thin shelled genera of lyonsiids, is probably a primitive trait that has been lost in the thicker shelled members of *Entodesma* and most species of *Lyonsia*.

Following the development of a thick,

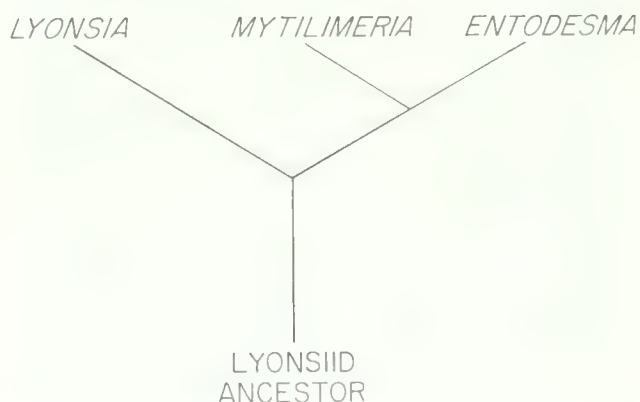

FIG. 42. Hypothetical phylogenetic tree of lyonsiid evolution. The initial divergence signifies the split in arenophilic gland formation (a parallel event producing similar apomorphs). The secondary divergence (resulting in *Mytilimeria* and *Entodesma*) signifies dichotomies in retention or loss of arenophilic glands, and morphological distinctions previously outlined.

strong shell and byssus, and movement into stable quarters (i.e., nestling habits) where shells may be molded to conform with the outline of their shelters, some species of *Entodesma* may gradually lose their arenophilic glands. The strong shell and anchorage obviate the "need" for a protective or stabilizing extraneous coat. The same reasoning is applied to *Mytilimeria nuttalli* where the host ascidian insures protection and stabilization, roles previously assumed by an extraneous sand coat still typical of the thin-shelled, more exposed *Lyonsia*. The unique intergeneric adaptations of the shell (Prezant, 1980a) and the mantle edge in lyonsiid bivalves reflects their diverse accommodations to a wide array of microhabitats, as well as their phylogenetic plasticity. These same adaptations have undoubtedly insured the survival of this intriguing molluscan group.

#### ACKNOWLEDGMENTS

I gratefully acknowledge the generous donations and loans of specimens that made this work possible. Thanks to: Dr. J. A. Allen, University Marine Biological Station, Millport, Isle of Cumbrae, Scotland; Dr. F. Bernard, Pacific Biological Station, Nanaimo, British Columbia; Dr. K. Boss, Museum of Comparative Zoology, Harvard University, Cambridge, Massachusetts; Drs. D. D. Chivers and W. Lee, California Academy of Sciences, San Francisco, California; Dr. G. M. Davis, Academy of Natural Sciences of Philadelphia, Philadelphia, Pennsylvania; R. Dillon, University of Pennsylvania, Philadelphia, Pennsylvania; R. Fay, Pacific Bio-Marine Labs., Venice, California; Dr. R. Fernald, Friday Harbor Laboratories, University of Washington, Friday Harbor, Washington; C. Gallardo, Instituto de Zoología, Universidad Austral de Chile, Valdivia, Chile; Dr. J. H. McLean, Los Angeles County Museum of Natural History, Los Angeles, California; Dr. J. Rosewater, National Museum of Natural History, Smithsonian Institution, Washington, D.C.; and Dr. R. Virnstein, Harbor Branch Foundation, Inc., Fort Pierce, Florida. I am also most grateful for the continuous aid and direction given by Dr. M. R. Carriker during this study and valuable discussions with Dr. G. Davis. Thanks are also extended to Dr. N. W. Riser for help in some of the histological interpretations. Drs. R. T. Abbott, M. R. Carriker, F. C. Daiber, R. E. Hillman and N. W. Riser kindly reviewed the manuscript and

offered many helpful suggestions. The collaborative support given by my family is greatly appreciated. Thanks also to P. Savage for typing the manuscript and P. Palinski for help with some of the micrographs.

#### LITERATURE CITED

- ALLEN, J. A., 1958, Observations on *Cochlodesma praetenu* (Pulteney) (Eulamellibranchia). *Journal of the Marine Biological Association of the United Kingdom*, 37: 97-112.
- ALLEN, J. A. & TURNER, J. F., 1974, On the functional morphology of the family Verticordiidae (Bivalvia) with descriptions of new species from the abyssal Atlantic. *Philosophical Transactions of the Royal Society of London*, ser. B, 268: 401-536.
- ALLER, R. C., 1974, Prefabrication of shell ornamentation in the bivalve *Laternula. Lethaia*, 7: 43-56.
- ANSELL, A. D., 1967, Burrowing in *Lyonsia norvegica* (Gmelin) (Bivalvia: Lyonsiidae). *Proceedings of the Malacological Society of London*, 37: 387-393.
- BARKA, T. & ANDERSON, P. J., 1965, *Histochemistry: Theory, practice and bibliography*. Harper and Row, New York, 660 p.
- BERNARD, F. R. & BAGSHAW, J. W., 1969, Histology and fine structure of the accessory boring organ of *Polinices lewisi* (Gastropoda, Prosobranchiata). *Journal of the Fisheries Research Board of Canada*, 26: 1451-1457.
- BEVELANDER, G. & NAKAHARA, H., 1970, An electron microscope study of the formation and structure of the periostracum of a gastropod, *Littorina littorea*. *Calcified Tissue Research*, 5: 1-12.
- CARRIKER, M. R., 1969, Excavation of boreholes by the gastropod *Urosalpinx*: an analysis by light and scanning electron microscopy. *American Zoologist*, 9: 917-933.
- CARRIKER, M. R., 1972, Observations on removal of spines by Muricid gastropods during shell growth. *Veliger*, 15: 69-74.
- CARRIKER, M. R., 1978, Ultrastructural analysis of dissolution of shell of the bivalve *Mytilus edulis* by the accessory boring organ of the gastropod *Urosalpinx cinerea*. *Marine Biology*, 48: 105-134.
- CARRIKER, M. R., WILLIAMS, L. G. & VAN ZANDT, D., 1978, Preliminary characterization of the secretion of the accessory boring organ of the shell-penetrating muricid gastropod *Urosalpinx cinerea*. *Malacologia*, 17: 125-142.
- CARRIKER, M. R. & WILLIAMS, L. G., 1978, The chemical mechanism of shell dissolution by predatory boring gastropods: A review and a hypothesis. *Malacologia*, 17: 143-156.
- CLENCH, W. J., 1942, A remarkable development of pseudosculpture on a bivalve. *Nautilus*, 55: 73-74.
- DAKIN, W. J., 1928, The eyes of *Pecten*, *Spondy-*

- lus, *Amusium* and allied lamellibranchs with a short discussion of their evolution. *Proceedings of the Royal Society of London*, ser. B, 103: 355–365.
- FRETTER, V. & GRAHAM, A., 1954, Observations on the opisthobranch mollusc *Acteon tornatilis* (L.). *Journal of the Marine Biological Association of the United Kingdom*, 33: 565–583.
- GILMOUR, T. H. J., 1967, The defensive adaptations of *Lima hians*. *Journal of the Marine Biological Association of the United Kingdom*, 47: 209–221.
- HILLMAN, R. E., 1964, The functional morphology of the fourth fold of the mantle of the northern quahog, *Mercenaria mercenaria*. *Journal of the Elisha Mitchell Scientific Society*, 80: 8–12.
- HILLMAN, R. E., 1968, Histochemistry of mucosubstances in the mantle of the clam *Mercenaria mercenaria*. I. A glycosaminoglycan in the first marginal fold. *Transactions of the American Microscopical Society*, 88: 420–425.
- HILLMAN, R. E., 1969, Histochemistry of mucosubstances in the mantle of the clam *Mercenaria mercenaria*. II. Mucosubstances in the second marginal fold. *Transactions of the American Microscopical Society*, 88: 420–425.
- HILLMAN, R. E. & SHUSTER, C. N., Jr., 1960, Observations on the mantle of the northern quahog *Mercenaria mercenaria*. *Proceedings of the National Shellfisheries Association*, 51: 15–22.
- HILLMAN, R. E. & SHUSTER, C. N., Jr., 1966, A comment on the origin of the fourth fold in the mantle of the quahog *Mercenaria mercenaria*. *Chesapeake Science*, 7: 112–113.
- HODGKIN, N. M., 1962, Limestone boring by the mytilid *Lithophaga*. *Veliger*, 4: 123–129.
- HUMASON, G. L., 1972, *Animal Tissue Techniques*. Freeman, San Francisco, ed. 3, 641 p.
- HYMAN, L., 1967, *The Invertebrates*, Vol. VI. *Mollusca I*. McGraw-Hill, New York, 602 p.
- MORTON, J. B., 1958, The adaptations and relationships of the Xenophoridae (Mesogastropoda). *Proceedings of the Malacological Society of London*, 33: 89–100.
- MUSCATINE, L., 1967, Glycerol excretion by symbiotic algae from corals and *Tridacna* and its control by the host. *Science*, 156: 516–519.
- NYLEN, M. U., PROVENZA, V., & CARRIKER, M. R., 1969, Fine structure of the accessory boring organ of the gastropod, *Urosalpinx*. *American Zoologist*, 9: 935–965.
- PEARSE, A. G. E., 1968, *Histochemistry, Theoretical and Applied*. Ed. 3, Vol. 1. Williams and Wilkins, Baltimore, Maryland, 759 p.
- PELSENEER, P., 1906, Part 5, Mollusca. In LANKESTER, E. R. (ed.), *A Treatise on Zoology*.
- PETERSON, M. & LEBLOND, C. P., 1964, Synthesis of complex carbohydrates in the Golgi region as shown by radioautography after injection of labeled glucose. *Journal of Cell Biology*, 21: 143–154.
- PREZANT, R. S., 1979a, The structure and function of the radial mantle glands of *Lyonsia hyalina* (Bivalvia: Anomalodesmata). *Journal of Zoology* 187: 505–516.
- PREZANT, R. S., 1979b, Shell spinules of the bivalve *Lyonsia hyalina*. *Nautilus*, 93: 93–95.
- PREZANT, R. S., 1980a, Comparative shell ultrastructure of lyonsiid bivalves. *Veliger*.
- PREZANT, R. S., 1980b, Taxonomic re-evaluation of the bivalve family Lyonsiidae. *Nautilus*.
- RONKIN, R. R., 1952, Cytological studies on mucus formation and secretion in *Busycon*. *Biological Bulletin*, 102: 252–260.
- RONKIN, R. R. & RONKIN, E., 1951, Cytochemical studies on mucous epithelial cells. *Biological Bulletin*, 101: 228.
- RUNNEGAR, B., 1974, Evolutionary history of the bivalve subclass Anomalodesmata. *Journal of Paleontology*, 48: 904–939.
- SCOTT, J. E., DORING, J. & QUINTARELLI, G., 1964, Differential staining of acid glycosaminoglycans by alcian blue in salt solutions. *Biochemical Journal*, 90: 4–5.
- STASEK, C. R. & MCWILLIAMS, W. R., 1973, The comparative morphology and evolution of the molluscan mantle edge. *Veliger*, 16: 1–19.
- STORCH, V. & WELSCH, U., 1972, The ultrastructure of epidermal mucus cells in marine invertebrates (Nemertini, Polychaeta, Prosobranchia, Opisthobranchia). *Marine Biology*, 13: 167–175.
- THOMPSON, S. W., 1966, *Selected Histochemical and Histopathological Methods*. Thomas, Springfield, Illinois, 1639 p.
- THOMPSON, T. E., 1960, Defensive acid-secretion in marine gastropods. *Journal of the Marine Biological Association of the United Kingdom*, 39: 115–122.
- WAITE, J. H. & WILBUR, K. M., 1976, Phenol oxidase in the periostracum of the marine bivalve *Modiolus demissus*. *Journal of Experimental Zoology*, 195: 359–367.
- WELSCH, U. & STORCH, V., 1976, Comparative animal cytology and histology. University of Washington Press, 343 p.
- WIGGLESWORTH, V. B., 1972, *The Principles of Insect Physiology*. Ed. 7. Chapman and Hall, London, 827 p.
- YONGE, C. M., 1952, Structure and adaptation in *Entodesma saxicola* (Baird) and *Mytilimeria nuttalli* Conrad, with a discussion on evolution within the family Lyonsiidae (Eulamellibranchia). *University of California Publications in Zoology*, 55: 439–450.
- YONGE, C. M. & MORTON, B., 1979, Ligament and lithodesma in the Pandoracea and the Poromyacea with a discussion on evolutionary history in the Anomalodesmata (Mollusca: Bivalvia). *Journal of Zoology*, 191: 263–292.
- YONGE, C. M. & THOMPSON, T. E., 1976, *Living marine molluscs*. William Collins, Glasgow, 288 p.
- ZOTTOLI, R. A. & CARRIKER, M. R., 1974, Burrow morphology, tube formation, and microarchitecture of shell dissolution by the spionid polychaete *Polydora websteri*. *Marine Biology*, 27: 307–316.



RHODOPETALINAE, A NEW SUBFAMILY OF ACMAEIDAE FROM THE  
BOREAL PACIFIC: ANATOMY AND SYSTEMATICS

David R. Lindberg

Center for Coastal Marine Studies, University of California,  
Santa Cruz, California 95064, U.S.A.

and

Department of Invertebrate Zoology, California Academy of Sciences,  
San Francisco, California 94118, U.S.A.

ABSTRACT

Doubt concerning the familial assignment of the patellacean limpet *Rhodopetala rosea* (Dall, 1872) has existed since the species was described. The shell morphology and structure are patellid features, while the radular teeth configuration is distinctly acmaeid. The anatomy of *R. rosea* is basically acmaeid, but there are several significant differences and patellid features. The gill is located in the nuchal cavity and is rudimentary. Its structure is analogous to the individual lappets that form the secondary gill found in the mantle groove of patellid limpets and some acmaeids. The gill lacks filaments, a septum, distinct ciliated bands, and skeletal support and arises from the mantle skirt rather than the posterior wall of the nuchal cavity. Correspondingly, the vessels of the auricle are modified to receive blood from the haemocoelic spaces in the nuchal cavity roof. In addition, the circumpallial vessel connects with the haemocoelic spaces rather than directly with the auricle. The anterior portions of the right and left excretory organs extend above the nuchal cavity within the mantle skirt. Structures of the digestive system—looping of the alimentary tract and radular sac, radular dentition—are acmaeid features, while the position of the gonad is like that seen in patellid limpets. Modifications of the respiratory and circulatory systems may be adaptations associated with the brooding behavior of the species. The unique shell structure of this acmaeid limpet and the anatomical characters warrant a new subfamilial category within the family Acmaeidae.

Rhodopetalinae subfam. nov. is distinguished from other acmaeid subfamilies by a helcioniform rather than conical shell, an interior central area with a silvery metallic lustre rather than a porcelaneous central area, and the presence of a rudimentary gill without typical ctenidial structures. The combination of the patellid shell structure and acmaeid-like anatomy suggest that the Rhodopetalinae is an ancestral intermediate group between the acmaeid and cellanid limpets.

INTRODUCTION

The superfamily Patellacea Rafinesque, 1815 includes three Recent families: Acmaeidae Forbes, 1850; Lepetidae Dall, 1869, and Patellidae Rafinesque, 1815 (Knight et al., 1960). Members of these subfamilies have a docoglossate radula, subcentral to anterior shell apex, and a horseshoe-shaped myostracum (muscle scar). Families are distinguished by anatomical criteria. Acmaeid limpets are the only patellaceans with a ctenidium, in addition, some species also have a secondary gill (branchial cordon). In the Lepetidae gills are completely lacking, respiratory exchange taking place in the lining of the mantle groove (Powell, 1973). In members of the Patellidae only a secondary gill is present. Radular teeth configurations can also be used to distinguish families, however,

dentition is more useful for distinguishing genera within families.

MacClintock (1967) introduced a new character into patellacean systematics: shell structure. MacClintock found 17 different types of crystal structure and layering in Recent and fossil patellacean shells, 10 in the Patellidae, 8 in the Acmaeidae, and 1 in the Lepetidae. Thus, the gill, radular, and shell structure characters of each of the 3 families, taken in aggregate, clearly delineate and define them, despite some shared characters such as secondary gills and shell structure (Table 1).

While preparing a revision of the Acmaeidae I took under study the familial assignment of the small boreal patellacean, *Rhodopetala rosea* (Dall, 1872). Doubt concerning the familial assignment of this species has existed since the species was described. In the original description *R. rosea* was questionably as-

TABLE 1. Characters of Recent Patellacean Limpets

Taxon	Shell structure group no. <sup>1</sup>	Radula (M-L-R-L-M) <sup>2</sup>	Gill
Family Patellidae			
Genus <i>Patella</i>	6, 8	3-3-0-3-3	complete secondary gill
	6, 8, 9, 10	3-3-1-3-3	complete secondary gill
Genus <i>Helcion</i>	6, 7	3-3-0-3-3	incomplete secondary gill
	6	3-3-1-3-3	incomplete secondary gill
Genus <i>Cellana</i>	12, 13, 14	3-2-0-2-3	incomplete secondary gill
Genus <i>Nacella</i>	11	3-2-0-2-3	complete secondary gill
Family Acmaeidae			
Genus <i>Acmaea</i>	15	0-3-0-3-0	ctenidium
Genus <i>Pectinodonta</i>	15	0-3-0-3-0 <sup>3</sup>	ctenidium
Genus <i>Tectura</i>	1	0-3-0-3-0 <sup>4</sup>	ctenidium
Genus <i>Rhodopetala</i>	12	0-3-0-3-0	rudimentary gill
Genus <i>Notoacmea</i>	1, 4, 5	0-3-0-3-0 <sup>5</sup>	ctenidium
Genus <i>Problacmaea</i>	2	0-3-0-3-0	ctenidium
Genus <i>Collisella</i>	1, 16	1-3-0-3-1	ctenidium
Genus <i>Lottia</i>	1	1-3-0-3-1	ctenidium & secondary gill
Genus <i>Scurria</i>	3	1-3-0-3-1	ctenidium & secondary gill
Genus <i>Patelloida</i>	2	2-3-0-3-2	ctenidium
Family Lepetidae			
Genus <i>Lepeta</i>	15	2-2-0-2-2	absent
Genus <i>Cryptobranchia</i>	15	2-2-0-2-2	absent

<sup>1</sup>After MacClintock (1967).

<sup>2</sup>M = # of marginal teeth, L = # of lateral teeth, R = # of rachidian teeth.

<sup>3</sup>Multicuspid lateral teeth.

<sup>4</sup>Basal plates simple.

<sup>5</sup>Basal plates complex.

MacClintock's (1967) shell structure group no. 17 restricted to Eocene patellaceans.

signed to the genus *Nacella* Schumacher, 1817 in the family Patellidae. This familial assignment was followed by Pilsbry (1891), who placed the species in the genus *Patella*, subgenus *Helcion* Montfort, 1890 because of the submarginal apex. Dall (1921) changed his original familial assignment and established *Rhodopetala*, by monotypy and without explanation, as a section of the Acmaeidae. Oldroyd (1927), Keen (1937), and Burch (1946) all followed Dall and considered *R. rosea* to be an acmaeid.

Keen (1960) transferred *Rhodopetala* back to the family Patellidae, placing it as a subgenus of *Helcion*. McLean (1966) also considered *R. rosea* to be a patellid, and treated it as a subgenus of *Ansates* Sowerby, 1839, regarded by Keen (1960) and McLean (1966) as the prior name for *Patina* Gray, 1847. MacClintock (1967), after studying the shell structure, assigned *Rhodopetala* as a subgenus of the patellid genus *Cellana* H. Adams, 1869.

All of these workers utilized characters found in the shell because whole animals

were unknown. Golikov & Kussakin (1972) published on the first known whole specimens of *R. rosea*, indicating its ovoviviparity and the distinct acmaeid configuration of the radular teeth. They placed it in the family Tecturidae Gray, 1847 [= Acmaeidae]. Powell (1973), in a monograph of the Patellidae and Christiaens (1976), in a revision of the Acmaeidae, have also considered *R. rosea* to be an acmaeid. However, there has remained the paradox of the shell structure being patellid (MacClintock, 1967) and the radula being acmaeid (Golikov & Kussakin, 1972). The absence of specialized respiratory structures (Golikov, personal communication, 1978), a lepetid character, further obscures the familial position of these limpets.

In the present paper aspects of the anatomy of *R. rosea* are described and illustrated for the first time. The findings of this study have caused me to reconsider my earlier familial assignment (Lindberg, 1977) and I now consider *R. rosea* to belong to the family Acmaeidae. Because much of the anatomy of *R. rosea* differs so little from previously stud-



ied acmaeids, only specific characters, significant anatomical differences, and diagnostic familial characters are presented and discussed. However, several of the anatomical differences are significant enough to warrant subfamilial rank and I therefore propose a new subfamily within the Acmaeidae.

#### MATERIALS AND METHODS

Specimens of *R. rosea* were collected by C. E. O'Clair from intertidal areas on Amchitka Island, Aleutian Islands, Alaska in 1971, 1972, and 1974 (Table 2). The limpets were fixed in 10% formalin and then placed in 70% isopropyl alcohol. A single specimen was dehydrated, cleared, and embedded in paraffin. Serial, transverse sections were cut on a microtome at 10  $\mu\text{m}$  and stained with haematoxylin and eosin.

The organ systems were reconstructed from the sections by mapping the dimensions and positions of structures at intervals of 50  $\mu\text{m}$  or less. Four additional specimens were dissected to corroborate the reconstructions. The tissue sections and radula preparations are deposited in the Natural History Museum of Los Angeles County.

Unless otherwise stated, organs and structures are illustrated as viewed in the dorsal aspect with the anterior towards the top of the page.

#### ANATOMY

##### Shell

The shell (Fig. 1) is small (less than 10 mm long), and of medium height; the apex overhangs the anterior margin. The anterior slope is concave and the posterior and lateral slopes convex. The aperture is ovoid and the sides subparallel. Exterior sculpture consists of concentric growth lines and obsolete radial ribs. Shell color ranges from pink to red, but the apex typically is eroded to white. The interior margin of the shell also ranges from pink to red. The intermediate area is red, but changes to white in wet preserved specimens. The myostracum is horseshoe-shaped and opens broadly anteriorly. A fine pallial line connects the anterior portions of the myostracum. The central area, in both dry and wet preserved specimens, is silvery white.

*Rhodopetala rosea* belongs to MacClintock's (1967) shell structure group no. 12 (Fig. 2). The exterior of the shell and interior margin

TABLE 2. Material examined.

Specimen no.	Size (mm)	Sex	Depository	Remarks
1	3.6	♂	1	sectioned
2	4.8	♀	1	
3	5.5	ind.	1	dissected
4	7.6	♀	1	dissected
5	8.5	♂	1	dissected
6	4.7	♀	2	
7	4.8	♀	2	
8	5.4	ind.	2	
9	5.8	♂	2	
10	7.3	♂	2	
11	8.6	♀	2	dissected

ind. = indeterminate; 1 = Natural History Museum of Los Angeles County #71-252; 2 = National Museum of Natural Science, Ottawa #1976-30.



FIG. 1. *Rhodopetala rosea* (Dall, 1872) (Natural History Museum of Los Angeles County #71-252).

consist of a complex prismatic layer. Two layers are present in the intermediate area. Nearest to the interior margin the shell structure is foliated. This is followed by a radial crossed-lamellar layer that extends to the myostracum. Interior of the myostracum the central area is composed of a complex crossed-lamellar layer. Altogether there are 5 layers including the myostracum.

##### External anatomy

Removed from the shell and viewed in the ventral aspect (Fig. 3), the foot is small and subcircular, covering approximately 60% of

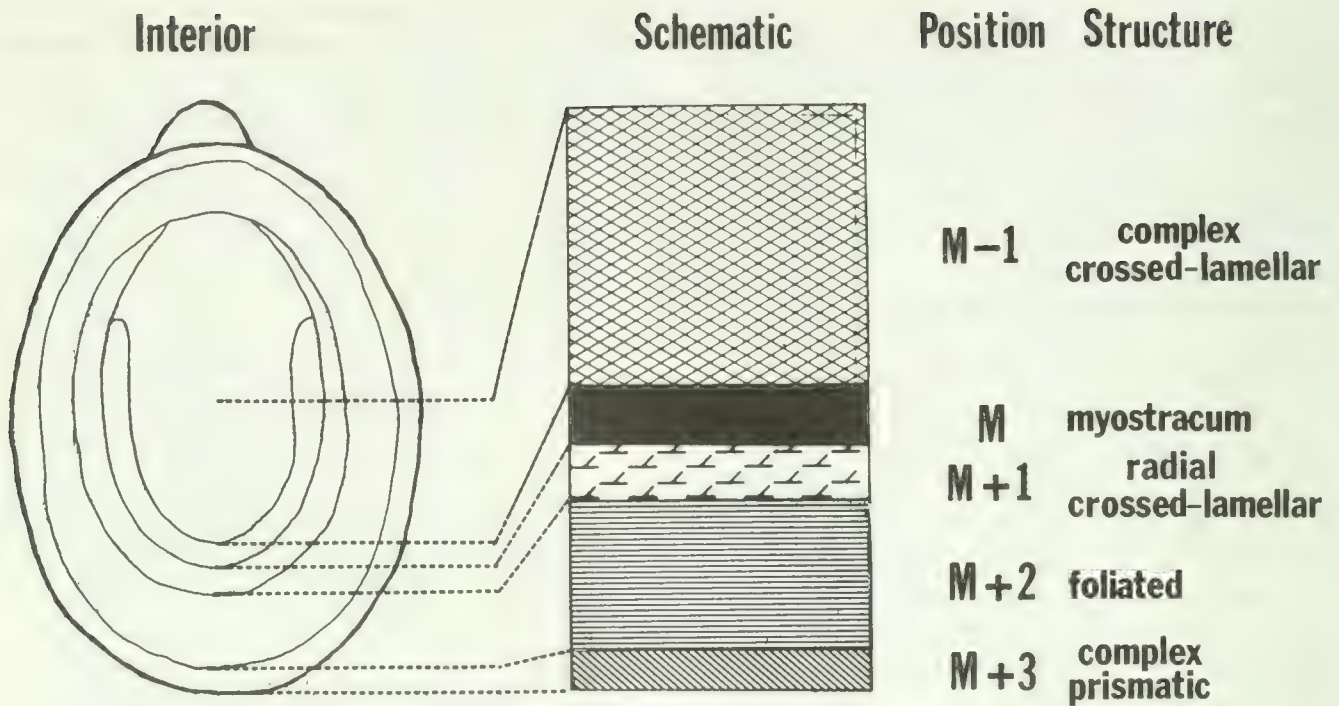

FIG. 2. Shell structure of *Rhodopetala rosea*.

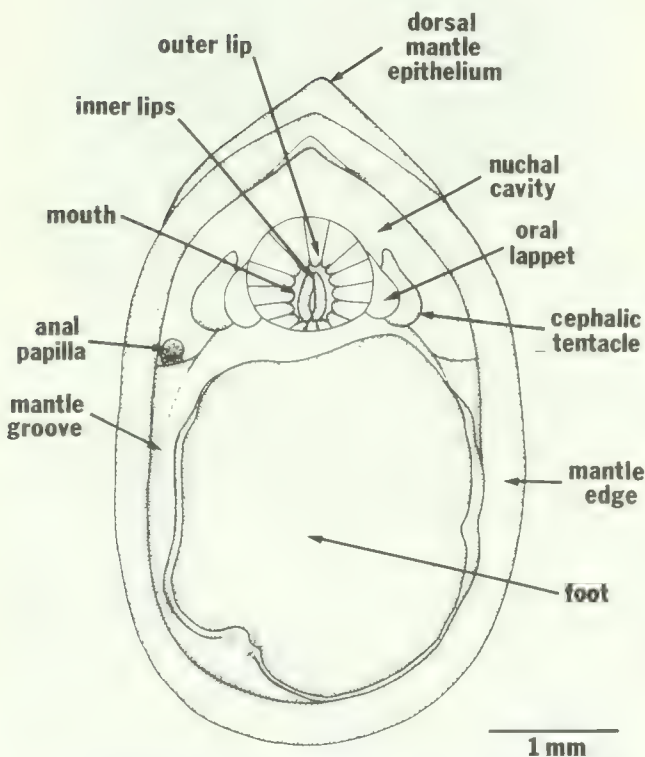

FIG. 3. Ventral view of *Rhodopetala rosea* removed from shell.

the aperture posteriorly. The head is oval with a single pair of cephalic tentacles arising dorsolaterally. The mouth appears as a sagittal slit and is surrounded by a broad outer lip. Laterally the outer lip is drawn out into large oral lappets. The anal papilla is visible below the right cephalic tentacle. The mantle margin is thickened around the perimeter of the aperture, especially along the anterior

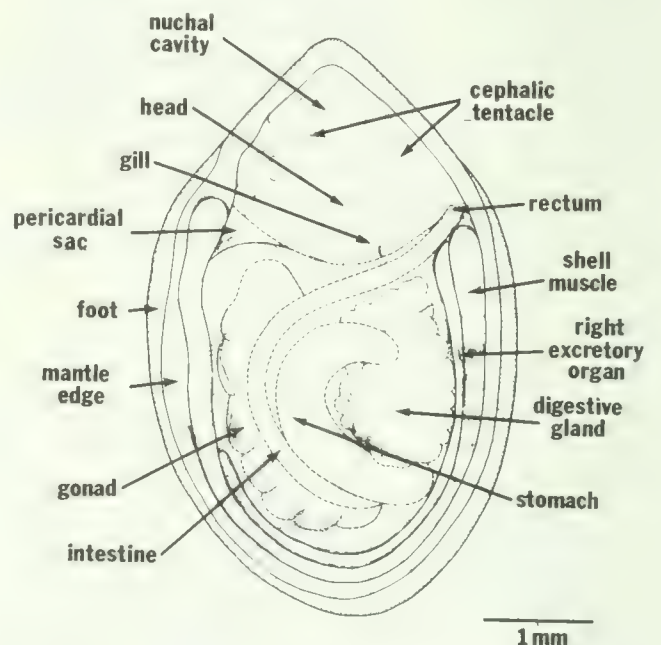

FIG. 4. Dorsal view of *Rhodopetala rosea* removed from shell.

portion of the nuchal cavity. No pallial tentacles are visible.

Viewed in the dorsal aspect (Fig. 4), the large nuchal cavity is visible at the anterior of the limpet. A small flap of tissue, the gill, is visible through the mantle in the middle of the nuchal cavity. To the left of the gill is the pericardial sac. The visceral mass is surrounded laterally and posteriorly by the shell muscle. This horseshoe-shaped muscle is made up of nondiscrete muscle bundles and opens broadly anteriorly. In the center of the visceral

mass is the kidney-shaped stomach. A lobate digestive gland is to the right of the stomach. Between the digestive gland and the shell muscle, the dorsal surface of the right excretory organ can be seen. The gonad lies to the left of the stomach and against the left shell muscle. The intestine, arising from under the posterior end of the stomach, curves around the left side of the stomach and extends diagonally across the viscera, terminating at the anal papilla, which is adjacent to the right of the gill and anterior of the shell muscle.

#### Internal anatomy

**Nuchal cavity**—The nuchal cavity is large and is 40% of the animal's total length. The anterior end of the cavity is narrowed, conforming to the submarginal apex, and the thickened mantle margin. Between the dorsal and ventral mantle epithelia is a large, continuous haemocoelic space crossed by numerous tissue strands (Fig. 5a). The ciliated posterior portion of the roof of the nuchal cavity has large concentrations of cilia on the left side. A corresponding concentration of cilia occurs on the left side of the head immediately below this region.

The single gill lies in the midline of the nuchal cavity. The gill arises from the ventral mantle epithelium, not from the posterior wall of the nuchal cavity (Fig. 6). To the right, at the base of the gill lie the left excretory organ, rectum, and right excretory organ. The anterior portions of the excretory organs extend anteriorly into the mantle skirt, and the excretory pores open ventrally. The anal papilla is elongated and directed ventrally so that it

opens into the mantle groove directly in front of the shell muscle (Fig. 3). The osphradia are situated on the nape of the neck far back in the cavity. The left osphradium is larger than the right. A hypobranchial gland is not present.

**Gill**—The single gill (Figs. 6, 7) arises in the posterior portion of the nuchal cavity from the ventral mantle epithelium at the midline of the limpet's body. It is flat and triangular with the left side slightly longer giving the apex a hooked appearance. The gill is small, 0.62 mm wide at the base and 0.68 mm long in a specimen 7.6 mm long. The gill lacks filaments, a laterally compressed axis (septum), distinct ciliated bands, and skeletal support. It closely resembles the individual lappets that form the secondary gills found in patellid limpets and some acmaeids. Along the edge of the gill runs a marginal vessel that connects on the right side to the haemocoelic space of the roof of the nuchal cavity and on the left side to the auricle of the heart. A haemocoelic space in the central portion of the gill opens on both sides into the marginal vessel. The outer surface of the gill is folded and ciliated, with longer cilia on its ventral surface.

**Digestive system**—The looping of the alimentary tract is simple (Fig. 8). The esophagus lies largely to the left and rotates counter-clockwise approximately 135 degrees based on the position of the dorsal folds. The posterior portion of the esophagus is slightly expanded. Directly behind the dilation it turns to the left and anteriorly broadens into a large stomach. The anterior end of the stomach turns to the right and downward. A constriction marks the beginning of the intestine, which

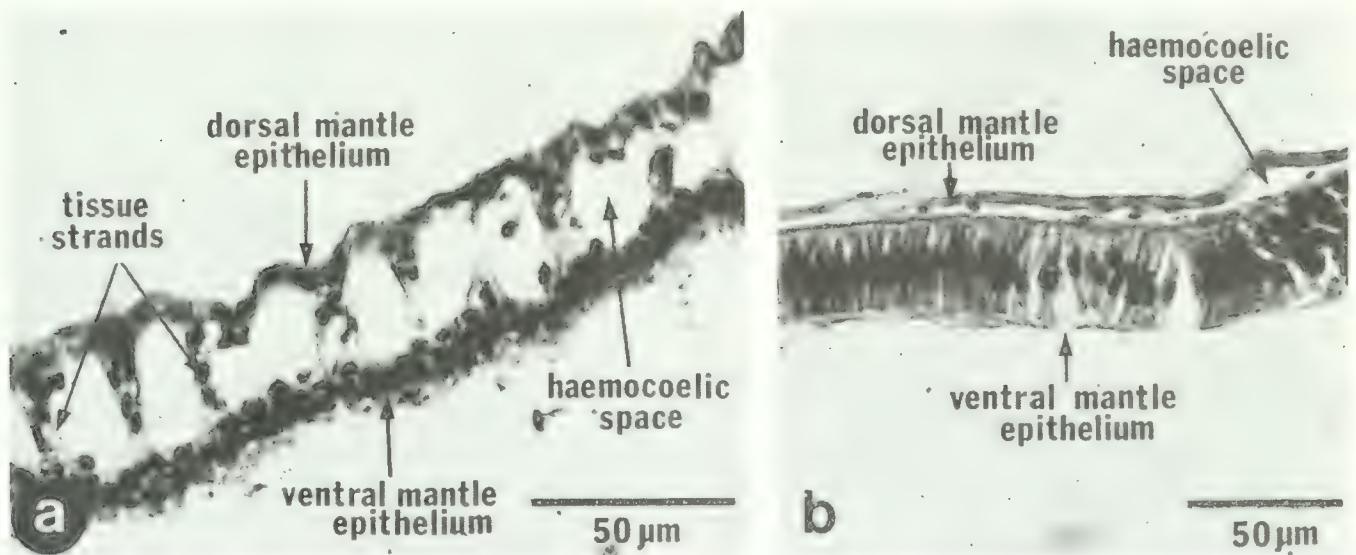

FIG. 5. Transverse section through the mantle skirt. (a) *Rhodopetala rosea*, (b) *Tectura rubella*.

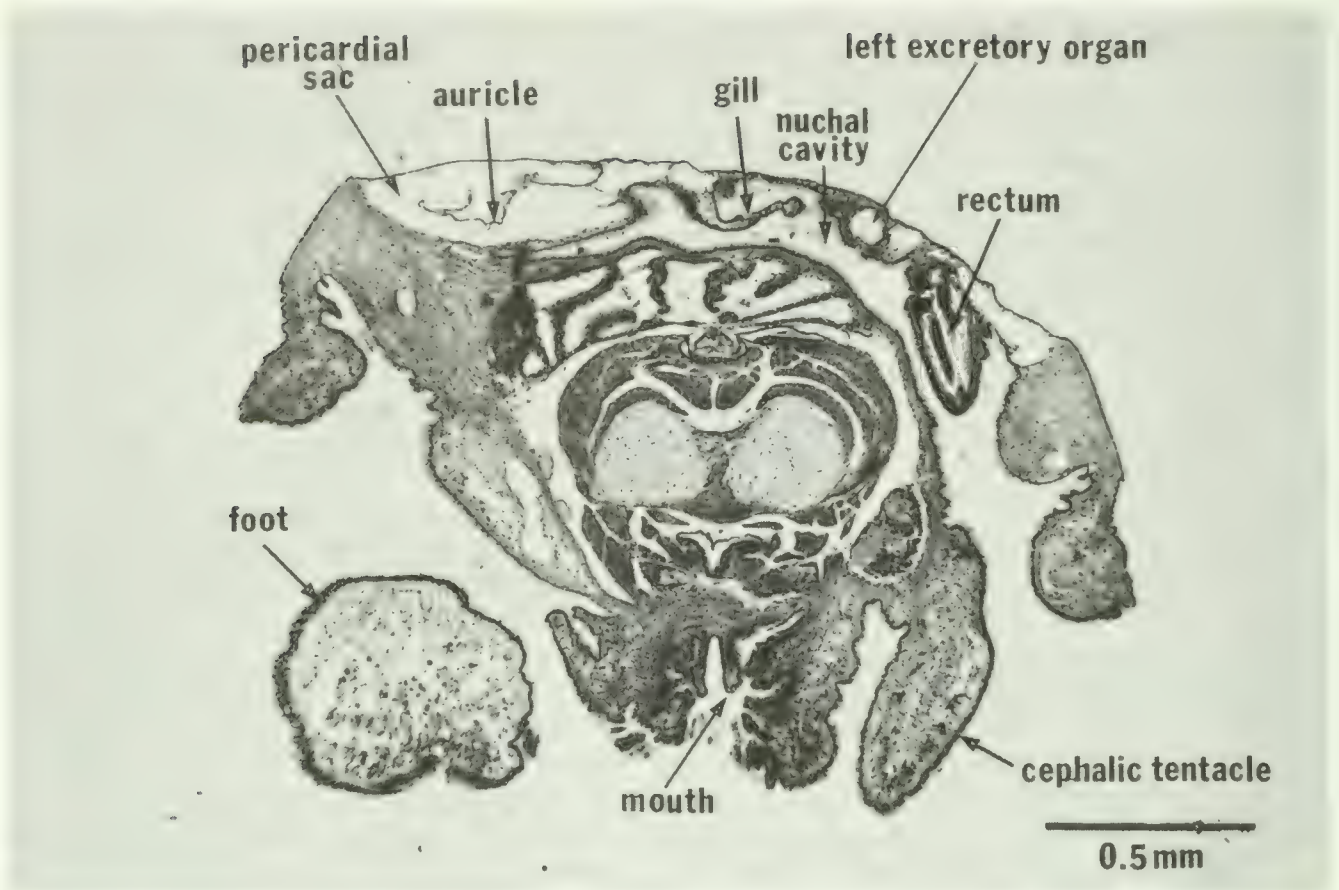

FIG. 6. Transverse section through the head and nuchal cavity of *Rhodopetala rosea*.

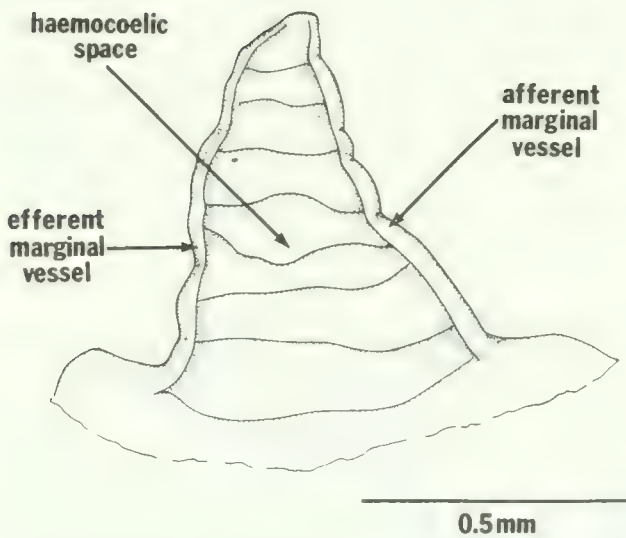

FIG. 7. Gill of *Rhodopetala rosea*.

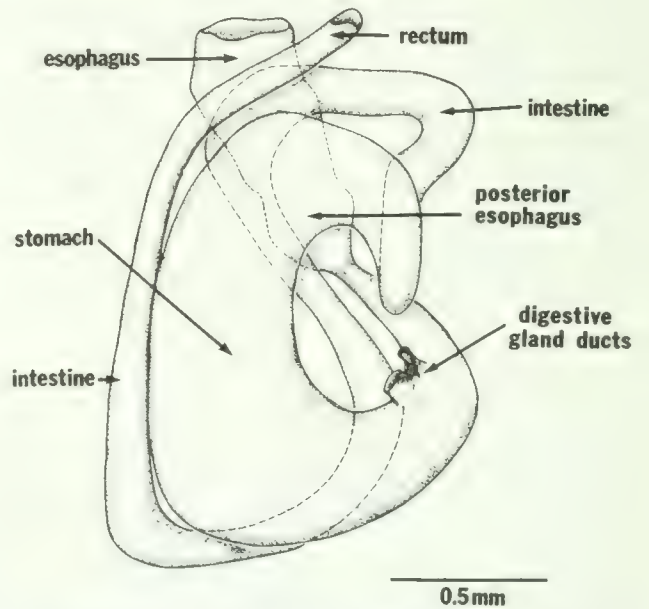

FIG. 8. Alimentary tract of *Rhodopetala rosea*.

proceeds anteriorly for a short distance and then turns to the left and upward. It passes over the esophagus and then turns posteriorly again alongside the posterior portion of the esophagus. Crossing again under the stomach in a broad loop to the left, the intestine turns anterodorsally along the left side of the stomach and finally diagonally crosses the

visceral mass towards the right posterior portion of the nuchal cavity, terminating in the rectum and anal papilla. The intestine has only two loops, the first counterclockwise in the anterior portion of the visceral mass, and the second clockwise in the posterior portion of the visceral mass.

The looping of the radula is mostly in an

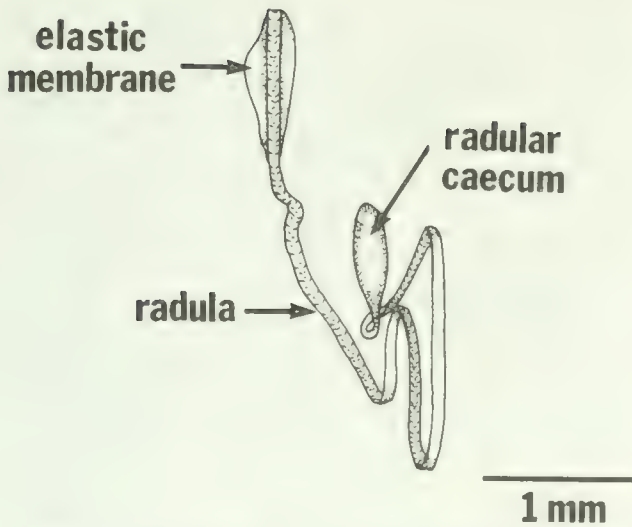

FIG. 9. Radular sac of *Rhodopetala rosea*.

oblique sagittal plane between the folds of the digestive gland (Fig. 9). Behind the head the radular sac extends diagonally along the right side of the esophagus. Immediately posterior to the cross nerve between the right and left pedal nerve cords the radula makes a U-shaped turn upward and runs anteriorly for a short distance. It then makes another U-shaped turn and proceeds posteriorly. After a third upward U-shaped turn the radula extends anteriorly again. In the vicinity of the anterior constriction of the stomach it turns downward proceeding almost to the dorsal surface of the foot where it forms a tight loop and proceeds anteriorly terminating in the radular caecum.

The radula has approximately 40 rows of mature lateral teeth and 20 rows with immature teeth. Each row bears three pairs of lateral teeth (Fig. 10a). The first pair of lateral teeth is closely set at the anterior edge of the

ribbon. The medial and lateral edges of the first lateral teeth are convex. The second pair of lateral teeth are posterior and slightly lateral to the first pair; the medial edges are convex and the lateral edges concave. The third pair of lateral teeth are slightly posterior and lateral to the second pair; the medial edges are convex and the lateral edges are straight. Marginal teeth are lacking.

Radular rows consist of two ventral plates each with three lateral tooth plates (Fig. 10b). The first lateral plates are large and kidney-shaped. They extend beyond the anterior edges of the ventral plates. The second lateral plates are posterior to the first lateral plates and have straight posterior edges. The second lateral plates are separated from the third lateral plates by partial sutures. The lobate third lateral plates have lobes that extend to the margins of the ventral plates. The ventral plates are rectangular with an anterior process and posterior notch. The anterior process is rectangular and the medial edges of the processes continue under the first lateral plates forming a strong anterior suture.

The jaw of *R. rosea* (Fig. 11) is thickened medially and there are two rounded lateral extensions. The lateral edges of the extensions and the dorsal regions immediately adjacent to the medial area also are thickened.

**Circulatory system**—The pericardial sac lies to the left of the visceral mass against the shell muscle and behind the nuchal cavity (Figs. 4, 6). It contains a thin-walled auricle and a muscular ventricle and aortic bulb (Fig. 12). Both auricle and ventricle are attached to the right side of the pericardial sac.

Blood enters the auricle from the haemocoelic space in the roof of the nuchal cavity

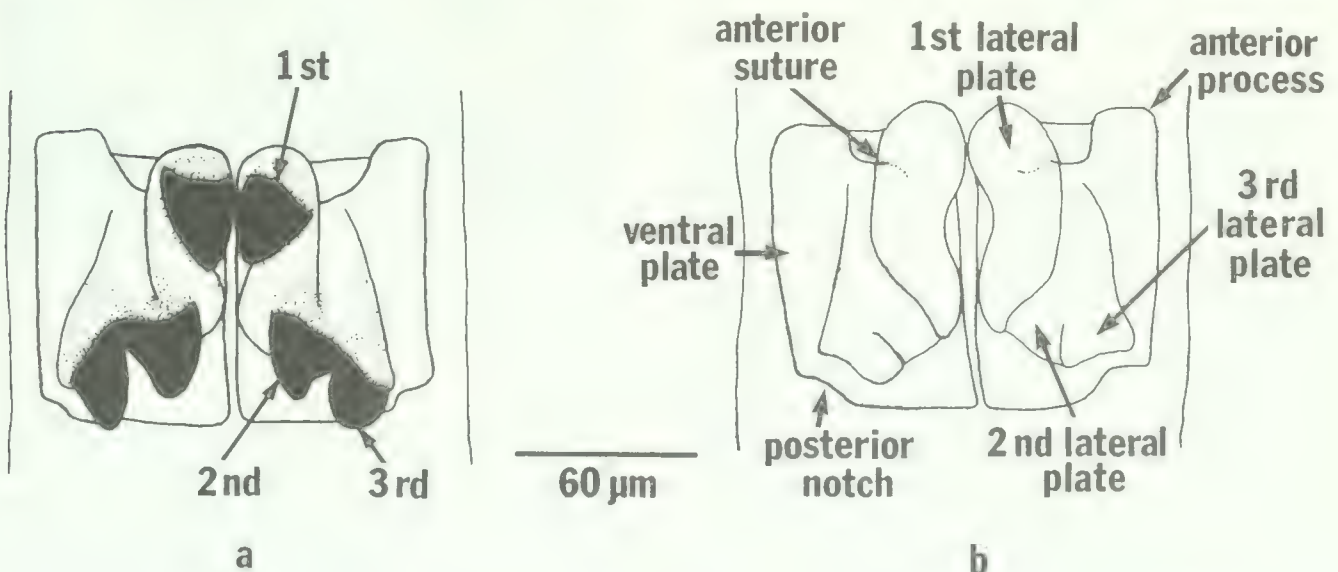
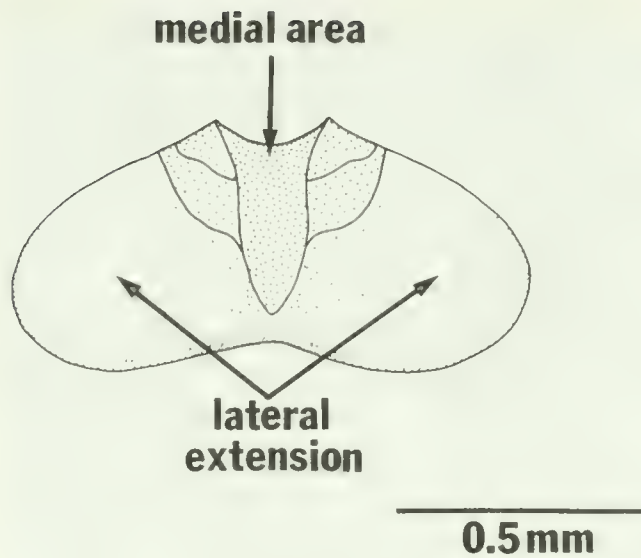
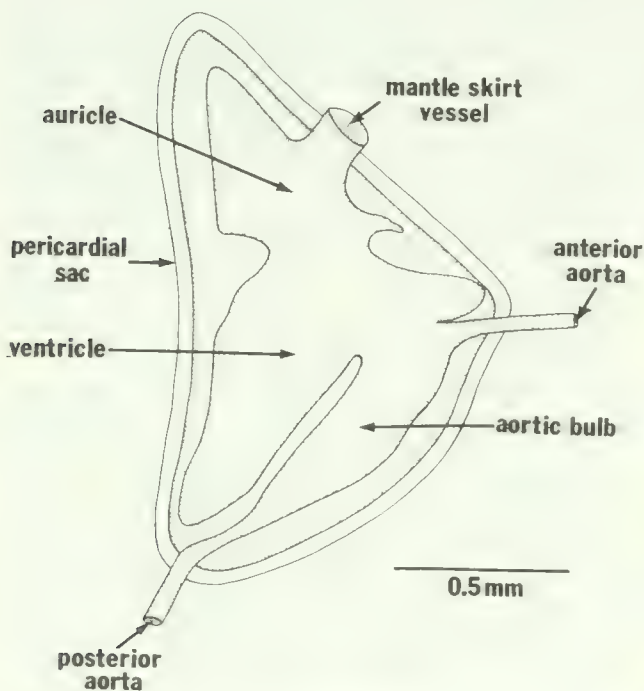
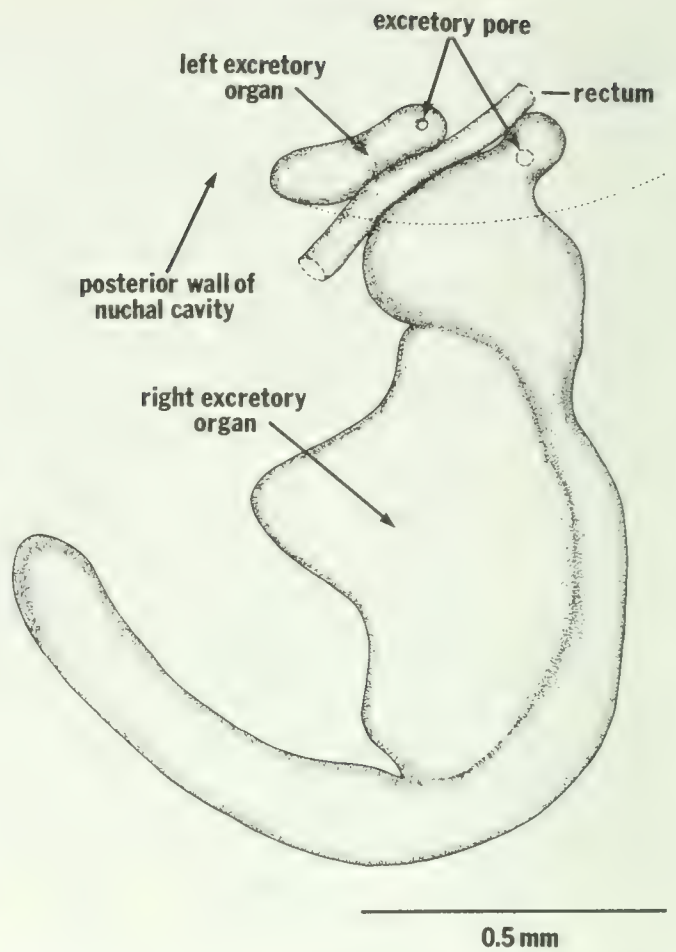
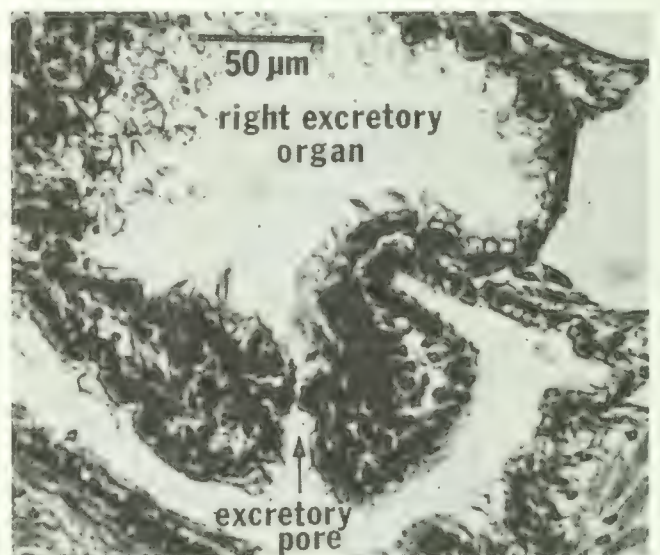

FIG. 10. Radular row of *Rhodopetala rosea*. (a) dentition, (b) lateral plate morphology.

FIG. 11. Jaw of *Rhodopetala rosea*.FIG. 12. Heart of *Rhodopetala rosea*.

(Fig. 6) and from the left and right circumpallial vessels. A small opening in the right lobe of the pericardial sac connects with the right and probably left excretory organs via the renopericardial canal.

**Excretory organs**—The left and right excretory organs are at the right side of the visceral mass (Fig. 13). The left excretory organ is oblong and, except for its posterior-most portion is enclosed within the mantle skirt (Fig. 6). The left excretory pore opens ventrally and is surrounded by a thickened lip. I could not locate the opening from the renopericardial canal into the left excretory organ. The right excretory organ also extends for a

FIG. 13. Excretory organs of *Rhodopetala rosea*.FIG. 14. Transverse section through the right excretory organ of *Rhodopetala rosea*.

short distance above the nuchal cavity, but most of it is inside of the visceral mass. The right excretory pore is ventral and surrounded by a thickened lip (Fig. 14). Immediately behind the nuchal cavity is a large left lobe into which the renopericardial canal opens; a

papilla and subanal lobe are absent. The right excretory organ narrows posteriorly and extends ventrally under the digestive gland. Further posterior, the right excretory organ narrows and continues along the posterior portion of the visceral mass and up the left side along the shell muscle.

**Reproductive system**—The single gonad lies on the left side of the visceral mass (Fig. 4), immediately extending behind the pericardial sac to the posterior shell muscle. To its left lies the shell muscle and on the right the stomach and digestive gland. I could not find a connection with the right excretory organ, but I do not doubt that it exists.

*Rhodopetala rosea* broods its young in the nuchal cavity (Golikov & Kussakin, 1972) and appears to be gonochoric unlike the hermaphroditic brooding acmaeids, *Problacmaea sybaritica* (Dall, 1871), *P. moskalevi* Golikov & Kussakin, 1972, and *Tectura rubella* (Fabricius, 1780). All 11 specimens including gravid individuals collected during the breeding season, which lasts from at least May to September, comprised separate sexes. There were no size differences suggestive of protandric hermaphroditism (Table 2).

#### DISTRIBUTION

USSR: Kuril Islands, Onekotan Island (49°25'N, 154°45'E) to Paramushir Island

(50°25'N, 155°50'E), and ALASKA: Aleutian Islands; Rat Islands, Kiska Island (51°57'N, 178°30'E) to Afognak Island (58°21'N, 152°30'W). Records (Fig. 15): (Western Pacific) USSR: Kuril Islands; Onekotan Island (Golikov personal communication, 1978), Paramushir Island (Golikov & Kussakin, 1972). (Eastern Pacific) ALASKA: Aleutian Islands; Rat Islands, Kiska Island (U.S. National Museum of Natural History #30789), Amchitka Island (Natural History Museum of Los Angeles County #71-252, National Museum of Natural Sciences, Ottawa #1976-30); Adak Island (San Diego Museum of Natural History #11610); Shumagin Islands, Simeonof Island [Type-locality] (U.S. National Museum of Natural History #213813, 30790, 635464); Sitkalidak Island and Afognak Island (Eyerdam, 1946).

#### ECOLOGY

Little is known of the ecology of *Rhodopetala rosea*. The limpets on which Golikov & Kussakin (1972) reported were collected from rocks and stones (Golikov personal communication, 1978). O'Clair (1977) reported *R. rosea* on the holdfasts and fronds of *Laminaria yezoensis* Miyabe, 1902 at Amchitka Island. Specimens were also collected from rock dominated by the coralline algae *Clathromorphum* spp. and *Thalassio-*

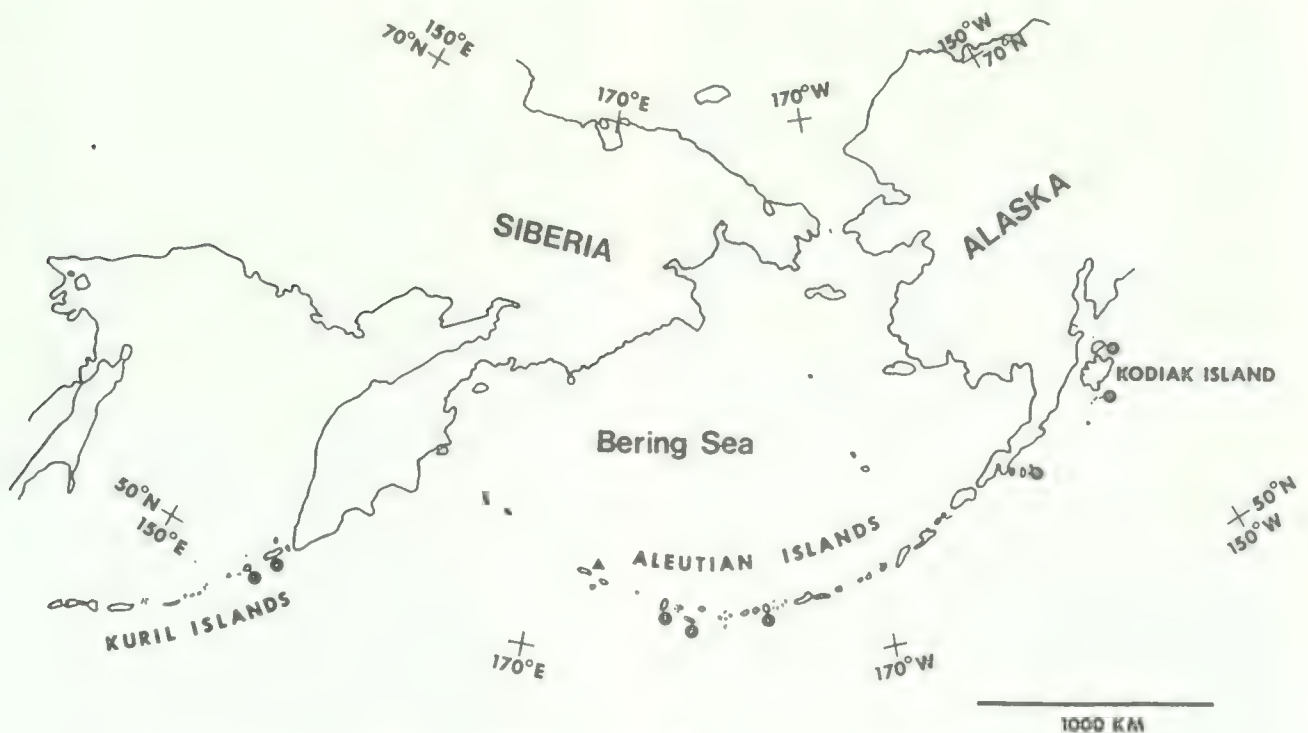

FIG. 15. Distribution of *Rhodopetala rosea* ● = collection records, ▲ = Attu Island.

*phylum clathrus* (Gmelin) Postels & Ruprecht, 1840 (O'Clair personal communication, 1979). O'Clair's specimens were collected from exposed and semiprotected intertidal areas between +2.0 feet (+0.6 m) and -2.0 feet (-0.6 m) (datum = mean lower low water). Asiatic specimens were found from the low intertidal to a depth of 10 m (Golikov personal communication, 1978).

Gut contents suggest that *R. rosea* feeds on both coralline algae and the cortical cells of laminarian algae. The shape of the radular teeth and their configuration suggests a diet of coralline algae, but bear little resemblance to those species that feed on laminarian algae (e.g. *Collisella instabilis* (Gould, 1846)). However, another species, *Collisella ochracea* (Dall, 1872), also feeds on both coralline and laminarian algae and has a radular morphology and configuration suggestive of only a coralline diet (Lindberg, 1979).

## DISCUSSION

The anatomy of *Rhodopetala rosea* is basically acmaeid, with several significant differences that set it apart from other members of the family. These are seen in the shell, respiratory system, circulatory system, and in the position of the excretory organs.

The shell structure of *R. rosea* is found in 15 species of the patellid genus *Cellana* (Table 5 of MacClintock, 1967) and is characterized by a complex crossed-lamellar layer inside of the myostracum. In all other acmaeids, except *Collisella scabra* (Gould, 1846) and *C. edmitchelli* (Lipps, 1966), the layer inside the myostracum is radial crossed-lamellar. In *C. scabra* and *C. edmitchelli* the inner layer is modified foliate (Lindberg, 1978). The common shell structure of *R. rosea* and the *Cellana* species strongly suggests a phyletic relationship between the two.

The gill of *R. rosea* differs markedly in structure and orientation from those of other previously studied acmaeids. In his classic account of the pallial organs of aspidobranch gastropods, Yonge (1947: 466) described the ctenidium of the Lottiidae [= Acmaeidae] as having "the usual structure with alternating filaments identical on the two sides." The acmaeid ctenidium arises from the left posterior wall of the nuchal cavity and extends to the right across the cavity.

Yonge's (1947) description of the structure and orientation of the acmaeid ctenidium cor-

roborates earlier studies by Willcox (1898, 1906), Fisher (1904), and Theim (1917b), and has been confirmed again in the Brazilian acmaeids by Righi (1966).

The gill of *R. rosea* arises from the nuchal cavity roof, not the left posterior wall of the nuchal cavity as reported in other acmaeids. The gill encloses a haemocoelic space through which the blood flows between marginal vessels (Fig. 7). Ctenidial filaments and distinct bands of cilia are absent. The only ciliary concentration is a group of long cilia on the left ventral surface. Similar outpocketings of the ventral mantle epithelium in the nuchal cavity of the lepetid limpet *Lothia coppingeri* Smith, 1882 have been reported by Moskalev (1977).

The gill of *R. rosea* appears analogous to the individual lappets that form the secondary gill of patellid and some acmaeid limpets. Each lappet has a marginal vessel that connects with a central haemocoelic space (Gibson, 1887; Davis & Fleure, 1903; Nuwayhid & Davies, 1978).

Structures of the digestive system of *R. rosea* are acmaeid-like. Whereas the patellid intestine typically has numerous, complex loops (Davis & Fleure, 1903; Fleure, 1904; Graham, 1932; Graham & Fretter, 1947), *R. rosea* has a simply looped intestine similar to eastern Pacific acmaeids (Walker, 1968). The esophagus of *R. rosea* is rotated approximately 135 degrees. Fleure (1904) reported that the maximum rotation of the acmaeid esophagus is 250 degrees, while in the Patellidae it is 270 to 330 degrees. While I cannot account for the limited rotation in *R. rosea*, it is far below the 270 degree minimum given for the Patellidae. The radula loops between the lobes of the digestive gland in a pattern similar to that of other eastern Pacific acmaeids (Walker, 1968), and not like that of *Cellana* species with which *R. rosea* shares shell structure (Theim, 1917a). The radular dentition and basal plate morphology are distinctly acmaeid. Although the radular teeth bear a superficial resemblance to those of *Acmaea* s.s. Eschscholtz, 1833, the complexity of the basal plates more closely resembles those found in members of the genera *Collisella* Dall, 1871 and *Notoacmea* Iredale, 1915.

The heart of *R. rosea* has both acmaeid and patellid features. In other acmaeids the efferent blood vessel from the ctenidium connects directly to the auricle (Willcox, 1898, 1906; Fisher, 1904; Fleure, 1904; Theim, 1917b; Righi, 1966; Kingston, 1968), and the



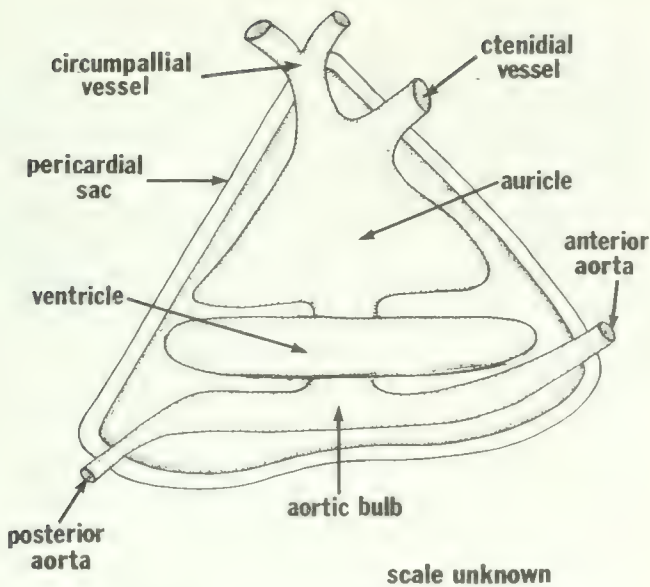

FIG. 16. Heart of acmaeid limpet. Redrawn from Fleure (1904).

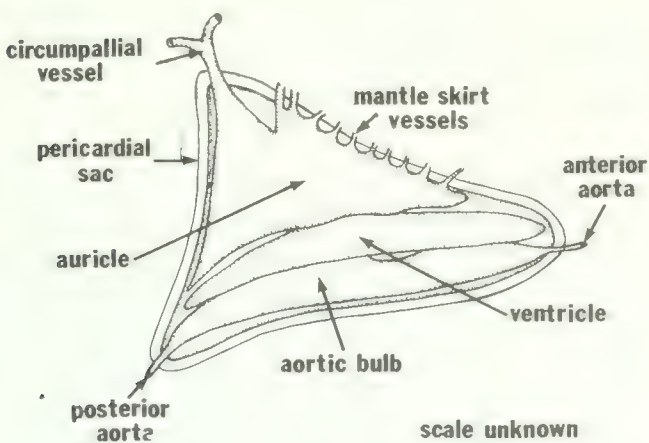

FIG. 17. Heart of patellid limpet. Redrawn from Fleure (1904).

circumpallial vessel enters the auricle immediately to the left of the ctenidial vessel (Fig. 16). The patellid heart (Fig. 17) is identical to the acmaeid heart but patellids lack a ctenidium and there is no ctenidial vessel. Instead, blood enters the auricle from the porous roof of the nuchal cavity (Fleure, 1904). As in acmaeids, blood also enters the auricle from the circumpallial vessel. *Rhodopetala rosea*, like other acmaeids, has a connection between the gill and auricle, but it is not a distinct vessel. Instead, blood from the gill is collected in the haemocoelic spaces that communicate with other haemocoelic spaces of the nuchal cavity roof. Here, blood passed through the gill is mixed with blood passed only through the nuchal cavity roof before it enters the auricle. There is not a distinct connection between the auricle and the circum-

pallial vessel. Instead, blood from the circumpallial vessels enters the porous roof of the nuchal cavity and proceeds to the heart. In this respect vessels of the auricle differ from both patellids and acmaeids (cf. Figs. 12, 16, 17).

The small size and rudimentary state of the gill of *R. rosea*, combined with the modifications of the auricle, suggest that the nuchal cavity roof is an important site for respiration. This same surface is thought to be a respiratory surface in the Patellidae (Fleure, 1904) and in other prosobranchs (Hyman, 1967: 205).

Typically in the Acmaeidae, the inner surface of the mantle margin is a secondary surface for respiration (Fisher, 1904; Kingston, 1968). Located here is the circumpallial sinus from which highly branched vessels arise and anastomose. Blood passes through this sinus before it is recollected and returned to the auricle through the circumpallial vessels. The tiny circumpallial sinus of *R. rosea* does not appear to be developed for respiration. Gas exchange on the mantle margin would be insignificant to gas exchange in the nuchal cavity roof through which all blood returning to the auricle passes. It is not clear if the roof of the nuchal cavity is a respiratory surface in other acmaeids. Circulatory patterns, as demonstrated with injection of dye in live and preserved specimens, have not implicated the roof of the nuchal cavity for respiration in other eastern Pacific species (Fisher, 1904; Kingston, 1968). Moreover, there are structural differences in the nuchal cavity roof of different species. Righi (1966: fig. 8) illustrated a large haemocoelic space in the roof of the nuchal cavity of *Collisella subrugosa* (Orbigny, 1841). In contrast, *Tectura rubella*, a brooding circumarctic species, has a very weakly developed space (Fig. 5b).

The excretory organs of other acmaeids and patellids lie behind the posterior wall of the nuchal cavity, the left excretory organ is much smaller than the right, and both open into the nuchal cavity through anterior excretory pores (Lankester, 1867; Gibson, 1887; Willcox, 1898, 1906; Davis & Fleure, 1903; Fisher, 1904; Theim, 1917b; Righi, 1966; Walker, 1968). In *R. rosea* the excretory organs are not totally behind the posterior wall of the nuchal cavity. Except for the posterior-most portion, the left excretory organ is within the mantle skirt above the nuchal cavity (Fig. 6). A corresponding portion of the larger right excretory organ also extends over the nuchal

cavity within the mantle skirt, but the bulk remains in the visceral mass. In addition, the excretory pores open ventrally into the cavity, not anteriorly as in other species. Otherwise, the location and size of the excretory organs are as in other acmaeids; the subanal lobe of the right excretory organ, reported in the Patellidae by Lankester (1867) is not present in *R. rosea*.

The reproductive systems of patellid and acmaeid limpets are very similar. In both families the gonad originates as a flat tubular structure appressed to the dorsal surface of the foot on the left side of the visceral mass. When gravid, the acmaeid gonad lies ventral to the visceral mass (Fisher, 1904; Righi, 1966; Walker, 1968). In the patellids, the gravid gonad lies ventral to the visceral mass, but also extends up the left side along the shell muscle (Gibson, 1887; Davis & Fleure, 1903; Branch, 1974). The presence of the gonad of *R. rosea* on the left side of the visceral mass appears to be a patellid feature.

The haemocoelic space in the nuchal cavity roof, the modifications of the circulatory system, and the position of the anterior portions of the excretory organs may be modifications of the nuchal cavity associated with brooding. The presence of young in the nuchal cavity would undoubtedly hamper water circulation and gas exchange along a typical ctenidium; thus modifications of the nuchal cavity roof for gas exchange may be an adaptation to increase the respiratory surface area. Correspondingly, circulatory patterns would be modified to ensure that oxygenated blood from the nuchal cavity roof would flow directly to the heart. Because of the rich blood supply of the excretory organs, the placement of the anterior portions in the mantle skirt may also serve to increase the respiratory surface (Fretter, personal communication, 1979).

Initially I thought that the disjunct distribution of *R. rosea* was an artifact of incomplete collecting in the Aleutian Islands. However, thorough searches of intertidal and subtidal localities on Attu Island (Fig. 15) over a 5 week period failed to procure a single specimen of *R. rosea*. Therefore, the disjunct distribution of *R. rosea* may, in part, be real.

In summary, the anatomy of *R. rosea* indicates that this species is an acmaeid limpet. The distinguishing characters are a gill in the nuchal cavity, rotation of the esophagus, looping of the intestine and radula, radular dentition, and the proportions of the right excretory

organ. Major modifications have occurred in the respiratory and circulatory systems, notably the reduction of the ctenidium to a vestigial state, use of the nuchal cavity roof as a respiratory surface, and corresponding changes in vessels associated with the auricle of the heart. These deviations from typical acmaeid anatomy, combined with the unique shell structure warrant a separate subfamilial category within the Acmaeidae, and I therefore propose the following new taxon.

## SYSTEMATICS

### MOLLUSCA

Gastropoda Cuvier, 1797

Archaeogastropoda Thiele, 1925

Patellacea Rafinesque, 1815

Family Acmaeidae Forbes, 1850

Acmaeidae Forbes, 1850: 76.

Tecturidae Gray, 1847: 158.

Lottiidae Habe, 1944: 171.

### Diagnosis

Shell conical or cap-shaped, apex positioned between middle and anterior of shell; myostracum horseshoe-shaped, open anteriorly. Radula docoglossate; marginal teeth one or two pairs or absent, lateral teeth three pairs, rachidian tooth lacking. Nuchal cavity with single gill; secondary gill in mantle groove present in some genera.

Triassic to Recent.

Rhodopetalinae subfam. nov.

Type-genus *Rhodopetala* Dall, 1921: 171.

### Diagnosis

Shell helcioniform, apex positioned at anterior quarter of shell, submarginal. Marginal teeth lacking, lateral teeth approximately equal in size and shape. Gill rudimentary, situated medially at back of nuchal cavity; secondary gill absent. Shell structure of 5 layers, outer surface and interior margin complex prismatic, followed by foliate, radial crossed-lamellar, myostracum, and complex crossed-lamellar layers.

Recent.

## Remarks

The subfamily Rhodopetalinae is distinguished from other acmaeid subfamilies by a helcioniform rather than conical shell, an interior central area with a silvery metallic lustre rather than a porcelaneous central area found in other subfamilies, and the presence of a rudimentary gill that lacks typical ctenidial structures.

Only the monotypic genus *Rhodopetala* is assignable to this subfamily. Fossil members of Rhodopetalinae are not known, but could be recognized by a helcioniform shell belonging to MacClintock's (1967) shell structure group no. 12. All limpets with this shell structure have been thought to belong to the Patelidae, but I believe that the group no. 12 shell structure and the acmaeid-like anatomy suggest that the Rhodopetalinae is an ancestral intermediate group between acmaeid and cellanid limpets.

## ACKNOWLEDGEMENTS

I acknowledge Dr. J. H. McLean (Natural History Museum of Los Angeles County) for providing specimens of *Rhodopetala rosea* for study. I am grateful to Drs. McLean, V. Fretter (University of Reading, England), and J. S. and V. B. Pearse (University of California, Santa Cruz) for providing valuable criticism and comments on the manuscript. Dr. C. E. O'Clair (Auke Bay Fisheries Laboratory, Alaska) provided additional specimens and habitat notes from Amchitka Island, Alaska, and Dr. A. N. Golikov (Academy of Sciences, Leningrad) provided habitat and locality data for the Asiatic specimens of *R. rosea*. Specimens of *Tectura rubella*, for comparison, were kindly provided by Dr. J.-A. Sneli (Universitetet i Trondheim, Norway). This study was made possible by the histological talents of Dr. D. E. Dunn (California Academy of Sciences), Ms J.-C. Ramsaran (Natural History Museum of Los Angeles County), and especially Dr. A. T. Newberry (University of California, Santa Cruz). The anatomical drawings were prepared by Ms J. A. Christmann (University of California, Santa Cruz).

## LITERATURE CITED

- ADAMS, H., 1869, Descriptions of a new genus and fourteen new species of marine shells. *Proceedings of the Zoological Society of London*, 1869: 272–275, pl. 19.
- BRANCH, G. M., 1974, The ecology of *Patella* Linnaeus from the Cape Peninsula, South Africa. 2. Reproductive cycles. *Transactions of the Royal Society of South Africa*, 41: 111–160.
- BURCH, J. Q., 1946, Family Acmaeidae. *Minutes of the Conchological Club of Southern California*, 57: 5–16.
- CHRISTIAENS, J., 1976, De familie Acmaeidae. *Gloria Maris*, 15(3): 49–64.
- CUVIER, G., 1797, *Tableau élémentaire de l'histoire naturelle des animaux*. Paris, 710 p.
- DALL, W. H., 1869, Materials for a monograph of the family Lepetidae. *American Journal of Conchology*, 5: 140–150, pl. 15.
- DALL, W. H., 1871, On the limpets; with special reference to the species of the west coast of America, and to a more natural classification of the group. *American Journal of Conchology*, 6: 227–282.
- DALL, W. H., 1872, Preliminary descriptions of new species of mollusks from the northwest coast of America. *Proceedings of the California Academy of Sciences*, 4: 270–271, pl. 1.
- DALL, W. H., 1921, Summary of the marine shell-bearing mollusks of the northwest coast of America, from San Diego, California, to the Polar Sea, mostly contained in the collection of the United States National Museum, with illustrations of hitherto unfigured types. *United States National Museum Bulletin*, 112: 1–217.
- DAVIS, J. R. A. & FLEURE, H. J., 1903, *Patella* (The Common Limpet). *Liverpool Marine Biological Committee Memoir*, 10: 1–76.
- ESCHSCHOLTZ, F., 1833, In: RATHKE, H., *Zoologischer Atlas, enthaltend Abbildungen und Beschreibungen neuer Thierarten, während des Flottcapitains von Kotzebue zweiter Reise um die welt... in... 1823–26 beobachtet von... F. Eschscholtz*. Part 5, Berlin, 28 p.
- EYERDAM, W. J., 1946, In: BURCH, J. Q., *Minutes of the Conchological Club of Southern California*, 57: 15.
- FISHER, W. K., 1904, The anatomy of *Lottia gigantea* Gray. *Zoologische Jahrbucher*, 20: 1–66.
- FLEURE, H. J., 1904, On the evolution of topographical relations among the Docoglossa. *Transactions of the Linnean Society of London*, 9: 269–290.
- FORBES, E., 1850, On the genera of British Patellacea. *Reports of the British Association for the Advancement of Science*, 1849, Part 2: 75–76.
- GIBSON, R. J. H., 1887, Anatomy and physiology of *Patella vulgata*. Part I. Anatomy. *Transactions of the Royal Society of Edinburgh*, 32: 601–638.
- GOLIKOV, A. N. & KUSSAKIN, O., 1972, Sur la biologie de la reproduction de patelles de la famille Tecturidae (Gastropoda: Docoglossa) et sur la position systématique de ses subdivisions. *Malacologia*, 11: 287–294.

- GRAHAM, A., 1932, On the structure and function of the alimentary canal of the limpet. *Transactions of the Royal Society of Edinburgh*, 57: 287–308.
- GRAHAM, A. & FRETTER, V., 1947, The life history of *Patina pellucida* (L.). *Journal of the Marine Biological Association of the United Kingdom*, 26: 590–601.
- GRAY, J. E., 1847, A list of the genera of Recent Mollusca, their synonyma and types. *Proceedings of the Zoological Society of London*, 1847: 129–219.
- HABE, T., 1944, On the Japanese Lottiidae (= Acmaeidae). *Japanese Journal of Malacology (Venus)*, 13: 171–187.
- HYMAN, L. H., 1967, *The Invertebrates*, Volume VI, Mollusca I. McGraw-Hill, New York, 792 p.
- IREDALE, T., 1915, A commentary on Suter's Manual of the New Zealand Mollusca. *Transactions and Proceedings of the New Zealand Institute*, 1914, 47: 417–497.
- KEEN, A. M., 1937, *An Abridged Check List and Bibliography of West North American Marine Mollusca*. Stanford University Press, Stanford, California, 87 p.
- KEEN, A. M., 1960, Family Patellidae Rafinesque, 1815. In: MOORE, R. C., (ed.), *Treatise on Invertebrate Paleontology, Part I, Mollusca 1*, Geological Society of America & University of Kansas Press, Lawrence, Kansas, p. 234–235.
- KINGSTON, R. S., 1968, Anatomical and oxygen electrode studies of respiratory surfaces and respiration in *Acmaea. Veliger*, 11 (Supplement): 73–78.
- KNIGHT, J. B., COX, L. R., KEEN, A. M., BATTEN, R. L., YOCHELSON, E. L., & ROBERTSON, R., 1960, Archaeogastropoda. In: MOORE, R. C., (ed.), *Treatise on Invertebrate Paleontology, Part I, Mollusca 1*, Geological Society of America & University of Kansas Press, Lawrence, Kansas, p. 169–310.
- LANKESTER, E. R., 1867, On some undescribed points in the anatomy of the limpet (*Patella vulgata*). *Annals and Magazine of Natural History*, 20: 334–337.
- LINDBERG, D. R., 1977, The enigmatic *Rhodopetala*. *Western Society of Malacologists Annual Report*, 10: 7.
- LINDBERG, D. R., 1978, On the taxonomic affinities of *Collisella edmittchelli* (Lipps) (Gastropoda: Acmaeidae), a late Pleistocene limpet from San Nicolas Island, California. *Bulletin of the Southern California Academy of Sciences*, 77: 65–70.
- LINDBERG, D. R., 1979, Variations in the limpet *Collisella ochracea* and the northeastern Pacific distribution of *Notoacmea testudinalis* (Acmaeidae). *The Nautilus*, 93: 50–56.
- MACCLINTOCK, C., 1967, Shell structure of patelloid and bellerophonoid gastropods (Mollusca). *Peabody Museum of Natural History Yale University Bulletin*, 22: 1–140.
- MCLEAN, J. H., 1966, *West American Prosobranch Gastropoda: Superfamilies Patellacea, Pleurotomariacea, and Fissurellacea*. Ph.D. Dissertation, Stanford University, Stanford, California, 255 p.
- MONTFORT, P. D. DE, 1808–1810, *Conchyliologie systématique, et classification méthodique des coquilles . . .*, Paris, 2 vols.
- MOSKALEV, L. I., 1977, To the revision Lepetidae (Gastropoda, Prosobranchia) of world ocean. *Trudy Instituta Okeanologii, Akademiya Nauk SSSR*, 108: 52–78 [in Russian].
- NUWAYHID, M. A. & DAVIES, P. S., 1978, Gill structure in the common limpet *Patella vulgata*. *Journal of the Marine Biological Association of the United Kingdom*, 58: 817–823.
- O'CLAIR, C. E., 1977, Marine Invertebrates in Rocky Intertidal Communities. Chapter 18 In: *The Environment of Amchitka Island, Alaska*. MERRILL, M. L. & FULLER, R. G., (eds.). Technical Information Center, U.S. Energy Research and Development Administration, Springfield, Virginia, 682 p.
- OLDROYD, I. S., 1927, *The Marine Shells of the West Coast of North America*, Volume 2, Part 3. Stanford University Press, Stanford, California, 339 p.
- PILSBRY, H. A., 1891, Acmaeidae, Lepetidae, Patellidae, Titiscaniidae. *Manual of Conchology: Structure and Systematics*, Volume 13, Philadelphia, Pennsylvania, 195 p.
- POWELL, A. W. B., 1973, The patellid limpets of the World (Patellidae). *Indo-Pacific Mollusca*, 3(15): 75–206.
- RAFINESQUE, C. S., 1815, *Analyse de la Nature, ou Tableau de l'univers et des corps organisés*. Palermo, 224 p.
- RIGHI, G., 1966, On the Brazilian species in the *Acmaea subrugosa* complex (Gastropoda: Prosobranchia: Patellacea). *Malacologia*, 4: 269–295.
- SCHUMACHER, C. F., 1817, *Essai d'un Nouveau Système des Habitations des vers Testacés avec XXII planches*. Copenhagen, 287 p.
- SOWERBY, G. B. (II), 1839, *A Conchological Manual*. London, 134 p.
- THEIM, H., 1917a, Beiträge zur Anatomie und Phylogenie der Docoglossen; I, zur Anatomie von *Helcioniscus ardosiaeus* Hombron et Jacquinot unter Bezugnahme auf die Bearbeitung von Erich Schuster in den Zoolog. Jahrb., Supplement XIII, Bd., IV, 1913. *Jenaische Zeitschrift Naturwissenschaft*, 54: 333–404.
- THEIM, H., 1917b, Beiträge zur Anatomie und Phylogenie der Docoglossen; II, Die Anatomie und Phylogenie der Monobranchen (Akmäiden und Scurriiden nach der Sammlung Plates). *Jenaische Zeitschrift Naturwissenschaft*, 54: 405–630.
- THIELE, J., 1925–1926, *Mollusca = Weichtiere: Handbuch der Zoologie, begründet W. Küenthal*, Volume 5, Berlin, Leipzig, 275 p.
- WALKER, C. G., 1968, Studies on the jaw, diges-

- tive system, and coelomic derivatives in representatives of the genus *Acmaea*. *Veliger*, 11 (Supplement): 88–97.
- WILLCOX, M. A., 1898, Zur Anatomie von *Acmaea fragilis* Chemnitz. *Jenaische Zeitschrift Naturwissenschaft*, 32: 411–456.
- WILLCOX, M. A., 1906, Anatomy of *Acmaea testudinalis* Müller, Part 1. Introductory material—external anatomy. *American Naturalist*, 40: 171–187.
- YONGE, C. M., 1947, The pallial organs in the aspidobranch Gastropoda and their evolution throughout the Mollusca. *Philosophical Transactions of the Royal Society of London, Series B. Biological Science*, 232(591): 443–518.



## A RELICT NEOGENE CAENOGASTROPOD FAUNA FROM NORTHERN SOUTH AMERICA

Edward J. Petuch<sup>1</sup>

*Rosenstiel School of Marine and Atmospheric Science,  
4600 Rickenbacker Causeway, Miami, Florida 33149, U.S.A.*

### ABSTRACT

A previously unknown relict Neogene gastropod fauna has been found to exist in shallow water near upwelling systems along northern Colombia and Venezuela. Forty-five relict caenogastropods of the families Turritellidae, Calyptraeidae, Naticidae, Cypraeidae, Cassidae, Ficidae, Muricidae, Columbellidae, Buccinidae, Fasciolaridae, Olividae, Mitridae, Volutomitridae, Volutidae, Marginellidae, Cancellariidae, Conidae, Terebridae, and Turridae, are re-described and their Recent and fossil distributions outlined. Also reported from the upwelling areas are the paciphilic genera *Agladrillia*, *Aphera*, and *Truncaria*, and the relict Neogene genera *Conomitra*, *Panamurex* s.s., and *Paraborsonia*. Based on the unusual ecological conditions in which the relicts have been found to be living and on their paleozoogeography, the hydrographic and substrate parameters of the Neogene southern Caribbean are conjectured. A possible ecological barrier to tropical molluscivorous predation is proposed as an explanation for the existence of several thin-shelled, shallow water relict gastropods.

### INTRODUCTION

To both the systematist and the zoogeographer, the Recent shallow water inner shelf (0-100 m) molluscan fauna of northern South America is an enigma. Although still poorly known and never completely surveyed, this area contains a remarkable fauna with an unusually high degree of endemism. Not only are many of the mollusks of the northern South American coastline restricted to that area, they also show few affinities with mollusks from the surrounding Caribbean region. The existence of this anomalous faunal pocket in the center of the Caribbean Molluscan Province has generated many unanswered questions about the origin of the tropical western Atlantic molluscan fauna and its relationship to other faunas around the world.

I first became interested in the northern South American mollusks during a series of collecting trips starting in 1974 and ending in 1979. During this time, I had several opportunities to work on Colombian and Venezuelan commercial shrimp boats and was able to sample a large number of previously unexplored offshore areas. Since the shrimp fleets are restricted to their own national territorial waters, the sample areas were limited to the Colombian and Venezuelan continental

shelves. Within this sampling area, however, a particularly interesting molluscan assemblage was encountered. As the shrimpers moved up the coast of Colombia toward the Guajira Peninsula, large numbers of unusual mollusks were taken with increasing regularity. The numbers of species seen in the net hauls reached maximum level in the area of the Golfo de Venezuela, Peninsula de Paraganá, and Golfo de Triste, Venezuela. A rich molluscan fauna was encountered along this coast, containing a large proportion of previously unknown living species. Upon resumption of my research work at the University of Miami in 1976, I had the opportunity to work with the R/V Pillsbury expedition collections taken during cruises along the Colombian and Venezuelan coasts in 1966 and 1968. These extensive collections supported my findings and added several more anomalous mollusks to a rapidly growing species list.

The unexpectedly large number of species of mollusks of all classes from the area around the Golfo de Venezuela made it necessary to restrict the scope of my studies. The paper presented here deals only with the higher prosobranch gastropod families containing members with average adult shell lengths of over 15 mm. Even with this restriction, the caenogastropod families covered in,

<sup>1</sup>Present address: Department of Zoology, University of Maryland, College Park, Maryland 20742, U.S.A.

this study are still among the best indicators of the distribution of shallow water benthic assemblages. As highly specialized animals, they are often tightly restricted in their habitat preferences and, for this reason, are a powerful tool for determining zoogeographic patterns. These families are also well represented in the fossil record of the Caribbean region, and are excellent organisms for tracing the evolutionary trends in the western Atlantic.

When I began to analyze the material from my field work and that of the R/V Pillsbury collections, it became apparent that a considerable part of the Colombian and Venezuelan caenogastropods could not be assigned to any known Recent fauna. A review of the literature of the Caribbean fossil mollusks showed that these living gastropods were, in fact, previously unknown Miocene and Pliocene relicts. From the diversity of this relict fauna, it became evident that Plio-Pleistocene glacial sea level fluctuations and temperature changes failed to destroy completely all Neogene shallow water molluscan assemblages in the Caribbean region. As pointed out by myself (1976: 323-325) and Vermeij (1978: 231-237), the shallow water area along northern South America has acted as a refugium. The full extent and size of the fauna of this refugium, however, was previously unknown and greatly underestimated. The following description of an extant Neogene molluscan assemblage, together with a review of the literature on the Recent and fossil caenogastropods of northern South America, sheds more light on the spatial and temporal heterogeneity of the Recent tropical western Atlantic molluscan fauna.

## MATERIALS AND METHODS

### Collections studied

The specimens of the relict caenogastropods that form the framework of this study are part of four collections. The first of these comprised several hundred lots taken by myself while shore collecting and working on shrimp boats along the Colombian and Venezuelan coasts from 1974 to 1979. This collection was divided and deposited at the National Museum of Natural History, Smithsonian Institution, and in the Invertebrate Museum collection of the Rosenstiel School of Marine and Atmospheric Science, University of Miami.

The second was that of the R/V Elliott Pills-

bury, taken as part of two oceanographic surveys of the southern Caribbean in 1966 and 1968 and is housed in the Invertebrate Museum of the Rosenstiel School. It represents several thousand lots of wet and dry, sorted and unsorted material.

The third collection used was that of the Universidad Simón Bolívar Marine Laboratory at Puerto Cabello, Venezuela, and was examined by me in March, 1979. This largely unsorted collection contains several hundred lots of caenogastropods, with most of the specimens coming from the shrimp trawlers that fish the adjacent Golfo de Triste. Dr. P. Penchaszadeh, Director of the laboratory, kindly donated a large number of specimens and these are now housed at the Smithsonian Institution along with my original study collection. Considering the small size of the collection, it contained a disproportionately large number of relict species. These specimens indicate the large size of the poorly-known Golfo de Triste relict pocket.

In March, 1979, I studied the extensive collection of fossil and Recent material of Dr. and Mrs. J. Gibson-Smith, of Caracas, Venezuela. Within this collection were housed several thousand lots of caenogastropods, including virtually complete collections of the gastropods of the Cabo Blanco, Mare, and Cantaure formations. The Gibson-Smiths kindly donated a number of important specimens which now reside in the Smithsonian Institution mollusk collection. Access to both this collection and that of the Universidad Simón Bolívar Marine Laboratory enabled me to compare Recent Golfo de Triste material with well-preserved fossils. Many of my initial species determinations came from these comparisons.

Collecting was limited to a depth range of 0-100 m. These depths incorporate, in an oceanographic sense, a shallow water range and encompass the range of my shore collecting, shrimp boat work, and the pertinent R/V Pillsbury stations. The R/V Pillsbury collections were taken with 10 and 40 foot otter trawls following one-half to one hour hauls. The stations are given in Appendix 1. The commercial shrimp boats working along northern South America use two 10 foot otter trawls much like those of the R/V Pillsbury, but usually haul them for three to six hours, running at about 1-2 knots. The collected material is then sorted on deck.

Shore collecting involved either beach collecting, as was done along the Colombian coast near Cartagena and Riohacha, or by



wading in shallow bays, such as Bahía Amuay on the Peninsula de Paraguaná, Venezuela (Petuch, 1976). This limited means of collecting was a result of the extremely turbid water conditions along this coast which, in turn, prevents skin or SCUBA diving.

#### Methods of analysis

For positive identification, the relicts were compared to fossil specimens either in the literature or in the Gibson-Smith collection. Particularly useful were the works of Jung (1965, 1969), Woodring (1959, 1964, 1970), and Weisbord (1962), all of which clearly illustrate and describe the fossil holotypes of many of the extant species. Pflug's 1969 study was the most valuable comparison work because of its illustrations of the lectotypes of Sowerby's Santo Domingo fossils. The relicts collected along the Colombian and Venezuelan coasts are illustrated here to permit comparison with the specimens, fossil and living, illustrated in other works.

Abbreviations used in this study include:

UMML—Invertebrate Museum Collection, Rosenstiel School of Marine and Atmospheric Science, University of Miami.

USNM—Collection of the Division of Mollusks, National Museum of Natural History, Smithsonian Institution.

P-000—R/V John Elliott Pillsbury station number.

#### LITERATURE ON THE SYSTEMATICS OF THE NORTHERN SOUTH AMERICAN CAENOGASTROPODS

Very little work has been done on the systematics of the Recent shallow water caenogastropod fauna of the Colombian and Venezuelan coasts. Dautzenberg (1900) was the first to publish on the molluscan fauna of this area, using material from the cruise on the yacht "Chazalie." Clench, in the *Johnsonia* series of monographs starting in 1941, published scattered records and single species descriptions for many caenogastropod families; particularly noteworthy were the works on the Conidae (1942, 1953), Muricidae (1945) (with Pérez Farfante) and (1959), Thaididae (1947), and Cassidae (1944). Most of his material came from private collectors who had visited

the area over the early decades of this century. Much of this material is deposited in the Museum of Comparative Zoology, Harvard University, and in the National Museum of Natural History and was Clench's primary source of southern Caribbean records during the war years of 1941–1945.

No compendium or species checklist was undertaken for the Colombian and Venezuelan coastlines until 1962 when Rehder published the first survey of the area in his study of the mollusks of Los Roques and La Orchila Islands off the coast of Venezuela. In large monographic revisions of muricid genera, Bullis (1964), E. Vokes (1967a, b, 1968, 1974, 1975) and Gertman (1969) included new species from Colombian and Venezuelan waters. The Cassidae of northeast Venezuela was outlined by Flores (1966) while Work (1969) continued Rehder's pioneer study by producing the first extensive checklist of the Los Roques molluscan fauna. This not only included a species list, as did Rehder's, but also covered aspects of the ecology and zoogeography of many of the species. The German biologists, Kaufmann & Götting (1970), working from the Instituto Colombo-Alemán at Santa Marta, Colombia, compiled the first species list of shallow water gastropods from the Colombian coast. This list is invaluable because of its excellent illustrations.

The 1970's saw an end to the incognita status of coastal northern South American waters. Bayer (1971) redescribed and illustrated several shallow water Colombian and Venezuelan muricids (pp. 151–169). The families Thaididae and Muricidae of the shallow waters of Venezuela were outlined in detail by Gonzalez & Flores (1972). In 1973, Flores (1973a, b) published two papers on the ecology and systematics of the family Littorinidae in Venezuela that clarified for the first time the morphologically conservative *Littorina ziczac* species complex. Also in 1973, J. Gibson-Smith outlined the living and fossil *Voluta* from the Venezuelan coast and described two new fossil species. The molluscan faunas of Isla Margarita, Isla Cubagua, and Isla Coche, Venezuela were surveyed by Princz (1973). His was the first work to correlate species assemblages with shallow water biotopes. J. Gibson-Smith & W. Gibson-Smith (1974) reviewed the Recent and fossil Venezuelan columbellids of the genus *Strombina* and described the second known living Atlantic species. Although outside the

scope of Venezuelan and Colombian waters, the species list published by Altena (1975) on the gastropods of Surinam is of particular interest to Caribbean workers. It not only illustrates the first known living Caribbean *Fusiturricula* but also describes and illustrates many gastropods from neighboring Venezuela and Colombia. The first compendium of Venezuelan mollusks, both fossil and living, was published by Tello in 1975. The caenogastropod section alone covers 132 pages and contains detailed species records and literature citations. The genus *Voluta* in Colombia was outlined in detail by von Cosel (1976), who also worked from the Instituto Colombo-Alemán, Santa Marta. He delineated a possible zoogeographic barrier near the mouth of the Rio Magdalena. Similarly, Vink (1977) described the Conidae of the *Conus cedonulli* species complex of the Southern Caribbean and described a new species endemic to the Santa Marta area. Based on the distributions of the various cone species, several zoogeographic barriers were also suggested. In 1979, I reviewed the relict cypraeid genus *Siphocypraea* and described a new Colombian-Venezuelan species. Following the examples of my predecessors, I incorporated into this study aspects of the ecology and zoogeography of the living siphocypraeas.

#### LITERATURE ON THE PALEONTOLOGY OF THE NORTHERN SOUTH AMERICAN CAENOGASTROPODS

In 1850, G. B. Sowerby I undertook the first review of the fossil gastropods of the Caribbean area. This landmark work described new species collected by Colonel Heneken in Santo Domingo. The tremendous diversity of the preglacial Caribbean region was further documented by Gabb (1860 and 1881) who described many new species from Costa Rica. In 1873 and 1875, he added more new taxa to Sowerby's original Santo Domingo species list. By far the most prolific of his contemporaries, R. J. L. Guppy published over forty works on Caribbean fossil mollusks between the years 1863 and 1911. Most noteworthy are his studies of the Jamaican fossils (1866 and 1873) and those of Trinidad (1909 and 1911). Maury (1912, 1917, and 1925) also described large numbers of new fossil gastropods from Santo Domingo and Trinidad.

These initial studies laid the groundwork for

a rich literature, making the Caribbean Tertiary fossil gastropods one of the best-studied molluscan faunas in the New World. Following the works of Gabb, Olsson (1922 and 1942) further expanded on the fossils of Costa Rica and described many new Pliocene species. The apogee of early twentieth century paleontological studies was reached in Woodring's 1928 work on the Pliocene mollusks of the Bowden formation of Jamaica. Woodring's techniques and field experience culminated in his incomparable group of works on the Gatun formation of Panamá (1957, 1959, 1964, and 1970). Containing new species descriptions, faunal correlations, and paleoecological data, these five volumes together are the single most important contribution to the evolutionary history of the Caribbean mollusks. Although containing no new species descriptions, Pflug's 1961 study on the Santo Domingo caenogastropods is extremely important because of the illustrations of many unfigured lectotypes of Sowerby's species. Jung (1969), on the other hand, added to the faunal diversity of the Pliocene of Trinidad by describing many new caenogastropods. His works on the fossils of the poorly-known Peninsula de Paraguaná, Venezuela (1965), and Carriacou (1971) have facilitated the correlation of fossil assemblages from other areas of the Caribbean. The unusual Pliocene gastropod fauna of Ecuador was described in detail by Marks (1951) and Olsson (1964), as was that of the Isthmus of Tehuantepec, Mexico by Perrilliat-Montoya (1963). These works were particularly useful in the formation of my concept of provinciality in the preglacial Caribbean and in establishing provincial boundaries. Weisbord (1962) produced another large and important work on the upper Pliocene-Pleistocene gastropod faunas of northern Venezuela. This study described some of the youngest formations in the southern Caribbean and made it possible to correlate those faunas with the older assemblages outlined by Woodring and Olsson.

Besides the research on entire molluscan faunas, there are a number of important paleontological studies on specific southern Caribbean gastropod genera and families. Of particular importance to my work were the publications of Schilder (1939) and Ingram (1939, 1947a, b) on the Cypraeidae, Olsson (1965), J. Gibson-Smith (1976), and S. Hoerle & E. Vokes (1978) on the Volutidae, E. Vokes (1967a, b, 1968, 1970, 1974 and 1975) on the

Muricidae, J. Gibson-Smith & W. Gibson-Smith (1974) on the genus *Strombina*, and Hodson (1926) on the Turritellidae.

## DISCUSSION

The Colombian-Venezuelan Neogene relict pocket represents the oldest known intact shallow water molluscan fauna in the western Atlantic. The Gulfs of Venezuela and Triste regions contain extant elements of several well-documented Neogene Caribbean fossil formations. Of the forty-five additional extant species reported in the following systematic section and shown here in Table 1, nineteen have also been found in the Bowden formation of Jamaica, fifteen in the Gurabo formation of Santo Domingo, seventeen in the Gatun formation of Panamá, four from the Grand Bay formation of Carriacou, and twelve from the Mare and Cabo Blanco formations of Venezuela. The widespread Neogene genera *Conomitra*, *Panamurex* s.s., and *Paraborsonia*, previously thought to have been extinct since preglacial times, have been found to be living components of the relict assemblage. The paciphilic genera *Agladrillia*, *Aphera*, and *Truncaria* are also present in the relict pocket and represent the first records of these taxa in the Recent Atlantic. The archaic genera *Fusiturricula*, *Siphocypraea*, *Strombina*, and *Subcancilla*, previously thought to be represented in the Caribbean by one or only a few species, have been found to be more diverse. These diversity trends, along with the presence of relict and paciphilic genera, emphasize the anachronistic aspect of the fauna and its closeness to the Recent Panamic Molluscan Province.

Table 1. Additional relict species from northern South America.

---

Turritellidae
1. <i>Turritella paraguensis</i> F. Hodson, 1926
Calyptraeidae
2. <i>Crucibulum mareense</i> Weisbord, 1962
3. <i>Crucibulum springvaleense</i> Rutsch, 1942
Naticidae
4. <i>Natica stenopa</i> Woodring, 1957
Cypraeidae
5. <i>Siphocypraea henekeni</i> (Sowerby, 1850)
Cassidae
6. <i>Morum dominguense</i> (Sowerby, 1850)
7. <i>Sconsia laevigata</i> (Sowerby, 1850)

TABLE 1 (Continued)

---

Ficidae
8. <i>Ficus pilsbryi</i> (B. Smith, 1970)
Muricidae
9. <i>Panamurex gatunensis</i> (Brown & Pilsbry, 1911)
Columbellidae
10. <i>Strombina caboblanquensis</i> Weisbord, 1962
11. <i>Strombina</i> sp.
Buccinidae
12. <i>Antillophos elegans</i> (Guppy, 1866)
13. <i>Truncaria</i> sp.
Fasciolaridae
14. <i>Latirus anapetes</i> Woodring, 1964
15. <i>Fusinus caboblanquensis</i> Weisbord, 1962
16. <i>Fusinus marensis</i> Weisbord, 1962
Olividae
17. <i>Ancilla venezuelana</i> Weisbord, 1962
18. <i>Ancilla</i> sp.
19. <i>Oliva schepmani</i> Weisbord, 1962
Mitridae
20. <i>Subcancilla illacidata</i> (Woodring, 1928)
21. <i>Subcancilla rhadina</i> (Woodring, 1928)
22. <i>Subcancilla venezuelana</i> (F. Hodson, 1931)
Volutomitridae
23. <i>Conomitra caribbeana</i> Weisbord, 1929
24. <i>Conomitra lehneri</i> Jung, 1971
25. <i>Conomitra</i> sp.
Volutidae
26. <i>Lyria</i> cf. <i>limata</i> S. Hoerle and E. Vokes, 1978
Marginellidae
27. <i>Persicula hodsoni</i> Weisbord, 1962
Cancellariidae
28. <i>Agatrix epomis</i> (Woodring, 1928)
29. <i>Aphera islacolonis</i> (Maury, 1917)
Conidae
30. <i>Conus consobrinus</i> Sowerby, 1850
31. <i>Conus planiliratus</i> Sowerby, 1850
32. <i>Conus symmetricus</i> Sowerby, 1850
Terebridae
33. <i>Strioterebrum bowdenensis</i> (Woodring, 1928)
34. <i>Strioterebrum gatunensis kugleri</i> (Rutsch, 1934)
35. <i>Strioterebrum ischna</i> (Woodring, 1928)
36. <i>Strioterebrum quadrispiralis</i> (Weisbord, 1962)
37. <i>Strioterebrum trispiralis</i> (Weisbord, 1962)
Turridae
38. <i>Polystira barretti</i> (Guppy, 1866)
39. <i>Agladrillia lassula</i> Jung, 1969
40. <i>Hindsiclava consors</i> (Sowerby, 1850)
41. <i>Fusiturricula acra</i> (Woodring, 1970)
42. <i>Fusiturricula humerosa</i> (Gabb, 1873)
43. <i>Fusiturricula iole</i> Woodring, 1928
44. <i>Fusiturricula jaquensis</i> (Sowerby, 1850)
45. <i>Paraborsonia varicosa</i> (Sowerby, 1850)

---

In Appendix 2, I give a list of known large caenogastropod species from the Golfo de Triste and Golfo de Venezuela areas, this being gleaned from the pertinent literature and personal communications and observations. Of the 97 known species listed in this appendix, 19 species, *Siphocypraea donmoorei*, *S. mus*, *Calotrophon velero*, *Phyllonotus margaritensis*, *Murex donmoorei*, *Mazatlaniana aciculata*, *Strombina pumilio*, *Fusinus closter*, *Ancilla glabrata*, *A. tankervillei*, *Oliva oblonga*, *Olivella perplexa*, *Persicula tessellata*, *Prunum glans*, *P. pulchrum*, *Conus optabilis*, *C. undatus*, *Clathrodrillia gibbosa*, and *Hindsiclava chazaliei*, are restricted to northern South America, and in particular, the Colombian-Venezuelan coasts. When the 45 additional relicts given in the systematic section are added to this species list, it can be seen that roughly 46% of the large caenogastropods are Neogene relicts confined to the soft bottom community of the upwelling areas. This percentage would be even larger if the allopatric intertidal components, such as the littorinids and thaidids, were removed.

The survival of the relict pocket into the Recent as an intact entity is probably a function of the substrate and hydrographic conditions that are unique to northern South America. As shown by Meyer (1977: 45–71), this area is influenced by four continuous wind-driven upwelling systems (Fig. 130) and contains cold, atypical Caribbean water. The substrate of the Gulf of Venezuela area is also atypical for the continental Caribbean, containing large amounts of coarse quartz sands (Schuchert, 1935: 652–653) and turbid water conditions due to erosion of the Pleistocene fluviially deposited coastline (Petuch, 1979: 221). The Peninsulas of the Guajira and Paraguaná, together the center of distribution of the relict fauna, are desert areas with little or no river input and few mangrove environments. Nutrient enrichment of coastal waters of this area, therefore, derives from the upwellings and not from terrigenous input.

The cold, turbid water and non-reef environment of the northern South American coast most probably acts as a physiological and ecological barrier to typical tropical Caribbean molluscivorous predators. This possible predation barrier may explain why such extremely thin-shelled relict species as *Turritella paraguanensis*, *Natica stenopa*, *Siphocypraea mus*, *Siphocypraea henekeni*, *Ficus pilsbryi*, *Ancilla venezuelana*, *Oliva schep-*

*mani*, *Agatrix epomis* and *Strioterebrum ischna*, can exist in abundance in shallow water within this region (Petuch, 1976: 322–325) but are not found elsewhere in the Caribbean area.

Extrapolating backwards through time, the atypical Caribbean environment of the Recent northern South American coast probably approximates what had been the typical shallow water marine environment of much of the Neogene southern Caribbean. This hypothesis seems defensible when considering that the fauna of the relict assemblage had once been widespread throughout the southern Caribbean, but is now found only in the geographically small area of the upwelling systems. Where tropical waters and carbonate substrate environments now predominate in the southern Caribbean, the Neogene fauna is extinct and replaced by a widespread post-Pleistocene-Holocene fauna. On the other hand, where the environment comprises turbid, nutrient-rich water with temperatures below 25°C and a substrate of silicoclastic sediments, a typical Neogene southern Caribbean gastropod assemblage is still extant (Vermeij, 1978: 231–236).

The northern South American Neogene environment and its accompanying relict fauna is geographically well-defined. In the west, the carbonate and coral reef environment of the San Blas Islands, Panamá, acts as an effective barrier to the Neogene shallow water relicts. In the east, the extensive brackish water estuary at the mouth of the Orinoco River also acts as an effective barrier, limiting most of the relict forms. Only *Fusiturricula jaquensis* and possibly *Sconsia laevigata* (as *S. nephele*) have been reported from outside these geographical and physiological boundaries. Offshore islands, such as the Netherlands Antilles, Las Aves, and Los Roques, all have extensive coral reef growth, lack continuous upwelling systems, and contain a more typical Caribbean-West Indian gastropod fauna. No Neogene relicts have yet been reported from any of these island groups or their associated carbonate environments.

Philosophically, the relict pocket poses an interesting question; how can the ancestors of a group of animals still exist and retain an intact community structure while being surrounded, contemporaneously, by communities made up of their descendants? This can be clearly seen by the following species pairs—one being the supposed direct ancestor now found only in the communities com-

prising the relict pocket, and the other being the wide-ranging Caribbean descendant; *Morum dominguense*-*Morum dennisoni*, *Sconsia laevigata*-*Sconsia striata*, *Latirus anapetes*-*Latirus angulatus*, *Oliva schepmani*-*Oliva reticularis*, *Lyria limata*-*Lyria beai*, *Conus consobrinus*-*Conus cedonulli*, *Conus planiliratus*-*Conus attractus*, and *Hindsiclava consors*-*Hindsiclava alesidota*. These mollusks occur contemporaneously, although allopatrically, within the same faunal province.

In summary, evolution has been greatly slowed in the gastropod fauna found along northern Colombia and Venezuela. Conversely, faunas in other areas of the Caribbean have undergone extremely rapid speciation since the beginning of the Pleistocene. The concept of a heterochronous Caribbean Province implies several modes of provincial differentiation and development. The homochronous sister Panamic Province probably represents an area of more evenly distributed evolutionary pressures, with a nearly homogeneous fauna within its boundaries. The Caribbean, on the other hand, represents an area that was exposed to differential speciation and extinction pressures. This has manifested itself along the northern South American coast as an intact but spatially reduced Neogene relict pocket surrounded by a large cortex of post-Pleistocene-derived species.

## SYSTEMATIC SECTION

### Descriptions of Neogene relict Caenogastropods

As briefly outlined in the literature section, the first detailed analysis and discussion of the Gatunian relict pocket was done by J. Gibson-Smith & W. Gibson-Smith in 1979. They recognized two Pliocene archaeogastropods, *Tegula puntagordana* Weisbord, 1962 and *Parviturbo venezuelensis* Weisbord, 1962 as extant along the Venezuelan coast. In their discussion of Weisbord's Pliocene caenogastropod taxa (1979: 24, 26), the Gibson-Smiths recognized two more extant species, *Fasciolaria hollisteri* Weisbord, 1962 (*F. tulipa* Linnaeus, 1758 variety?) and *Oliva schepmani* Weisbord, 1962. They synonymized three others as forms of Recent species; *Fusinus caboblanquensis* Weisbord, 1962 as a form of *F. closter* (Philippi, 1851),

*Ancilla venezuelana* Weisbord, 1962 as *A. tankervillei* (Swainson, 1825), and *Persicula hodsoni* Weisbord, 1962 as *P. interruptolineata* (Megerle von Mühlfeld, 1816). I recognize the last three taxa of Weisbord as valid relict species. These, along with *Oliva schepmani*, *Crucibulum mareense*, *Strombina caboblanquensis*, *Fusinus marensis*, *Strioterebrum quadrispiralis*, and *S. trispiralis*, bring to a total of twelve the number of fossil gastropods described by Weisbord that can be shown to be extant.

Besides the five relict caenogastropods discussed by the Gibson-Smiths, two other relicts have been reported in the recent literature. These are *Agatrix epomis* (Woodring, 1928), shown to be extant along Venezuela by Petit (1976), and *Fusiturricula jaquensis* (Sowerby, 1850), recognized as still living off Surinam by Abbott (1974). This last relict was described as a new species of *Knefastia* (a genus not found in the western Atlantic) by Princz (1980: 70-72). A number of other well-known northern South American caenogastropods, all described from Recent specimens, were also shown by Weisbord (1962) to have existed in the Venezuelan Pliocene assemblages, and as such, constitute relict species. These include *Siphocypraea donmoorei* Petuch, 1979 (as *S. henekeni* variety), *Murex donmoorei* Bullis, 1960 (as *M. recurvirostris*), *Calotrophon velero* (E. Vokes, 1970) (as "*Latirus*" *recticanalis*), *Ancilla tankervillei* (Swainson, 1825), *Mazatlanina aciculata* (Lamarck, 1822), *Conus puncticulatus* Hwass, 1792 (as *C. jaspideus caboblanquensis*), and *Clathrodrillia gibbosa* (Born, 1778). As shown by myself (1979), Bayer (1971), E. Vokes (1970), and Vermeij (1978: 231-235), these species are restricted to the northern coast of South America and fall within the ranges of the other known relict species.

Adding to the preliminary works of Weisbord and the Gibson-Smiths, I herein redescribe several more previously unknown Neogene relict species.

### Family Turritellidae Genus *Turritella* Lamarck, 1799

1. *Turritella paraguayensis* Hodson, 1926  
Figs. 1-2

*Turritella variegata paraguayensis* Hodson, 1926: 31, pl. 21, figs. 2, 7.



FIGS. 1-13. 1-2. *Turritella paraganensis* Hodson: USNM 784451, L = 81 mm. 3-4. *Turritella variegata* (Linnaeus): P-712, L = 78 mm. 5-6. *Crucibulum mareense* Weisbord: USNM 784452, L = 16 mm. 6a. *Crucibulum mareense* attached to *Polystira barretti* shell. 7-9. *Crucibulum springvaleense* Rutsch: P-712, L = 18 mm. 10-11. *Natica stenopa* Woodring: USNM 784570, L = 29 mm. 12-13. *Siphocypraea mus* (Linnaeus): UMML 8278, L = 31 mm.

*Turritella maiquetiana* Weisbord, 1962: 146–150, pl. 11, figs. 1–16.

*Material examined*—5 specimens, lengths 75–85 mm, exposed at low tide, Amuay Bay, Paraguaná Peninsula, Estado Falcón, Venezuela, 21 March 1979, UMML 8276; 7 specimens, lengths 80–96 mm, same locality and date, USNM 784451.

*Major citations*—Redescribed in detail, with diagnosis, by Weisbord, 1962 (as *T. maiquetiana* n.sp.).

*Additions to original description*—Shell surface smooth, slightly shiny, with a silky texture; color variable, usually gray or bluish-gray with numerous fine revolving lines of black dots; some specimens deep blue-black; base color overlaid with intermittent vertical flammules of dark gray or black; dark specimens frequently with white or pale gray vertical flammules alternating with dark flammules.

*Remarks*—Although originally described as a subspecies of the Recent *T. variegata* (Linnaeus, 1758), *T. paraganensis* is also a well-known member of Plio-Pleistocene assemblages throughout Venezuela (Weisbord, 1962: 146–147). Weisbord described (as *T. maiquetiana*) fossil specimens of *T. paraganensis* from the Pliocene beds of the Playa Grande and Lower Mare formations. This description is important because of the emphasis on the form and structure of the early whorls and their use in separating *T. paraganensis* from other known species.

*Turritella paraganensis* belongs to a long and species-rich lineage that originated with the lower Miocene Venezuelan *T. berjadinensis* (Hodson, 1926, pl. 20, fig. 5) and the Miocene Colombian *T. cartagenensis* Pilsbry and Brown, 1917. In the Recent fauna, *T. paraganensis* most closely resembles *T. banksi* Reeve, 1849 and *T. gonostoma* Valenciennes, 1832 from the Panamic Province. *Turritella variegata* (Figs. 3–4) is the only Atlantic species that shows any relationship to *T. paraganensis*. The Venezuelan relict differs from *T. variegata* in being larger, by having a blue-gray ground color (like *T. gonostoma*), and by lacking the heavy spiral sculpturing of *T. variegata*. The shell outlines of the two species also differ consistently; that of *T. variegata* is straight-sided while *T. paraganensis* is distinctly turreted due to the characteristically deeply impressed suture.

*Fossil distribution*—Playa Grande and Cabo Blanco formations, Venezuela.

*Recent distribution*—At present, known only from the Golfo de Venezuela, in shallow bays.

Family Calyptraeidae

Genus *Crucibulum* Schumacher, 1817

2. *Crucibulum (Dispotaea) mareense*  
Weisbord, 1962  
Figs. 5–6a

*Crucibulum (Dispotaea) mareense* Weisbord, 1962: 218, pl. 20, figs. 10, 11.

*Material examined*—Length 16 mm, width 15 mm, height 12 mm, attached to a living *Polystira barretti* trawled from 35 m depth off Cabo La Vela, Peninsula de Guajira, Colombia (12°10'N, 72°15'W), December, 1974, USNM 784452.

*Additions to original description*—Shell waxy, smooth; color uniform pale yellow-orange; internal cup translucent white.

*Remarks*—*Crucibulum mareense* differs from most known Atlantic calyptraeids, both fossil and living, in having only a small portion of the margin of the internal cup adherent to the shell interior. In this respect, *C. mareense* most closely resembles the Recent *C. personatum* Keen, 1958 from the Panamic Province. *Crucibulum waltonense* Gardner, 1947 from the Alum Bluff series of Florida and *C. ecuadoreense* Olsson, 1932 from the Progreso formation of Ecuador are similar to *C. mareense* in having the internal cup adherent to the shell interior; but their attachments are larger, often including over half of the margin of the internal cup.

The single living specimen of *C. mareense* was found attached to the posterior columellar area, near the anal slit, of another relict species, *Polystira barretti* (Guppy, 1886). As can be seen in Fig. 5, the shell margin of *C. mareense* corresponds perfectly to the body whorl of the *Polystira*. Interestingly enough, the unusual horizontally-arranged primary sculpture of *C. mareense* also corresponds to the raised spiral cords on the body whorl of the turrid, and represents a xenomorphic growth pattern. Although the holotype of *C. mareense* lacks the raised horizontal ribs of the Recent Colombian specimen, the structure of the protoconch, the shape and form of the internal cup, and the dichotomous fine surface are identical in both specimens. The presence of raised horizontal ribs appears to

be a response to living on the heavily sculptured substrate of the turrid shell.

E. Vokes (in litt.) has suggested that this and the following species may actually be forms of *C. planum* Schumacher, a poorly-known and "lost" species. Until the systematics of this complex group is better known and since this shell is well-illustrated and described in Weisbord's paper, I prefer to use the taxon *C. mareense* for the Venezuelan fossil and living species.

*Fossil distribution*—Mare formation, Venezuela.

*Recent distribution*—Known only from 35 m depth off the Peninsula de Guajira, Colombia.

3. *Crucibulum (Dispotaea) springvaleense*  
Rutsch, 1942  
Figs. 7–9

*Crucibulum springvaleense* Rutsch, 1942: 138, pl. 4, fig. 8. Woodring, 1957: 83–84, pl. 19, figs. 8–10.

*Material examined*—Lengths 18 mm and 17 mm, P-712 (11°08'N, 63°18'W), 25 m depth.

*Major citations*—Redescribed in detail, with diagnosis, by Woodring, 1957.

*Additions to original description*—Shell color pale yellow-tan to yellow-white with radiating patches of reddish-brown dots and flammules; color pattern readily visible on both surfaces; internal cup translucent white, one-third adherent to shell interior; external surface with radiating raised ridges.

*Remarks*—The specimen illustrated here is most probably a juvenile, as it is indistinguishable from the early stages of the fossil illustrated by Woodring (1957, pl. 19, figs. 8, 9). *Crucibulum springvaleense* is similar to *C. mareense* but can be separated by having a larger internal cup attachment and a different color pattern. By having attached internal cups, both *C. mareense* and *C. springvaleense* differ from the other northern South American congener, *C. auricula* (Gmelin, 1791).

*Fossil distribution*—Springvale formation, Trinidad; Turberá formation, Colombia; Gatun formation, Costa Rica and Panamá.

*Recent distribution*—Known only from off the Venezuelan coast, at depths of around 25 m.

Family Naticidae

Genus *Natica* Scopoli, 1777

Subgenus *Naticarius* Duméril, 1805

4. *Natica stenopa* Woodring, 1957  
Figs. 10–11

*Natica (Naticarius) stenopa* Woodring, 1957: 85–86, pl. 20, figs. 4–6.

*Material examined*—Lengths 29 mm and 20 mm, trawled by commercial shrimp boats from 35 m depth in Golfo de Triste, Venezuela (11°42'N, 69°22.5'W), March, 1979, USNM 784570.

*Additions to original description*—Shell pale cream-gray becoming gray on spire; margin of suture white; interior of aperture white with wide pale brown band.

*Remarks*—Although somewhat larger than the fossil specimens illustrated by Woodring, the two Recent specimens agree quite closely with the illustrations of Woodring's types. The specimen shown here has the characteristic spire sculpture consisting of short, retractive axial grooves that extend from the suture onto the shoulder of later whorls.

*Fossil distribution*—Gatun formation, Panamá.

*Recent distribution*—35 m depth in Golfo de Triste, Venezuela.

Family Cypraeidae

Genus *Siphocypraea* Heilprin, 1886

The *Siphocypraea henekeni* species complex

The Tertiary South American and West Indian *Siphocypraea* species complex has been one of the more controversial groups in Caribbean paleontological studies. As abundant indicator organisms, members of the genus are well-documented in the literature. During the last several decades, two different approaches have been taken by fossil cypraeid workers, leading to two schools of thought on speciation within the complex and treatment of specific morphological characters. One group, principally Maury (1925) Schilder (1939), and Ingram (1939, 1940, 1947a, b), described several new species of what appeared to be a close-knit complex centered around the widespread *Siphocypraea henekeni* (Sowerby, 1850). These taxa were erected on what some workers



consider trivial, although consistent characters. The second group, including Woodring (1959), Pflug (1961), and Weisbord (1962), has argued that the species of Maury, Schilder, Ingram and others are to be considered intraspecific variants, or at best population variants, of a morphologically plastic *S. henekeni*.

Until 1979, only a single living species of the *S. henekeni* lineage, *S. mus* (Linnaeus, 1758), was known to exist. In that year, I described a second living species, *S. donmoorei*, from off the coasts of Colombia and Venezuela. It is now recognized that *S. donmoorei* is also present in the fossil record, as demonstrated by the specimen illustrated by Weisbord (1962, pl. 22, figs. 5, 6, as "*S. henekeni*"). In March of 1979, five specimens of another species of *Siphocypraea* were taken from off the Venezuelan coast. The anatomy of this *Siphocypraea* differed from the anatomies of the other two living species. The shell morphology of this third species compared very closely with specimens of *S. henekeni* illustrated by Woodring (1959, pl. 32, figs. 1, 4, 6, 9). It is now apparent that there are, in fact, three living species of *Siphocypraea*, with the five Venezuelan shells being representative of an extant population of the previously ubiquitous *S. henekeni*.

When the shell morphologies of *S. mus*, *S. donmoorei*, and *S. henekeni* are compared, no striking differences can be observed; this morphological conservatism is the principal reason why the shells of the three species had been confused for so long. When the living animals are compared, the three species can be easily separated. *Siphocypraea henekeni* has a uniformly bright orange-red animal, with long, unbranched mantle papillae (Fig. 129). The animal of *S. donmoorei* is white with only a few scattered patches of gray, while the mantle papillae are elongate and dendritic (Fig. 128). The gray and black-mottled *S. mus* has very reduced, wart-like papillae, these often being white or pale orange (Fig. 127).

Considering that the three extant *Siphocypraea* species have similar-looking shells but different animals, one has to view the supposed variants of *S. henekeni* in a different light. In all probability, the consistent morphologies seen in many of the fossil forms, such as the thickened dorsal callus of *S. lacrimula* (Maury, 1925) and the elongate

and flaring beaks of *S. projecta* (Ingram, 1947), represent full species characteristics and not merely variations within a single gene pool. Based on the biological evidence seen in the living species, I prefer to treat the taxa of Maury, Ingram, Schilder, etc., as full species and not as synonyms of *S. henekeni*. The anatomy and ecology of the well-known *S. mus* was outlined by Petuch (1979: 217–220). Since *S. donmoorei* is also a relict, it is included here to facilitate a comparison with the other two living species of *Siphocypraea*.

*Siphocypraea donmoorei* Petuch, 1979  
Figs. 18–21

*Cypraea (Muracypraea) henekeni*, Weisbord, 1962 (non *C. henekeni* Sowerby, 1850), 236–238, pl. 22, figs. 5, 6.

*Siphocypraea donmoorei* Petuch, 1979: 216–225, pl. 1, figs. D-I.

*Material examined*—Holotype, USNM 770731, length 64 mm, 37 m depth off Cabo La Vela, Colombia (12°10'N, 72°15'W); length 55 mm, 39 m depth off Cartagena, Colombia (10°22'N, 75°47'W), UMML 8162; length 59 mm, 40 m depth in Golfo de Urabá, Colombia (8°38'N, 77°2'W), UMML 8161; length 55 mm, 30 m depth off Cartagena, Colombia, USNM 770732; length 60 mm, 37 m depth off Cabo La Vela, Colombia, USNM 784453.

*Major citations*—Detailed description of fossil specimens given by Weisbord, 1962 (as *C. henekeni* variety); living specimens described by Petuch, 1979.

*Remarks*—Morphologically, the shells of *S. donmoorei* and *S. henekeni* appear similar. The animals of the two species are, however, very different (as illustrated here). Upon closer examination, the shells of the two species do show some consistent differences, and these can be used in separating mixed lots of shells without the animals. The shell of *S. donmoorei* is larger than that of *S. henekeni* (67–75 mm average length as opposed to the 40–50 mm average length of *S. henekeni*), darker in color, and has a uniformly narrow, arcuate aperture. The labial and columellar dentition of *S. donmoorei* are coarser and more developed, but less numerous than the dentition of *S. henekeni*.

I had previously stated (Petuch, 1979: 224) that the cypraeid illustrated by Weisbord (1962, pl. 22, figs. 5, 6) probably represented

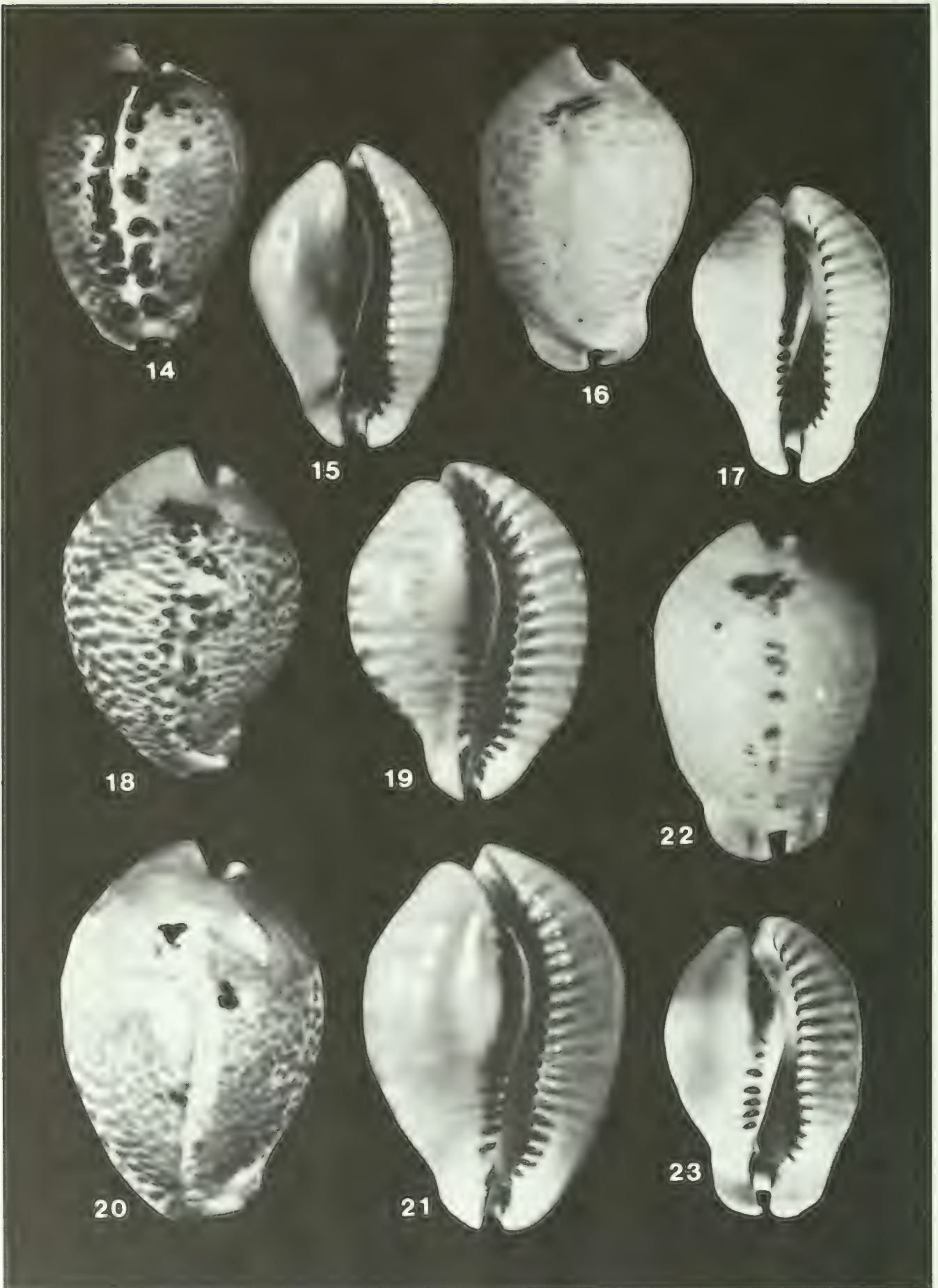

FIGS. 14-23. 14-15. *Siphocypraea mus* (Linnaeus): USNM 784454, L = 50 mm. 16-17. *Siphocypraea henekeni* (Sowerby): USNM 784455, L = 48 mm. 18-19. *Siphocypraea donmoorei* Petuch: USNM 770732, L = 55 mm. 20-21. *Siphocypraea donmoorei* Petuch (holotype): USNM 770731, L = 60 mm. 22-23. *Siphocypraea henekeni* (Sowerby): USNM 784455, L = 46 mm.

the ancestor of both *S. mus* and *S. donmoorei*. In March, 1979, I had the opportunity to study several similar specimens, taken from the same fossil deposits of Weisbord's, in the Gibson-Smith collection, Caracas, Venezuela. These fossil specimens are identical to living specimens of *S. donmoorei* taken from off the Guajira Peninsula of Colombia. Geologically, *S. donmoorei* is now known to range from the middle Pliocene to the Recent. The closely-related *S. mus* most probably represents a Pleistocene offshoot of the wide-ranging *S. donmoorei*; having become adapted to the *Thalassia*-based ecosystem of the Golfo de Venezuela region.

*Fossil distribution*—Mare and Playa Grande formations, Venezuela.

*Recent distribution*—Golfo de Urabá, along the Colombian coast and Peninsula de Guajira, into the Golfo de Venezuela off the Peninsula de Paraguaná, Venezuela, in depth ranging from 15–50 m.

5. *Siphocypraea henekeni* (Sowerby, 1850)  
Figs. 16–17, 22–23

*Cypraea henekeri* Sowerby, 1850: 45, pl. 9, fig. 3.

*Cypraea henekeni* Gabb, 1873: 235. Emendation for *C. henekeri* Sowerby. Woodring, 1959: 194–196, pl. 31, figs. 6–10, pl. 32, figs. 1, 4, 6, 9. Pflug, 1961: 30–32. Petuch, 1979: 216–217, table 1. With discussion of Gabb's emendation.

*Material examined*—Lengths 48 mm and 46 mm, from 20 m depth in Golfo de Triste, Venezuela (11°42'N, 69°40'W), March, 1979, USNM 784455; length 37 mm, from 25 m depth off Punto Fijo, Golfo de Venezuela, Venezuela (11°52', 70°22'W), March, 1979, USNM 784456; lengths 42 mm and 38 mm, from 20 m depth in Golfo de Venezuela, UMML 8277; preserved animals in mollusk collection of INTECMAR, Universidad Simón Bolívar, Caracas, Venezuela.

*Major citations*—Redescribed in detail, with synonymies, by Woodring, 1959 and Pflug, 1961.

*Additions to original description*—Color of dorsum pale bluish-white to light blue with numerous pale tan spots; spots distinctly separate and not coalescing; some specimens with pale brown bar-shaped markings along sides and dark brown or black patch on posterior and near apex; base of shell flattened, varying in color from dark tan to dark

brown; pale dorsum color and dark base color meeting along flattened lateral margin; columellar and labial teeth dark chocolate brown; interior of aperture pale tan to yellow; dorsum of adult specimens with deeply incised central sulcus running from apex to anterior tip; beaks of adult specimens characteristically flaring, ear-like, greatly extended; living animal uniformly orange-red with elongate, simple mantle papillae.

*Remarks*—A comparison between the shell morphologies of *S. donmoorei* and *S. henekeni* is outlined in the previous species description. *Siphocypraea henekeni* differs from *S. mus* not only in coloration of the living animals and the structure of the mantle papillae but also in shell morphology. *Siphocypraea mus* has a darkly colored, inflated shell with weak labial dentition and poorly developed (and often absent) columellar dentition. The oddly-flattened, pale-colored shell of *S. henekeni* is in direct contrast, with the columellar dentition well developed and the labial dentition coarser and more numerous. Of the living *Siphocypraea*, the enlarged, flange-like beaks are unique to *S. henekeni*.

*Fossil distribution*—Bowden formation, Jamaica; Gurabo formation, Santo Domingo; Springvale formation, Trinidad; Cantaure and Punta Gavilán formations, Venezuela; Gatun formation, Panamá; Esmeralda formation, Ecuador; Gatun formation, Costa Rica.

*Recent distribution*—From Golfo de Venezuela to Golfo de Triste, Venezuela, at depths of 20–30 m.

Family Cassidae

Genus *Morum* Röding, 1798

6. *Morum (Oniscidia) dominguense* (Sowerby, 1850)  
Figs. 24–25

*Oniscia dominguensis* Sowerby, 1850: 47, pl. 10, fig. 3.

*Morum dominguense*, Pilsbry, 1922: 363. Pflug, 1961: 37–38, pl. 7, figs. 9–12, pl. 8, figs. 1, 2, 5–7.

*Morum dennisoni* Bayer, 1971 (non Reeve, 1843): 140, fig. 16, lower two figures.

*Material examined*—Length 35 mm, P-772 (12°20.2'N, 71°55.1'W), 11 m depth.

*Major citations*—Redescribed in detail by Pflug, 1961, with illustration of lectotype (pl. 8, figs. 6, 7).

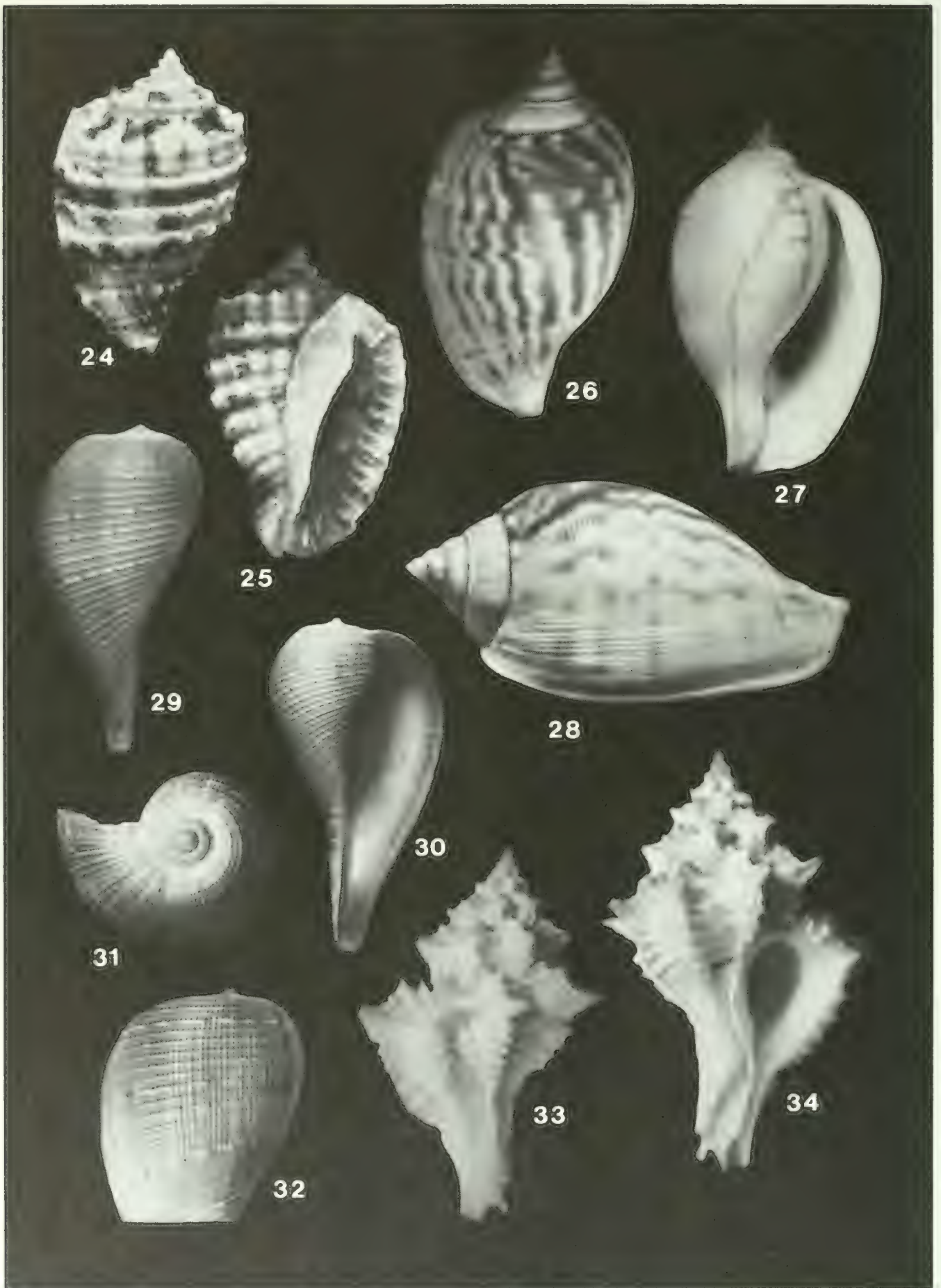

FIGS. 24-34. 24-25. *Morum dominguense* (Sowerby): P-772, L = 35 mm. 26-28. *Sconsia laevigata* (Sowerby): USNM 784457, L = 71 mm. 29-31. *Ficus pilsbryi* (B. Smith): USNM 784458, L = 76 mm. 32. *Ficus pilsbryi*, same specimen, showing detail of body whorl sculpture. 33-34. *Panamurex gatunensis* (Brown & Pilsbry): USNM 784571, L = 26 mm.

*Additions to original descriptions*—Shell color pinkish-white with scattered patches of bright pink; body whorl with two reddish-brown bands; spire with intermittent large reddish-brown patches; parietal shield salmon-pink with lavender border and white pustules; outer lip salmon-pink with numerous lavender-purple radiating bars; teeth of outer lip salmon-pink; interior of aperture white; protoconch and early whorls white.

*Remarks*—Bayer (1971, fig. 16, lower two figures) illustrated this species but considered it a variety of *Morum dennisoni* (Reeve). *Morum dominguense* differs from that species, however, in having a broader, tabulate spire, by having a smaller and less developed parietal shield, and by having larger and more developed labial teeth. The two species can also be differentiated by the colors of the parietal shields; *M. dennisoni* has a bright red-orange shield, while that of *M. dominguense* is a rich salmon-pink with lavender shadings.

Although the single known Recent specimen closely resembles the fossil illustrated by Pflug (pl. 8, figs. 1, 2) in both shape and sculpturing, it differs in having more varices per whorl (12 in the fossil, 16 in the Recent specimen). Otherwise, the fossil and living forms are virtually indistinguishable.

*Fossil distribution*—Gurabo formation, Santo Domingo; Bowden formation, Jamaica; Gatun formation of Costa Rica and Panamá.

*Recent distribution*—Known only from off the Peninsula de Guajira, Colombia, 11 m depth.

#### Genus *Sconsia* Gray, 1847

##### 7. *Sconsia laevigata* (Sowerby, 1850) Figs. 26–28

*Cassidaria laevigata* Sowerby, 1850: 47, pl. 10, fig. 2.

*Sconsia laevigata*, Maury, 1917: 275, pl. 19, fig. 2. Woodring, 1928: 309–310. Woodring, 1959: 201–202. Pflug, 1961: 36–37, pl. 7, figs. 1–8.

*Sconsia striata* Bayer, 1971 (non Lamarck, 1816): fig. 14, lower two figures.

*Material examined*—Length 71 mm, trawled by commercial shrimp boat, from 35 m depth off Cartagena, Colombia, December, 1976, USNM 784457; length 43 mm, P-353 (8°13.2'N, 76.5°0.1'W), 25 m

depth; lengths 49 mm and 51 mm, P-361 (8°52'N, 76°37'W), 37 m depth; length 62 mm, P-362 (8°57'N, 76°34'W), 60 m depth; length 24 mm, P-367 (9°31'N, 75°50'W), 36 m depth; length 52 mm, P-756 (11°33.1'N, 69°12.6'W), 25 m depth; length 32 mm, P-760 (12°15.4'N, 69°57.5'W), 62 m depth.

*Major citations*—Redescribed by Pflug, 1961, with illustrations of the lectotype and a representative series (pl. 7, figs. 1–8).

*Additions to original description*—Shell color white with variable amount of red-brown mottling, usually in form of vertical flammules in zebra-like pattern; color pattern may vary from pure white to having 4–6 rows of brown checkers or alternating vertical flammules composed of coalesced checkered bands (as in Bayer, 1971: fig. 14, lower two figures); spire white, often with band of brown flammules; interior of aperture white; outer lip well developed, thickened; porcelaneous white.

*Remarks*—Bayer (1971, fig. 14, lower two specimens) illustrated a Recent specimen of *Sconsia laevigata* (P-353) but misidentified it as a variant of *S. striata*. *Sconsia laevigata* is a common species in offshore Colombian and Venezuelan waters and is morphologically consistent; a large series from all along this area shows little variation in form and color pattern. This consistency is also seen in the fossil record.

The Recent specimen illustrated here is identical to the fossil illustrated by Pflug (1961, pl. 7, figs. 1–4, 6). The characteristic cancellate sculpture on the outer lip of the fossil, a feature well-illustrated by Pflug (fig. 6), is the same as that of the Recent specimen (Fig. 28). The morphologically very similar *S. nephele* Bayer, 1971 from 18 m depth off Grenada may possibly be only a color morph of *S. laevigata*. This is substantiated by the fact that several of the specimens collected (P-363, P-760, P-362) had patterns composed of bands of alternating light and dark blocks which, in turn, were overlaid by a pattern of vertical flammules. These specimens act as intergrades between the zebra color morph illustrated here and the checkered *S. nephele*. E. Vokes (in litt.) has stated that a fossil specimen of *S. laevigata* examined by her under ultraviolet light revealed a color pattern like that of *S. nephele* or like that of the P-760 specimen of *S. laevigata*.

*Fossil distribution*—Bowden formation, Jamaica; Gurabo formation, Santo Domingo;

Gatun formation, Costa Rica and Panamá; Esmeraldas formation, Ecuador.

*Recent distribution*—From Golfo de Urabá, Colombia, along Colombian coast, into the Golfo de Venezuela, and to at least Isla Margarita, Venezuela, at depths of 15–16 m.

Family Ficidae  
Genus *Ficus* Röding, 1798

8. *Ficus pilsbryi* (B. Smith, 1907)  
Figs. 29–32

*Pyrula pilsbryi* B. Smith, 1907: 213–214, fig. 1. Maury, 1917: 277.

*Ficus pilsbryi*, Woodring, 1928: 313–314, pl. 20, fig. 9, pl. 21, figs. 1, 2.

*Material examined*—Lengths 82 mm, 76 mm, and 71 mm, trawled by commercial shrimp boats from 15 m depth off Punto Fijo, Golfo de Venezuela, March, 1979, USNM 784458; length 29 mm, P-709 (11°24.7'N, 62°40.5'W), 46 m depth; length 74 mm, P-712 (11°08.0'N, 63°18.0'W), 25 m depth; lengths 73 mm and 54 mm, P-767 (12°16.1'N, 71°03.3'W), 25 m depth; length 31 mm, P-772 (12°20.2'N, 71°55.1'W), 11 m depth.

*Major citations*—Redescribed, with diagnosis, by Woodring, 1928.

*Additions to original description*—Shell sculpture cancellate, consisting of strong primary spiral threads and one weak secondary thread between each pair of primary spiral threads; spiral sculpture intersected by strong axial threads equal to primary spiral threads (Fig. 32); color dark brownish-tan with scattered wide vertical bands of darker brown; strong axial threads with alternating white and brown dashes; weak secondary axial threads uniformly dark tan; spire white with white callus over last whorl; protoconch white; interior of aperture tan turning white towards lip.

*Remarks*—This is the first shallow water *Ficus* reported from the Recent southern Caribbean. Although *F. pilsbryi* bears some resemblance to the Carolinian *F. communis* (Say), the relic's brown color and characteristic cancellate sculpture make it readily separable from the Carolinian species.

The sculpture of the fossil specimen illustrated by Woodring (1928, pl. 20, fig. 9) is identical to that of the Recent Venezuelan specimens.

*Fossil distribution*—Bowden formation, Jamaica; Gurabo formation, Santo Domingo.

*Recent distribution*—Peninsula de Guajira, Colombia, into the Golfo de Venezuela, and to the Golfo de Triste, Venezuela, at depths of around 10–35 m.

Family Muricidae  
Subfamily Muricinae Rafinesque, 1815  
Genus *Panamurex* Woodring, 1959

9. *Panamurex gatunensis*  
(Brown & Pilsbry, 1911)  
Figs. 33–34

*Murex (Phyllonotus) gatunensis* Brown & Pilsbry, 1911: 354, pl. 26, fig. 2.

*Paziella (Panamurex) gatunensis*, Woodring, 1959: 217–218, pl. 35, figs. 6, 7, 10.

*Material examined*—Length 26 mm, trawled by commercial shrimp boats from 35 m depth in Golfo de Triste, Venezuela, November, 1977, USNM 784571.

*Major citations*—Redescribed in detail, with diagnosis and illustrations, by Woodring, 1959.

*Additions to original description*—Shell pure white, covered with a white chalky intritacalx.

*Remarks*—The single Recent specimen of *P. gatunensis* is very similar to the specimens figured by Woodring both in size and shell sculpture. Although also placed in *Panamurex* by E. Vokes (1971: 114), the sympatric Colombian-Venezuelan *Calotrophon velero* (Vokes, 1970) was shown not to belong to Woodring's genus by Radwin & D'Attilio (1976: 31–32). *Panamurex gatunensis*, therefore, is the first and only known living member of this once widespread group of muricids.

E. Vokes (in litt.) has suggested that my specimen represents a new species that is very close to *P. gatunensis*. The living Venezuelan specimen shown here, however, is identical in every way to a Gatun formation fossil specimen in the Vermeij collection at the University of Maryland. Since my living specimen is identical to the Panamanian fossil, in size, aperture shape, and having varical flanges, and since the morphological variation of the populations of *P. gatunensis*, both living and fossil, is not known, I prefer to retain the taxon *P. gatunensis* for the single living Venezuelan specimen.

*Fossil distribution*—Gatun formation, Panamá; Tuberá formation, Colombia.

*Recent distribution*—35 m depth in Golfo de Triste, Venezuela.

Family Columbelloidea

Genus *Strombina* Mörch, 1852

10. *Strombina caboblanquensis*

Weisbord, 1962

Figs. 35–36

*Strombina caboblanquensis* Weisbord, 1962: 323–327, pl. 28, figs. 25–30, pl. 29, figs. 1–4. Gibson-Smith & Gibson-Smith, 1974: 24.

*Material examined*—7 specimens, lengths 15–20 mm, P-712 (11°08'N, 63°18'W), 25 m depth; 5 specimens, lengths 13–16 mm, P-721 (11°06.5'N, 64°22.5'W), 26 m depth; lengths 19 mm and 20 mm, trawled by commercial shrimp boat, 20 m depth in Golfo de Triste, Venezuela (11°42'N, 69°22.5'W), March 1979, USNM 784459.

*Major citations*—Expanded diagnosis given by J. Gibson-Smith & W. Gibson-Smith, 1974.

*Additions to original description*—Shell shiny, waxy; color bright yellow-ochre with scattered irregular white flammules; outer lip pure white; aperture and labial callus pure white; columellar callus yellow.

*Remarks*—As outlined by Weisbord (1962: 326) and Gibson-Smith & Gibson-Smith (1974: 53–54), *S. caboblanquensis* can be easily separated from its congener, *S. pumilio* (Reeve, 1859) (Figs. 37–38). The Recent Caribbean *S. pumilio* differs from *S. caboblanquensis* in being a broader, less turreted shell, with a lower spire and with the outer lip more developed and flaring. *Strombina caboblanquensis* has more and finer varices than does *S. pumilio*, a character that shows up well in Figs. 35 and 36. Although *S. pumilio* also has a diamond criss-cross pattern of lines on the body whorl, these are wider apart and are not as developed nor as deeply incised as those of *S. caboblanquensis*.

*Strombina pumilio* was previously thought to have been the only living Atlantic *Strombina*. In 1974, however, Gibson-Smith & Gibson-Smith described the second known living species, *S. francesae*, from Los Roques Islands, Venezuela. *Strombina cabo-*

*blanquensis*, although described as a fossil, has now been found to be extant along the Venezuelan coast, and represents the third living Atlantic *Strombina*. A possible fourth Atlantic species is presented here in the following description.

*Fossil distribution*—Mare formation and Maiquetia member of the Playa Grande formation, Venezuela.

*Recent distribution*—From the Peninsula de Paraguaná to the Golfo de Triste region, Venezuela, at depths of 15–40 m.

11. *Strombina* sp.

Figs. 39–40

*Material examined*—Length 15 mm, trawled by commercial shrimp boats from 35 m depth in Golfo de Triste, Venezuela, March, 1979, USNM 784572.

*Description*—Shell with 6 whorls, smooth, waxy; body whorl broad, laterally flattened; spire roughly ½ total shell length; body whorl with 10 evenly-spaced sharp-edged axial ribs; spire whorls with 10–12 ribs; color white with large yellow patch on dorsum and near aperture; spire and protoconch yellow; outer lip and labial dentition white; diamond criss-cross sculpture reduced, absent on axial ribs.

*Remarks*—This small *Strombina* most probably represents an undescribed species, sympatric with both *S. pumilio* and *S. caboblanquensis*. I have included it here in order to show that the *Strombina* fauna of northern South America is actually larger than was originally assumed. Of the four known Atlantic species of *Strombina*, the new species is the smallest. It differs from the two mainland species in being squatter, having evenly-spaced smooth axial ribs over the entire dorsum, and in lacking the prominent dorsal hump seen in both *S. pumilio* and *S. caboblanquensis*.

Family Buccinidae

Genus *Antillophos* Woodring, 1928

12. *Antillophos elegans* (Guppy, 1866)

Figs. 43–44

*Phos elegans* Guppy, 1866: 290, pl. 16, fig.

13. Maury, 1917: 250–251, pl. 40, fig. 10.

Olsson, 1942: 88.

*Tritiaria (Antillophos) elegans*, Woodring, 1928: 262, pl. 16, fig. 1.

*Antillophos elegans*, Pflug, 1961: 46–47, pl. 11, figs. 1–3, 9, 10, 14, 16–19.

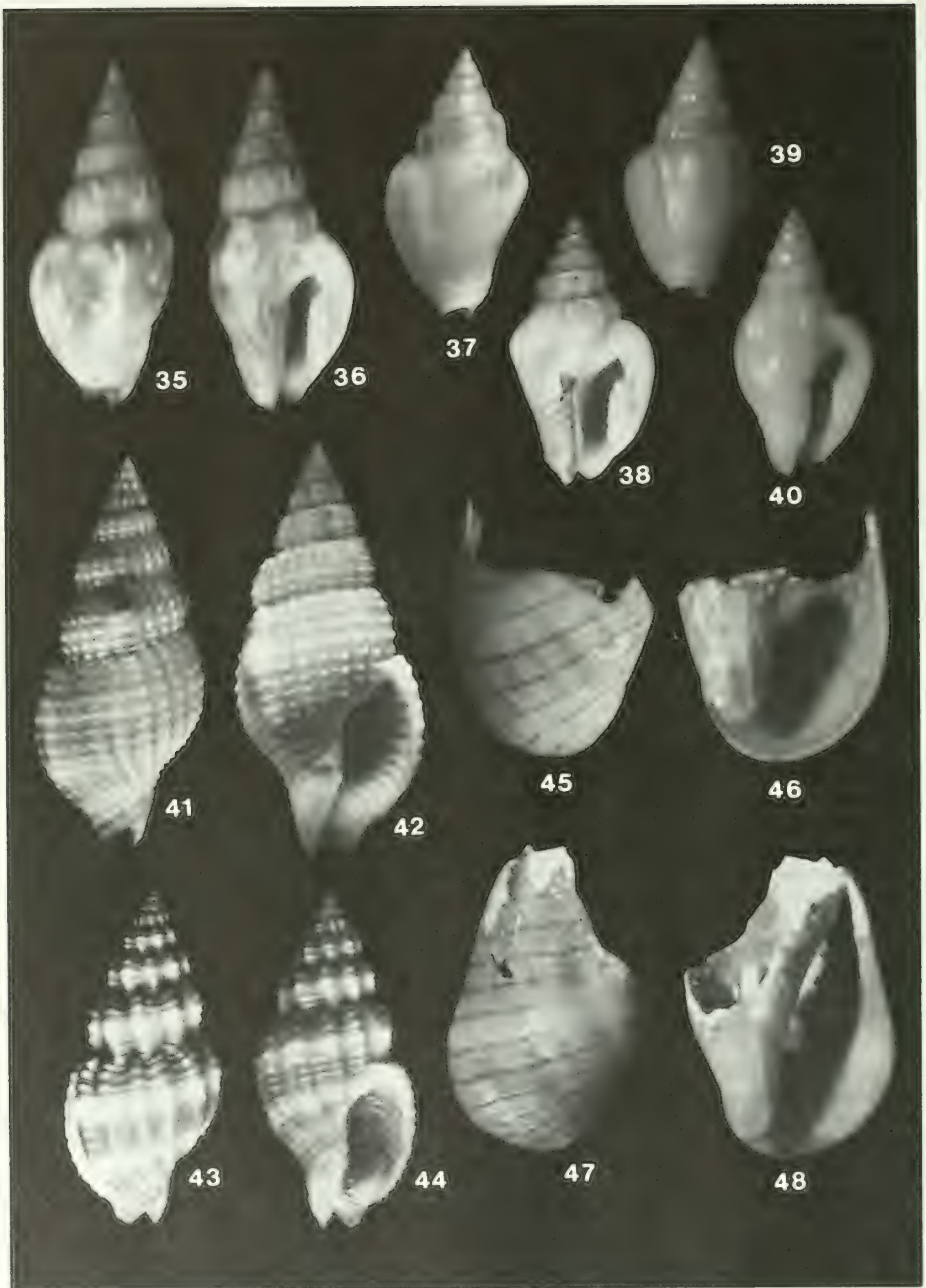

FIGS. 35-48. 35-36. *Strombina caboblanquensis* Weisbord: USNM 784459, L = 20 mm. 37-38. *Strombina pumilio* (Reeve): P-712, L = 16 mm. 39-40. *Strombina* sp.: USNM 784572, L = 15 mm. 41-42. *Antillophos candei* (d'Orbigny): P-712, L = 27 mm. 43-44. *Antillophos elegans* (Guppy): USNM 784460, L = 20 mm. 45-46. *Truncaria* sp.: P-734, fragment L = 22 mm. 47-48. *Truncaria* sp.: P-734, fragment L = 20 mm.



*Material examined*—Lengths 20 mm and 15 mm, trawled by commercial shrimp boats, from 35 m depth, Golfo de Triste, Venezuela, March, 1979, USNM 784460.

*Major citations*—Holotype and representative series illustrated by Pflug, 1961 (pl. 11, figs. 9, 10).

*Additions to original description*—Shell color pale tan with three wide reddish-brown bands, one on shoulder, one around mid-body, one around base; body whorl near lip pure white; interior of aperture white; protoconch and early whorls pale tan.

*Remarks*—The two specimens from the Golfo de Triste firmly establish this well known and distinctive Pliocene fossil as a component of the Recent Venezuelan fauna. *Antillophos elegans* can be separated from the South American variety of the ubiquitous Caribbean *A. candei* (d'Orbigny) (Figs. 41–42) by its smaller size, by having strong, beaded axial costae instead of a cancellate sculpture, and by having a color pattern of three solid red-brown bands. The Recent specimen illustrated is indistinguishable from the fossils illustrated by Pflug (1961, pl. 11, figs. 1, 3, 14, 16), in shape, sculpturing, and size. *Antillophos elegans* is sympatric with *A. candei* in the Golfo de Triste.

*Fossil distribution*—Gurabo formation, Santo Domingo; Bowden formation, Jamaica; Springvale formation, Trinidad; Punta Gavilán formation, Venezuela; Limón and Gatun formations, Costa Rica.

*Recent distribution*—Known only from the Golfo de Triste, Venezuela, 35 m depth.

Genus *Truncaria* Adams & Reeve, 1848

13. *Truncaria* sp.  
Figs. 45–48

*Material examined*—2 fragments, lengths 22 mm and 20 mm, P-734, 65 m depth off Cabo Cordera, Venezuela.

*Description*—Shell fragments smooth, pale cream colored, with fine brown revolving hairlines; sculptured with fine raised spiral striae.

*Remarks*—The two Cabo Cordera fragments constitute the first record of the paciphilic genus *Truncaria* in the Atlantic Ocean. Although these fragments represent a new Caribbean species, a formal description will have to wait until better material is collected. Enough of the body whorl is intact, however, to show that the new species is close to its Panamic cognate species, *Truncaria brun-*

*neopicta* (Dall, 1896). Both species have sculpturing of spiral striae and coloration of brown hairlines.

Family Fasciolariidae  
Subfamily Fasciolariinae  
Genus *Latirus* Montfort, 1810

14. *Latirus (Polygonia) anapetes*  
Woodring, 1964  
Figs. 49–50

*Latirus (Polygonia) anapetes* Woodring, 1964: 274, pl. 47, fig. 12. Jung, 1965: 539, pl. 73, fig. 1.

*Material examined*—Length 55 mm, P-708 (11°24.7'N, 62°40.5'W), 70 m depth; length 40 mm, P-736 (10°57'N, 65°52'W), 100 m depth; lengths 48 mm and 41 mm, P-718 (11°22.5'N, 64°08.6'W), 60 m depth.

*Additions to original description*—Shell color pale yellow-orange, darker on early whorls; interior of aperture white.

*Remarks*—The Recent specimen illustrated here is very similar to the fossil illustrated by Woodring (1964, pl. 47, fig. 12), especially so in that both have a widely-flaring umbilical region and a strongly constricted suture.

*Fossil distribution*—Chagres Sandstone, Gatun formation, Panamá.

*Recent distribution*—Off the Venezuelan coast, from the Peninsula de Paria to near Isla Margarita, 60–100 m depth.

Subfamily Fusininae Swainson, 1840  
Genus *Fusinus* Rafinesque, 1815

15. *Fusinus caboblanquensis*  
Weisbord, 1962  
Figs. 51–52

*Fusinus closter caboblanquensis* Weisbord, 1962: 364–368, pl. 32, figs. 13, 14, pl. 33, figs. 1, 2. J. Gibson-Smith & W. Gibson-Smith, 1979: 26.

*Material examined*—Length 160 mm, trawled by commercial shrimp boats from 25 m depth in Golfo de Venezuela, off Punto Fijo, Peninsula de Paraguaná, Venezuela, May, 1976, USNM 784462; length 111 mm, same locality and date, UMML 8280.

*Additions to original description*—Shell color pale tan, becoming darker on siphonal canal; siphonal canal tipped with dark brown;



FIGS. 49-60. 49-50. *Latirus anapetes* Woodring: P-708, L = 55 mm. 51-52. *Fusinus caboblanquensis* Weisbord: USNM 784462, L = 160 mm. 53-54. *Fusinus marensis* Weisbord: 784463, L = 112 mm. 55-56. *Ancilla venezuelana* Weisbord: P-722, L = 30 mm. 57-58. *Ancilla* sp.: USNM 784573, L = 35 mm. 59-60. *Oliva schepmani* Weisbord: USNM 784464, L = 39 mm.

base color overlaid with scattered brown vertical lines and spots; prominent raised shoulder keel white on knobs, dark brown in depressions; interior of aperture and columella white; outer lip edged with dark brown dashes; protoconch and early whorls brown.

*Remarks*—Although described as a fossil subspecies of the Recent *F. closter* (Philippi, 1951), *F. caboblanquensis* can be separated from that species on the basis of having a well developed and darkly colored shoulder keel. Together, the sharp-angled keeled shoulder and the regularly spaced axial folds give the shell a decidedly knobbed appearance. The more slender, white *F. closter* from Isla Margarita and the Lesser Antilles not only lacks the shoulder keel of *F. caboblanquensis* but also does not seem to reach the shell length of the relict species. The two species are sympatric along part of the Venezuelan coast.

*Fossil distribution*—Mare and Playa Grande formations, Venezuela.

*Recent distribution*—Known from near Isla Margarita to the Golfo de Venezuela, 25 m depth.

16. *Fusinus marensis* Weisbord, 1962  
Figs. 53–54

*Fusinus marensis* Weisbord, 1962: 262–264, pl. 32, figs. 11, 12.

*Material examined*—Length 112 mm, trawled by commercial shrimp boat, 20 m depth, in the Golfo de Venezuela off the Peninsula de Paraguaná, Venezuela, March, 1979, USNM 784463; lengths 53 mm and 50 mm, P-758 (11°42.4'N, 69°40'W), 16 m depth; lengths 36 mm and 27 mm, P-761 (11°52'N, 70°22'W), 35 m depth.

*Additions to original description*—Shell color tan, overlaid with numerous thin, dark brown vertical flammules; siphonal canal dark brown; protoconch and early whorls brown; columella and interior of aperture white; margin of lip and siphonal canal edged with purple.

*Remarks*—The holotype of *F. marensis* is a slender juvenile specimen only 50 mm in length. The specimen illustrated here is over twice that length and shows the bulbous, tabulate later whorls characteristic of this species. The early whorls and spiral sculpturing of the Recent specimens are otherwise indistinguishable from those of Weisbord's holotype.

*Fossil distribution*—Mare formation, Venezuela.

*Recent distribution*—Off the Venezuelan coast, from the Golfo de Venezuela to the Golfo de Triste, 15–35 m depth.

Family Olividae  
Genus *Ancilla* Lamarck, 1799

17. *Ancilla venezuelana* Weisbord, 1962  
Figs. 55–56

*Ancilla (Eburna) venezuelana* Weisbord, 1962: 393–395, pl. 36, figs. 5, 6. Gibson-Smith & Gibson-Smith, 1979: 26.

*Material examined*—Lengths 30 mm and 13 mm, P-722 (11°04'N, 64°44'W), 91 m depth; 2 fragments, lengths 21 mm and 20 mm, P-722; length 30 mm, P-734 (11°01.8'N, 65°34.2'W), 64 m depth.

*Additions to original description*—Shell color bright red-orange; spire and upper one-half to one-third of body whorl glazed over with yellow-orange enamel; enamel of subsutural area darker orange; fascicular area bipartite, dark orange on anterior half, paler orange on posterior half; protoconch and glazed early whorls pale yellow-orange; interior of aperture orange; operculum thin, corneous, yellow-brown.

*Remarks*—Although considered a synonym of the Recent *A. tankervillei* (Swainson, 1825) by Gibson-Smith & Gibson-Smith (1979: 26), *A. venezuelana* is a valid species. This relict has a more slender, fusiform shell, contrasting with the turreted outline of *A. tankervillei*. *Ancilla venezuelana* can also be distinguished from *A. tankervillei* by its smaller size, deep orange-red callus color and form and extent of the subsutural callus. The callus does not extend as far onto the body whorl as that seen in *A. tankervillei*. The extent of the subsutural nacre of *A. venezuelana* varies with individuals. One specimen (P-734) had a callus arrangement similar to the holotype illustrated by Weisbord (1962, pl. 36, figs. 5, 6), while the specimen here illustrated had a less extensive area of callus. This variability of nacre production is not seen in *A. tankervillei*.

*Fossil distribution*—Mare formation, Venezuela.

*Recent distribution*—Off the Venezuelan coast from the Golfo de Triste to Isla Margarita, in depths of 60–100 m.

18. *Ancilla* sp.  
Figs. 57–58

*Material examined*—Length 35 mm, trawled by commercial shrimp boats from 35 m depth in Golfo de Triste, Venezuela, March, 1979, USNM 784573.

*Description*—Shell shiny, elongate; spire turreted, ½ of total shell length; color pale yellow-orange.

*Remarks*—Although similar to the sympatric *Ancilla venezuelana*, the single specimen shown here appears to represent a new species. I have included this new species with the other relicts in order to emphasize the unusual nature of the northern South American olivid fauna. Here, and nowhere else in the Atlantic Ocean, are five species of *Ancilla* all living in close proximity; *Ancilla venezuelana*, along with the new species, being restricted to the Golfo de Triste; *A. balteata* (Swainson, 1825) being endemic to neighboring Aruba; and *A. glabrata* (Linnaeus, 1758) and *A. tankervillei* being widespread along the entire coast. In the Golfo de Triste, the new species, *A. venezuelana*, *A. glabrata*, and *A. tankervillei* are all sympatric and the last three mentioned species are often brought up together in the same net haul.

Genus *Oliva* Hwass, 1789

19. *Oliva schepmani* Weisbord, 1962  
Figs. 59–60

*Oliva schepmani* Weisbord, 1962: 370–374, pl. 33, figs. 5–13. Gibson-Smith & Gibson-Smith, 1979: 24.

*Material examined*—Length 39 mm, trawled by commercial shrimp boats, from 30 m depth, in the Golfo de Triste, Venezuela, March, 1979, USNM 784464; lengths 42 mm and 41 mm, same location, depth, and date, UMML 8281.

*Additions to original description*—Shell color dark greenish-gray mottled with pale brown; base color overlaid with numerous fine pale green triangular markings; body whorl with two faint bands of brown vertical lines, one anterior to mid-body line, one posterior; suture edged with band of alternating black and yellow dashes; spire with thin, pale purple callus; protoconch purplish-brown; interior of aperture pale purple becoming grayish-yellow toward edge of lip; columella lavender-purple; posterior edge of columella with deep purple

stain; anterior tip of fasciole with large, deep purple spot; interior of siphonal canal with thin, pale purple callus; protoconch purplish-brown; interior of aperture pale purple becoming grayish-yellow toward edge of lip; columella lavender-purple; posterior edge of columella with deep purple stain; anterior tip of fasciole with large, deep purple spot; interior of siphonal canal with purple stain; animal color pale yellow-orange to cream with numerous dark brown little flecks.

*Remarks*—Among the fossil Olividae, *O. schepmani* most closely resembles *O. couvana* Maury, 1925, from the Springvale formation of Trinidad. *Oliva couvana*, however, is a more slender shell, and differs from *O. schepmani* in having a higher spire. Of the Recent Olividae, the relict most closely resembles *O. julietta* Duclos, 1833 from the Panamic Province. That species has a larger shell and a completely different color pattern, with a yellow and green base color with prominent scattered black spots and white triangles. The Recent *O. fulgurator* Lamarck, 1810, endemic to Aruba, is similar to *O. schepmani* but differs in being more inflated, by having a white base color patterned with orange-red flammules and triangles, and by having a much larger protoconch in proportion to the shell size.

*Fossil distribution*—Mare, Playa Grande, and Abisinia formations, Venezuela.

*Recent distribution*—Known only from the Golfo de Triste, Venezuela.

Family Mitridae

Genus *Subcancilla* Olsson & Harbison, 1953

20. *Subcancilla illacidata* (Woodring, 1928)  
Figs. 63–65

*Mitra (Tiara) henekeni illacidata* Woodring, 1928; 243, pl. 14, fig. 13.

*Material examined*—Three specimens, lengths 15 mm, 17 mm, 18 mm, trawled by commercial shrimp boats from 35 m depth in Golfo de Triste, Venezuela, March, 1979, USNM 784574.

*Additions to original descriptions*—Shell color very pale yellow, some specimens with pale brown vertical flammules.

*Remarks*—*Subcancilla illacidata* resembles members of the widespread Miocene *S. dariensis* (Brown & Pilsbry, 1911) complex but differs in having only three

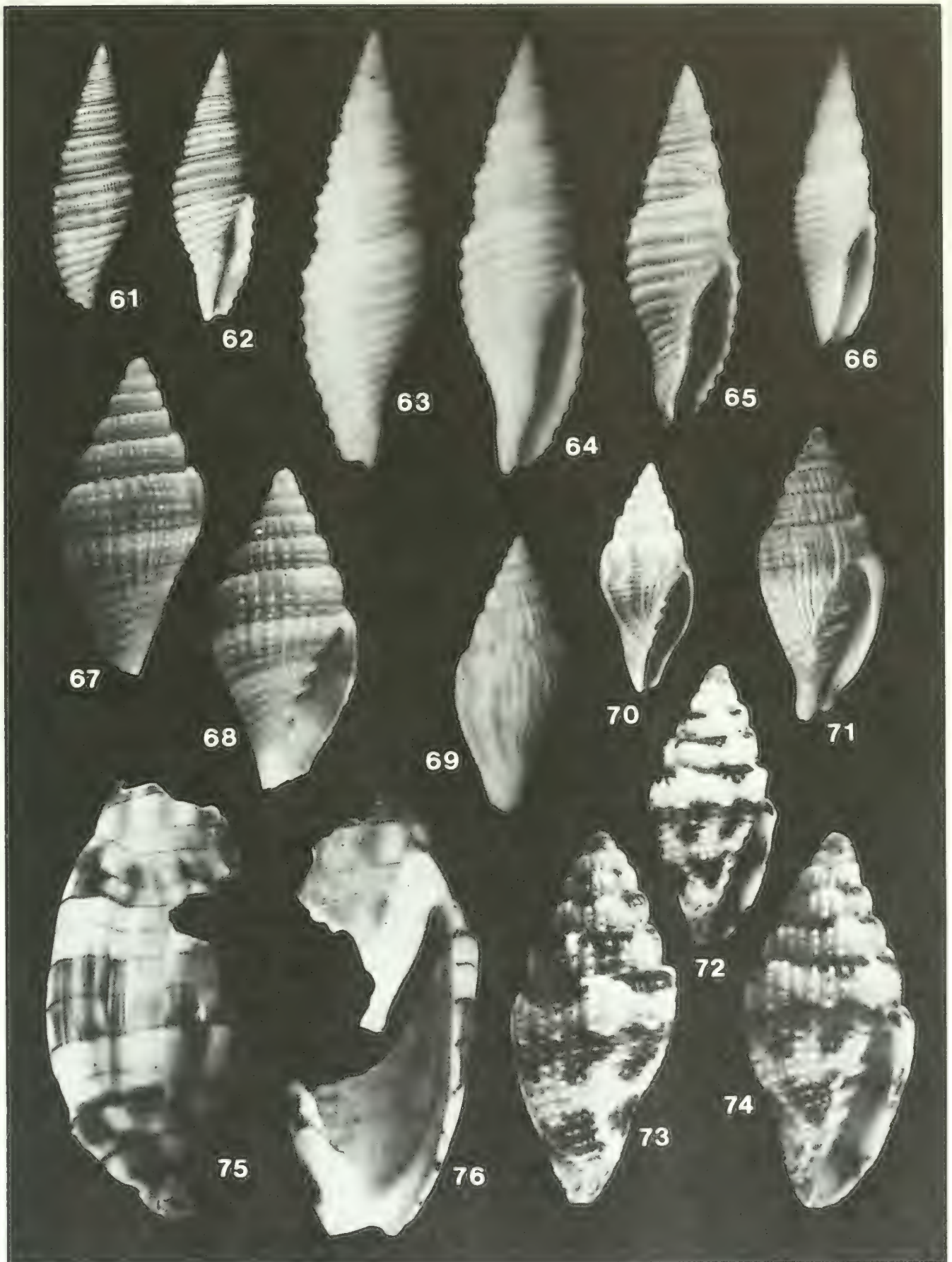

FIGS. 61–76. 61–62. *Subcancilla rhadina* (Woodring): P-749, L = 21 mm. 63–64. *Subcancilla illacidata* (Woodring): USNM 784574, L = 18 mm. 65. *Subcancilla illacidata* (Woodring): USNM 784574, L = 15 mm. 66. *Subcancilla venezuelana* (F. Hodson): USNM 784575, L = 24 mm. 67–68. *Conomitra caribbeana* Weisbord: P-722, L = 12 mm. 69–70. *Conomitra lehneri* Jung: USNM 784576, L = 15 mm. 71. *Conomitra lehneri* Jung: USNM 784576, L = 14 mm. 72–74. *Conomitra* sp.: USNM 784577, L = 10 mm. 75–76. *Lyria* cf. *limata* S. Hoerle & E. Vokes: P-758, fragment, L = 72 mm.

columellar plications instead of the four seen in the *S. dariensis* complex. In the Recent fauna, *S. funiculata* from the Panamic Province shows a close relationship to this relict species.

*Fossil distribution*—Bowden formation, Jamaica.

*Recent distribution*—Known only from the Golfo de Triste, Venezuela, 59 m depth.

21. *Subcancilla rhadina* (Woodring, 1928)  
Figs. 61–62

*Mitra rhadina* Woodring, 1928: 243–244, pl. 14, fig. 14.

*Material examined*—Three specimens, lengths 20 mm, 21 mm, and 29 mm, P-749 (10°37'N, 67°57.9'W), 59 m depth.

*Additions to original description*—Shell color pure white with raised light brown spiral cords.

*Remarks*—*Subcancilla rhadina* resembles the previous species but differs in being a more slender, high-spined shell, and in having more numerous and brown-colored spiral cords.

*Fossil distribution*—Bowden formation, Jamaica.

*Recent distribution*—35 m depth in Golfo de Triste, Venezuela.

22. *Subcancilla venezuelana*  
(F. Hodson, 1931)  
Fig. 66

*Mitra dariensis venezuelana* F. Hodson in F. Hodson & H. K. Hodson, 1931: 42, pl. 20, figs. 6, 7.

*Material examined*—Two specimens, both lengths 24 mm, trawled by commercial shrimp boats from 35 m depth in Golfo de Triste, March, 1979, USNM 784575.

*Additions to original description*—Shell color pure white.

*Remarks*—The two Recent specimens agree closely with Hodson's figured specimen. As pointed out by Woodring (1964: 284), *S. venezuelana* is more closely related to the Miocene *S. longa* (Gabb, 1873) than to such members of the *S. henekeni* complex as *S. dariensis* or *S. colombiana* (Weisbord, 1929). The major differentiating characteristics that separate *S. venezuelana* from the *S. henekeni* complex are the more numerous spiral cords, higher spire, and attenuated body form.

*Fossil distribution*—Mio-Pliocene beds of Falcón State, Venezuela.

*Recent distribution*—35 m depth in Golfo de Triste, Venezuela.

Family Volutomitridae  
Genus *Conomitra* Conrad, 1865

This genus was thought to have been extinct since the upper Miocene (Gardner, 1937: 420), and the following three species constitute the first records of the genus from the Recent Caribbean fauna. The Recent species assigned to this genus by Dall (1889: "*Conomitra*" *blakeana*, "*Conomitra*" *laevior*, and "*Conomitra*" *intermedia* have now been shown to be members of the genus *Microvoluta* (Abbott, 1974: 240–241).

23. *Conomitra caribbeana* Weisbord, 1929  
Figs. 67–68

*Conomitra caribbeana* Weisbord, 1929: 48, pl. 6, figs. 14, 15.

*Material examined*—Two specimens, lengths 12 mm and 14 mm, P-722 (11°0.4'N, 64°44'W), 91 m depth.

*Additions to original description*—Shell color tan, with two narrow white bands, one above mid-body line, one below mid-body line; interior of aperture tan with white band; protoconch large, glassy, tan in color.

*Remarks*—*Conomitra caribbeana* differs from the following species by having fewer axial ribs per whorl and by lacking the vertical flammules characteristic of *C. lehneri*.

*Fossil distribution*—Tuberá formation, Colombia.

*Recent distribution*—Off Isla Margarita, Venezuela, 91 m depth.

24. *Conomitra lehneri* Jung, 1971  
Figs. 69–71

*Conomitra lehneri* Jung, 1971: 200–201, pl. 14, figs. 12–16.

*Material examined*—Eleven specimens, lengths 12 mm to 18 mm, trawled by commercial shrimp boats from 35 m depth in Golfo de Triste, Venezuela, March, 1979, USNM 784576.

*Additions to original description*—Shell color white with numerous axial flammules and zigzags of tan; some specimens also encircled with two tan bands.

*Remarks*—The Recent specimens shown here closely resemble the fossil type series illustrated by Jung, having the same general body form and numerous thin axial ribs.

*Fossil distribution*—Grand Bay formation, Carriacou, Grenadines, Lesser Antilles.

*Recent distribution*—Golfo de Triste, Venezuela, 35 m depth.

25. *Conomitra* sp.  
Figs. 72–74

*Material examined*—Length 10 mm, trawled by commercial shrimp boat in 35 m depth off Cabo La Vela, Peninsula de Guajira, Colombia, December, 1974, USNM 784577.

*Shell description*—Shiny, with 5 whorls; body with numerous fine axial ribs intersected with numerous spiral ribs, giving shell pustulose appearance; protoconch large, bulbous, composed of 2 whorls; columella with four plications; color pale tan with 2 bands of arrow-shaped dark brown flammules; shoulder with intermittent dark brown blotches; between dark shoulder blotches are small white patches; tan base color overlaid with pattern of spiral bands of small brown dots; protoconch brown; interior of aperture tan with two bands of dark brown.

*Remarks*—This small *Conomitra* is quite unlike its sympatric congeners and represents an undescribed species. The brown and white color markings readily separate the new species from both *C. caribbeana* and *C. lehneri*.

Family Volutidae

Subfamily Lyriinae Pilsbry & Olsson, 1954

Genus *Lyria* Gray, 1847

26. *Lyria* cf. *limata* S. Hoerle & E. Vokes, 1978  
Figs. 75–76

*Lyria limata* S. Hoerle & E. Vokes, 1978: 111, pl. 1, figs. 4a, 4b, 5a, 5b.

*Material examined*—Fragment, length 72 mm, P-758 (11°42.4'N, 69°40'W), 16 m depth.

*Additions to original description*—Shell color pale yellowish-tan with three broad light brown bands, one on shoulder, one around mid-body, one at base in siphonal region; three bands darker when crossing axial costae; shoulder and mid-body bands overlaid by three dark brown continuous spiral stripes; basal band overlaid by five stripes; pale tan areas between bands with the three

dark brown spiral stripes; dark spiral stripes continue as sharp barbs on margin of outer lip; inner side of lip pale orange; columella pale yellow.

*Remarks*—Unfortunately, this giant *Lyria* is only known from the Recent as a single fragment, roughly one-third of the body whorl, a small portion of the columellar region, and a small section of the preceding whorl. The height and form of the missing spire can only be guessed at. Judging from the general shell contours of other species of *Lyria*, it would appear that a complete specimen of the Golfo de Triste *Lyria* would probably exceed 100 mm in length. Because of the incomplete condition, the specimen is referred with some reservation to Hoerle & Vokes' taxon.

The ultra-violet light photographs of the holotype of *L. limata* illustrated by Hoerle & Vokes (1978, pl. 1, figs. 5a, 5b) show a color pattern identical to that of the Venezuelan fragment. The contours of the outer lip and the arrangement and coloring of the axial costae of both the fossil holotype and the Recent fragment are also identical. The main difference between the fossil and Recent specimen is one of size; the entire holotype is only 38.8 mm in length while the fragment alone is 72 mm in length.

Of all the Recent northern South American relicts, *L. limata* is the only species to have been originally described from the northern Caribbean region (Chipola formation of Florida). Its disappearance from Florida Pliocene assemblages, its absence from Mio-Pliocene assemblages in the Gatunian region and its reappearance in the Recent along a small stretch of Venezuelan coastline is problematical.

*Fossil distribution*—Chipola formation, Florida.

*Recent distribution*—Known only from the Golfo de Triste, Venezuela.

Family Marginellidae

Genus *Persicula* Schumacher, 1817

27. *Persicula (Rabicea) hodsoni*  
Weisbord, 1962  
Figs. 77–78

*Persicula (Rabicea) hodsoni* Weisbord, 1962: 412–413, pl. 38, figs. 5–8.

*Persicula interruptolineata* J. Gibson-Smith & W. Gibson-Smith, 1979 (*non* Megerle von Mühlfeld, 1816): 26.

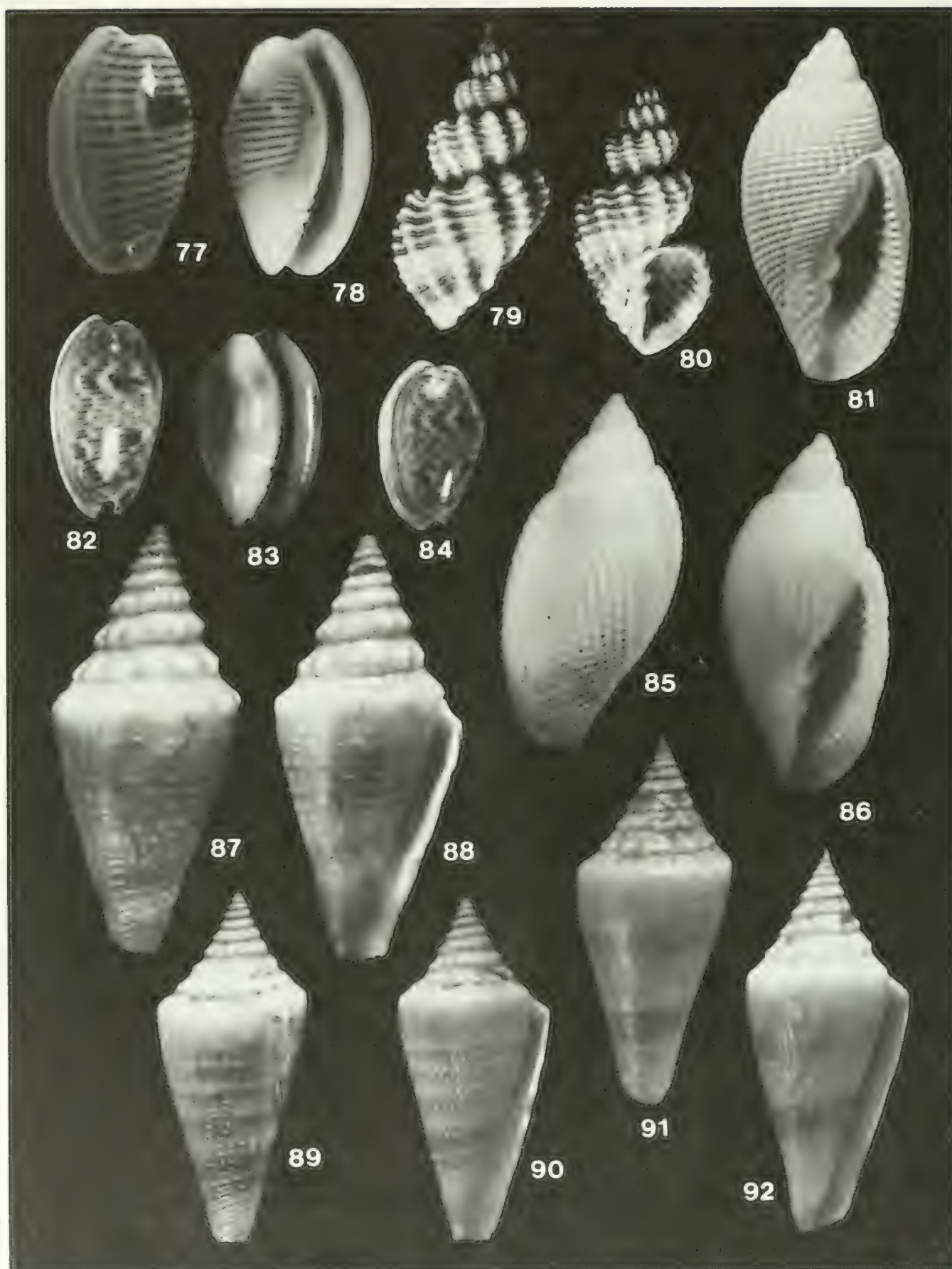

FIGS. 77-92. 77-78. *Persicula hodsoni* Weisbord: USNM 784466, L = 14 mm. 79-80. *Agatrix epomis* (Woodring): P-750, L = 16 mm. 81. *Aphera islacolonis* (Maury): USNM 784467, L = 10 mm, shell sculpture enhanced by coating with magnesium oxide. 82-83. *Persicula interruptolineata* (Megerle von Mühlfeld): USNM 784465, L = 12 mm. 84. *Persicula interruptolineata*: USNM 784465, L = 11 mm. 85-86. *Aphera islacolonis* (Maury): USNM 784467, L = 10 mm. 87-88. *Conus consobrinus* Sowerby: P-708, L = 28 mm. 89-90. *Conus consobrinus* Sowerby: P-734, L = 33 mm. 91-92. *Conus consobrinus* Sowerby: P-734, L = 42 mm.



*Material examined*—Length 14 mm, on beach, Adicora, Peninsula de Paraguaná, Venezuela, April, 1975, USNM 784466.

*Additions to original description*—Shell color cream-white overlaid with 15 dark red-brown stripes; callused outer lip and columellar region white; interior of aperture white; body whorl with large rectangular dark brown patch on dorsum, slightly posterior to midline.

*Remarks*—Although considered a synonym of *P. interruptolineata* (Megerle von Mühlfeld, 1816) by Gibson-Smith & Gibson-Smith (1979: 26), *P. hodsoni* is a valid species. Both marginellids occur sympatrically along the coast of the Peninsula de Paraguaná, although *P. interruptolineata* has a more extensive range throughout the southern Caribbean.

*Persicula hodsoni* can be separated from *P. interruptolineata* by its larger size and by its color pattern; fifteen red-brown stripes, broken a few times by vertical white bars, as opposed to the numerous rows of brown dots seen in *P. interruptolineata* (Figs. 82–84). This striped pattern is similar to that of *P. bandera* Coan & Roth, 1965 from the Panamic Province.

*Fossil distribution*—Mare and Abisinia formations, Venezuela.

*Recent distribution*—Along the Peninsula de Paraguaná, Venezuela.

Family Cancellariidae  
Genus *Agatrix* Petit, 1967

28. *Agatrix epomis* (Woodring, 1928)  
Figs. 79–80

*Tribia epomis* Woodring, 1928: 223, pl. 12, fig. 10.

*Agatrix epomis*, Petit, 1976: 38, pl. 1, fig. 3.

*Material examined*—Length 11 mm, P-717 (11°21'N, 64°10'W), 64 m depth; 6 specimens, 7–10 mm, P-718 (11°22.5'N, 64°8.6'W), 60 m depth; lengths 7 mm and 17 mm, P-721 (11°6.5'N, 64°22.5'W), 26 m depth; lengths 12 mm and 16 mm, P-750 (10°36.1'N, 68°12.2'W), 24 m depth.

*Major citations*—Living specimens recognized, described, and illustrated by Petit, 1976.

*Remarks*—After the discovery of living *Fusiturricula jaquensis* (Sowerby) (described by Altena, 1975), *A. epomis* was the second known living example of a supposedly-extinct

Gatunian species. The R/V Pillsbury specimens show that this relict is a relatively common member of the offshore Venezuelan molluscan assemblages.

*Fossil distribution*—Bowden formation, Jamaica.

*Recent distribution*—Along the Colombian and Venezuelan coasts, in depths of 24–64 m.

Genus *Aphera* H. & A. Adams, 1854  
29. *Aphera islacolonis* (Maury, 1917)  
Figs. 81, 85–86

*Cancellaria islacolonis* Maury, 1917: 65, pl. 10, figs. 12, 12a, 12b.

*Cancellaria (Aphera) islacolonis*, Olsson, 1922: 86, pl. 6, fig. 12.

*Cancellaria ellipsis* Pilsbry, 1922: 333–334, pl. 22, figs. 8, 9.

*Aphera islacolonis*, Woodring, 1970: 344, pl. 56, figs. 1, 2.

*Material examined*—Length 10 mm, trawled by commercial shrimp boats, from 35 m depth, in Golfo de Triste, Venezuela, March, 1979, USNM 784467.

*Additions to original description*—Shell color white; dorsum with single large light tan patch; interior of aperture white; Fig. 81 shows characteristic cancellate sculpture, enhanced by coating of magnesium oxide.

*Remarks*—The discovery of a living *Aphera* in the Atlantic demotes the genus from the rank of paciphile (Vermeij, 1978: 232, table 8.2)—in having a single Panamic species, *A. tessellata* (Sowerby, 1832), and a Caribbean species, *A. islacolonis*. The Recent specimen is very close to the fossils illustrated by Maury (1917, pl. 10, figs. 12a, 12b) and Olsson (1922, pl. 6, figs. 1, 2), but differs in having finer sculpture than the fossil illustrated by Woodring (1970, pl. 56, figs. 1, 2). This mutability of sculpture patterns is probably representative of ecophenotypic variation and not full species rank (Woodring, 1970: 344). The Golfo de Triste *Aphera* is identical in sculpture to *A. ellipsis* (Pilsbry, 1922: pl. 22, figs. 8, 9), which Pilsbry himself (p. 334) said may be only the juvenile of *A. islacolonis*.

*Fossil distribution*—Cercado and Gurabo formations, Santo Domingo; Gatun formation, Costa Rica and Panamá.

*Recent distribution*—Known only from the Golfo de Triste, Venezuela, 35 m depth.

Family Conidae  
Genus *Conus* Linnaeus, 1758

30. *Conus consobrinus* Sowerby, 1850  
Figs. 87–92

*Conus consobrinus* Sowerby, 1850: 45.  
Woodring, 1928: 214–215, pl. 11, figs. 6, 7.  
Pflug, 1961: 62, pl. 17, figs. 1–10.

*Material examined*—Lengths 42 mm and 33 mm, P-734 (11°1.8'N, 65°40.5'W), 65 m depth; length 28 mm, P-708 (11°24.7'N, 62°40.5'W), 70 m depth; length 34 mm, P-773 (12°17'N, 72°15'W), 62 m depth.

*Major citations*—Redescribed, with diagnosis, by Woodring, 1928; lectotype and type series illustrated by Pflug, 1961, pl. 17, figs. 1–10.

*Additions to original description*—Shell color pale salmon-pink with prominent wide orange band just posterior to anterior tip; body whorl with thin orange bands, varying from one to four, posterior to mid-body line; base color overlaid with numerous faint spiral rows of tiny pale orange dots; spire salmon-pink with scattered dark orange flammules; interior of aperture pale orange; juvenile specimens heavily pustulose, strongly coronated, and biconic; adult specimens smoother, more elongated, with shoulder of last whorl non-coronate.

*Remarks*—This once-widespread Gatunian indicator species is now restricted to deeper water off the Colombian and Venezuelan coasts. *Conus consobrinus* is so distinctive that it cannot be confused with any other living western Atlantic cone. This relict is related to the Recent *C. cedonulli-mappa-aurantius* species complex of the Lesser Antilles and shallow water areas along the Colombian and Venezuelan coasts. *Conus consobrinus* can be separated from members of this complex by its high, heavily coronated spire and by the lack of the elaborate color patterns characteristic of the *C. cedonulli* group.

The small specimen from P-708 (Figs. 87–88) is similar to the fossil illustrated by Woodring (1928, pl. 11, fig. 7), while the large specimen from P-734 (Figs. 89–90) is virtually identical to the fossil illustrated by Pflug (1961, pl. 17, fig. 6).

*Fossil distribution*—Aguaguexquite formation, Mexico; Gurabo formation, Santo Domingo; Bowden formation, Jamaica; Grand Bay formation, Carriacou; Gatun formation, Costa Rica and Panamá.

*Recent distribution*—30–80 m depth off Venezuela and northern Colombia.

31. *Conus planiliratus* Sowerby, 1850  
Figs. 93–95

*Conus planiliratus* Sowerby, 1850: 44.  
Olsson, 1922: 50, pl. 3, figs. 10, 13. Woodring, 1928: 210–212, pl. 10, figs. 7–9, pl. 11, figs. 1, 2.

*Material examined*—Lengths 27 mm and 21 mm, 25 m depth in Golfo de Triste, Venezuela, trawled by commercial shrimpers, March, 1979, USNM 784469.

*Major citations*—Redescribed in detail by Woodring, 1928, with discussion of possible species complex.

*Additions to original descriptions*—Shell color white to salmon-pink, with two bands of yellow maculations around mid-body; spire with scattered small, brown, crescent-shaped flammules; aperture white, periostracum thin, smooth, translucent yellow.

*Remarks*—The four known Recent specimens are indistinguishable from the fossil specimens illustrated by Olsson (1922, pl. 3, fig. 10) and Woodring (1928, pl. 10, figs. 7, 9). The only Recent cone that bears any resemblance to *C. planiliratus* is *C. stimpsoni* Dall, 1902, from deep water off Florida, Georgia, the Carolinas, and in the Gulf of Mexico. *Conus planiliratus* differs from *C. stimpsoni* by being a consistently more slender shell, by having two bands of yellow maculations around the mid-body, by having a heavily sculptured spire, and by having numerous incised spiral sulci on the body whorl. Woodring (1970: 346) was correct in his prediction that *C. planiliratus* could still be living in the Atlantic.

*Fossil distribution*—Bowden formation, Jamaica; Gurabo formation, Santo Domingo; Gatun and Limón formations, Costa Rica.

*Recent distribution*—In the Golfo de Triste, Venezuela, 35 m depth.

32. *Conus symmetricus* Sowerby, 1850  
Figs. 96–97

*Conus symmetricus* Sowerby, 1850: 44, pl. 9, fig. 1. Maury, 1917: 200, pl. 7, fig. 7. Woodring, 1928: 204. Pflug, 1961: 63–64, pl. 18, figs. 1–11. Woodring, 1970: 35–354.

*Material examined*—Length 37 mm, trawled by commercial shrimp boats, 35 m depth, in

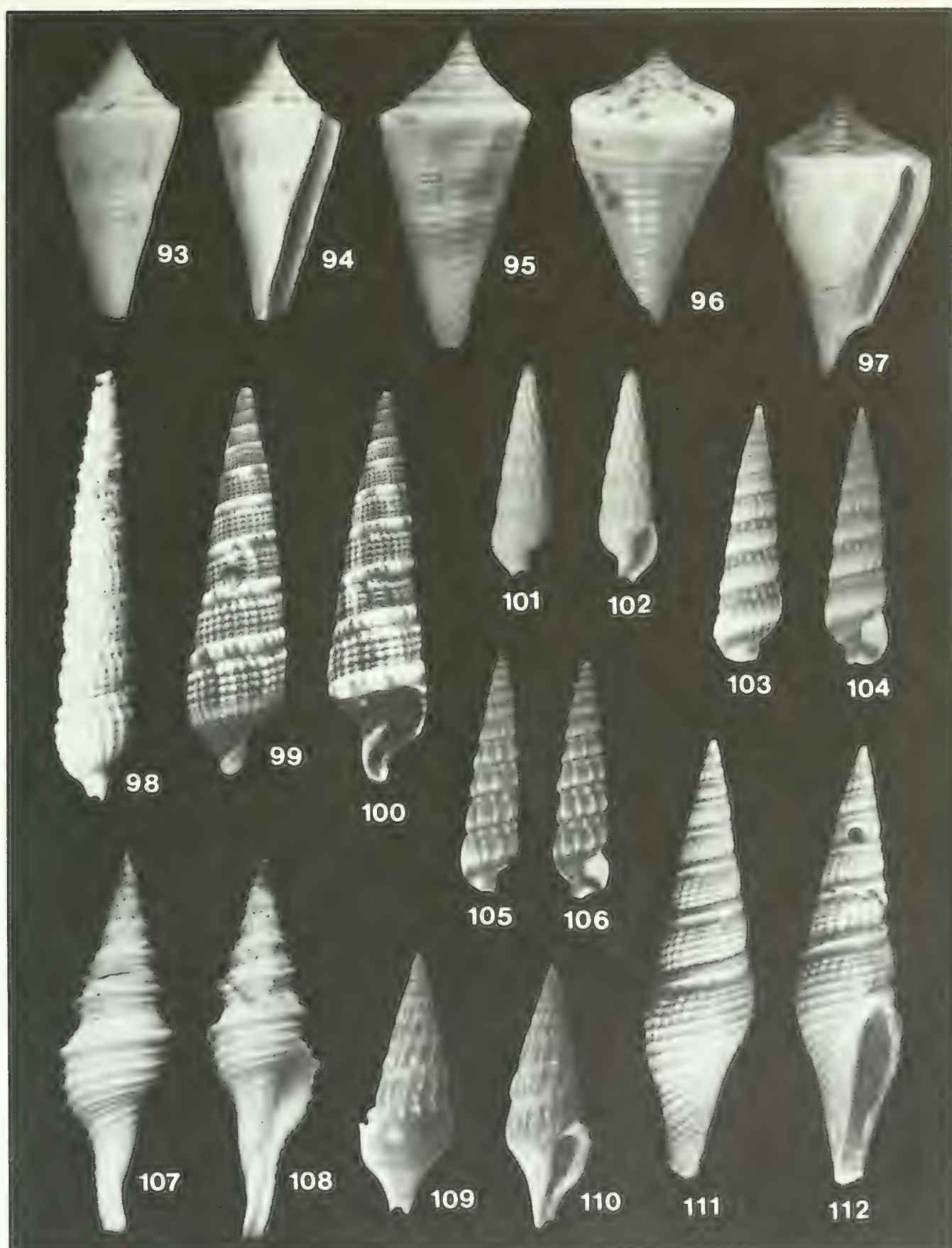

FIGS. 93–112. 93–94. *Conus planiliratus* Sowerby: USNM 784469, L = 21 mm. 95. *Conus planiliratus* Sowerby: USNM 784469, L = 27 mm. 96–97. *Conus symmetricus* Sowerby: USNM 784470, L = 37 mm. 98. *Strioterebrum bowdenensis* (Woodring): USNM 784578, L = 20 mm. 99–100. *Strioterebrum gatunense kugleri* (Rutsch): USNM 784471, L = 33 mm. 101–102. *Strioterebrum ischna* (Woodring): USNM 784579, L = 11 mm. 103–104. *Strioterebrum quadrispiralis* (Weisbord): USNM 784472, L = 13 mm. 105–106. *Strioterebrum trispiralis* (Weisbord): USNM 784473, L = 14 mm. 107–108. *Polystira barretti* (Guppy): USNM 784477, L = 63 mm. 109–110. *Agladrillia lassula* Jung: USNM 784474, L = 25 mm. 111–112. *Hindsiclava consors* (Sowerby): USNM 784476, L = 38 mm.

Golfo de Triste, Venezuela, March, 1970, USNM 784470.

*Major citations*—Lectotype and representative series illustrated by Pflug, 1961, pl. 18, figs. 4, 8, 11.

*Additions to original description*—Body whorl sculptured with 18 prominent, raised, pustulated spiral cords; spire sculpture with six incised spiral sulci; shell color pure white with small scattered pale orange-brown flammules; spire white with regularly-spaced, intermittent brown flammules; protoconch and early whorls pale orange; aperture white.

*Remarks*—The wide-shouldered and flat-spined aspects of *C. symmetricus* are unlike those of any other living cone. The Recent specimen shown here easily fits into the series illustrated by Pflug (1961, pl. 18, figs. 1–11), especially so in having spiral rows of raised pustules on the body whorl and in having a characteristically sculptured spire like that of Pflug's fig. 5 and as seen here in Fig. 96. One of the specimens of Pflug's series (fig. 6) is nearly identical to the Recent Venezuelan specimen.

*Fossil distribution*—Bowden formation, Jamaica; Gurabo formation, Santo Domingo; Gatun formation, Costa Rica and Panamá.

#### Family Terebridae

#### Genus *Strioterebrum* Sacco, 1891

33. *Strioterebrum bowdenensis* (Woodring, 1928)  
Fig. 98

*Terebra (Strioterebrum) bowdenensis* Woodring, 1928: 138–139, pl. 3, figs. 3–8.

*Material examined*—Two specimens, lengths 20 mm and 22 mm, trawled by commercial shrimp boats from 35 m depth in Golfo de Triste, Venezuela, December, 1978, USNM 784578.

*Additions to original description*—Shell pure white.

*Remarks*—The two Recent specimens are indistinguishable from the type-series illustrated by Woodring, both in size and sculpturing.

*Fossil distribution*—Bowden formation, Jamaica.

*Recent distribution*—In Golfo de Triste, Venezuela, 35 m depth.

34. *Strioterebrum gatunensis kugleri*  
(Rutsch, 1934)  
Figs. 99–100

*Terebra (Strioterebrum) gatunensis kugleri*  
Rutsch, 1934: 106–108, pl. 8, fig. 18, pl. 9, figs. 12, 13. Weisbord, 1962: 428–430, pl. 40, figs. 12, 13, pl. 45, figs. 24, 25.

*Material examined*—Lengths 33 mm and 32 mm, on beach, Crespo, Cartagena, Colombia, after storm, December, 1974, USNM 784471; length 24 mm, same locality and data, UMML 8282.

*Major citations*—Redescribed in detail, with diagnosis, by Weisbord, 1962.

*Additions to original description*—Shell color deep gray-brown with alternating flammules of dark brown; beaded junctions of axial cords and spiral ridges light tan; lower part of body whorl with white band; base of shell dark chocolate brown; subsutural collar white with alternating brown patches corresponding to brown flammules on body whorl; interior of aperture dark brown.

*Remarks*—Besides lack of color, the fossil specimen of *S. gatunensis kugleri* illustrated by Weisbord (1962, pl. 40, figs. 12, 13) is almost identical to the Recent specimen illustrated here. The color pattern of brown flammules and checkers and the distinctive sculpturing of raised beads readily separates *S. gatunensis kugleri* from any other known Recent Atlantic *Strioterebrum*.

The relict species is closest to *S. spiriferum* (Dall, 1895) from the Gurabo formation, Santo Domingo, and also *S. glaucum* (Hinds, 1844) from the Panamic Province. *Strioterebrum gatunensis kugleri* is well-represented in the fossil record of Venezuela.

*Fossil distribution*—Punta Gavilán, Mare, and Cabo Blanco formations, Venezuela.

*Recent distribution*—Known only from the Colombian coast near Cartagena but probably occurs elsewhere along the Colombian and Venezuelan coasts.

35. *Strioterebrum ischna* (Woodring, 1928)  
Figs. 101–102

*Terebra (Strioterebrum) ischna* Woodring, 1928: 142, pl. 3, fig. 18, pl. 4, fig. 1.

*Material examined*—Five specimens, lengths 6–11 mm, on beach, Adícora, Penin-

sula de Paraguaná, Estado Falcón, Venezuela, December, 1974, USNM 784579.

*Addition to original description*—Shell color uniformly pale tan.

*Remarks*—The Recent specimens are identical to the fossil type-specimens illustrated by Woodring.

*Fossil distribution*—Bowden formation, Jamaica.

*Recent distribution*—North end of Península de Paraguaná, Venezuela.

36. *Strioterebrum quadrispiralis*

(Weisbord, 1962)

Figs. 103–104

*Terebra (Strioterebrum) quadrispiralis* Weisbord, 1962: 431–432, pl. 41, figs. 1–4.

*Material examined*—Three specimens, lengths 11–13 mm, on beach, Adicora, Península de Paraguaná, Venezuela, April, 1975, USNM 784472; length 11 mm, on beach, Punta Mangle, Isla Margarita, Venezuela, 1977, UMML 8282 (from Gibson-Smith collection).

*Additions to original description*—Shell color pale rose-white with darker band along suture; base of shell dark reddish-brown; interior of aperture white, dark reddish-brown in siphonal region; protoconch white.

*Remarks*—Along with the following species, this small terebrid resembles no other living Atlantic species. *Strioterebrum quadrispiralis* and *S. trispiralis* represent the last of a long lineage of small, beaded terebrids centered around the Middle Miocene *S. eleutheria* (Woodring, 1928) and *S. midiensis* (Olsson, 1922).

This and the following species may be population variants of an undescribed Bowden species (Woodring, 1928: pl. 3, figs. 13, 14). As such, they would represent true relict species. If they are distinct species that have long been endemic to the Venezuelan coast, however, they may only represent old, unchanged species inhabiting their original range and would not be considered true relicts. In either case, the existence of these two terebrids reinforces the archaic nature of the relict pocket.

*Fossil distribution*—Mare formation, Venezuela.

*Recent distribution*—From the Península de Paraguaná to Isla Margarita, Venezuela, in shallow water.

37. *Strioterebrum trispiralis*

(Weisbord, 1962)

Figs. 105–106

*Terebra (Strioterebrum) trispiralis* Weisbord, 1962: 430–431, pl. 40, figs. 14, 15.

*Material examined*—Lengths 14 mm and 13 mm on beach, Adicora, Península de Paraguaná, Venezuela, April, 1975, USNM 784473; 3 specimens, lengths 11–14 mm, on beach Punta Mangle, Isla Margarita, Venezuela, 1977, UMML 8283 (from Gibson-Smith collection).

*Additions to original description*—Shell color gray-brown, darker along suture; base dark purple-brown; interior of aperture white, purple in siphonal region.

*Remarks*—*Strioterebrum trispiralis* is closely related to the preceding species, and pending anatomical studies, may prove to be conspecific. The main difference between the two species is seen in the structure and form of the varices and varical nodes. In *S. trispiralis*, the varices are complete, forming costae that are intersected by two spiral sulci, giving the shell the characteristic tripartite form. In *S. quadrispiralis*, the varices are intersected by three sulci, giving the effect of four rows of raised beads.

*Fossil distribution*—Mare formation, Venezuela.

*Recent distribution*—From the Península de Paraguaná to Isla Margarita, Venezuela, in shallow water.

Family Turridae

Subfamily Turrinae Swainson, 1875

Genus *Polystira* Woodring, 1928

38. *Polystira barretti* (Guppy, 1866)

Figs. 107–108

*Pleurotoma barretti* Guppy, 1866: 290, pl. 17, fig. 6.

*Turris albidula barretti*, Maury, 1917: 214, pl. 8, fig. 5.

*Polystira barretti*, Woodring, 1928: 146, pl. 4, fig. 6. Pflug, 1961: 70–71, pl. 20, figs. 1, 4.

*Material examined*—Length 63 mm, trawled by commercial shrimp boat, 35 m depth, in Golfo de Triste, Venezuela, March, 1979, USNM 784477; length 72 mm, trawled by

commercial shrimp boat, 35 m depth, off Cabo La Vela, Peninsula de Guajira, Colombia, December, 1974 (with *Crucibulum mareense* attached), USNM 784478; lengths 65 mm and 61 mm, P-712 (11°8'N, 63°18'W), 25 m depth.

*Major citations*—Redescribed in detail by Woodring, 1928; holotype illustrated by Pflug, 1961, pl. 20, figs. 1, 4).

*Addition to original description*—Shell pure white; periostracum thin, gray-green.

*Remarks*—The well-developed shoulder carina, seen in both fossil and Recent specimens, sets *P. barretti* aside from all other known Atlantic *Polystira* species. The Recent specimen illustrated here is similar to the illustration of the holotype in Pflug (1961).

*Fossil distribution*—Gurabo formation, Santo Domingo; Bowden formation, Jamaica.

*Recent distribution*—Off the Colombian and Venezuelan coasts, 20–40 m depth.

Subfamily Clavinae Powell, 1942  
Genus *Agladrillia* Woodring, 1928

39. *Agladrillia lassula* Jung, 1969  
Figs. 109–110

*Agladrillia lassula* Jung, 1969: 550–551, pl. 59, figs. 1–3.

*Material examined*—Length 25 mm, trawled by commercial shrimp boat, from 35 m depth, in Golfo de Triste, Venezuela, March, 1979, USNM 784474.

*Additions to original description*—Shell color pale tan with white axial costae; outer lip white; interior of aperture tan; early whorls pinkish-tan.

*Remarks*—The Recent specimen of *A. lassula* from the Golfo de Triste is very close to the fossil illustrated by Jung (1969, pl. 59, figs. 2, 3). The conspicuous lateral hump, which marks the termination of the axial costae and the beginning of the smooth dorsum, is a specific character seen in both the fossil and Recent specimens. There are no known Recent species of *Agladrillia* that bear any resemblance to this rather aberrant turrid, and this is the first known Atlantic species of the formerly paciphilic genus.

*Fossil distribution*—Melajo Clay Member, Springvale formation, Trinidad.

*Recent distribution*—Known only from the Golfo de Triste, Venezuela.

Genus *Hindsiclava* Hertlein & Strong, 1955

40. *Hindsiclava consors* (Sowerby, 1850)  
Figs. 111–112

*Pleurotoma consors* Sowerby, 1850: 50.

*Turris (Crassispira) consors*, Rutsch, 1934: 99, pl. 8, figs. 13–16.

*Crassispira consors*, Pflug, 1961: 67, pl. 19, figs. 4, 7, 10. Jung, 1965: 565, pl. 76, figs. 14, 15.

*Crassispira (Hindsiclava) consors consors*, Woodring, 1970: 378–380, pl. 58, figs. 1, 22.

*Material examined*—Length 38 mm, trawled by commercial shrimp boat, 35 m depth, in Golfo de Triste, Venezuela, March, 1979, USNM 784476.

*Major citations*—Lectotype illustrated by Pflug, 1961; detailed redescription and diagnosis by Woodring, 1970.

*Additions to original description*—Shell color pale yellow; subsutural band white.

*Remarks*—The Recent specimen illustrated here is nearly identical to the fossil lectotype illustrated by Pflug (1961, pl. 19, figs. 4, 10). The only other southern Caribbean *Hindsiclava* species that could be confused with *H. consors* is *H. chazaliei* (Dautzenberg, 1900) (Fig. 123) from off Surinam, Venezuela, and Colombia. The sympatric *H. chazaliei* differs from *H. consors* by having a lower spire and raised axial costae, and being dark brown in color.

*Fossil distribution*—Gurabo formation, Santo Domingo; Bowden formation, Jamaica; Springvale formation, Trinidad; Punta Gavilán formation, Venezuela; Limón formation, Costa Rica; Gatun formation, Costa Rica and Panamá.

*Recent distribution*—Known only from the Golfo de Triste, Venezuela, 35 m depth.

Subfamily Turriculinae Powell, 1942  
Genus *Fusiturricula* Woodring, 1928

41. *Fusiturricula acra* (Woodring, 1970)  
Figs. 113–114

*Pleurofusua acra* Woodring, 1970: 367–368, pl. 57, fig. 8.

*Material examined*—Length 34 mm, P-727 (10°20'N, 65°2'W), 64 m depth.

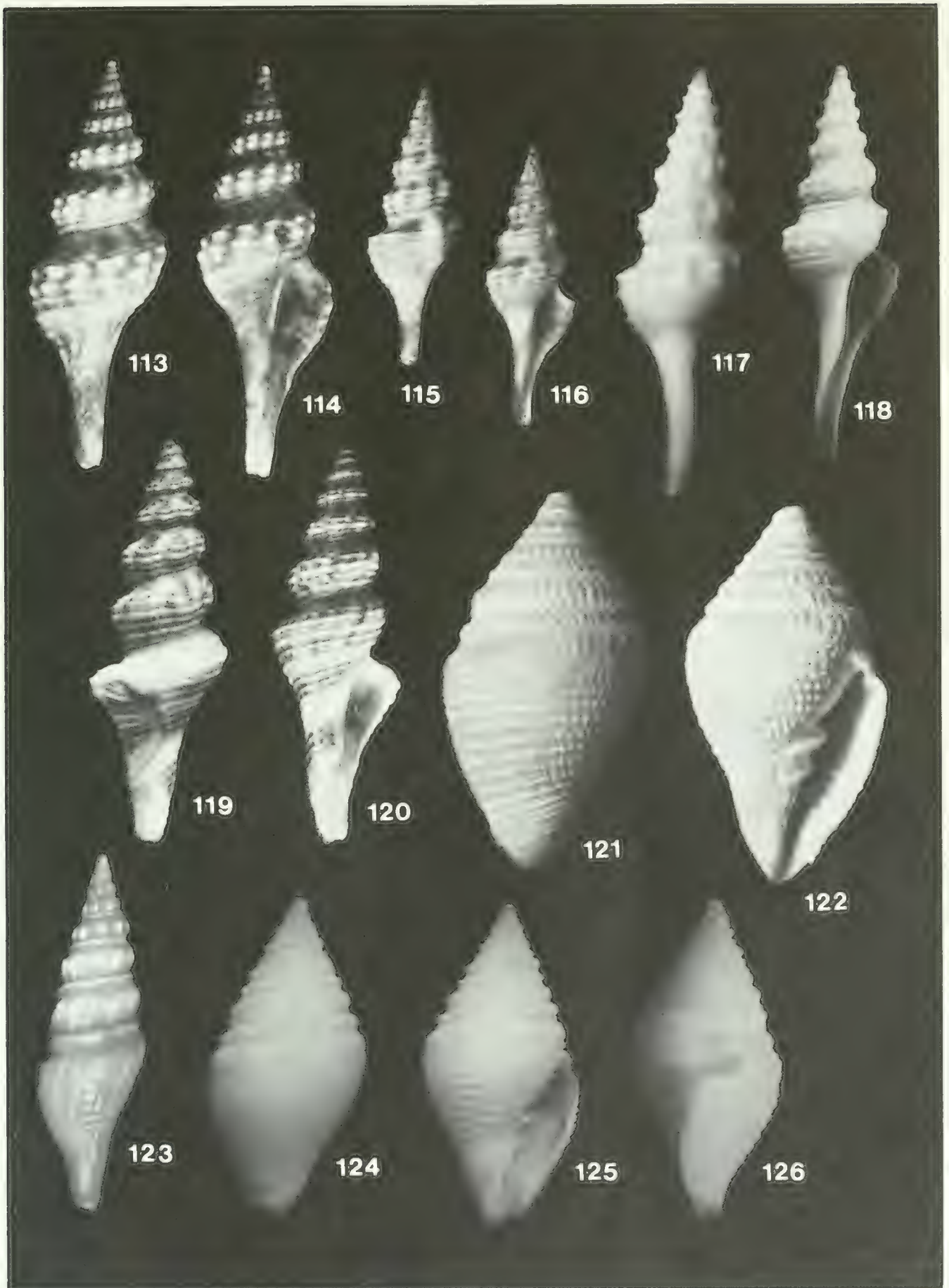

FIGS. 113–126. 113–114. *Fusiturricula acra* (Woodring): P-727, L = 34 mm. 115–116. *Fusiturricula humerosa* (Gabb): P-737, L = 19 mm. 117–118. *Fusiturricula iole* Woodring: USNM 784580, L = 17 mm. 119–120. *Fusiturricula jaquensis* (Sowerby): USNM 784475, L = 46 mm. 121–122. *Paraborsonia varicosa* (Sowerby): USNM 784581, L = 16 mm. 123. *Hindsiclava chazaliei* (Dautzenberg): P-712, L = 33 mm. 124–126. *Paraborsonia varicosa* (Sowerby): USNM 784581, L = 15 mm.

*Additions to original description*—Shell color tan with numerous thin brown vertical flammules; subsutural nodes white, separated by brown patches.

*Remarks*—*Fusiturricula acra* can be separated from the other three living northern South American *Fusiturricula* species by having white subsutural shoulder nodes and noded spiral threads on the lower part of the body whorl. This last character was used by Woodring (1970: 368) to separate *F. acra* from its fossil congeners.

*Fossil distribution*—Gatun formation, Panamá.

*Recent distribution*—Near Isla Margarita, Venezuela, 64 m depth.

42. *Fusiturricula humerosa* (Gabb, 1873)  
Figs. 115–116

*Turris (Surcula) humerosa* Gabb, 1873: 208.

*Surcula humerosa*, Pilsbry, 1922: 315–316, pl. 17, figs. 4, 5.

*Material examined*—Two specimens, lengths 15 mm and 19 mm, P-737 (10°44'N, 66°7'W), 65 m depth.

*Major citations*—Redescribed and illustrated with diagnosis by Pilsbry, 1922.

*Addition to original description*—Shell color pale tan with alternating lavender purple vertical flammules; raised spiral cords pale yellow; siphonal canal orange; interior of aperture tan; protoconch and early whorls orange.

*Remarks*—Although similar in size to the following species, *Fusiturricula humerosa* differs from *F. iole* in being a more colorful shell with a pattern of vertical purple flammules and by having a large, angled axial swelling on the dorsum of the last whorl. The specimens illustrated by Pilsbry closely resemble the specimen shown here.

*Fossil distribution*—Gurabo formation, Santo Domingo.

*Recent distribution*—Off Cabo Cordera, Venezuela, 65 m depth.

43. *Fusiturricula iole* Woodring, 1928  
Figs. 117–118

*Fusiturricula iole* Woodring, 1928: 167, pl. 6, fig. 4.

*Material examined*—Two specimens, lengths 17 mm and 20 mm, trawled by commercial shrimp boats from 35 m depth in

Golfo de Triste, Venezuela, March, 1979, USNM 784580.

*Addition to original description*—Shell pure white.

*Remarks*—*Fusiturricula iole* can be separated from both *F. acra* and *F. humerosa* by its smaller size, more angled shoulder, sharp shoulder coronations, and pure white color. The Recent specimen illustrated here is very close to the fossil holotype illustrated by Woodring.

*Fossil distribution*—Bowden formation, Jamaica.

*Recent distribution*—Golfo de Triste, Venezuela, 35 m depth.

44. *Fusiturricula jaquensis* (Sowerby, 1850)  
Figs. 119–120

*Pleurotoma jaquensis* Sowerby, 1850: 51.

*Knefastia jaquensis*, Woodring, 1928: 167.

*Fusiturricula jaquensis*, Jung, 1965: 568, pl. 77, fig. 5. Abbott, 1974: 264, no. 2918.

Altena, 1975: 62–63, pl. 4, figs. 8, 9.

*Knefastia paulettae* Princz, 1980: 71, fig. 1.

*Material examined*—Length 46 mm, trawled by commercial shrimp boats, 35 m depth, in Golfo de Triste, Venezuela, March, 1979, USNM 784475.

*Major citations*—Living specimens described by Altena, 1975 and Princz, 1980 (as *Knefastia paulettae*).

*Remarks*—*Fusiturricula jaquensis* was the first supposedly extinct Gatunian species to be recognized as part of the Recent molluscan fauna of northern South America. The specimen illustrated here is nearly identical to those illustrated by Altena (living) and Jung (fossil).

*Fossil distribution*—Bowden formation, Jamaica; Gurabo formation, Santo Domingo; Cantaure and Punta Gavilán formations, Venezuela.

*Recent distribution*—Surinam to Golfo de Triste, Venezuela, at depths of 35–100 m.

Subfamily Borsoninae Bellardi, 1875  
Genus *Paraborsonia* Pilsbry, 1922

Like *Panamurex* and *Conomitra*, this endemic American genus was presumed to have died out at the end of the Miocene (Woodring, 1970: 373). The discovery of this distinctive relict genus further reinforces the archaic nature of the upwelling faunal pocket.



45. *Paraborsonia varicosa* (Sowerby, 1850)  
Figs. 121–122, 124–126

*Mitra varicosa* Sowerby, 1850: 46.  
*Cordiera varicosa*, Gabb, 1873: 270.  
*Borsonia (Paraborsonia) varicosa*, Pilsbry,  
1922: 325–326, pl. 17, figs. 19–21.

*Materials examined*—Five specimens, lengths 14 mm to 16 mm, trawled from 35 m depth in Golfo de Triste by commercial shrimp boats, March, 1979, USNM 784581.

*Major citations*—Diagnosis and illustrations, especially of protoconch, by Pilsbry, 1922.

*Additions to original description*—Shell color pale yellow with darker yellow crescent-shaped flammules along shoulder; anterior tip of columella dark yellow; interior of aperture white.

*Remarks*—The Recent specimens of this relict genus closely resemble the specimen of *Paraborsonia varicosa* illustrated by Pilsbry. *Paraborsonia cantaurana* Jung, 1965 from the Cantaure formation of Venezuela is similar but differs in having a much higher spire, approaching the genus *Scobinella*. *Paraborsonia laeta* Jung, 1971 from the Grand Bay formation of Carriacou is also similar to the relict but has a much more developed shoulder carina.

*Fossil distribution*—Bowden formation, Jamaica; Grand Bay formation, Carriacou; Gurabo formation, Santo Domingo.

*Recent distribution*—Golfo de Triste, Venezuela, 35 m depth.

#### ACKNOWLEDGEMENTS

To my former major professor, Dr. Gilbert L. Voss of the Rosenstiel School of Marine and Atmospheric Sciences, University of Miami, I extend my most heartfelt thanks for the input into and support of my research. For critical review of the manuscript, I would like to thank the following: Dr. Donald R. Moore, Dr. Lowell P. Thomas, Dr. Peter L. Lutz, and Mr. Robert C. Work, also of the Rosenstiel School; and Dr. Richard S. Houbriek, Department of Mollusks, National Museum of Natural History, Smithsonian Institution. To Dr. Geerat J. Vermeij, Department of Zoology, University of Maryland, I give special thanks for the sharing of insights into the evolutionary history of the western Atlantic and for helping to crystallize my concept of Caribbean zoogeography.

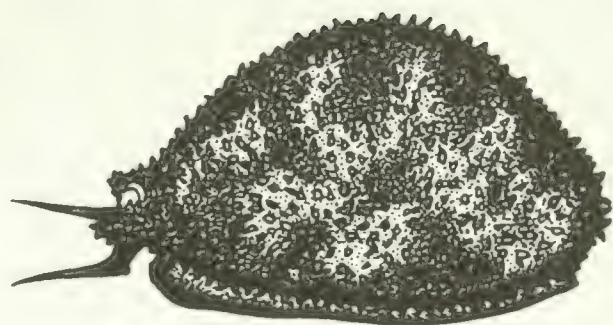

127

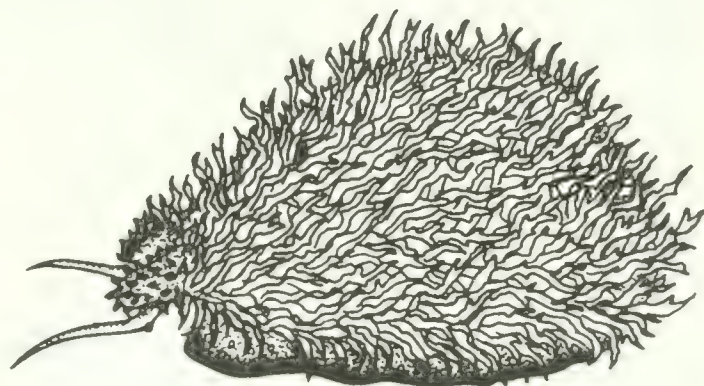

128

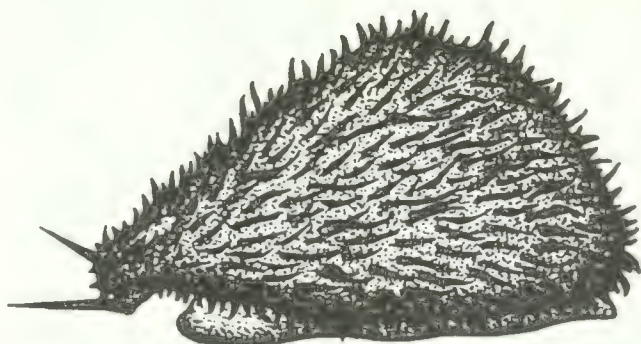

129

FIGS. 127–129. Living animals of the extant Southern Caribbean *Siphocypraea* spp., drawn from life: 127. *Siphocypraea mus* (Linnaeus). 128. *Siphocypraea donmoorei* Petuch. 129. *Siphocypraea henekeni* (Sowerby).

My deepest gratitude is extended to Dr. Jack and Mrs. Winifred Gibson-Smith, Caracas, Venezuela, who not only nursed me through a bout of Dengue Fever during a research trip to Venezuela in 1979, but also generously shared their extensive knowledge of the fossil record of Venezuelan mollusks and graciously donated much valuable study material. Thanks also go to Dr. Pablo



FIG. 130. Map of Southern Caribbean, showing distribution of upwelling system along northern Colombian and Venezuelan coasts. Actual upwelling areas denoted by heavy stippling; areas influenced by upwellings denoted by light stippling. After Meyer (1977, fig. 1).

Penchaszadeh, Universidad Simón Bolívar, Caracas, Venezuela, for his donation of research material. For loan of seemingly unobtainable but much-needed literature, I extend my sincerest thanks to Dr. William K. Emerson, Department of Invertebrates, American Museum of Natural History, New York.

Special thanks also go to Mr. Gonzalo Cruzat of Miami, Florida, Mr. Pat Izzo, University of Maryland, and Mrs. Sally D. Kaicher of St. Petersburg, Florida, for the excellent photographs.

Finally, my deepest appreciation goes to Mr. M. G. Harasewych, College of Marine Studies, University of Delaware, for his help in collecting specimens of the relicts in Venezuela in 1979, and for sharing my enthusiasm for the unexplored southern Caribbean biota.

Most of this work was done at the Rosenstiel School of Marine and Atmospheric Sciences, University of Miami, as partial fulfillment of the degree of Doctor of Philosophy in Marine Biology.

#### LITERATURE CITED

- ABBOTT, R. T., 1974, *American seashells*. Ed. 2. Van Nostrand Reinhold, New York, p. 264, no. 2918.
- ALTENA, C. O. VAN R., 1975, The marine Mollusca of Suriname (Dutch Guiana), Holocene and Recent, Part III, Gastropoda and Cephalopoda. *Zoologische Verhandelingen, Leiden*, 139: 104 p., 11 pl.
- BAYER, F. M., 1971, New and unusual mollusks collected by the R/V JOHN ELLIOTT PILLSBURY and R/V GERDA in the tropical western Atlantic. *Bulletin of Marine Science*, 21: 111-236.
- BROWN, A. P. & PILSBRY, H. A., 1911, Fauna of the Gatun Formation, Isthmus of Panama. *Proceedings of the Academy of Natural Sciences of Philadelphia*, 64: 336-373, pl. 22-29.
- BULLIS, H. R., Jr., 1964, Muricidae (Gastropoda) from the northeast coast of South America, with descriptions of four new species. *Tulane Studies in Zoology*, 11: 99-107, 1 pl.
- CLENCH, W. J., 1942, The genus *Conus* in the western Atlantic. *Johnsonia*, 1(6): 1-40, 15 pl.
- CLENCH, W. J., 1944, The genera *Casmaria*, *Galeodea*, *Phalium*, and *Cassis* in the western Atlantic. *Johnsonia*, 1(16): 1-16, 8 pl.
- CLENCH, W. J., 1947, The genera *Purpura* and *Thais* in the western Atlantic. *Johnsonia*, 2: 61-92, 8 pl.
- CLENCH, W. J., 1953, The genus *Conus* in the western Atlantic. *Johnsonia*, 2: 363-376, 5 pl.
- CLENCH, W. J., 1959, The genus *Murex* in the western Atlantic. *Johnsonia*, 3: 331-334, 2 pl.
- CLENCH, W. J. & PÉREZ FARFANTE, I. 1945, The genus *Murex* in the western Atlantic. *Johnsonia*, 1(17): 1-58, 29 pl.
- COSEL, R. VON 1976, Contribución al conocimiento del genero *Voluta* Linné, 1758 (Proso-

- branchia) en la costa del Caribe de Colombia. *Instituto Colombo-Alemán Investigaciones Científicas*, 8: 83–104, 5 pl.
- DALL, W. H., 1889, A preliminary catalogue of the shell-bearing marine mollusks and brachiopods of the southeastern coast of the United States, with illustrations of many of the species. *Bulletin of the United States National Museum*, 37: 221 p., 74 pl.
- DAUTZENBERG, P., 1900, Croisières du yacht "Chazalie" dans l'Atlantique. Mollusques. *Mémoire de la Société Zoologique de France*, 13: 145–265.
- FLORES, C., 1966, La familia Cassidae (Mollusca: Mesogastropoda) en las costas nororientales de Venezuela. *Boletín del Instituto de Oceanografía de la Universidad del Oriente*, 5(1–2): 7–37.
- FLORES, C., 1973a, La familia Littorinidae (Mollusca: Mesogastropoda) en las aguas costeras de Venezuela. *Boletín del Instituto de Oceanografía de la Universidad del Oriente*, 12(1): 3–22, 3 pl.
- FLORES, C., 1973b, Notas sobre la distribución horizontal y vertical de los Littorinidae (Mollusca: Gastropoda) en las aguas costeras de Venezuela. *Boletín del Instituto Oceanografía de la Universidad del Oriente*, 12(1): 67–74.
- GABB, W., 1860, Description of some new Tertiary fossils from Chiriqui, Central America. *Proceedings of the Academy of Natural Sciences of Philadelphia*, 12: 567–569.
- GABB, W., 1873, Description of some new genera of Mollusca. *Proceedings of the Academy of Natural Sciences of Philadelphia*, 24: 270–274, pl. 9–11.
- GABB, W., 1875, Notes on West Indian fossils. *Geological Magazine*, 2: 544–545.
- GABB, W., 1881, Descriptions of Caribbean Miocene fossils. *Journal of the Academy of Natural Sciences of Philadelphia*, 8: 337–348.
- GARDNER, J., 1937, The Molluscan fauna of the Alum Bluff Group of Florida. Part VI. Pteropoda, Opisthobranchia, and Ctenobranchia (in part). *United States Department of the Interior Geological Survey Professional Paper 142-F*: 251–435, pl. 37–48.
- GERTMAN, R. L., 1969, Cenozoic Typhinae (Mollusca: Gastropoda) of the western Atlantic region. *Tulane Studies Geology and Paleontology*, 7: 143–191, 8 pl.
- GIBSON-SMITH, J., 1973, The genus *Voluta* (Mollusca: Gastropoda) in Venezuela, with description of two new species. *Geos*, 20: 65–73, 3 pl.
- GIBSON-SMITH, J., 1976, A new taxon in the genus *Charonia* (Mollusca: Gastropoda) from the Pliocene of Venezuela. *Asociación Venezolano de Geología, Minas, y Petróleo, Boletín Informativo*, 19(1): 1–17, 1 pl.
- GIBSON-SMITH, J. & GIBSON-SMITH, W., 1974, The genus *Strombina* (Mollusca: Gastropoda) in Venezuela, with description of a new Recent and some fossil species. *Asociación Venezolano de Geología, Minas, y Petróleo, Boletín Informativo*, 17(4–6): 49–70, 4 pl.
- GIBSON-SMITH, J. & GIBSON-SMITH, W., 1979, The genus *Arcinella* (Mollusca: Bivalvia) in Venezuela and some associated faunas. *Geos*, 24: 11–32.
- GONZALEZ, A. R. & FLORES, C., 1972, Nota sobre los generos *Thais* Röding, *Purpura* Bruguière, y *Murex* Linnaeus (Neogastropoda: Muricidae) en las aguas costeras de Venezuela. *Boletín del Instituto de Oceanografía de la Universidad del Oriente*, 11(2): 67–82, 11 figs.
- GUPPY, R. J. L., 1866, On the Tertiary Mollusca of Jamaica. *Quarterly Journal of the Geological Society of London*, 22: 281–295, pl. 16–18.
- GUPPY, R. J. L., 1873, On some new Tertiary fossils from Jamaica. *Proceedings of the Scientific Association of Trinidad*, 2: 72–88. Reprint in *Bulletins of American Paleontology*, 8(35): 204–220.
- GUPPY, R. J. L., 1909, On a collection of fossils from Springvale near Couva, Trinidad. *Agricultural Society of Trinidad and Tobago Scientific Paper*, 440: 1–55. Reprint in *Bulletins of American Paleontology*, 8(35): 292–305.
- GUPPY, R. J. L., 1911, Fossils from Springvale near Couva, Trinidad, Second report. *Agricultural Society of Trinidad and Tobago Paper*, 454: 1–15. Reprint in *Bulletins of American Paleontology*, 8(35): 306–314.
- HODSON, F., 1926, Venezuelan and Caribbean Turritellas; with a list of Venezuelan type stratigraphic localities. *Bulletins of American Paleontology*, 11(45): 31, pl. 21, figs. 2, 7.
- HODSON, F. & HODSON, H. K., 1931, Some Venezuelan mollusks, Part 1. *Bulletins of American Paleontology*, 16: 1–94, 24 pl.
- HOERLE, S. E. & VOKES, E. H., 1978, A review of the volutid genera *Lyria* and *Falsilyria* (Mollusca: Gastropoda) in the Tertiary of the western Atlantic. *Tulane Studies in Geology and Paleontology*, 14: 105–130.
- INGRAM, W. M., 1939, New fossil Cypraeidae from the Miocene of the Dominican Republic. *Bulletins of American Paleontology*, 24: 327–340, pl. 22.
- INGRAM, W. M., 1940, Two new Cypraeas from Costa Rica. *Journal of Paleontology*, 14: 505–506.
- INGRAM, W. M., 1947a, New fossil Cypraeidae from Venezuela and Colombia. *Bulletins of American Paleontology*, 31: 1–12, 2 pl.
- INGRAM, W. M., 1947b, New fossil Cypraeidae from the Miocene of Florida and Colombia. *Proceedings of the California Academy of Sciences*, ser. 4, 26: 125–133, pl. 2, figs. 1–2.
- JUNG, P., 1965, Miocene Mollusca from the Paraguaná Peninsula, Venezuela. *Bulletins of American Paleontology*, 49: 384–652, pl. 50–79.
- JUNG, P., 1969, Miocene and Pliocene mollusks from Trinidad. *Bulletins of American Paleontology*, 55: 289–657, pl. 13–60.
- JUNG, P., 1971, Fossil mollusks from Carriacou,

- West Indies. *Bulletins of American Paleontology*, 61: 1–262, 21 pl.
- KAUFMANN, R. & GÖTTING, K.-J., 1970, Proso-branchia aus dem Litoral der Karibischen Küste Kolumbiens. *Helgoländer wissenschaftliche Meeresuntersuchungen*, 21: 333–398, 148 figs.
- MARKS, J. G., 1951, Miocene stratigraphy and paleontology of southwestern Ecuador. *Bulletins of American Paleontology*, 33: 142, pl. 9, figs. 10, 11.
- MAURY, C. J., 1912, A contribution to the paleontology of Trinidad. *Proceedings of the Academy of Natural Sciences of Philadelphia*, 64: 132–134.
- MAURY, C. J., 1917, Santo Domingo type sections and fossils. *Bulletins of American Paleontology* 5(29): part 1, Mollusca: 165–415, pl. 29–65.
- MAURY, C. J., 1925, A further contribution to the paleontology of Trinidad. (Miocene Horizons). *Bulletins of American Paleontology* 10: 159–402.
- MEYER, G. B., 1977, Algas marinas bénticas indicadoras de un area afectada por aguas de surgencia frente a la costa Caribe de Colombia. *Anales del Instituto Marino de Punta Betín* 9:45–71, 1 fig.
- OLSSON, A. A., 1922, The Miocene of northern Costa Rica with notes on its general stratigraphic relations Part 1. *Bulletins of American Paleontology*, (6): 42–55, 3 pl.
- OLSSON, A. A., 1942, Tertiary and Quaternary fossils from the Burica Peninsula of Panamá and Costa Rica. *Bulletins of American Paleontology*, 27: 1–106, 12 pl.
- OLSSON, A. A., 1964, *Neogene mollusks from northwestern Ecuador*. Paleontological Research Institute, Ithaca, New York, p. 1–256, 38 pl.
- OLSSON, A. A., 1965, A review of the genus *Voluta* and the description of a new species. *Bulletins of American Paleontology*, 49: 655–671, pl. 80–83.
- PERRILLIAT-MONTOYA, M. C., 1963, Moluscos de la Formación Agueguexquite (Mioceno Medio) del Istmo de Tehuantepec, Mexico. *Paleontología Mexicana*, 14: 1–45, 6 pl.
- PETIT, R. E., 1976, Notes on Cancellariidae (Mollusca: Gastropoda)—III. *Tulane Studies in Geology and Paleontology*, 12: 33–43, 2 pl.
- PETUCH, E. J., 1976, An unusual molluscan assemblage from Venezuela. *Veliger*, 18: 322–325, 1 pl.
- PETUCH, E. J., 1979, A new species of *Siphocypraea* (Gastropoda: Cypraeidae) from northern South America with notes on the genus in the Caribbean. *Bulletin of Marine Science*, 29: 216–225.
- PFLUG, H. D., 1961, Mollusken aus dem Tertiär von Santo Domingo. *Acta Humboldtiana*. Series Geologica et Palaeontologica No. 1. Steiner Verlag, Wiesbaden, p. 1–107, 26 pl.
- PILSBRY, H. A., 1922, Revision of W. M. Gabb's Tertiary Mollusca of Santo Domingo. *Proceedings of the Academy of Natural Sciences of Philadelphia*, 73: 305–435, pl. 16–47.
- PRINCZ, D., 1973, Moluscos gastrópodos y pelecípodos del Estado Nueva Esparta, Venezuela. *Memoria de la Sociedad de Ciencias Naturales La Salle*, 33: 169–222, 4 pl.
- PRINCZ, D., 1980, Los moluscos marinos del Golfo de Venezuela. *Fundación La Salle de Ciencias Naturales Contribución*, 78: 51–75.
- RADWIN, G. E. & D'ATTILIO, A., 1976, *Murex shells of the world; an illustrated guide to the Muricidae*. Stanford University Press, Stanford, California, xi + 284 p.
- REHDER, H. A., 1962, Contribución al conocimiento de los moluscos marinos del Archipelago de los Roques y La Orchila. *Memoria de la Sociedad de Ciencias Naturales La Salle*, 22: 116–138.
- RUTSCH, R., 1934, Die Gastropoden aus dem Neogen der Punta Gavilán in Nord-Venezuela. *Mémoire de la Société Paleontologique Suisse*, 54–55: 1–169, 9 pl.
- RUTSCH, R., 1942, Die mollusken der Springvale-Schichten (Obermiocaen) von Trinidad (British West-Indien). *Naturforschenden Gesellschaft Basel Verhandlungen*, 54: 96–182, pl. 3–9.
- SCHILDER, F. A., 1939, Cypraeacea aus dem Tertiär von Trinidad, Venezuela, und den Antillen. *Schweizer Paleontologische Gesellschaft Abhandlungen*, 62: 1–35.
- SCHUCHERT, C., 1935, *Historical Geology of the Antillean-Caribbean Region*. Wiley, New York, p. 230–231, 252–253, 420–455, 570–591.
- SMITH, B., 1907, A contribution to the morphology of *Pyrula*. *Proceedings of the Academy of Natural Sciences of Philadelphia*, 59: 208–219, pl. 17, figs. 1–2.
- SOWERBY, G. B., I, 1850, Description of new species of fossil shells found by J. S. Heniker [sic], Esq. *Quarterly Journal of the Geological Society of London*, 6: 44–53, pl. 9–10.
- TELLO, J., 1975, Catálogo de la fauna Venezolana, vol. 8, Mollusca. *Sociedad Venezolana Ciencias Naturales*, p. 33–163.
- VERMEIJ, G., 1978, *Biogeography and adaptation*. Harvard, Cambridge, Massachusetts, p. 1–5, 216–237.
- VINK, D. L., 1977, The *Conus cedonulli* complex. *Zoologische Mededeelingen, Leiden*, 51: 79–93, 4 pl.
- VOKES, E. H., 1967a, Observations on *Murex messorius* and *Murex tryoni*, with the description of two new species of *Murex*. *Tulane Studies in Geology*, 5: 81–90, 4 pl.
- VOKES, E. H., 1967b, Cenozoic Muricidae of the western Atlantic region. Part III—*Chicoreus* (*Phyllonotus*). *Tulane Studies in Geology*, 5: 133–166, 6 pl.
- VOKES, E. H., 1968, Cenozoic Muricidae of the western Atlantic region. Part IV—*Hexaplex* and *Murexiella*. *Tulane Studies in Geology*, 6: 85–126, 8 pl.
- VOKES, E. H., 1970, Cenozoic Muricidae of the western Atlantic region. Part V—*Pterynotus* and *Poirieria*. *Tulane Studies in Geology and Paleontology*, 8: 1–50, 7 pl.

VOKES, E. H., 1971, Catalogue of the genus *Murex* Linné (Mollusca: Gastropoda): Muricinae, Ocenebrinae. *Bulletins of American Paleontology*, 61: 5-141.

VOKES, E. H., 1974, Notes on *Chicoreus* (Mollusca: Gastropoda) from the Cenozoic of the western Atlantic region, with the description of a new species. *Tulane Studies in Geology and Paleontology*, 11: 81-95, 3 pl.

VOKES, E. H., 1975, Cenozoic Muricidae of the western Atlantic region. Part VI—*Aspella* and *Dermomurex*. *Tulane Studies in Geology and Paleontology*, 11: 121-162, 6 pl.

WEISBORD, N. E., 1929, Miocene Mollusca of northern Colombia. *Bulletins of American Paleontology*, 14: 1-57, 9 pl.

WEISBORD, N. E., 1929, Miocene Mollusca of northern Colombia. *Bulletins of American Paleontology*, 42: 1-672, 48 pl.

WOODRING, W. P., 1928, Miocene mollusks from Bowden, Jamaica. *Carnegie Institution of Washington Publication* 385: 1-564, 40 pl.

WOODRING, W. P., 1957, Geology and paleontology of Canal Zone and adjoining parts of Panamá. Description of Tertiary mollusks (Gastropods: Trochidae to Turritellidae). [*United States*] *Geological Survey Professional Paper*, 306-A: 42-62, 82-84, pl. 19, figs. 8-10.

WOODRING, W. P., 1959, Geology and paleontology of Canal Zone and adjoining parts of Panamá. Description of Tertiary mollusks (Gastropods: Vermetidae to Thaididae). [*United States*] *Geological Survey Professional Paper*, 306-B: 193-202, pl. 31, figs. 6-10, pl. 32, figs. 1, 4, 6, 9.

WOODRING, W. P., 1964, Geology and paleontology of Canal Zone and adjoining parts of Panamá. Description of Tertiary mollusks (Gastropods: Columbelloidea to Volutidae). [*United States*] *Geological Survey Professional Paper* 306-C: 255-256, pl. 39, figs. 6-8; 271, 274-275, pl. 47, fig. 12; 287-288.

WOODRING, W. P., 1970, Geology and paleontology of Canal Zone and adjoining parts of Panamá. Description of Tertiary mollusks (Gastropods: Eulimidae, Marginellidae to Helminthoglyptidae). [*United States*] *Geological Survey Professional Paper*, 306-D: 344, 345-359, 373, 378, 379; pl. 56, figs. 1, 2, 3, 7, 9; pl. 57, figs. 13, 14; pl. 58, figs. 1, 22.

WORK, R. C., 1969, Systematics, ecology, and distribution of the mollusks of Los Roques, Venezuela. *Bulletin of Marine Science*, 19: 615-711.

APPENDIX 1. R/V John Elliott Pillsbury station data, arranged by area.

	Depth	Date (all July)
		1966
1. Golfo de Urabá, Colombia		
P-353 (8°13.2'N, 76°50.1'W)	30 m	11
P-361 (8°51.9'N, 76°37.2'W)	40 m	12
P-362 (8°57.5'N, 76°33.6'W)	72 m	12
2. Golfo de Morrosquillo, Colombia		
P-367 (9°31.3'N, 75°49.5'W)	40 m	13
3. Off Peninsula de Guajira, Colombia		
		1968
P-766 (12°14.3'N, 70°40.0'W)	64 m	28
P-767 (12°16.1'N, 71°03.3'W)	25 m	28
P-768 (12°33.4'N, 71°10.8'W)	65 m	28
P-772 (12°20.2'N, 71°55.1'W)	11 m	29
P-773 (12°17.0'N, 72°15.0'W)	62 m	29
4. Golfo de Venezuela, Venezuela		
P-759 (12°09.0'N, 69°57.5'W)	36 m	27
P-760 (12°15.4'N, 69°57.5'W)	62 m	27
P-761 (11°52.0'N, 70°22.0'W)	35 m	27
5. Golfo de Triste, Venezuela		
P-749 (10°37.0'N, 67°57.9'W)	59 m	25
P-750 (10°36.1'N, 68°12.6'W)	24 m	25
P-756 (11°33.1'N, 69°12.6'W)	30 m	27
P-758 (11°42.2'N, 69°40.0'W)	16 m	27
6. Off Cabo Cordera, Venezuela		
P-734 (11°01.8'N, 65°34.2'W)	65 m	22
P-736 (10°57.0'N, 65°52.0'W)	100 m	22
P-737 (10°44.0'N, 66°07.0'W)	65 m	22
7. Off Isla Margarita, Venezuela		
P-716 (11°29.0'N, 63°51.0'W)	63 m	20
P-717 (11°21.0'N, 64°10.0'W)	64 m	20
P-718 (11°22.5'N, 64°08.0'W)	60 m	20
P-721 (11°06.5'N, 64°22.5'W)	26 m	21
P-722 (11°04.0'N, 64°44.0'W)	91 m	21
P-723 (10°43.5'N, 64°16.0'W)	65 m	21
P-727 (10°20.0'N, 65°02.2'W)	64 m	21
P-728 (10°22.5'N, 65°23.0'W)	86 m	21
8. Off Peninsula de Paria, Venezuela		
P-708 (11°24.7'N, 62°40.5'W)	70 m	19
P-709 (11°08.8'N, 62°46.1'W)	46 m	19
P-712 (11°08.0'N, 63°18.0'W)	25 m	19

APPENDIX 2. List of known living caenogastropods from shallow water in the Golfo de Venezuela and Golfo de Triste, Venezuela. T = collected in Golfo de Triste; V = collected in Golfo de Venezuela; 1 = reported by Princz, 1980; 2 = records from R/V Pillsbury expedition material; 3 = reported by Vermeij (personal communication); 4 = reported by Gonzalez & Flores, 1972; 5 = personal observations; 6 = reported by Flores, 1973, a, b.

## Littorinidae

- Littorina angulifera* (Lamarck), T, 6
- Littorina* cf. *angustior* Mörch, V, 3, 5
- Littorina flava* King & Broderip, T, 5, 6
- Littorina lineata* Orbigny, T, 6
- Littorina lineolata* Orbigny, T, 6
- Littorina meleagris* (Potiez & Michaud), T, V, 1, 5, 6
- Littorina nebulosa* (Lamarck), T, V, 1, 5, 6
- Littorina tessellata* Philippi, T, V, 1
- Littorina ziczac* (Gmelin), T, V, 1, 3, 5, 6
- Nodilittorina tuberculata* (Menke), T, V, 5, 6
- Tectarius muricatus* (Linnaeus), T, V, 3, 5, 6

## Architectonicidae

- Architectonica nobilis* (Röding), T, V, 1, 2, 5

## Turritellidae

- Turritella exoleta* (Linnaeus), T, 2
- Turritella variegata* (Linnaeus), T, V, 1, 2, 5

## Cerithiidae

- Cerithium atratum* (Born), T, V, 3, 5
- Cerithium eburneum* Hwass, T, V, 3, 5

## Planaxidae

- Planaxis nucleus* (Hwass), T, V, 1, 3, 5

## Epitoniidae

- Epitonium albidum* (Orbigny), V, 1
- Epitonium lamellosum* (Lamarck), T, V, 2, 5

## Calyptraeidae

- Calyptraea centralis* (Conrad), V, 1
- Crepidula cymbaeformis* Conrad, V, 3
- Crepidula plana* Say, V, 3
- Crucibulum auricula* (Gmelin), V, 1

## Strombidae

- Strombus gigas* Linnaeus, T, V, 1, 5
- Strombus pugilis* Linnaeus, T, V, 1, 2, 5
- Strombus raninus* Gmelin, T, 5

## Naticidae

- Polinices hepaticus* (Röding), T, V, 2, 5
- Polinices lacteus* (Güldenstädt), T, V, 2, 5

## Cypraeidae

- Cypraea cinerea* Gmelin, T, V, 2, 5
- Cypraea spurca acicularis* Gmelin, T, V, 2, 5
- Cypraea zebra* Linnaeus, T, V, 2, 5
- Siphocypraea donmoorei* Petuch, V, 5
- Siphocypraea mus* (Linnaeus), V, 1, 3, 5

## Cassidae

- Cassis madagascariensis* Lamarck, V, 1
- Phalium granulatum* (Born), T, V, 1, 2, 5

## Cymatiidae

- Cymatium aquatile* Reeve, T, 5
- Cymatium krebsi* Mörch, V, 5
- Cymatium parthenopeum* (von Salis), V, 5
- Cymatium pileare* (Linnaeus), T, 5
- Distorsio clathrata* (Lamarck), T, V, 1, 5
- Distorsio macgintyi* Emerson & Puffer, V, 5

## Tonniidae

- Tonna galea* (Linnaeus), V, 1, 5

## Bursidae

- Bursa bufo* (Hwass), T, V, 2, 5

## Muricidae

- Calotrophon velero* (E. Vokes), T, V, 2, 5
- Chicoreus brevifrons* (Lamarck), V, 1, 3, 4, 5
- Dermomurex pauperculus* (C. B. Adams), V, 3
- Phyllonotus margaritensis* (Abbott), V, 1, 3, 5
- Murex donmoorei* Bullis, T, V, 2, 4, 5
- Murex messorius* Sowerby, T, V, 1, 2, 4, 5

## Thaididae

- Purpura patula* (Linnaeus), T, 4, 5
- Thais coronatum* (Lamarck), V, 5
- Thais deltoidea* (Lamarck), T, 4, 5
- Thais haemastoma floridana* Conrad, T, V, 1, 4
- Thais rustica* (Lamarck), T, 4, 5
- Thais trinitatensis* (Guppy), V, 5

## Columbellidae

- Columbella* cf. *mercatoria* (Linnaeus), T, V, 1, 3, 5
- Mazatlaniana aciculata* (Lamarck), V, 3, 5
- Nitidella laevigata* (Linnaeus), V, 3, 5
- Strombina pumilio* (Reeve), T, V, 5

## Buccinidae

- Antillophos candei* (Orbigny), T, V, 2, 5
- Pisania lauta* (Reeve), T, V, 1, 3, 5
- Pisania auritula* (Link), T, V, 1, 3, 5

## Nassariidae

- Nassarius vibex* (Say), V, 3, 5
- Pallacera guadalupensis* (Petit), V, 3, 5

## Melongenidae

- Melongena melongena* (Linnaeus), T, V, 1, 2, 3, 5

## Fasciariidae

- Latirus angulatus* (Röding), T, V, 1, 2, 5
- Latirus infundibulum* (Gmelin), T, V, 1, 2, 5
- Leucozonia nassa* (Gmelin), V, 3, 5
- Fasciolaria* cf. *tulipa* (Linnaeus), V, 1, 2, 3, 5
- Fusinus closter* Philippi, V, 1, 2, 5

## Turbinellidae

- Vasum muricatum* (Born), V, 1, 3, 5

## Olividae

- Ancilla glabrata* (Linnaeus), T, V, 1, 2, 3, 5
- Ancilla tankervillei* (Swainson), V, 2, 5
- Oliva oblonga* Marrat, V, 5
- Oliva scripta* Lamarck, V, 1, 2, 5
- Olivella perplexa* Olsson, V, 1, 5
- Olivella verreauxi* (Duclos), T, V, 1, 3, 5

## Volutidae

*Voluta musica* Linnaeus, V, 3, 5

## Marginellidae

*Persicula interruptolineata* (Megerle von Mühl-  
feld), V, 1, 5

*Persicula tessellata* (Lamarck), V, 2, 5

*Prunum glans* (Menke), V, 2, 5

*Prunum marginatum* (Born), T, V, 1, 2, 5

*Prunum prunum* (Gmelin), V, 5

*Prunum pulchrum* (Gray), V, 2, 5

## Cancellariidae

*Cancellaria reticulata* (Linnaeus), T, V, 2, 5

## Conidae

*Conus centurio* Born, T, V, 2, 5

*Conus daucus* Hwass, V, 5

*Conus mappa* Lightfoot, T, V, 5

*Conus optabilis* A. Adams, V, 2, 5

*Conus puncticulatus* Hwass, T, V, 1, 3, 5

*Conus spurius* Gmelin, T, V, 1, 2, 5

*Conus undatus* Kiener, V, 2, 5

## Terebridae

*Hastula salleana* (Deshayes), T, V, 1, 3, 5

*Paraterebra taurina* (Solander), V, 1, 5

## Turridae

*Clathrodrillia gibbosa* (Born), V, 5

*Hindsiclava chazaliei* (Dautzenberg), V, 2, 5

*Polystira barretti* (Guppy) (as "*P. albida*"), T, V,  
1, 2, 5





## LARVAL DEVELOPMENT, SETTLEMENT AND METAMORPHOSIS OF THE TROPICAL GASTROPOD *TROCHUS NILOTICUS*

Gerald A. Heslinga

*Department of Zoology, University of Hawaii, Honolulu, Hawaii 96822, U.S.A.*

### ABSTRACT

Larvae of the archaeogastropod *Trochus niloticus* Linnaeus were reared through metamorphosis in the laboratory at Palau, Western Caroline Islands (8°N, 135°E). Swimming trochophore larvae hatched 12 hr after fertilization at 27–30°C. Settlement and metamorphosis were induced by the red coralline alga *Porolithon* sp. and by a primary algal film on culture dishes. In the presence of these substrates, larval settlement began at 50–60 hr, and metamorphosis, the loss of the velar cilia, was completed as early as 3 days and as late as 8 days after fertilization. In the absence of live algal inducers, settlement occurred in 3–10 days and metamorphosis occurred in 4–21 days. Larvae were lecithotrophic and showed no evidence of ingestion of phytoplankton prior to settlement.

Unlike the free-swimming veligers of many tropical mesogastropods, *Trochus niloticus* larvae are characterized by lecithotrophy, rapid development, and limited ability to prolong the planktonic stage in the absence of a suitable settling substrate. The poor dispersal potential of this species corroborates and may explain its restricted native range in the Indo-West Pacific. It is suggested (1) that free-swimming archaeogastropod larvae are phylogenetically constrained to lecithotrophy and short planktonic lives, and (2) that high ambient temperatures act to accelerate development and restrict larval dispersal in tropical representatives of this group.

### INTRODUCTION

A planktonic larval stage in the life history of benthic marine invertebrates enhances opportunities for dispersal, colonization of new habitats, and genetic exchange (Scheltema, 1971a; Strathmann, 1974). The duration of the larval stage directly influences dispersal potential, and is thus of interest from ecological, biogeographical and evolutionary perspectives. The present paper is an experimental investigation of the larval planktonic period of *Trochus niloticus* Linnaeus, a conspicuous and economically important archaeogastropod found on Indo-West Pacific coral reefs. This is the first such study to involve any of the numerous tropical representatives of the family Trochidae.

The free-swimming veligers of tropical mesogastropods are predominantly planktotrophic, often with long pelagic stages and great capacities for dispersal (Thorson, 1946, 1961; Robertson, 1964; Scheltema, 1966, 1968, 1971a, 1971b; Struhsaker & Costlow, 1968; Crisp, 1974; Brownell, 1977). Pechenik (1980) maintains that this trend is a result of strong selection for larval longevity in tropical seas. In temperate seas, free-swimming archaeogastropod larvae are lecithotrophic with

short planktonic lives (Crofts, 1937, 1955; Fretter & Graham, 1962; Anderson, 1965; Desai, 1966; Underwood, 1972; Manly, 1976). It is thus relevant to ask whether the numerous and ecologically important tropical archaeogastropods, including the limpets, abalones, turban shells and top shells, conform to the reproductive trends set by tropical mesogastropods, or whether they are phylogenetically constrained to lecithotrophy, rapid development, and poor dispersal ability. Investigation of the larval biology of a number of tropical archaeogastropods is desirable because it will permit a comparative approach to the problem of how phylogeny, mode of development, temperature and latitude interact to determine larval life spans.

Although top shells of the family Trochidae have been frequent subjects of morphogenetic studies, there has been no experimental consideration of how environmental variables influence the timing of metamorphosis. Poor laboratory survival of trochid larvae has in some cases precluded this kind of analysis (Underwood, 1972). Moorhouse (1932) observed spawning of *Trochus niloticus* in Australia but was not successful in rearing the larvae. Attempts to produce viable *T. niloticus* larvae by fertilization of excised gametes

(Rao, 1937), injection of KCl (Smith, personal communication) or exposure to H<sub>2</sub>O<sub>2</sub> (Hillmann, personal communication) have also been unsatisfactory. Under appropriate laboratory conditions, however, *T. niloticus* spawn epidemically on a predictable monthly schedule (Heslinga & Hillmann, in press), making this species ideal for investigations of larval biology. Here I describe early development and the effects of algal substrates on metamorphosis.

## METHODS

*Trochus niloticus* collected on the outer reefs of Paiau were held in flowing seawater tanks (27–30°C) at the Micronesian Mariculture Demonstration Center. Following epidemic spawning in the tanks, fertilized eggs were dipped out in 1 liter plastic beakers. After the eggs settled the supernatant water was decanted, the eggs were rinsed twice with Millipore filtered seawater (0.45 μm pore size) and adjusted to a density of about 1 egg/10 ml. Beakers were covered with plastic wrap and kept indoors at 27–30°C. Aeration was not provided. Larvae were transferred by pipet to experimental petri dishes, or placed on depression slides for microscopic examination, measurement by ocular micrometer, or photomicrography.

Settlement experiments were conducted in 50 ml plastic petri dishes with covers. Each dish was filled with 40 ml seawater and stocked with 20 veliger larvae. Filtered seawater was used in all cultures except those calling for a raw (unfiltered) seawater regime. A stated sample size of 6, for example, refers to 6 replicate petri dish cultures containing a total of 120 larvae. Five culture regimes were tested:

### 1) Primary algal film cultures

Prior to use in experiments, petri dishes were kept for 2 weeks in unfiltered running seawater, until covered by a thin film of bacteria, diatoms, flagellates and fine filamentous green algae (hereafter called a primary algal film). Treatment A was initiated day 2, N=6; treatment B was initiated day 6, N=3; treatment C was initiated day 10, N=3.

### 2) Filtered seawater cultures

Sterile petri dishes with filtered seawater and no added substrate. Treatment D was initiated day 2; N=9.

### 3) Raw seawater cultures

Same as filtered seawater cultures, except raw (unfiltered) seawater was used. Treatment G was initiated day 2; N=3.

### 4) Coralline red alga (*Porolithon*) cultures

Fragments of live *Porolithon* were scraped from the shell of an adult *Trochus niloticus* collected on the reef margin. A sample was preserved, examined histologically, and identified to genus (Gordon et al., 1976). Live fragments were rinsed repeatedly in filtered seawater, then added to culture dishes such that the total live algal surface area was ≈ 1 cm<sup>2</sup>/dish. Treatment E was initiated day 2; N=3. Treatment F was initiated day 6; N=3.

### 5) Control substrate for coralline algae cultures

Fragments of dead, sunbleached coralline algae were collected from dried *T. niloticus* shells and boiled in fresh water. Fragments were then rinsed in filtered seawater and added to petri dishes in quantities similar to #4. Treatment H was initiated day 2; N=3.

Dishes were kept indoors at 27–30°C, away from direct sunlight. Water in each dish was changed at 2 day intervals by pipetting off 35 ml culture water and replacing it with an equal volume of filtered seawater or raw seawater, as required. Cultures were examined twice daily (AM and PM) under a dissecting microscope, and all dead or metamorphosed larvae were removed. Metamorphosis was considered complete after total loss of the velar cilia. Squash preparations of newly metamorphosed juveniles were examined for evidence of food ingestion. Cultures were terminated when all larvae had either metamorphosed or died.

## RESULTS

### Development

Eggs released by female *Trochus niloticus* were dark green and approximately 185 μm in diameter (Fig. 1A). They were surrounded by a pitted jelly layer measuring 475–500 μm across. Fertilization occurred immediately and within a few minutes the vitelline membrane rose to a diameter of about 225 μm. Cleavage began after 30 minutes and followed the typical spiral pattern (e.g. Robert, 1902). Gastrulation by epiboly occurred after 5–6 hr. By 8 hours post-fertilization, trocho-

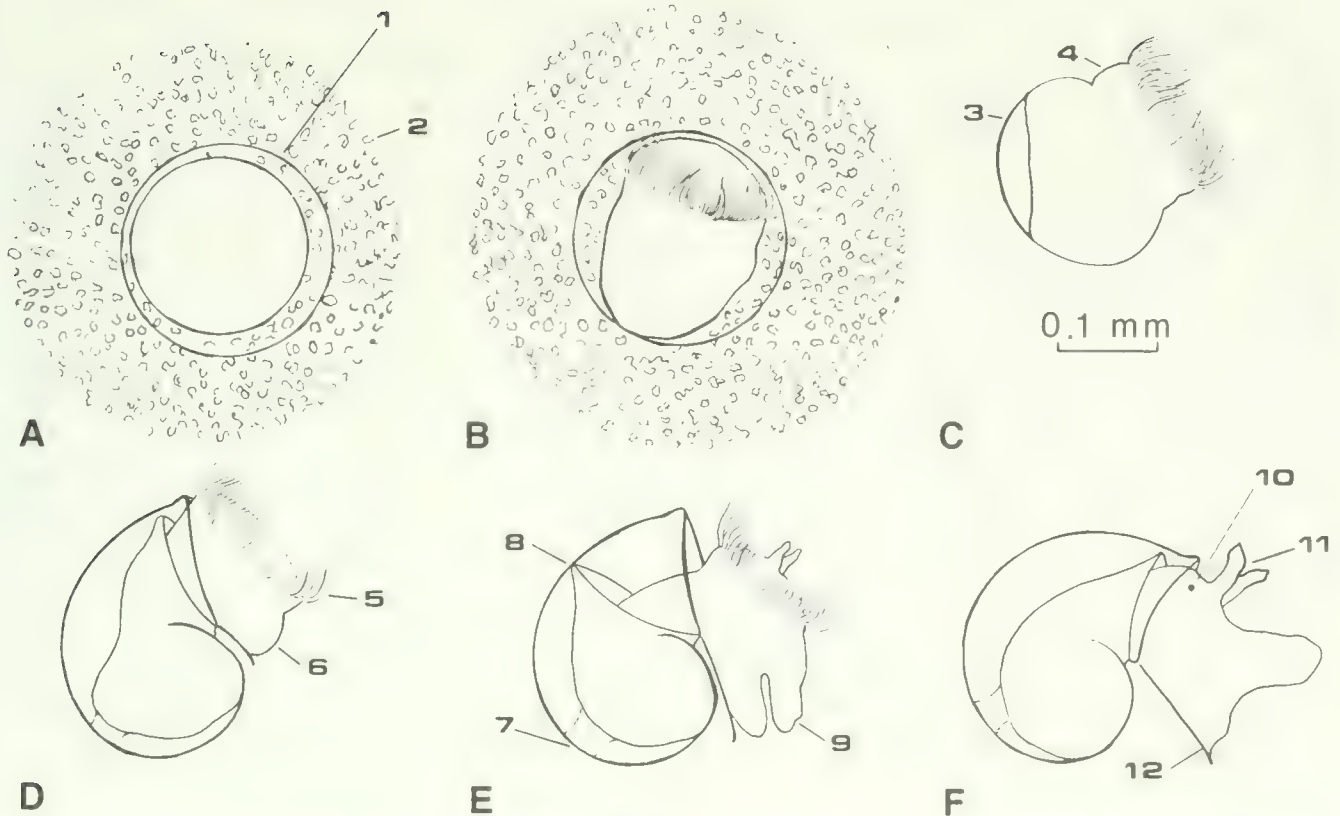

FIG. 1. Embryonic and larval *Trochus niloticus*. A, fertilized egg, time (t) = 3 minutes after fertilization; B, gastrula just before hatching, t = 11.5 hr; C, pretorsional trochophore with embryonic shell growth beginning, t = 14 hr; D, veliger with complete larval shell, after 90° torsion, t = 20 hr; E, veliger with reduced velum, t = 65 hr; F, metamorphosed juvenile, t = 73 hr. All figures drawn to same scale. 1, vitelline membrane; 2, jelly layer; 3, embryonic shell; 4, foot rudiment; 5, velum; 6, foot; 7, larval retractor muscle attachment site; 8, mantle margin; 9, propodium; 10, eye; 11, cephalic tentacles; 12, operculum.

blast cells were ciliated (Fig. 1B), and rotation of the gastrula within the vitelline membrane began after about 9 hours. Rotation was at first feeble and intermittent, but became increasingly vigorous until trochophores hatched at 12 hr. Newly hatched trochophores swam near the top few centimeters of water in 1 liter beakers, alternately rising to the surface and dropping briefly through the water column.

The embryonic shell appeared near the vegetal pole within an hour after hatching, and spread rapidly to the anterior (Fig. 1C). The first phase of torsion occurred between 14 and 18 hr, rotating the shell and visceral hump through 90° with respect to the head and foot. By 20 hr the larval shell was complete and measured approximately 290  $\mu\text{m}$  in diameter (Fig. 1D). At this point the velum was a simple circular ridge with a single band of prominent cilia. Full retraction into the larval shell was first observed at 24 hr. Larvae continued to swim near the top of the water column, but began to show negative phototaxis, swimming to the opposite side of the beaker in response to light.

In the presence of live algal substrate,

veligers began settling and creeping at 50–60 hr. Newly settled larvae probed the substrate with the tip of the propodium, frequently flexing the anterior edge of the foot and passing the propodium over the mouth. By this time the velum had developed a mid-ventral cleft, resulting in 2 distinct lobes. The lobes were gradually resorbed, revealing 2 cephalic tentacle rudiments and 2 black eye rudiments near the center of the velum. The velar lobes became progressively reduced in size and their cilia were sloughed off until only a few remained beating. The last cilia were cast from the vestigial velum at about 70 hr (Fig. 1F). The larval shell had not increased in size since its completion at 20 hr.

#### Induction of metamorphosis

Mean survival through metamorphosis in all petri dish cultures was 91% (range: 75–100%), with 8 of 33 cultures exhibiting 100% survival. Mortalities were not clearly associated with any particular stage of development. In filtered seawater cultures with no algal substrate, metamorphosis occurred on days 4–

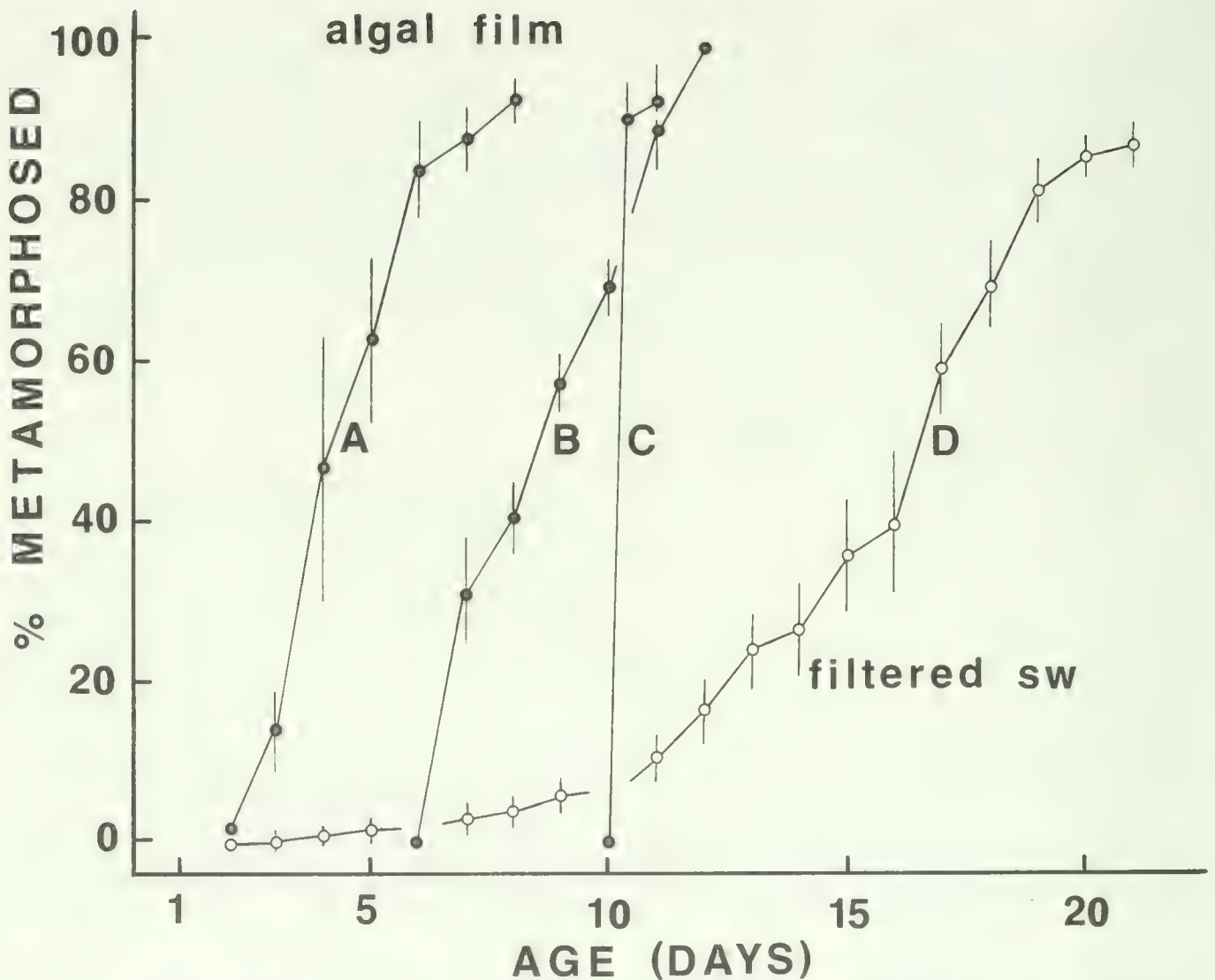

FIG. 2. Metamorphosis of *Trochus niloticus* larvae in response to a primary algal film on culture dishes. Treatments were initiated on day 2 (A), day 6 (B), and day 10 (C). Treatment D is filtered seawater control with no algal film. Points are means  $\pm 1$  S.E. A, N = 6 replicate cultures, each containing 20 larvae; B, N = 3; C, N = 3; D, N = 9.

21, and was completed by 50% of the larval population by days 16–17 (Fig. 2D). Among larvae that had not metamorphosed by day 8, the velum became conspicuously reduced in size and the digestive gland became increasingly transparent as the yolk supply diminished. By day 10, 100% settlement had occurred among unmetamorphosed larvae, and from day 10–21 creeping was the mode of locomotion. During this creeping period the velar cilia continued to beat sporadically but no further swimming was observed.

Larvae exposed to a primary algal film beginning on the 2nd, 6th or 10th day metamorphosed earlier than those reared with no algal substrate (Fig. 2). When algal film exposure was initiated on day 2, 14% of the larval population metamorphosed by day 3, 50% metamorphosed by days 4–5, and 93% metamorphosed by day 8 (Fig. 2A). When

algal film exposure was initiated on day 6, 32% of the larval population metamorphosed by day 7, 50% metamorphosed by days 8–9, and 100% metamorphosed by day 12 (Fig. 2B). The most rapid response to algal film was shown by the oldest larvae. When this treatment was initiated on the morning of day 10, 91% of the larval population metamorphosed within 10 hours (Fig. 2C). In contrast, mean percent metamorphosis in filtered seawater cultures with no algal substrate remained below 10% through day 10; in 3 of 9 replicates no metamorphosis occurred until day 11 (Fig. 2D). These results suggest that the algal films induced metamorphosis in *Trochus niloticus* larvae and that the intensity of response was age dependent.

Fragments of live *Porolithon* introduced on day 2 or day 6 caused metamorphic responses similar to those caused by a primary

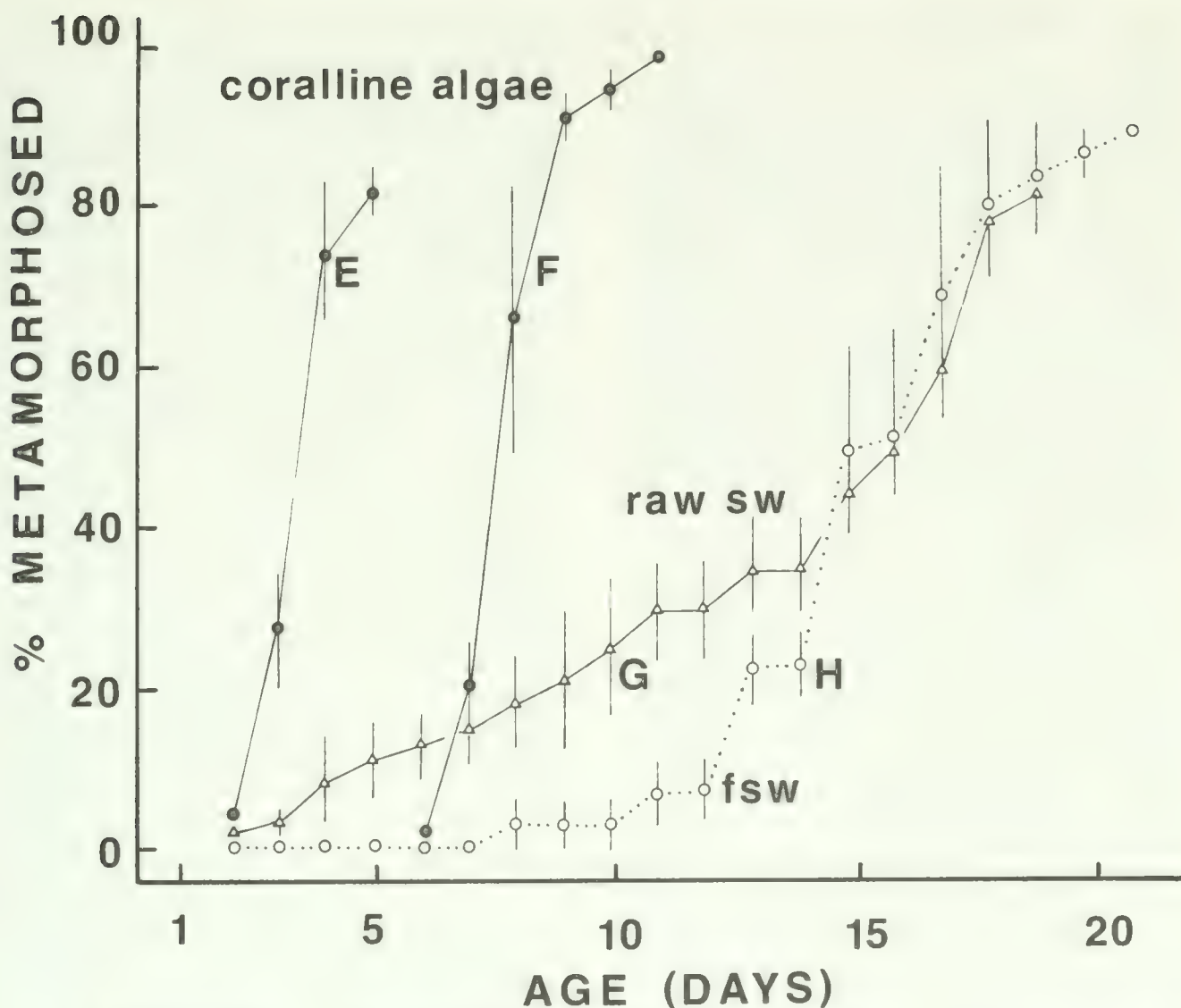

FIG. 3. Metamorphosis of *Trochus niloticus* larvae in response to living fragments of the coralline red alga *Porolithon* sp., introduced on day 2 (E) and day 6 (F). Treatment G is raw unfiltered seawater with no added substrate. Treatment H is filtered seawater control with dead, sterile fragments of coralline algae. Points are means  $\pm 1$  S.E.  $N = 3$  for all treatments.

algal film (Figs. 3E, 3F). In both cases where live *Porolithon* was introduced, 20–30% of the larval population metamorphosed within 24 hr, while the remaining individuals metamorphosed during the next 2–4 days. Non-quantitative behavioral observations indicated that larvae crept and metamorphosed preferentially on the living algal fragments, and remained on or under the fragments after metamorphosing. No evidence of food ingestion prior to settlement was found among larvae exposed to a primary algal film or to *Porolithon* fragments.

Larvae reared in dishes containing boiled coralline algae fragments showed no apparent attraction to the fragments after settling. No metamorphosis occurred in these cultures until day 8, after which the response curve resembled that of larvae reared in filtered seawater with no algal substrate (Fig. 3H).

Metamorphosis of larvae reared in raw seawater began on day 3 and was completed by day 19 (Fig. 3G). Despite an abundance of small flagellates and diatoms in the culture water, close examination of live larvae and squash preparations showed no indication that planktonic feeding had occurred prior to settlement.

#### DISCUSSION

The family Trochidae includes species that deposit benthic egg masses and others that broadcast their spawn. *Trochus niloticus* belongs to the second category, and like previously described archaeogastropods (Fretter & Graham, 1962), hatches in the trochophore stage. Gohar & Eisawy (1963) and Eisawy (1970) reported without supporting evidence

that *T. niloticus* hatches as a free swimming veliger.

The gross features of development in *Trochus niloticus* appear similar to those of *T. dentatus*, described in detail by Eisawy (1970). *T. niloticus* eggs are similar in size to those of *T. dentatus*, but differ in that they are surrounded by a conspicuous pitted jelly layer. In the temperate water trochids *Mono-donta lineata* and *Gibbula cineraria*, the jelly layer disperses within minutes and may act as an early block to polyspermy (Desai, 1966; Underwood, 1972). This is clearly not the function of the layer in *T. niloticus* since it does not inhibit fertilization and since it persists until hatching. The jelly layer increases the surface area of *T. niloticus* eggs by at least 500%, and in nature it would slow the sinking rate of embryos and thus reduce the risk of predation by benthic planktivores.

The minimum time required for *Trochus niloticus* larvae to metamorphose was about 3 days; in the presence of algal inducers all larvae shed the velum by day 8. Although some individuals in filtered seawater cultures retained the velar cilia until day 21, most of the larval population settled during the first week, and no swimming at all occurred after day 10. In the absence of a suitable settling substrate, velar resorption was delayed by no more than a few days. By day 10 the reduced velum is probably no longer functional as a swimming organ, even though it may retain some cilia. Anderson (1962) suggested that the velar cilia act to stabilize larval creeping in the limpet *Cellana tramoserica*. This could explain why archaeogastropod larvae often retain the velar cilia for some time after settlement. To the extent that this is true, the time of total velar cilia loss must give an overestimate of the duration of the planktonic period.

Induction of metamorphosis by organic extracts or substrates, including algal films, has been documented in a variety of marine invertebrate larvae (see Crisp, 1974, 1976; Chia & Rice, 1978). Morse et al. (1979) identified gamma-amino butyric acid and related compounds, isolated from coralline red algae, as inducers of metamorphosis in temperate water archaeogastropods of the genus *Haliotis*. It seems likely that a similar induction-response interaction occurs between *Porolithon* and the larvae of *Trochus niloticus*. *Porolithon* and other crustose coralline algae are suspected or known to induce settlement and metamorphosis in several asteroids as well (Henderson & Lucas, 1971; Yamaguchi,

1973, 1974; Lucas & Jones, 1976; Barker, 1977). Morse et al. (in press) argue that such interactions are mutually beneficial and co-evolved; larval invertebrates are induced to metamorphose on a suitable microhabitat which may also be a food source, while the inducing algae are grazed free of potentially harmful fouling epiphytes. The sensory mechanisms by which larvae perceive inducer substances are not known.

The dramatic response of *Trochus niloticus* larvae to live coralline algae and to a primary algal film on culture dishes indicates that this prosobranch is not narrowly restricted in substrate preference, as are some prey-specific or host-specific opisthobranch juveniles (Hadfield, 1977; Perron & Turner, 1977). If *T. niloticus* larvae in nature settle preferentially on red coralline algae or on algal film covered substrates, the potential space for recruitment would appear to be broad. *Porolithon* is a dominant alga on Indo-West Pacific coral reef margins, and it is also common on inner and outer reef flats (Gordon et al., 1976). *T. niloticus* juveniles are most often found near outer reef flat rubble and cobble zones (Moorhouse, 1932; McGowan, 1956; Gail & Devambe, 1958; Smith, 1979) where filamentous and encrusting algae are common and live coral cover is low. Larval settlement probably occurs here.

*Trochus niloticus* is indigenous only to the Indo-Malaysian area, Melanesia, and Yap and Palau in Micronesia (Hedley, 1917; Rao, 1937; Vermeij, 1978), but because of its economic importance the species has been introduced to several other island groups to the east, where it is now common. Successful *T. niloticus* introductions have been carried out in the Marianas (see Smith, 1979), the Caroline, Marshall and Cook Islands (Gail & Devambe, 1958), French Polynesia (Doumenge, 1972) and Hawaii (Kay, 1979). The rather restricted indigenous range may be attributable in part to the short larval life span. Before the planktonic larva of *T. niloticus* had been identified, McGowan (1958: 18) proposed that the planktonic term is "not of very long duration, otherwise *Trochus niloticus* would have bridged the gap naturally between Palau and Ngulu [ $\approx 300$  km], or Yap and Ulithi [ $\approx 200$  km], as have other species of Micronesian *Trochus*." The native range of *T. niloticus* appears to have been limited by poor larval dispersal rather than by habitat unsuitability on other tropical Pacific islands.

The larval life span of *Trochus niloticus* is significantly shorter than that of other broadcast spawning archaeogastropods from higher latitudes. *T. niloticus* metamorphosed within 3 days at 27–30°C, while the temperate trochids *Gibbula cineraria* (Underwood, 1972) and *Monodonta lineata* (Desai, 1966) required a minimum of 9 days at 12° and 7 days at 15–20°C, respectively. Three temperate acmaeid limpet species reared by Anderson (1965) metamorphosed in 7–10 days at 20°, while several temperate haliotids (Leighton, 1972, 1974) and patellids (Dodd, 1957; Anderson, 1962) metamorphosed after 1–2 weeks when reared at local ambient temperatures.

There is no evidence that temperate archaeogastropod larvae are capable of suspension feeding while swimming (Strathmann, 1978) though Crofts (1937) and Morse et al. (in press) suggested that some benthic feeding may occur between settlement and metamorphosis. If planktotrophy exists in extant archaeogastropods it should be evident in tropical species. The data presented here, however, suggest that tropical archaeogastropods are similar to their temperate counterparts in being phylogenetically constrained to lecithotrophy and short larval lives. Moreover, unless rate-compensating mechanisms exist, high tropical temperatures should accelerate development in lecithotrophic larvae and further reduce the duration of the swimming phase. These considerations may account for the limited native range of *Trochus niloticus*, and may in part explain the restricted tropical distributions of several archaeogastropod families previously noted by Kay (1967) and Vermeij (1972).

#### ACKNOWLEDGEMENTS

I am grateful to Drs. W. M. Hamner and K. Chave for advice and encouragement during the study. I thank the staff of the Micronesian Mariculture Demonstration Center, especially A. Hillmann, N. Idechong and R. Braley, for technical assistance. Drs. E. A. Kay, J. E. Bardach, M. Hadfield and F. Perron offered critical comments on the manuscript. This work was supported by grants from the Resource Systems Institute, East-West Center (Honolulu), the Hawaiian Malacological Society, the Society of Sigma Xi, and the Marine Resources Division, U.S. Trust Territory of the Pacific Islands.

#### REFERENCES CITED

- ANDERSON, D. T., 1962, The reproduction and early life histories of the gastropods *Bembicium auratum* (Quoy and Gaimard) (Fam. Littorinidae), *Cellana tramoserica* (Sower.) (Fam. Patellidae) and *Melanerita melanotragus* (Smith) (Fam. Neritidae). *Proceedings of the Linnaean Society of New South Wales*, 87: 62–82.
- ANDERSON, D. T., 1965, The reproduction and early life histories of the gastropods *Notoacmaea petterdi* (Ten.-Woods), *Chiazacmaea flammea* (Quoy and Gaimard) and *Patelloida alticostata* (Angas). *Proceedings of the Linnaean Society of New South Wales*, 90: 106–114.
- BARKER, M. F., 1977, Observations on the settlement of the brachiolaria larvae of *Stichaster australis* (Verrill) and *Coscinasterias calamaria* (Gray) (Echinodermata: Asteroidea) in the laboratory and on the shore. *Journal of Experimental Marine Biology and Ecology*, 30: 95–108.
- BROWNELL, W. N., 1977, Reproduction, laboratory culture, and growth of *Strombus gigas*, *S. costatus* and *S. pugilis* in Los Roques, Venezuela. *Bulletin of Marine Science*, 27: 668–680.
- CHIA, F. S. & RICE, M. E. (eds.), 1978, *Settlement and Metamorphosis of Marine Invertebrate Larvae*. Elsevier, New York, 290 p.
- CRISP, D. J., 1974, Factors influencing the settlement of marine invertebrate larvae. In: GRANT, P. T. & MACKIE, A. N. (ed.), *Chemoreception in Marine Organisms*. Academic Press, New York, 290 p.
- CRISP, D. J., 1976, Settlement responses in marine organisms. In: NEWELL, R. C. (ed.), *Adaptations to Environment: Essays on the Physiology of Marine Animals*. Butterworth's, London, p. 83–124.
- CROFTS, D. R., 1937, The development of *Haliotis tuberculata* with special reference to organogenesis during torsion. *Philosophical Transactions of the Royal Society of London*, ser. B, 228: 219–268.
- CROFTS, D. R., 1955, Muscle morphogenesis in primitive gastropods and its relation to torsion. *Proceedings of the Zoological Society of London*, 37: 1–17.
- DESAI, B. N., 1966, The biology of *Monodonta lineata* (da Costa). *Proceedings of the Malacological Society of London*, 37: 1–17.
- DODD, J. M., 1957, Artificial fertilization, larval development and metamorphosis in *Patella vulgata* L. and *Patella coerulea* L. *Pubblicazioni della Stazione Zoologica di Napoli*, 29: 172–186.
- DOUMENGE, F., 1972, Commercial exploitation of *Trochus* (French Polynesia). *South Pacific Commission Fisheries Newsletter*, 3: 4, 32.
- EISAWY, A. M., 1970, The spawning and development of *Trochus (Tectus) dentatus* Forskal. *Bulletin of the Institute of Oceanography and Fisheries, Cairo*, 1: 379–393.
- FRETTER, V. & GRAHAM, A., 1962, *British Prosobranch Molluscs*. Ray Society, London, 755 p.

- GAIL, R. & DEVAMBEZ, L., 1958, Selected annotated bibliography of *Trochus*. *South Pacific Commission Technical Paper*, 111: 1–20.
- GOHAR, H. A. F. & EISAWY, A. M., 1963, The egg masses and development of *Trochus (Infundibulops) erythraeus* Brocchi. *Publications of the Marine Biological Station, Al-Ghardaqa, Cairo*, 12: 191–203.
- GORDON, G. D., MASAKI, T. & AKIOKA, H., 1976, Floristic and distributional account of the common crustose coralline algae of Guam. *Micronesica*, 12: 247–277.
- HADFIELD, M. G., 1977, Chemical interactions in larval settling of a marine gastropod. In: FAULKNER, D. J. & FENICAL, W. H. (ed.), *Marine Natural Products Chemistry*. Plenum, New York, p. 403–413.
- HEDLEY, C., 1917, The economics of *Trochus niloticus*. *Australian Zoologist*, 1: 69–73.
- HENDERSON, J. A. & LUCAS, J. S., 1971, Larval development and metamorphosis of *Acanthaster planci* (Asteroidea). *Nature*, 232: 655.
- HESLINGA, G. A. & HILLMANN, A., 1981, Hatchery culture of the commercial top snail *Trochus niloticus* in Palau, Caroline Islands. *Aquaculture*, 22: 35–43.
- KAY, E. A., 1967, The composition and relationships of marine molluscan fauna of the Hawaiian Islands. *Venus*, 25: 94–104.
- KAY, E. A., 1979, *Hawaiian Marine Shells*. Bishop Museum, Honolulu, 653 p.
- LEIGHTON, D. L., 1972, Laboratory observations on the early growth of the abalone, *Haliotis sorenseni*, and the effect of temperature on larval development and settling success. *Fishery Bulletin*, 70: 373–381.
- LEIGHTON, D. L., 1974, The influence of temperature on larval and juvenile growth in three species of Southern California abalones. *Fishery Bulletin*, 72: 1137–1145.
- LUCAS, J. S. & JONES, M. S., 1976, Hybrid crown-of-thorns starfish (*Acanthaster planci* × *A. brevispinus*) reared to metamorphosis in the laboratory. *Nature*, 198: 610–611.
- MANLY, R., 1976, The larval development of *Tricolia pullus* (L.). *Journal of Molluscan Studies*, 42: 361–369.
- MCGOWAN, J. A., 1956, The current status of the *Trochus* industry in Micronesia. *Report to the High Commissioner, U.S. Trust Territory of the Pacific Islands, Saipan*, 11 p.
- MCGOWAN, J. A., 1958, The *Trochus* fishery of the Trust Territory of the Pacific Islands. *Report to the High Commissioner, U.S. Trust Territory of the Pacific Islands, Saipan*, 46 p.
- MOORHOUSE, F. W., 1932, Notes on *Trochus niloticus*. *Scientific Reports of the Great Barrier Reef Expedition, 1928–1929*, 3: 315–324.
- MORSE, D. E., HOOKER, N., DUNCAN, H. & GENSEN, L., 1979,  $\gamma$ -Aminobutyric acid, a neurotransmitter, induces planktonic abalone larvae to settle and begin metamorphosis. *Science*, 204: 407–410.
- MORSE, D. E., TEGNER, M., DUNCAN, H., HOOKER, N., TREVELYAN, G. & CAMERON, A., in press, Induction of settling and metamorphosis of planktonic molluscan (*Haliotis*) larvae. In: MULLER-SCHWARZ, D., (ed.), *Chemical Signaling in Vertebrates and Aquatic Animals*. Plenum, New York.
- PECHENIK, J. A. 1980, Growth and energy balance during the larval lives of three prosobranch gastropods. *Journal of Experimental Marine Biology and Ecology*, 44: 1–28.
- PERRON, F. E. & TURNER, R. D., 1977, Development, metamorphosis, and natural history of the nudibranch *Doridella obscura* Verrill (Corambidae: Opisthobranchia). *Journal of Experimental Marine Biology and Ecology*, 27: 171–185.
- RAO, H. S., 1937, On the habitat and habits of *Trochus niloticus* Linn. in the Andaman Seas. *Records of the Indian Museum, Calcutta*, 39: 47–82.
- ROBERT, A., 1902, Recherches sur le developement des troques. *Archives de Zoologie expérimentale et générale*, 10: 269–538.
- ROBERTSON, R., 1964, Dispersal and wastage of larval *Philippia krebsii* (Gastropoda: Architectoniciidae) in the North Atlantic. *Proceedings of the Academy of Natural Sciences of Philadelphia*, 116: 1–27.
- SCHELTEMA, R. S., 1966, Evidence for trans-Atlantic transport of gastropod larvae belonging to the genus *Cymatium*. *Deep Sea Research*, 13: 83–95.
- SCHELTEMA, R. S., 1968, Dispersal of larvae by ocean currents and its importance to the zoogeography of shoal water tropical species. *Nature*, 217: 1159–1162.
- SCHELTEMA, R. S., 1971a, Larval dispersal as a means of genetic exchange between geographically separated populations of shallow-water benthic marine gastropods. *Biological Bulletin*, 140: 284–322.
- SCHELTEMA, R. S., 1971b, The dispersal of the larvae of shoal-water benthic invertebrate species over long distances by ocean currents. In: CRISP, D. J. (ed.), *Fourth European Marine Biology Symposium*. Cambridge University, Cambridge, p. 7–28.
- SMITH, B. D., 1979, *Growth rate, abundance and distribution of the topshell Trochus niloticus on Guam*. M.S. Thesis, University of Guam, 24 p.
- STRATHMANN, R. R., 1974, The spread of sibling larvae of sedentary marine invertebrates. *American Naturalist*, 108: 29–44.
- STRATHMANN, R. R., 1978, The evolution and loss of feeding larval stages of marine invertebrates. *Evolution*, 32: 894–906.
- STRUHSAKER, J. W. & COSTLOW, J. D., 1968, Larval development of *Littorina pica* (Prosobranchia: Mesogastropoda), reared in the laboratory. *Proceedings of the Malacological Society of London*, 38: 153–160.
- THORSON, G., 1946, Reproduction and larval development of Danish marine bottom inverte-



- brates. *Meddelelser fra Kommissionen for Danmarks Fiskeri- og Havundersøgelser, ser. Plankton*, 4, 523 p.
- THORSON, G., 1961, Reproduction and larval ecology of marine bottom invertebrates as related to larval transport by ocean currents. In: SEARS, M. (ed.), *Oceanography*. American Association for the Advancement of Science, Washington, D.C., p. 455–474.
- UNDERWOOD, A. J., 1972, Spawning, larval development and settlement behavior of *Gibbula cineraria* (Gastropoda: Prosobranchia) with a reappraisal of torsion in gastropods. *Marine Biology*, 17: 341–349.
- VERMEIJ, G. J., 1972, Endemism and environment: some shore molluscs of the tropical Atlantic. *American Naturalist*, 106: 89–101.
- VERMEIJ, G. J., 1978, *Biogeography and Adaptation*. Harvard University, Cambridge, Massachusetts, 332 p.
- YAMAGUCHI, M., 1973, Early life histories of coral reef asteroids, with special reference to *Acanthaster planci* (L.). In: JONES, A. O. & ENDEAN, R. (eds.), *Biology and Geology of Coral Reefs*, Vol. 2, Biology I. Academic Press, New York, p. 367–387.
- YAMAGUCHI, M., 1974, Larval life span of the coral reef asteroid *Gomophia egyptiaca* Gray. *Micronesica* 10: 57–64.



AMERICAN MALACOLOGICAL UNION  
SYMPOSIUM: FEEDING MECHANISMS OF PREDATORY MOLLUSCS

Organized by Alan J. Kohn  
President: Clyde F. E. Roper  
Louisville, Kentucky  
24 July, 1980



FEEDING MECHANISMS OF PREDATORY MOLLUSCS:  
INTRODUCTION TO THE SYMPOSIUM

Alan J. Kohn

*Department of Zoology, University of Washington, Seattle, Washington 98195, U.S.A.*

The most important problem an animal faces in nature is obtaining a sufficient quantity of the right kind of food. An animal that fails in this endeavor soon learns the meaning of the term 'energy crisis.' The animal that solves this basic problem can at least face the other trials and tribulations of its world on a full stomach.

The goal of this Symposium was to address recent advances in understanding of how predatory molluscs detect, obtain, and ingest their prey. The Symposium focused on the feeding mechanism itself, but the presentations and discussions ranged widely over many aspects of feeding: how predators become aware that prey is nearby, the structure and functioning of mechanisms for overcoming prey organisms, and how their feeding biology affects how predatory molluscs interact with other organisms in their communities. The Symposium was held 24 July 1980, at the annual meeting of the American Malacological Union in Louisville, Kentucky.

How important is predation in the Mollusca? Is it primitive in the phylum? Although the Symposium participants did not attempt to answer these questions, they provided a heuristic framework for the discussions. If the molluscs evolved from a platyhelminth-like ancestor as many zoologists believe, the

answer to the second question is probably yes. As to the first question, all 7 classes of molluscs contain predatory representatives, and 4 are probably almost exclusively predatory. These are the Monoplacophora, Aplacophora, Scaphopoda, and Cephalopoda. Many gastropods are predatory, although this is probably a derived characteristic in this class. In the remaining two classes, Bivalvia and Polyplacophora, carnivory is uncommon and undoubtedly derived.

The class Gastropoda contains the largest number and greatest diversity of predatory molluscs. Nevertheless, it is unfortunate that only one other class could be represented in the Symposium papers. In the Introduction to an earlier A.M.U. symposium, George Davis (*Malacologia*, 1978, 17: 163) noted the predominance of studies of terrestrial gastropods as a source of "the most exciting and encompassing work in molluscan evolution over the last 15 years." The papers that follow contribute importantly to understanding the feeding biology of predatory molluscs. They also demonstrate that evolutionarily less well known taxa of molluscs have equally exciting possibilities and that examination of distinct phyletic lineages can provide independent tests of theories in evolutionary biology.



## COMPARATIVE MORPHOLOGY OF THE RADULAE AND ALIMENTARY TRACTS IN THE APLACOPHORA<sup>1</sup>

Amelie H. Scheltema

*Woods Hole Oceanographic Institution, Woods Hole, Massachusetts 02543, U.S.A.*

### ABSTRACT

The alimentary tract was studied in one genus of Neomeniomorpha and in five genera of Chaetodermomorpha.

The cuticular oral shield of the Chaetodermomorpha is part of the foregut cuticle.

A dorsal ciliated tract or typhlosole, an unarticulated radula on a radular membrane, an odontophore with bolsters within the haemocoel, and paired tubular salivary glands are conservative molluscan characters. It is not certain whether an undivided stomach-digestive gland (Neomeniomorpha) or separate stomach and digestive diverticulum (Chaetodermomorpha) represents the primitive midgut in the Aplacophora. The molluscan style may primitively have been formed throughout the stomach and anterior intestine (*Scutopus*). A style sac with protostyle and a gastric shield have evolved together independently in one family of carnivorous Aplacophora (Chaetodermatidae).

The genera studied here exhibit an evolution of the radula from rows of distichous teeth firmly affixed to a divided or fused radular membrane to (1) a gastropod-like articulated radula and (2) a highly specialized pincers-like radula. The odontophore has evolved from a structure scarcely protruded into the buccal cavity to one with the tip lying free, surrounded by deep buccal pouches and sublingual cavity. A carnivorous diet is related both to a primitive radula (*Gymnomenia*) and to the specialized radulae of *Prochaetoderma* and the Chaetodermatidae (*Chaetoderma* and *Falcidens*).

Evolution to a gastropod-like radula combined with jaws which hold the mouth open in *Prochaetoderma* has made possible a diet which is independent of particle size. A broad food source may be one reason that some species of *Prochaetoderma* are numerically dominant members of the fauna in the deep sea, where food may be limiting.

### INTRODUCTION

The alimentary tract of the Aplacophora, excepting the radula, has generally received less attention than other organ systems. The radula itself has usually been described from histologic preparations; isolated radulae with complete radular membranes have been figured for only a few species in the subclass Chaetodermomorpha (= Caudofoveata) (Kowalevsky, 1901; Scheltema, 1972, 1976; Ivanov, 1979) and for only two species of *Epimenia* in the subclass Neomeniomorpha (= Solenogastres *sensu* Salvini-Plawen) (Baba, 1939, 1940). Gut morphologies have usually been described as part of species descriptions; no integrated overview exists for the class as a whole outside of literature reviews in the standard invertebrate treatises. The literature on feeding and digestion in the

Neomeniomorpha was reviewed by Salvini-Plawen (1967b), who has recently proposed evolutionary sequences in the digestive system in the mollusks (1980). The only developmental studies on the alimentary tract are for *Epimenia verrucosa* (Baba, 1938) and *Neomenia carinata* (Thompson, 1960).

This paper examines the morphologies of the radula and fore- and mid-guts of certain aplacophoran families and relates these morphologies to the feeding type and the ecologic importance of these families in the deep-sea benthos. Possible phylogenetic relationships of the aplacophoran radula and gut morphologies are proposed and the bearing of these relationships to understanding molluscan evolution is discussed. Primary consideration is given to the Chaetodermomorpha, but one primitive neomeniomorph is examined (Fig. 1).

<sup>1</sup>Contribution No. 4655 from the Woods Hole Oceanographic Institution.

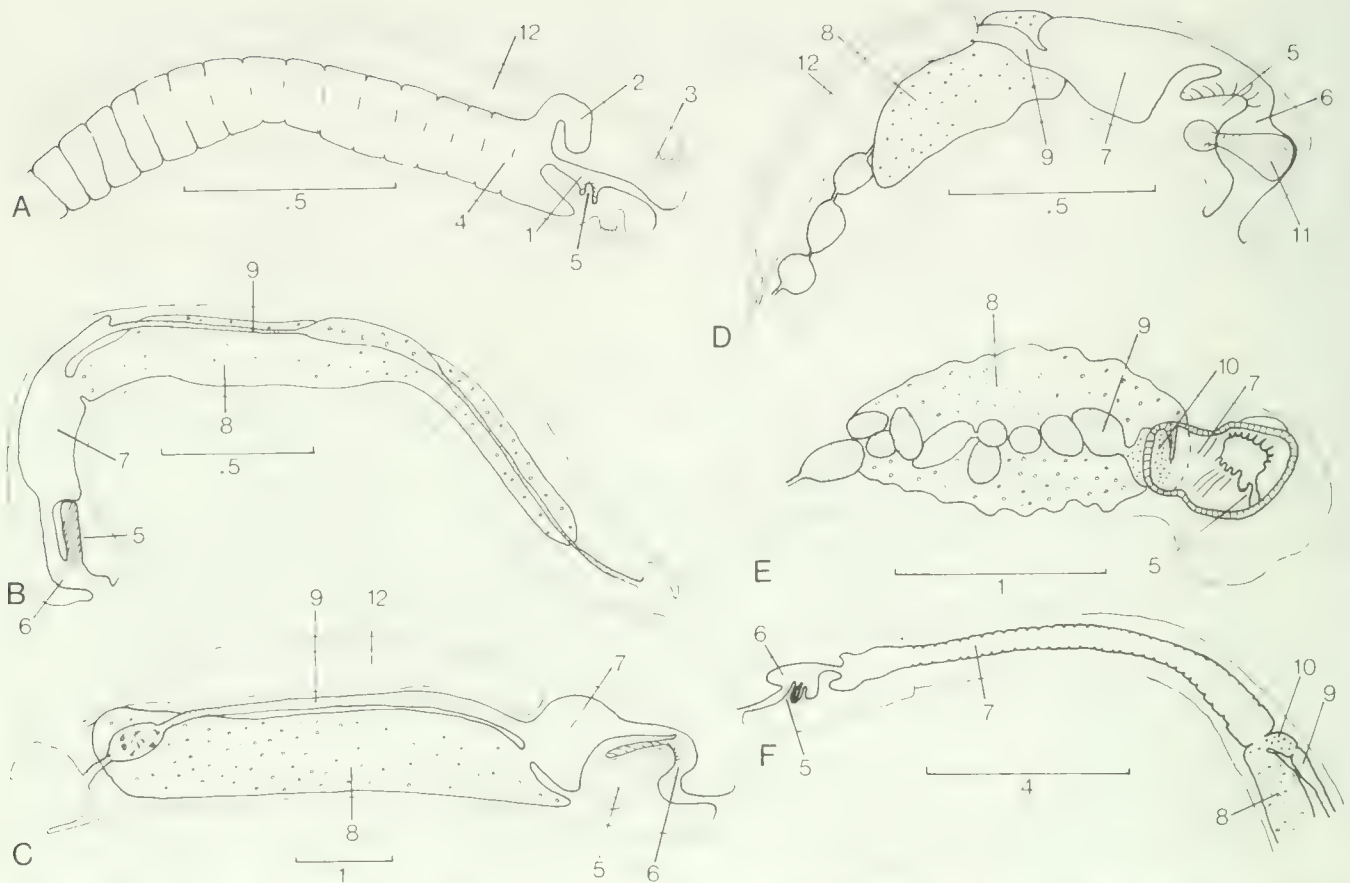

FIG. 1. Alimentary tract of Aplacophora, semi-schematic. A: *Gymnomenia* n. sp., anterior two-thirds only; B: *Scutopus robustus*; C: *Limifossor talpoideus*; D: *Prochaetoderma* sp. y, posterior end not shown; E: *Falcidens caudatus*, posterior end not shown; F: *Chaetoderma nitidulum*, anterior half only. A, F from sagittal sections; B-E from cleared specimens. Gonad not indicated in B, E, or F. Scales in mm. 1, foregut; 2, dorsal caecum; 3, atrium; 4, midgut of undifferentiated stomach and digestive gland; 5, odontophore and radula; 6, buccal cavity; 7, stomach; 8, digestive diverticulum; 9, intestine; 10, style sac; 11, jaws; 12, gonad.

## MATERIALS AND METHODS

Thirteen species in four families and six genera were examined, two species by histologic sections only, three by isolated radula preparations only, and eight by both histologic and radula preparations. All unnamed species or species identified by letter only will be formally described elsewhere.

### Subclass Neomeniomorpha

Fam. Wireniidae (regarded as primitive on basis of spicule shape, thin integument, and lack of ventral foregut glands, Salvini-Plawen, 1978).

(1) *Gymnomenia* n. sp. 620 m, off Walvis Bay, Namibia, Africa (23°00'S, 12°58'E). 4 specimens (cross and sagittal sections, 2 radula preparations).

### Subclass Chaetodermomorpha

Fam. Limifossoridae (regarded as primitive on basis of vestige of ventral foot furrow in *Scutopus*, Salvini-Plawen, 1972a).

(2) *Scutopus megaradulatus* Salvini-Plawen, 1972. 650 m, off Cape Hatteras, North Carolina, U.S.A. (34°14.8'N, 75°46.7'W); 2 specimens (cross sections and radula preparation).

(3) *Scutopus robustus* Salvini-Plawen, 1970. 660 m, Bay of Biscay (48°56'N, 11°02'W); 4 specimens (sagittal sections, 2 gut dissections, and 1 radula preparation).

(4) *Limifossor talpoideus* Heath, 1904. 508-572 m, Alaska; 3 specimens (type material) (cross and sagittal sections, whole mount).

(5) *Limifossor* n. sp. 188-195 m, off east Florida, U.S.A. (27°25'N, 79°53'W); 3 specimens (cross sections, 2 radula preparations).



(6) *Limifossor ?fratula* Heath, 1911. Location unknown. 1 specimen (sagittal sections; Heath material).

#### Fam. Prochaetodermatidae

(7) *Prochaetoderma* sp. y. (a) 805–811 m, S of Woods Hole, Massachusetts, U.S.A. (39°51.3'N, 70°54.3'W); 6 specimens (radula preparations). (b) 1330–1470 m, S of Woods Hole (39°46.5'N, 70°43.3'W); 21 specimens (9 cross and sagittal sections, 12 radula preparations). (c) 1546–1559 m, off Walvis Bay, Namibia, Africa (23°05'S, 12°31'E); 1 specimen (radula preparation).

(8) *Prochaetoderma* sp. c. (a) 1330–1470 m, S of Woods Hole (39°46.5'N, 70°43.3'W); 4 specimens (radula preparations). (b) 2178 m, S of Woods Hole (39°38.5'N, 70°36.5'W); 2 specimens (radula preparations). (c) 2091 m, off Scotland (57°59.7'N, 10°39.8'W); 1 specimen (radula preparation).

(9) *Prochaetoderma* sp. p. 1624–1796 m, off Dakar, West Africa (10°30.0'N, 17°51.5'W); 6 specimens (2 cross and sagittal sections, 4 radula preparations).

#### Fam. Chaetodermatidae

(10) *Falcidens* n. sp. 650 m, off Cape Hatteras (34°14.8'N, 75°46.7'W); 1 specimen (radula preparation).

(11) *Falcidens caudatus* (Heath, 1911). 1102 m, S of Woods Hole (39°48.7'N, 70°40.8'W) and 1330–1470 m, S of Woods Hole (39°46.5'N, 70°43.3'W); 5 specimens (sagittal and cross sections).

(12) *Chaetoderma nitidulum* Lovén, 1844 (= *C. canadense* Nierstrasz, 1902; Scheltema, 1973). 74 m, St. Margaret's Bay, Nova Scotia (44°33'01"N, 65°58'09"W). 4 specimens (sagittal and cross sections) and numerous radula preparations.

(13) *Chaetoderma abidjanense* Scheltema, 1976. 80 m, off Ivory Coast, West Africa (5°02.5'N, 3°47'W); 1 specimen (radula, redrawn from Scheltema, 1976).

Most specimens were fixed as part of an entire washed sample in 10% buffered formalin and changed for preservation to 70 or 80% ethyl alcohol within 24 hr. *Chaetoderma nitidulum* was fixed in Bouin's for histologic sections; all others were refixed in HgCl<sub>2</sub> and acetic acid before sectioning. Stains employed were Delafields' haematoxylin, with eosin, Gray's double contrast, or Ponceau S

as counter-stains. Radulae were isolated by dissecting out the buccal mass and treating with 5% sodium hypochlorite (household bleach) to remove the tissue. The isolated radulae were washed in distilled water and examined in glycerin using a Zeiss interference contrast microscope. Drawings were made with the aid of a camera lucida. One radula of a *Prochaetoderma* species was examined with a scanning electron microscope.

### COMPARATIVE MORPHOLOGY OF ALIMENTARY TRACTS

#### Mouth

The external tissue surrounding the mouth in Aplacophora is usually supplied with mucous cells and nerve strands and the mouth is closed by a sphincter muscle. In some Neomeniomorpha there is a peri-oral fold; in *Gymnomenia* this fold bears numerous cuticular processes, which are extensions of the peri-oral cuticle and presumably receive tactile stimuli (Fig. 2M, N). The cuticle of the peri-oral fold is a continuation of the foregut cuticle, and both are supplied by large mucous glands or masses of mucous cells (ducts were not clearly seen).

The Chaetodermomorpha all have a cuticularized oral shield, divided or undivided and more or less surrounding the mouth opening (Fig. 2D, E, J, L). The cuticle of the oral shield is not part of the epidermal, integumental cuticle (Hoffman, 1949) (Fig. 2A), but is a thickened continuation of the cuticle of the oral tube and buccal cavity in *Scutopus*, *Limifossor*, and *Prochaetoderma* (Fig. 2B, G, K). Nierstrasz (1903) noted the same condition in *Metachaetoderma challengerii*, and Schwabl (1961) considered the oral tube epithelium to be a continuation of the oral shield epithelium in *Falcidens hartmani*. In *Chaetoderma nitidulum* and *Falcidens caudatus* the cuticle of the shield joins that of the oral tube; the latter continues for only a short distance before grading into very dense, long cilia (Fig. 2H, I), which in turn shorten and continue into the buccal cavity (see also Schwabl, 1961).

The epithelial cells underlying the oral shield vary in detail among genera, but certain generalizations seem to hold. There is an abrupt change in epithelial cell type between the cells of the oral shield and those of the oral tube (Fig. 2C, F, arrow); however, the

cuticle itself appears to be homogeneous except for a thickened outermost layer of the oral shield and a zone of fibrils running between the epithelial cells of the oral shield and the cuticle (Fig. 2A, 7; C). The epithelial

cells of the oral shield contain vacuoles and secretory granules (Fig. 2A, F). In *Scutopus* the cuticle is pierced by channels and by scattered pyriform mucous cells which are not grouped into lobes (Fig. 2A). In *Chaetoderma*

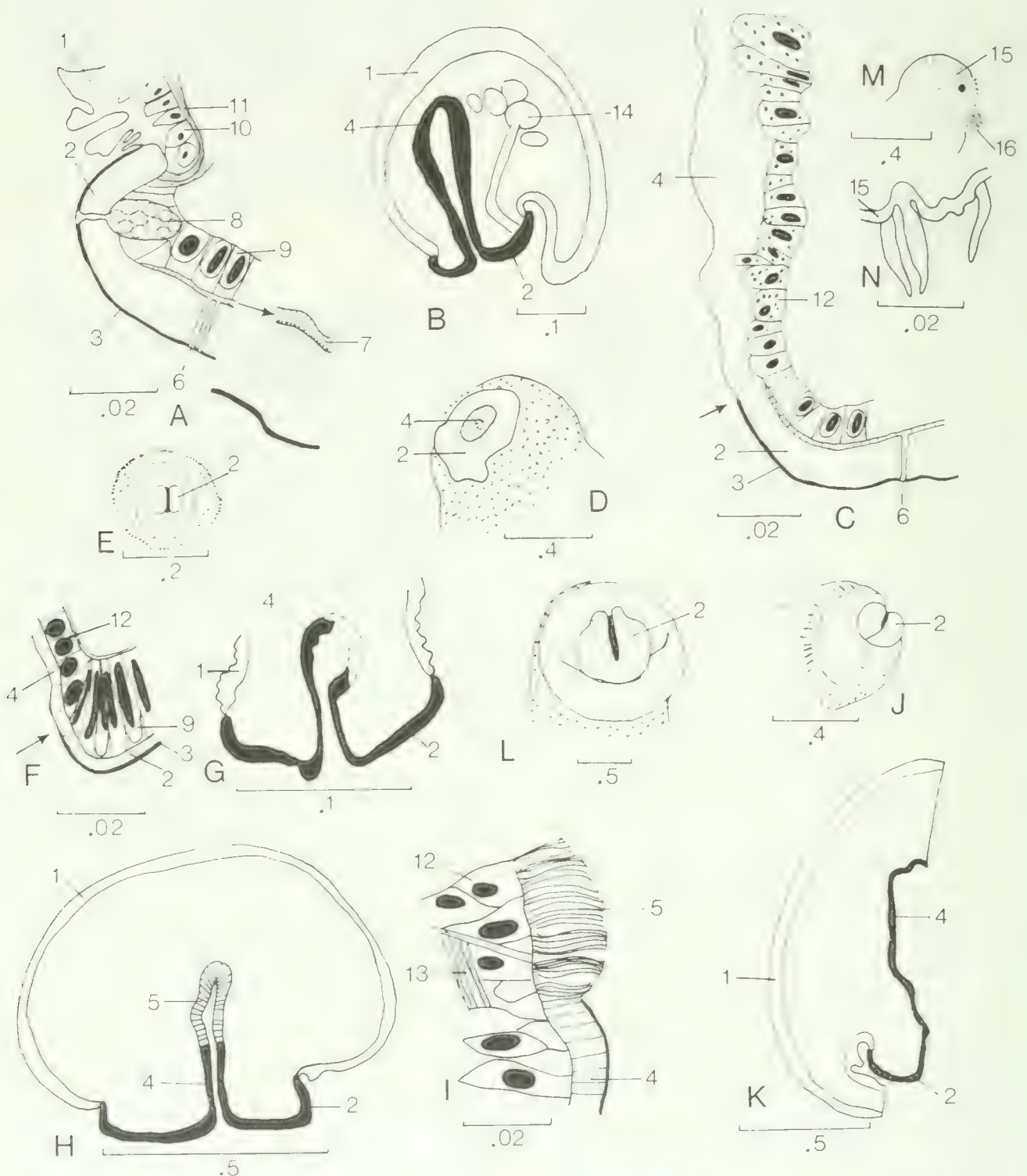

FIG. 2. Mouth of Aplacophora. A-D: *Scutopus megaradulatus*; E-G: *Prochaetoderma* sp. y; H, I, L: *Chaetoderma nitidulum*; J: *Limifossor* n. sp.; K: *Limifossor talpoideus*, one half of section; M, N: *Gymnomenia* n. sp.; B, G, H, K, cross-section through oral shield and oral tube, cuticle of gut black, cuticle of integument stippled; D, E, J, L, M, external views of mouth; A, detail of oral shield and integument; C, F, histologic detail of change from oral shield to oral tube (arrow); I, histologic detail of oral tube; N, tactile extensions of peri-oral cuticle. Scales in mm. 1, epidermal cuticle; 2, oral shield cuticle; 3, outer thickened layer of oral shield cuticle; 4, cuticle of oral tube; 5, cilia of oral tube; 6, channel; 7, zone of fibrils; 8, mucous cell; 9, vacuole; 10, epidermal cell; 11, muscle of body wall; 12, epithelial cell of oral tube; 13, muscles; 14, precerebral ganglion; 15, cuticular peri-oral fold; 16, cilia of pedal pit.

*nitidulum* the mucous cells form lobes which open at the lateral edges of the oral shield (Hoffman, 1949, and confirmed here).

The oral shield seems to serve both in locomotion and as a sensory organ; it is highly innervated by several precerebral ganglia (Hoffman, 1949; Salvini-Plawen, 1972a) (Fig. 2B).

One specimen of *Scutopus megaradulatus* shows that although the thickest part of the oral shield bends away ventrally from the mouth, it is continuous with and surrounds the mouth opening (Fig. 2D), an observation that does not agree with the original description (Salvini-Plawen, 1972b).

### Buccal Cavity

*Gymnomenia* n. sp. As in many Neomeniomorpha, the foregut appears to be suctorial and a buccal cavity as such is not distinct from the rest of the foregut (Fig. 1A). Two sphincters and numerous circular muscles surround the foregut, in addition to the anterior sphincter that closes the mouth. The radula lies between the two posterior sphincters; the posteriormost one defines the juncture of fore- and midgut. Masses of goblet cells surround the foregut, but there is no ventral pair of salivary glands (Fig. 4F). Between the mouth and the first sphincter the secretory cells are basophilic; between the first and second sphincters they stain orange (Orange II counterstain).

*Scutopus* (*S. megaradulatus*). The dorsal half to two-thirds of the buccal cavity is lined by tall goblet cells bearing a thick striated cuticle (Fig. 3A). The goblet cells secrete large yellow granules and empty through the cuticle; they occur in all stages of vacuolization (Fig. 3I). A pair of simple tubular salivary glands 150  $\mu\text{m}$  in length lies ventral to the buccal cavity; they empty near their posterior ends laterally into the buccal cavity at the level of the anterior end of the radula. The tip of the buccal mass does not lie free in the buccal cavity; thus there is no sublingual cavity, and the odontophore remains within the main space of the haemocoel (Figs. 1B, 3A).

*Limifossor* (*L. talpoideus*). The large odontophore tip lies free in the cuticle-lined buccal cavity, and there is a spacious sublingual cavity (Figs. 1C, 3B). Tall goblet cells with large yellow granules similar to those in *Scutopus* line the buccal cavity laterally and dorsally; ventrally the goblet cells are scat-

tered. A pair of tubular salivary glands empties dorsally into the buccal cavity near the radula tip; they originate anteriorly and rather far ventrally (arrow, Fig. 3B).

*Prochaetoderma* (spp. *y*, *p*). The spacious buccal cavity is lined by a thick cuticle (Fig. 3D, E). The epithelium is formed of medium-high columnar to cuboidal cells filled with fine granules; some have a single large yellow secretory body with or without connection to a vacuole (Fig. 3K). The anterior part of the buccal cavity is dominated by a pair of cuticular jaws which hold the mouth open during feeding (Kowalevsky, 1901; unpublished data) (Figs. 1D, 3D). The jaws are abutted by the epithelium of the buccal cavity; laterally they lie directly against basement membrane (Fig. 3H). Thus, they are not part of the buccal cavity cuticle as reported by Schwabl (1961) and are not homologous to gastropod jaws but are unique structures among the molluscs. The bases of the jaws lie wholly within the haemocoel (Fig. 3F; cf. Fig. 7B, C). At the point where their bases join the long anterior ends, the jaws pierce through the buccal cavity wall (Figs. 1D, 3E, G). The cuticle of the jaws is perhaps secreted at the point where the jaws are abutted by the epithelium of the buccal cavity, as indicated by a change in epithelial cell type and by the direction of the striations in the jaws (Fig. 3G, H). Although the major part of the jaws lies within the buccal cavity, they appear to have originated as part of the odontophore mass in the haemocoel (see below under *Radula*).

The tip of the odontophore lies free in the buccal cavity, and the lateral buccal pouches are deep (Fig. 3E). A pair of salivary glands with compound tubules opens dorsally near the beginning of the short esophagus.

*Chaetoderma* (*C. nitidulum*). The epithelium of the spacious buccal cavity is formed by tall, brush-bordered columnar cells containing fine granules; there are also scattered goblet cells with large yellow secretions (Fig. 3C, J). Two pairs of salivary glands with compound tubules open laterally and dorsally into the buccal cavity, one pair at the level of the tip of the radula, the other just anterior to the esophagus (as reported by Wirén, 1892). The odontophore lies free in the buccal cavity for one-half or more of its length.

*Falcidens* (*F. caudatus*). The buccal cavity is similar to that of *Chaetoderma*, but is less capacious. There are perhaps also two pairs of salivary glands; however, ducts were not clearly seen for the dorsalmost pair.

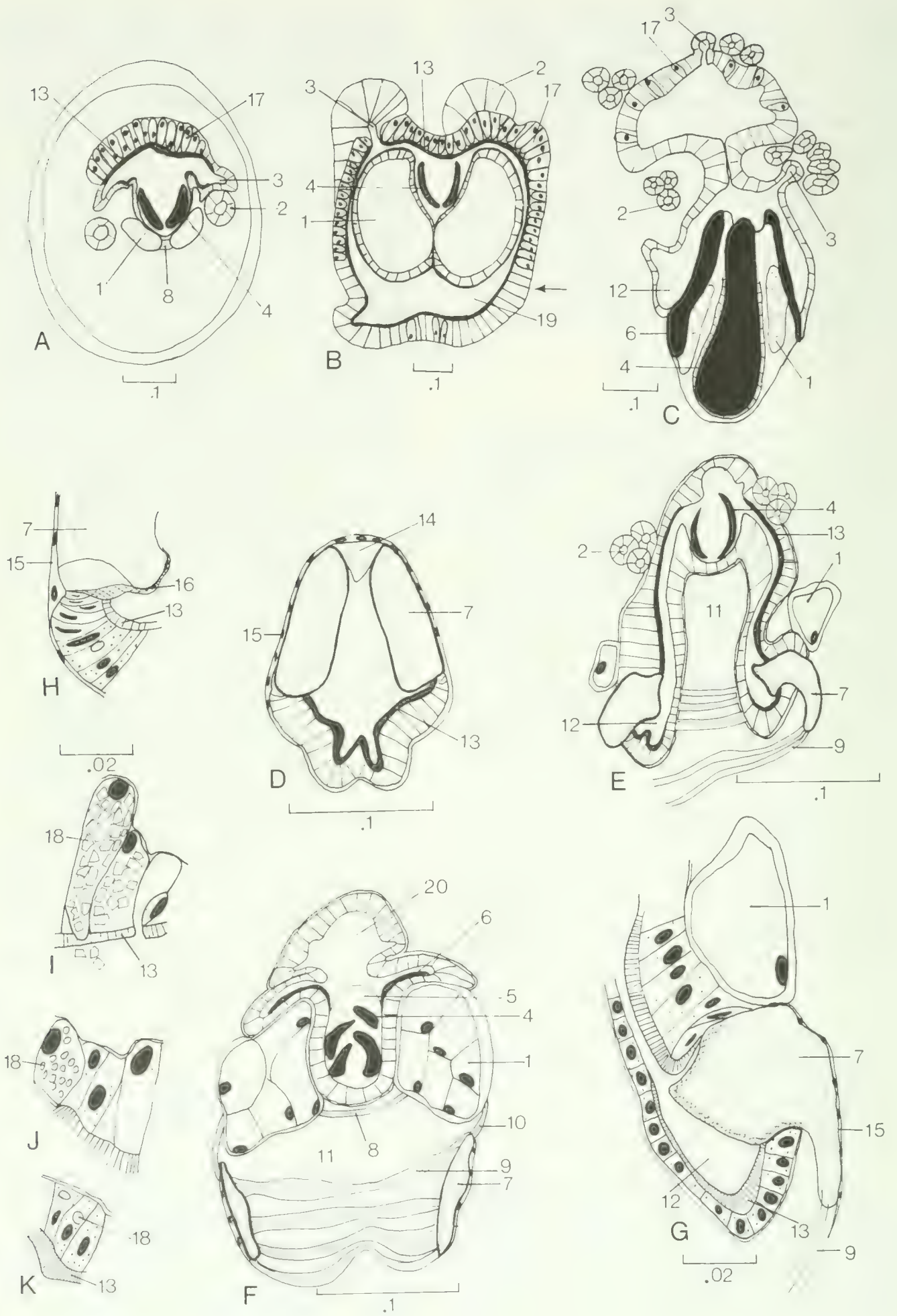

## Radula

The aplacophoran radula has been shown throughout the literature to be very diverse in form, and far more plastic than the gastropod radula. However, there are certain structures common both to aplacophorans and other mollusks.

All isolated radulae that I have studied, except those of the Chaetodermatidae, have a discrete radular membrane with attached distichous rows of teeth issuing from a radular sac, which is a diverticulum of the buccal cavity known to secrete the radular membrane and teeth in gastropods (Fretter & Graham, 1962) and appearing to do so in Aplacophora. There is no evidence for a primitive so-called "basal membrane" that is part of the foregut cuticle and different in some way from a true radular membrane (Boettger, 1956; Salvini-Plawen, 1972a). The radular membrane is supported by an odontophore which lies in the haemocoel. There are one or more pairs of bolsters formed of connective tissue and muscle, or of chondroid tissue, or perhaps of collagen and muscle; in one case there is cuticularization. Protractor and retractor muscles run between the odontophore mass and the body wall, and presumably all aplacophoran radulae can be protracted to, or through, the mouth. In gastropods, muscles that run between a subradular membrane and the bolsters move the radula itself (Graham, 1973); in Aplacophora a subradular membrane is usually, but not always, lacking. The radula musculature has been described for only a few aplacophoran species and will not be described here except for a few particular cases. A bending plane may be either present or lacking; if present, there is no fixed position along the odontophore from genus to genus where it is situated.

*Gymnomenia* n. sp. The tiny radula of *Gymnomenia* was overlooked in the original description of the genus (Odhner, 1921) (Fig. 4); it is considered to be secondarily reduced by Salvini-Plawen (1978). There are about 28

rows of hooked distichous teeth, each with two median denticles in various stages of being tanned. None of the teeth show wear. Each tooth is attached to the radular membrane for one-half its length (Fig. 4B, C). In interference contrast, the radular membrane was seen to be continuous (a) between the teeth of each row as a slight ridge (Fig. 4B, C), which in turn runs down the length of the radula; (b) along and slightly below the base of the teeth lengthwise along the radula (Fig. 4A); and (c) lengthwise along the radula at the level of the denticle in the middle of each tooth (Fig. 4D). Thus, the radular membrane is a continuous sheet which appears to be fused medially; it bears two longitudinal rows of well-affixed teeth. Teeth attached so firmly to the radular membrane can have only limited movements.

The orientation of the radula is similar to that described for *Genitoconia* (Salvini-Plawen, 1967a). The fore-end of the radula is positioned dorsoventrally, where it lies in a blind sheath (Fig. 4E, F). About two-thirds of the distance towards the newest formed teeth in the radular sac there is a bending plane, over which the teeth open into the foregut. The short dorsal radular sac is perhaps bifid as in other Wireniidae, as indicated by the medial ridge of the radular membrane, but further histologic material is needed for substantiation.

The base of the fore-end of the radula lies against the connective tissue (? and commissure), defining the pedal sinus (Fig. 4F); directly beneath this, in the sinus, are about seven calcareous statoliths, each produced by a statocyst (Fig. 4G). In *Genitoconia*, Salvini-Plawen (1967a) described a pedal commissure sac with vesicles which he considered perhaps to be a balancing organ ("ein statisches Organ").

The odontophore protractors and retractors have been described for *Genitoconia* (Salvini-Plawen, 1967a), but the exact manner in which they operate the radula is not clear. The function of the enclosed fore-end of the radula

FIG. 3. Buccal cavity in Chaetodermomorpha. A, I: *Scutopus megaradulatus*; B: *Limifossor talpoideus*, arrow indicates level of blind end of salivary gland; C, J: *Chaetoderma nitidulum*; D-H, K: *Prochaetoderma* sp. y. Scales in mm. 1, bolster; 2, salivary gland; 3, opening of salivary gland into buccal cavity; 4, radular tooth (diagrammatic); 5, radular membrane; 6, subradular membrane; 7, jaw; 8, ventral approximator of bolsters; 9, ventral approximator of jaw; 10, tensor between bolster and base of jaw; 11, lumen of odontophore; 12, buccal pouch; 13, cuticle of buccal cavity; 14, dorsal cuticular membrane between distal end of jaws; 15, basement membrane; 16, deeply staining portion of jaw cuticle; 17, goblet cell; 18, large yellow granule; 19, sublingual cavity; 20, esophagus.

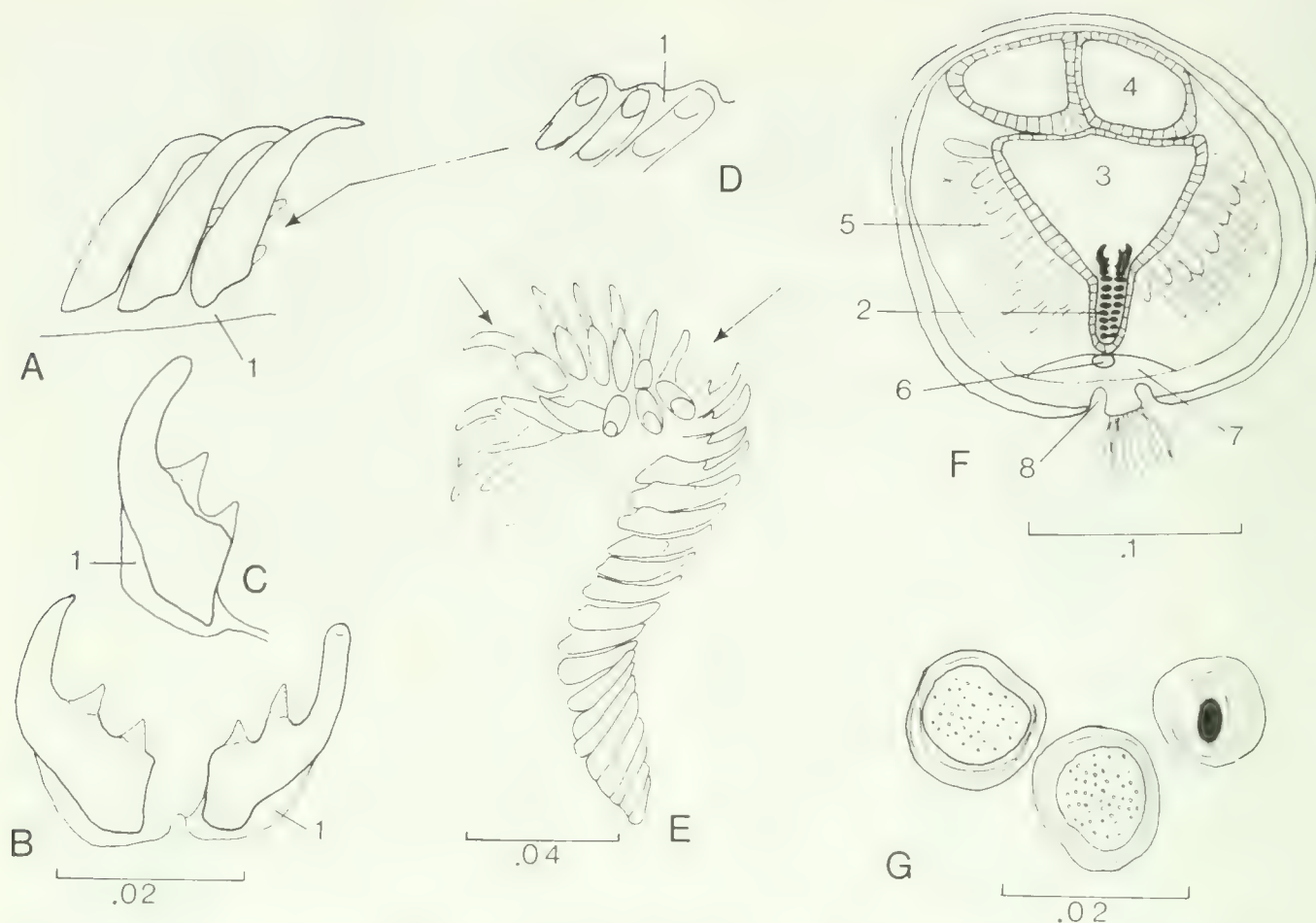

FIG. 4. Radula and statoliths of *Gymnomenia* n. sp. A-D: radular teeth; A, lateral view; B, C, anterior view; D, median view at level of middle denticle indicated by arrow on A; E: radula, lateral view, dorsal at top, anterior to right, most recently formed teeth to left, teeth between arrows exposed in pharynx; F: cross-section showing exposed teeth in foregut and sheath around fore-end of radula resting against statocyst. G: two statoliths and a statocyst cell filled with amorphous substance. Scales in mm, A-D at same scale. 1, radular membrane; 2, radula; 3, foregut; 4, paired dorsal caecum of midgut; 5 goblet cells; 6, statocyst; 7, pedal sinus; 8, pedal pit.

is not known; it may act as a supporting rod-like structure. The proximity of the radula to the statocysts of the pedal sinus may or may not indicate a direct relationship between them. The exposed teeth perhaps are able weakly to tear at soft tissue as it is sucked into the foregut, and very probably serve to move food backwards toward the midgut.

*Scutopus* (*S. robustus*, *S. megaradulatus*). The radula is formed of seven or more pairs of teeth in a straight, nearly anteroposterior position, with the distal ends of the teeth lying anteriorly to the proximal ends (Figs. 5A, B, 11D). Thus, the older of any two rows of teeth lies beneath and anterior to the younger, and the odontoblasts lie on the dorsal side of the radular sac. There is no bending plane. The teeth of *S. megaradulatus* and *S. robustus* are thick and massive, with pointed tips and many large median denticles which curve ventrally and posteriorly (Fig. 5D). From histo-

logic sections and whole preparations the radular membrane was seen to be formed of two longitudinal bands connected only between each pair of teeth (Fig. 5C). Each band extends laterally along the side of each tooth, but these extensions are not connected (Fig. 5C, D). Thus, the teeth are free to slide past each other, perhaps moved by the ventral tensor (Fig. 5A); they can also be closed by a large dorsal approximator muscle running between the anterior pair of bolsters (Fig. 5A, B). These rather limited possibilities for movement combined with the absence of a bending plane and of a sublingual cavity suggest a simple shovelling or pulling in of food. The radula probably cannot be protruded very far beyond the end of the radular sac, and the teeth do not show any wear.

*Limifossor* (*Limifossor* n. sp., *L. talpoides*). The radula with its massive odontophore was well described by Heath (1905),

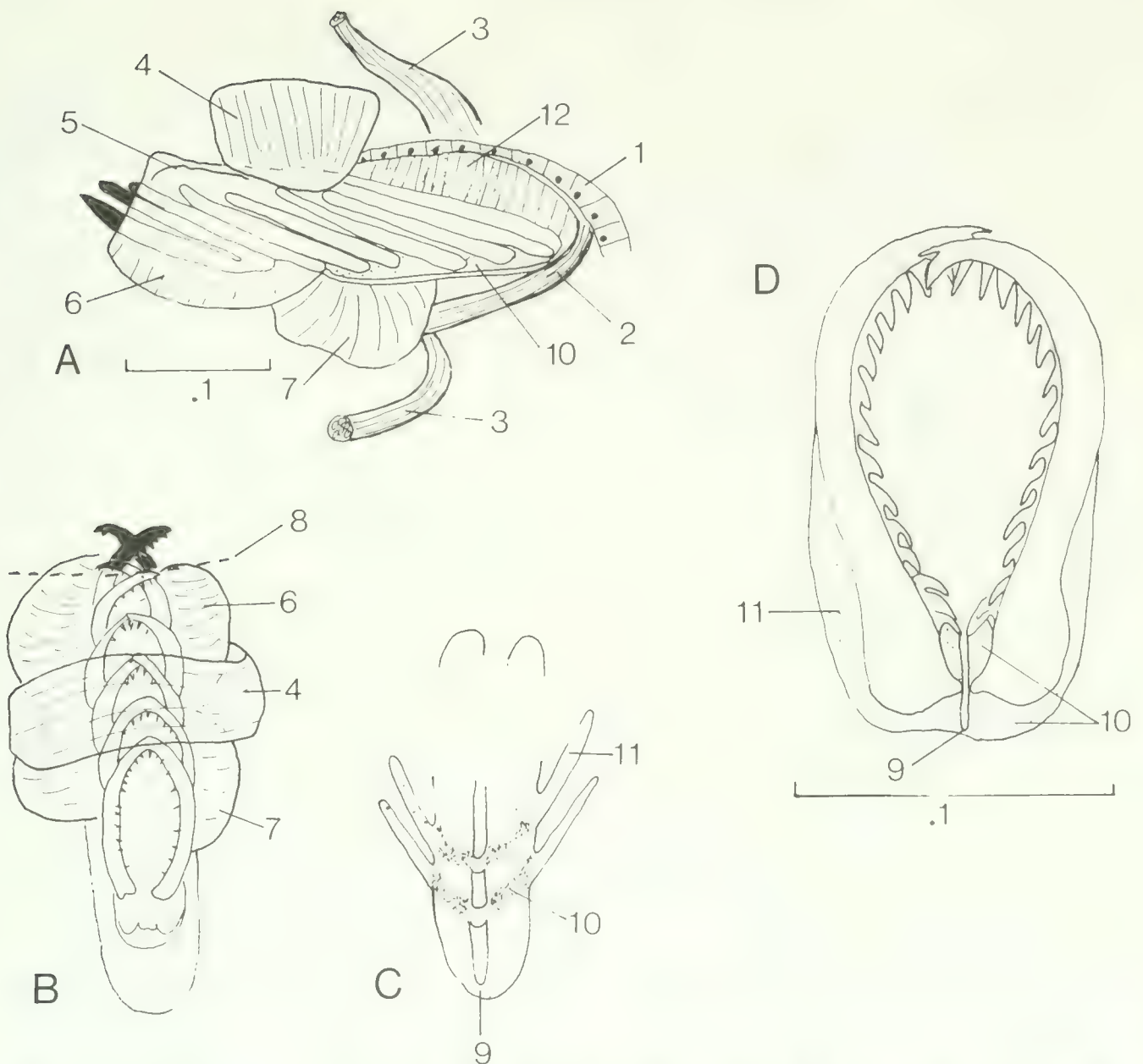

FIG. 5. Radula of *Scutopus*. A, B, D: *S. robustus*; C: *S. megaradulatus*. A, lateral view of buccal mass, anterior to left, teeth beyond radular sheath black; B, dorsal view, anterior end at top; C, diagrammatic representation of radular membrane; D, pair of radular teeth. Scales in mm, A and B at same scale. 1, midgut epithelium; 2, ventral tensor muscle; 3, protractors; 4, dorsal approximator of bolsters; 5, radular sac; 6, anterior bolster; 7, posterior bolster; 8, anterior limit of radular sac; 9, radular membrane connecting pair of teeth; 10, radular membrane attached to base of teeth; 11, lateral extension of radular membrane; 12, odontoblasts of radula.

who illustrated the musculature and watched the radular movements of living animals. A few observations may be added to his.

As Heath noted, the radular membrane is a continuous sheet only at the posterior end of the radula; farther anteriorly it splits along the midline (arrow, Fig. 6B) and continues as two bands. The radular membrane extends for a short distance up the lateral side of each tooth, and these lateral extensions are in connection along the radula (Fig. 6A, C). The teeth are massive, with long lateral hooks and shorter median hooks turned posteriorly (Fig.

6C, D); the bases have a thickened ridge posteriorly. The teeth are set close to each other along the radula; each tooth thus appears to act as a fulcrum for the next posterior one (Fig. 6C, D). There is a large mass of muscle fibers, the tooth adductor, that Heath (1905) found to be responsible for moving the opposed teeth toward each other (Fig. 6B); there is a dorsal approximator of the bolsters, present as in *Scutopus*, which is also probably important in bringing the two rows of teeth together (Fig. 6B). None of the teeth show wear.

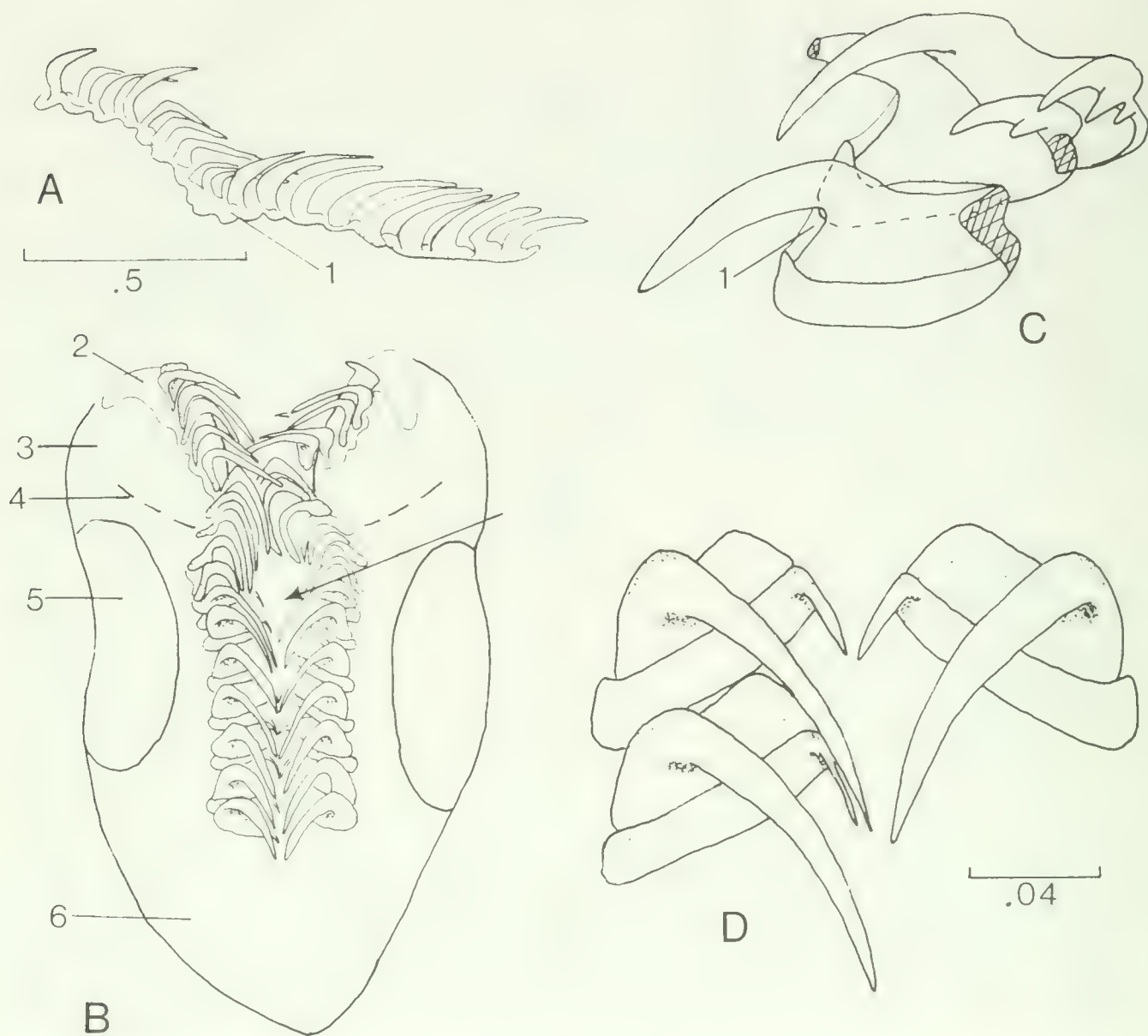

FIG. 6. Radula of *Limifossor* n. sp. A: lateral view of radula, dorsal at top, anterior to left; B: dorsal view of radula and odontophore, anterior at top; arrow indicates point where radular membrane splits into two bands; C, D: oblique and dorsal views of teeth in natural position. Scales in mm, A-B and C-D at same scales. 1, radular membrane; 2, subradular membrane?; 3, odontophore mass; 4, anterior limit of radular sac; 5, attachment of dorsal approximator of bolsters; 6, area of large tooth adductor muscle.

A certain amount of rotation of the teeth is possible, as shown in Figure 6B. These movements are made possible by (a) the median split in the radular membrane, which frees the two longitudinal rows anteriorly, (b) the use of each tooth as a fulcrum by the next posterior one, (c) the presence of a rudimentary bending plane, (d) the possible existence of a subradular membrane for tensor insertion, and (e) a deep sublingual cavity, which frees the entire buccal mass from the haemocoel (Fig. 3B). Heath reported that the odontophore swept past the teeth when the mouth was open. Certainly the radular teeth are able to go through a more complicated set

of movements than can those of *Scutopus* or *Gymnomenia*. Less certain is whether the radula is used for tearing or simply is an improved form of rake.

*Prochaetoderma* (spp. y, p, c). Kowalevsky (1901) figured the isolated distichous radula of *Prochaetoderma raduliferum*; some details can be added.

Most noticeable are the two large cuticular jaws that nearly fill the space in the head (Fig. 7A-C). Anteriorly they are connected by a membrane (Figs. 3D, 7C); posteriorly within the haemocoel a large bundle of muscle fibers runs between their bases, and a small fiber runs between each base and the chon-



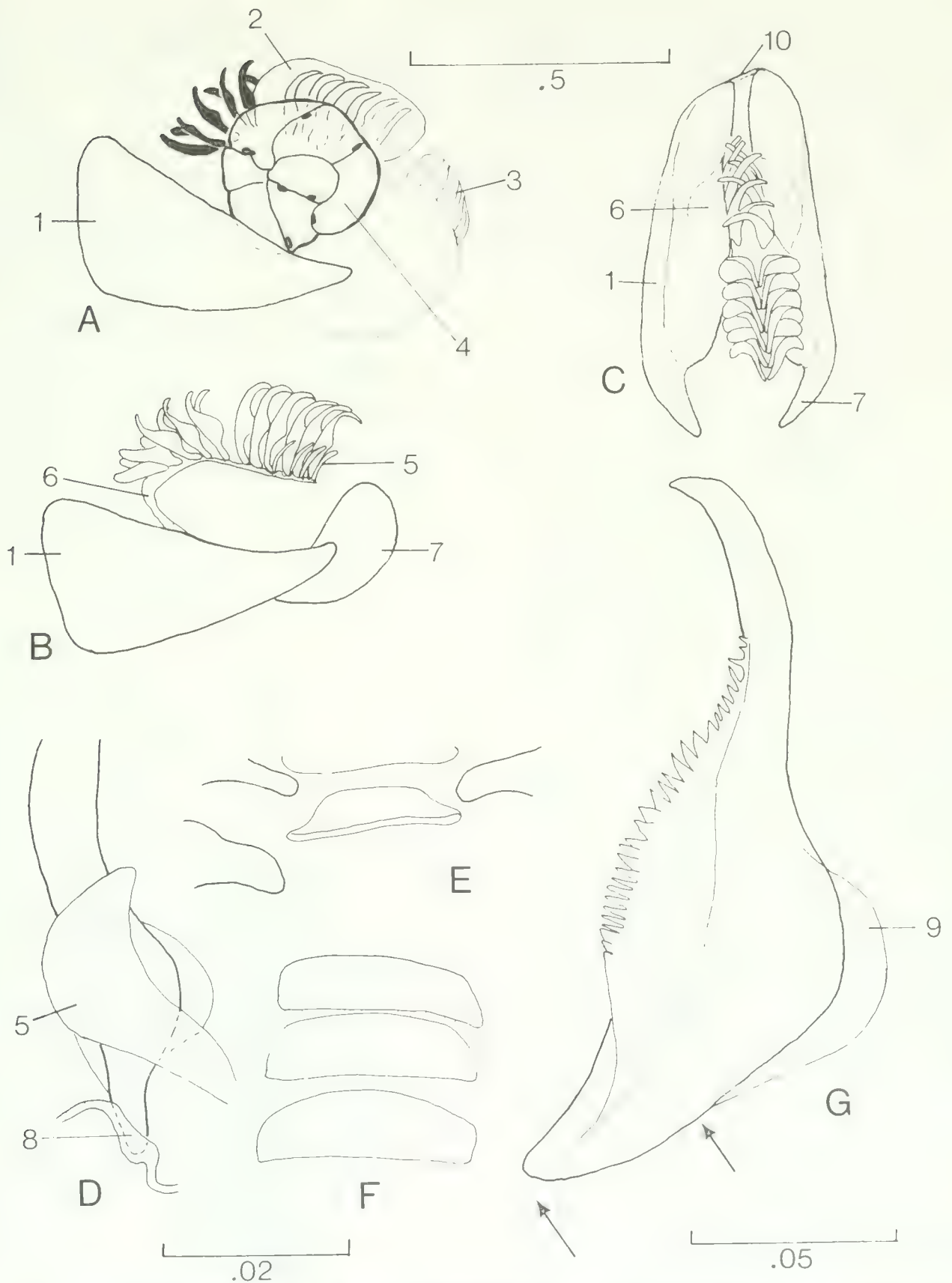

FIG. 7. Radula of *Prochaetoderma*. A-F: *Prochaetoderma* sp. y; G: *Prochaetoderma* sp. p. A, lateral view of jaws, radula, and odontophore, anterior to left; B, same as A, tissue removed; C, dorsal view of B, anterior at top; D, base of tooth, with lateral tooth-like extension and radular membrane in darker stippling; E: oblique view of central plate, or tooth, in relation to proximal ends of teeth; F: row of central plates, anterior at top; G: single radular tooth with membranous denticulate medial brush and lateral membranous wing, attachment to radular membrane between arrows. Scales in mm, A-C and D-F at same scales. 1, cuticular jaw; 2, radular sac; 3, tensor muscles between jaws; 4, chondroid bolster; 5, toothlike lateral extension of radular membrane; 6, subradular membrane; 7, case of jaw which lies within haemocoel; 8, radular membrane; 9, membranous wing of radular tooth; 10, dorsal cuticular membrane.

droid bolster immediately dorsal to it (Fig. 3F). The jaws serve to hold the mouth open, and the radula is protruded between them. The musculature which protracts and retracts the jaws has not been described.

The radular membrane is a continuous sheet to which only the tips of the proximal ends of the teeth are attached (Fig. 7D, G; observation substantiated by scanning electron microscopy). Laterally the membrane is drawn out into a tooth-like extension beside each tooth; the extension is not attached to the tooth but appears to support it in some manner (Figs. 7B, D, 11A). A bending plane lies at the anterior end of the odontophore (Fig. 7B). Uniquely in the Aplousobranchia, a central plate, or tooth, lies between the bases of each pair of teeth (Fig. 7E, F). The four to six pairs of anterior teeth are crossed and used in feeding (Figs. 7C, 11C); the anterior-most pair are worn (Fig. 11B). The posterior teeth, which probably remain within the radular sac, seem to function as a backstop for food particles carried between the membranous median brush-like extensions of the teeth (Figs. 7G; 11C). There is a subradular membrane, distinct from the radular membrane (Figs. 3F, 7B).

The radula of *Prochaetoderma* appears to reduce the size of food material by rasping before ingestion on the following evidence: (a) the mouth can be held open by the jaws probably independent of radular protrusion; (b) the teeth can articulate, for they are free of the radular membrane laterally and there are median supportive teeth; (c) the chondroid tissue of the bolsters provides a stiff structure to work beneath the protruded radula; (d) there is a bending plane at the anterior end of the odontophore over which the teeth can be articulated; (e) the anterior teeth are worn. Kowalevsky (1901) described the protracted, anterior crossed teeth in living animals as projecting through a wide-open mouth and constantly in motion as if to seize something.

*Falcidens* and *Chaetoderma* (several species). The very specialized radulae of the Chaetodermatidae (Fig. 8) have already been described in detail from isolated preparations (Scheltema, 1972). Paired denticles or lateral projections attached to the end of a cone-shaped rod presumably act as grasping pincers; tensors run between them and the bolsters (Schwabl, 1961; Ivanov, 1979) (Fig. 8C). There are three published interpretations of the cone-shaped structure: it represents a fused radula (Scheltema, 1972); it is a greatly

thickened basal membrane (Salvini-Plawen, 1972a); it is one of three teeth of a monosegmental radula (Ivanov, 1979). The cone lies within an epithelial sheath, perhaps the radular sac (Fig. 8C), and is secreted at its thick, ventral end. The identity of growth lines in the cone of *Chaetoderma* with those in *Prochaetoderma* jaws is highly improbable (Salvini-Plawen & Nopp, 1974), for the jaws appear to be a part of the odontophore mass

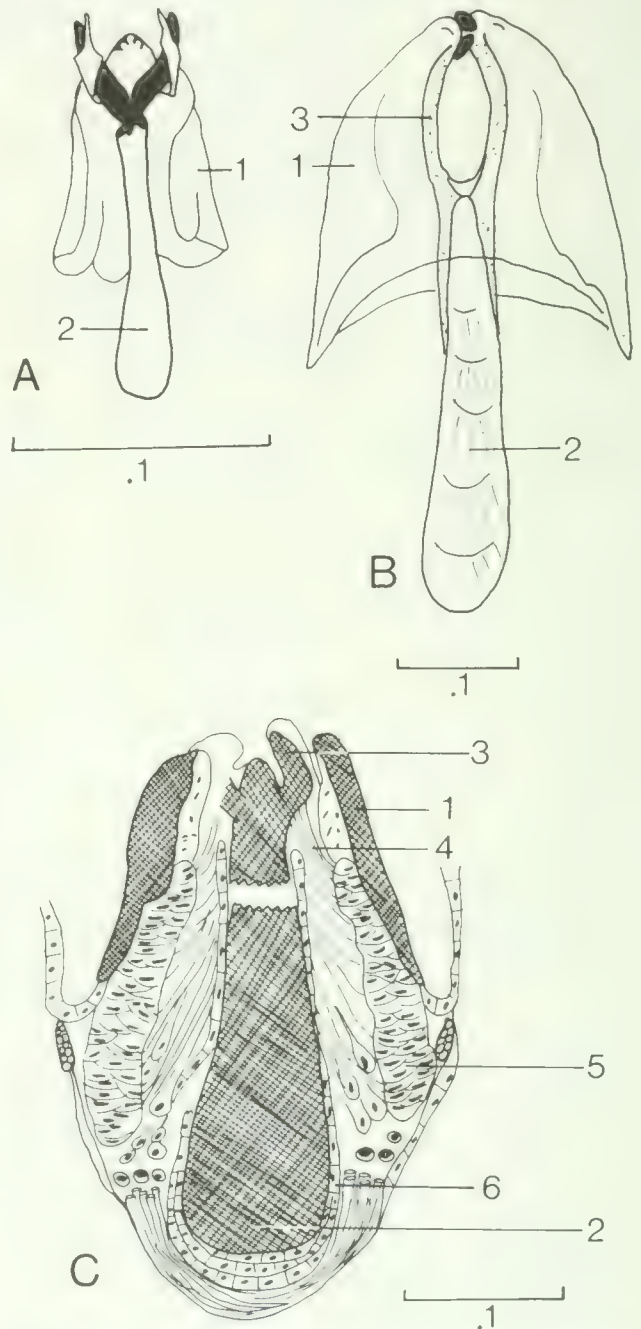

FIG. 8. Radulae of *Chaetoderma* and *Falcidens*. A: *Falcidens* n. sp.; B: *C. abidjanense* (from Scheltema, 1976); C: *C. nitidulum*, histologic section. Scales in mm. 1, cuticle surrounding buccal mass (subradular membrane?) 2, cone-shaped tooth; 3, lateral projection; 4, tensors of lateral projection; 5, bolster; 6, epithelium surrounding cone-shaped tooth (radular sac?).

within the haemocoel and are not underlain by epithelium (cf. Figs. 3D, E, F, 8C).

### Esophagus

The esophagus is defined as that part of the foregut forming a tube above the radula and connecting the buccal cavity and stomach. Its epithelium is differentiated from the epithelium of both the buccal cavity and the stomach.

*Gymnomenia* n. sp. An esophagus is lacking in *Gymnomenia* but not in all Neomeniomorpha, although Odhner (1921) considered the posterior pharynx of *G. pellucida* to be an esophagus.

*Scutopus* (*S. megaradulatus*). The buccal cavity opens dorsally into a short, wide esophagus formed of low cuboidal epithelium with a brush border; the cells are filled with fine, yellow granules. A short distance posteriorly the lateral walls acquire folds, and the ventral wall thickens. The folds merge dorsally and become ciliated; posteriorly they coalesce into a typhlosole that continues into the stomach.

*Limifossor* (*L. talpoideus*, *L. ?fratula*). As described by Heath (1905), the esophagus is a long, ciliated, narrow tube with several longitudinal folds; the cells are filled with granules. Dorsally the ciliated epithelium is continued into the stomach.

*Prochaetoderma* (sp. *y*, *p*). The esophagus is extremely short and bears no cilia; however, Schwabl (1963) reported a ciliated esophagus in *P. californicum*.

*Falcidens* (*F. caudatus*). The esophagus is discernible from the buccal cavity only by its long, slender goblet cells which lie between the buccal cavity and stomach.

*Chaetoderma* (*C. nitidulum*). Cells with a brush border line a muscular esophagus. At the entrance to the stomach there are very long, slender goblet cells but no cilia; these coalesce dorsally and become the ciliated typhlosole in the stomach.

### Midgut

Neomeniomorpha. The stomach is a single wide tube interrupted laterally at regular intervals by the dorsoventral musculature (Fig. 1A). In most Neomeniomorpha there is an antero-dorsal paired or unpaired caecum (Fig. 4F). The cell types of the midgut are not described here. A dorsal ciliated tract or fold runs the length of the midgut and leads into a short, posteriorly placed, ciliated intestine

(Pruvot, 1891; Salvini-Plawen, 1978); it was not seen in *Gymnomenia*, however.

Chaetodermomorpha. All members of the Chaetodermomorpha investigated here have a stomach, a sac-like ventral digestive diverticulum that opens into the posterior end of the stomach, and a long ciliated intestine that follows a bend in the posterior stomach. Nierstrasz (1903) reported that *Metachaetoderma challengerii* lacked a separate midgut gland in the one incomplete specimen he examined, but this observation needs to be repeated. Except in *Prochaetoderma* there is either a dorsal ciliated typhlosole or a groove that runs down the stomach to the ciliated intestine. The epithelial cells lining the stomach are homogeneous and contain granules; cell shape varies among genera and species. The cells of the digestive gland are unique among mollusks: the dorsal wall is lined by a band of cells packed with coarse yellow granules (lacking in *Prochaetoderma*) (Fig. 10H); laterally and ventrally are cells which secrete large basophilic spheres (Fig. 10G). A mucoid or proteinaceous rod is present in all genera except *Prochaetoderma*, but its position in the gut varies.

*Scutopus* (*S. megaradulatus*, *S. robustus*). The stomach is long and divided by septa which do not run its entire length. These do not appear to be the same as the outpouchings that Salvini-Plawen (1972a, fig. 16) illustrated for *S. ventrolineatus* related to dorsoventral musculature. The granular cells of the stomach epithelium have a striated or brush border; anteriorly they are low and cuboidal, but farther posteriorly they become high and club-shaped (Fig. 10A, B). A strip of the stomach epithelium passes into the digestive diverticulum and continues there as a dorsal band of granular cells with greatly coarsened granules (Figs. 9A–C, 10B, H, 11D). A dorsal ciliated typhlosole (Fig. 10A, C) runs from the esophagus to the intestine; there is a second ciliated typhlosole arising at the base of the stomach that also runs to the intestine. A patch of ciliated cuboidal cells with densely staining borders opposes the bend that joins stomach and intestine (Fig. 9A, I).

In three specimens out of a sample of 19 *S. robustus*, the stomach epithelium was nearly colorless owing to the lack of cell granules. Dissection of two of these colorless specimens revealed that the stomach contained several solid, proteinaceous (stained by rose Bengal), acellular, parallel rods which were presumably formed by secretions from the



septate stomach (Fig. 11E). Crystals of about  $40\ \mu\text{m}$  adhered to the outsides of the rods; these crystals became more densely packed posteriorly. Both rods and crystals passed into the anterior intestine; farther posteriorly the crystals, but not the rods, formed part of a fecal mass. The crystals may be organic, as they dissolved in dilute HCl (but not  $\text{NH}_4\text{OH}$ ) and broke down into an amorphous yellow mass when subjected to pressure by squeezing them beneath a glass coverslip. In *S. megaradulatus* sections, the stomach was empty and the stomach cells were packed with granules; there was only a short mucoid rod at the anterior end of the intestine.

Fecal material in *Scutopus* is formed into a long spindle-shaped mass along a straight intestine (Fig. 1B).

*Limifossor* (*L. talpoideus*, *L. ?fratula*). The epithelium of the very short (*L. talpoideus*, Fig. 1C) or very long (*L. ?fratula*) stomach are formed of tall (former) or short (latter) cuboidal granular cells with a striated or brush border. A dorsal typhlosole runs from the esophagus to the intestine. At the posterior bend between the stomach and intestine in *L. talpoideus* the cells are thickly ciliated (?brush border) and have a thick amorphous border resembling cuticle (Fig. 9D, J). Within the anterior ciliated intestine (interpreted originally as a style sac, Scheltema, 1978) is a mucoid rod (Fig. 9D, E). The digestive diverticulum is long. Fecal material is formed into oblong masses along a straight intestine.

*Prochaetoderma* (spp. *y*, *p*). The stomach is lined by low cuboidal cells probably with a cuticular border; cilia are lacking. The short digestive diverticulum lacks a dorsal band of granular cells and is formed only of secretory cells which are modified from the type found in other chaetoderms; the cell granules are eosinophilic and there are few basophilic, spherical secretions. There is no mucoid rod. The short anterior section of the intestine may

be bent or straight. Fecal material is formed into discrete spherical masses strung out along a long, convoluted intestine (Fig. 1D).

*Chaetoderma* (*C. nitidulum*). The stomach and digestive diverticulum are long (Fig. 1F). A dorsal typhlosole starts just posterior to the esophagus and runs the length of the stomach and into a style sac (Fig. 9N); only the medial cells of the typhlosole are ciliated anteriorly (Fig. 10E). The stomach epithelium is formed of low cuboidal cells with a striated or brush border; the granular cells of the dorsal band in the digestive diverticulum are very tall with a striated border and were not seen to be in connection with the stomach epithelium. At the base of the stomach there is a thick, hooklike cuticular gastric shield underlain by tall columnar cells which are granule-filled distally and striated basally; fibrils run between the cuticle and cell walls (Fig. 9L, N). The ciliated style sac runs between the stomach and the intestine transversely to the long axis of the body; it contains a mucoid rod in some specimens (Fig. 9M) (see also Scheltema, 1978, fig. 1B). The rod appears to rotate against the gastric shield, inasmuch as food material between the rod and the shield occurs in spiral swirls. The style sac is formed of granular cells with dense, short cilia; a broad ridge borders a groove with longer cilia which continues into the intestine (Fig. 9F–H, M). Fecal material is formed into oblong masses; the intestine is straight.

*Falcidens* (*F. caudatus*). The stomach is short and bilobed (Fig. 1E); its epithelium is formed of low cuboidal cells with yellow granules and a cuticular border (Fig. 10D). A strip of these cells continues, without a cuticular border, into the digestive diverticulum where it becomes the dorsal band of granular cells of that organ. The digestive diverticulum extends broadly to where the body narrows into a "tail."

A dorsal ciliated groove, rather than typhlo-



FIG. 9. Posterior stomach, anterior intestine, and opening of digestive diverticulum in Chaetodermomorpha. A–C, I: *Scutopus megaradulatus*; D, E, J: *Limifossor talpoideus*; F–H, L–N: *Chaetoderma nitidulum*; K: *Falcidens caudatus*. A–C, cross-section from anterior to posterior, viewed anteriorly; D, E, nearly adjacent sagittal sections, anterior to right; F–H, M, oblique sections through style sac of two specimens, one showing groove (enlarged in G) running into intestine (H) and one with protostyle (M); I–L, morphocline of cells from ciliated to cuticularized at bend between stomach and intestine (I enlarged from A, 8; J from D, 8; K from N, 7). N, oblique view anterior to M at junction of stomach and style sac, showing gastric shield. Scales in mm, A–C, D–E, I–L, M–N, at same scales. 1, dorsal band of granular cells; 2, secretion cells with basophilic spheres; 3, intestine; 4, stomach; 5, bend between stomach and intestine; 6, style sac; 7, gastric shield; 8, specialized cells at bend between stomach and intestine; 9, style sac ridge; 10, style sac groove; 11, dorsal typhlosole; 12, mucoid rod (protostyle); 13, bolus entering intestine; 14, gonad.

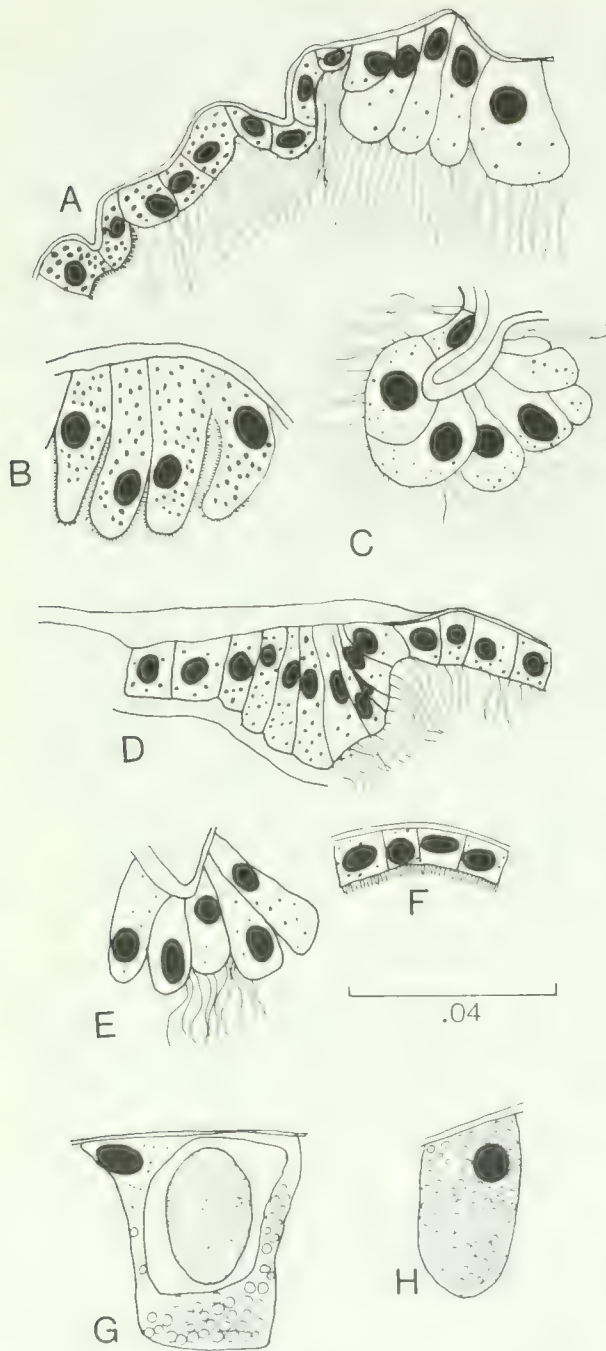

FIG. 10. Cells of alimentary tract in Chaetodermomorpha. A-C, H: *Scutopus megaradulatus*; D: *Falcidens caudatus*; E-G: *Chaetoderma nitidulum*. A-F, granular stomach cells and dorsal ciliated typhlosole or groove (B, C posterior to A); G, digestive gland secretory cell with basophilic sphere; H, cell from dorsal band of granular cells of digestive gland.

sole (Fig. 10D), starts about half way down the length of the stomach and leads to a hook-like gastric shield (Scheltema, 1978, fig. 1C), and thence continues into a style sac. A second, ventral ciliated band starts at about the level of the gastric shield and joins the dorsal typhlosole to form a style sac with a mucoid rod and ciliated ridge bordering a groove. The rod appears to rotate against the gastric shield. Schwabl (1961) described and figured

schematically the gastric shield and style sac for *F. hartmani* without considering them as such, although referring to the style sac as "caecum-like"; a mucoid rod is not mentioned. The cells underlying the gastric shield are cuboidal with large granules distally (Fig. 9K). The style sac is transverse to the body axis (Fig. 1E).

The intestine is convoluted and filled with spherical fecal masses.

#### Diet

The diet of the species under discussion is based on stomach contents. Not available to me at this time of writing is Salvini-Plawen's work (in press) on diet (see Literature Cited).

*Gymnomenia* n. sp. As in most Neomeniomorpha, there are many unexploded nematocysts within the cells of the midgut; *Gymnomenia* is therefore considered to feed on Cnidaria.

*Scutopus*. The diet is not known; fecal material contains organic (?) crystals and perhaps sediment particles. The radula morphology suggests that the diet is particle-size dependent, probably detritus.

*Limifossor*. The diet is not known. Fecal material contains very small bits of unidentified frustules, spicules and other hard parts of organic origin. Although *Limifossor* has usually been considered a carnivore (Heath, 1905; Salvini-Plawen, 1975), it seems quite as likely from radula morphology that it is a detritivore and possibly particle-size dependent.

*Prochaetoderma*. The diet seems to be a wide variety of both prey and organic debris. The stomach of several specimens hold Foraminifera with sand tests (?*Saccorhiza*), crustacean parts, radular teeth of smaller *Prochaetoderma*, and bits of unidentified organic remains; much of the food material still contains stained cytoplasm. There are very few sand grains.

*Chaetoderma* and *Falcidens*. The Chaetodermatidae are considered to be selective carnivores, taking in entire Foraminifera, "worms," small snails and other unidentified organisms which are found in the stomach with stained cytoplasm. Ivanov (1979) has figured the action of feeding. *C. nitidulum* can be a contaminant in laboratory cultures of living Foraminifera upon which they will feed (B. Christensen, personal communication). It is not known whether members of the Chaetodermatidae also feed on organic debris. There are few sand grains in the gut.

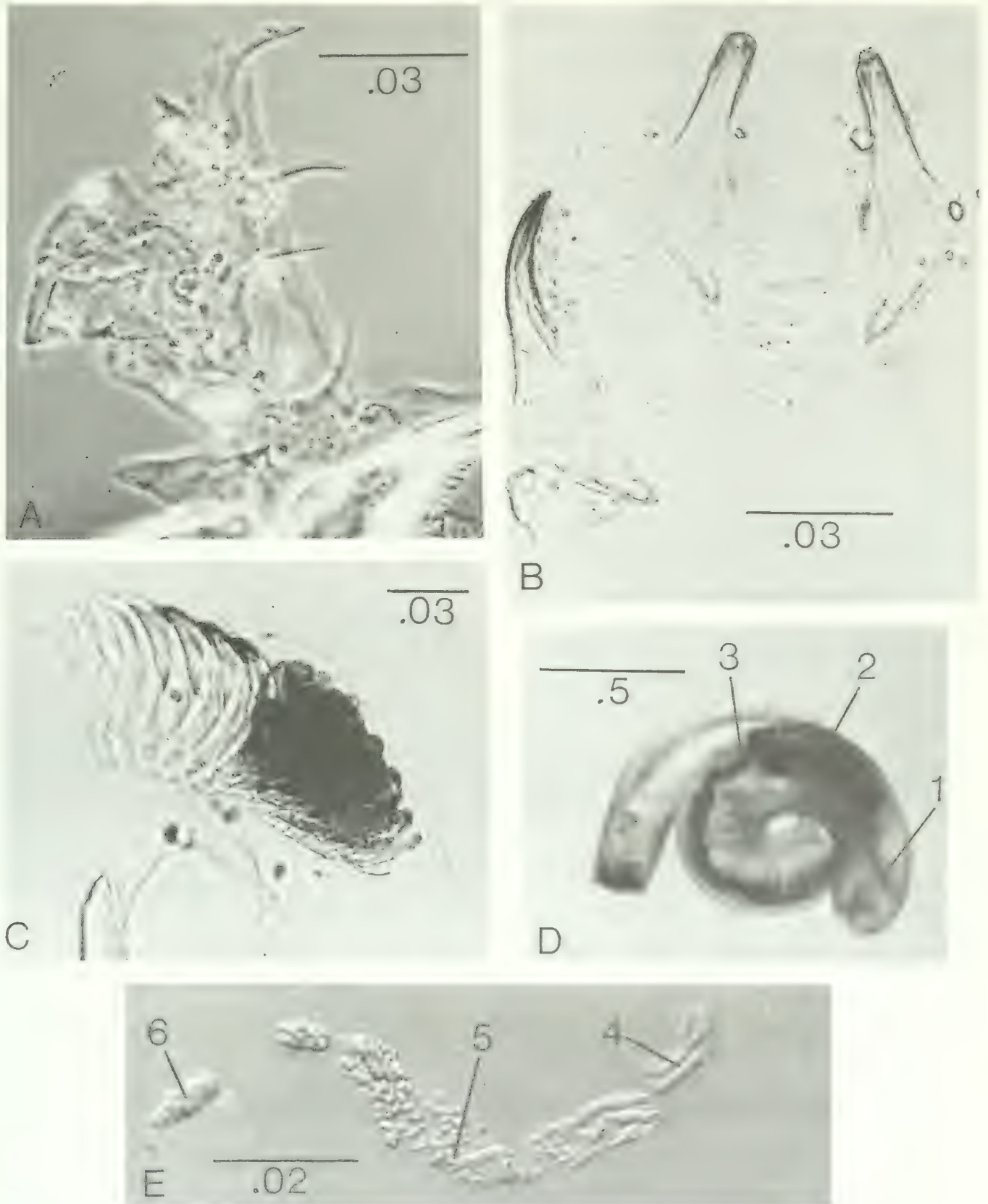

FIG. 11. Radula of *Prochaetoderma* sp.  $\gamma$  (A-C) and alimentary tract of *Scutopus robustus* (D, E). A: lateral tooth-like extensions of radular membrane; B: worn anterior pair of denticles; C: food material caught in crossed pairs of anterior teeth, held against posterior 6-7 pairs touching at distal tips; note darkened, tanned distal tips; D: entire preserved specimen in transmitted light; E: proteinaceous rods with adhered crystals dissected from stomach and intestine of a specimen without dark granules evident in D. Scales in mm. 1, radula; 2, darkly pigmented stomach; 3, band of granular cells passing from stomach to dorsal wall of digestive gland; 4, rods from anterior stomach; 5, rods and crystals at base of stomach and entrance into intestine; 6, fecal material.

## DISCUSSION

## Phylogenetic Considerations: Intraclass

The Neomeniomorpha and Chaetodermomorpha are considered by me to be subclasses belonging to the class Aplacophora (Scheltema, 1978) and their great specialization of acquiring a worm shape to have evolved as a single event before evolution of the molluscan shell (i.e., a shared derived character state). The chaetoderm oral shield was thought by Hoffman (1949) to be homologous to the outer wall of the ventral foot furrow of the neomeniomorphs (homology is not with the foot sole, Scheltema, 1978). This homology is not substantiated by the observation that the chaetoderm oral shield is formed from cuticularized gut epithelium that has come to lie externally like lips (Fig. 2). Moreover, the mucous cells of the oral shield in the primitive species *Scutopus megaradulatus* are diffuse and do not occur in lobes as required by this homology (Hoffman, 1949). Therefore the separation of the Chaetodermomorpha (Caudofoveata) from all other mollusks as the most primitive molluscan

class on the basis of this homology is not upheld (see Salvini-Plawen, 1972a, paragraph 16).

In considering which character states of the alimentary tract may be primitive and which may be derived among the Aplacophora (Table 1), the following assumptions are made: (a) the Aplacophora are the sole living representatives of the primitive pre-placophorous mollusks and geologically very old (see Stasek, 1972; Salvini-Plawen, 1972a; Scheltema, 1978); (b) the least differentiated character state is usually the most primitive, unless there is some evidence for loss of structure; (c) a character state shared by most or all members is usually primitive, unless some evidence points to the contrary; (d) the radula capable of the least amount of manipulation is most primitive.

From the table certain relationships are clear (numbers below refer to character number in the table). The primitive character states held in common between the two subclasses are: cuticularization of the foregut (1); paired tubular salivary glands (lying ventrally both in *Scutopus megaradulatus* and in most Neomeniomorpha; perhaps secondarily lack-

TABLE 1. Primitive and derived character states of the aplacophoran alimentary tract (C = *Chaetoderma*, F = *Falcidens*, G = *Gymnomenia*, L = *Limifossor*, P = *Prochaetoderma*, S = *Scutopus*).

Character	Primitive	Derived (a, b, independently derived)
<u>Oral shield</u>		
(Neomeniomorpha not considered)	Entire S, F, C	Divided L, P
<u>Buccal cavity</u>		
1. Cuticle	Present G, S, L, P	Absent F, C
2. Goblet cells	Dominant G, S, L	Scattered P, F, C
3. Tubular salivary glands	One pair (most Neomeniomorpha) S, L, P	(a) Two pairs (F?), C (b) <sup>1</sup> Lacking G
4. Buccal sublingual pouch	Absent, or nearly so G, S	Present L, P, F, C
<u>Radula</u>		
5. Radular membrane	Divided or partially so, or line of fusion G, S, L	Entire P, (F?, C?)
6. Subradular membrane	Absent G, S	Present (L?), P, (F?, C?)



TABLE 1 (Continued).

Character	Primitive	Derived (a, b, independently derived)
7. Dentition	Distichous, without central plate G, S, L	(a) Distichous, with central plate P (b) Reduced F, C
8. Relationship of teeth to radular membrane	Not articulated G, S, L	(a) Articulated P (b) Reduced F, C
9. Bolster tissue	Connective tissue, muscle (G?), S, L, F, C	Chondroid-like P
10. Cuticular structure derived from odontophore	Absent G, S, L, F, C	Present P
11. Dorsal approximator of bolsters	Present (primitive?) S, L	Absent (derived?) G, P, F, C
<u>Esophagus</u>		
12. Length	Long, short S, L, C	(a) Extremely short P, F (b) Absent (derived?) G
13. Ciliation	Ciliated S, L	Not ciliated P, F, C
<u>Midgut</u>		
14. Ciliated dorsal band, groove, or typhlosole	Present (nearly all Neomeniomorpha) S, L, F, C	Absent (G?), P
15. Digestive diverticulum	Absent (primitive?) G (and all other Neomeniomorpha)	Present (derived?) S, L, P, F, C (and all other Chaetodermomorpha)
Chaetodermomorpha only:		
16. Dorsal granule cells, digestive diverticulum	Present S, L, F, C	Absent P
17. Lining of stomach	Not cuticular S, L, C	Cuticular (P?), F
18. Gastric shield	Absent S, L, P	Present F, C
19. Style sac	Absent S, L, P	Present F, C
20. Mucoïd or protein rod(s)	Present throughout stomach and anterior intestine S	(a) Present, restricted location L, F, C (b) Absent P
<u>Feeding, diet</u>		
21. Feeding type	Detritivore-omnivore S, L, P	Selective carnivore G, F, C
22. Particle size	Dependent S, (L?) F, C	Independent (a) Suctorial G (b) Rasping P

<sup>1</sup>Considered primitive by Salvini-Plawen (1978).

ing in *Gymnomenia*) (3); a distichous radula lacking articulation (7, 8); a divided or fused radular membrane and lack of a subradular membrane (5, 6); and a ciliated dorsal band, groove, or typhlosole that runs the length of the midgut to a ciliated intestine (14). The foregut goblet cells (2) may not be homologous (cf. Figs. 3A, B, 4F).

The greatest difference between the two subclasses lies in the presence or absence of a digestive diverticulum (15). The undivided midgut of the Neomeniomorpha has been interpreted as primitive on the basis of (a) the lack of digestive adaptations (digestive gland, protostyle, gastric shield) for microphagous feeding (Salvini-Plawen, 1980) and (b) the presence of regular outpouchings caused by serially arranged dorso-ventral musculature (Boettger, 1956; Salvini-Plawen, 1969). (These outpouchings were first considered to be primitively lacking in *Genitoconia*, a member of the Wireniidae which includes *Gymnomenia* [Salvini-Plawen, 1967a], but later the lack of lateral pouches was considered to be secondarily derived [Salvini-Plawen, 1978]). Most neomeniomorphs have a very specialized cnidarian diet and thus the undivided midgut may be a specialized or reduced state, and not a primitive one. The single digestive diverticulum of the chaetoderms appears to have developed as a lobe from the stomach; it retains the evidence of its origin in the dorsal band of granular cells which can be traced forward to the stomach epithelium.

Among the Chaetodermomorpha there are two lines of evolutionary change from the least differentiated and therefore presumed primitive state found in *Scutopus*. One direction has been toward increased elaboration of the stomach into a posterior style sac, restriction of the protostyle to this sac, and increased cuticularization at the base of the stomach to form a gastric shield; morphoclines of these character states exist from *Scutopus* through *Limifossor* to *Falcidens* and *Chaetoderma* (Fig. 9). The other direction has been toward reduction as found in *Prochaetoderma*, with a single type of digestive cell in a shortened digestive diverticulum, no dorsal ciliated typhlosole, and no protostyle. The gastric shield is not correlated with general cuticularization of the stomach epithelium (Table 1: 17, 18). A convoluted intestine is found independently in the two genera that have long, thin "tails," *Prochaetoderma* and *Falcidens* (Fig. 1D, E).

The aplacophoran radula has evolved to-

wards freeing the teeth from their primitively broad attachment to the radular membrane and toward development of a sublingual pouch (4, 8). The result has been increased ability to manipulate or break down the food source.

In *Gymnomenia* the radula appears to be one of the most primitive among the Aplacophora (Fig. 4), but much work remains to be done on the diverse radular types found in other Neomeniomorpha (Nierstrasz, 1905; Salvini-Plawen, 1967b, 1978). Among cnidarian feeders with a suctorial foregut, reduction and specialization could be expected; nevertheless, a primitive type of radula occurs in carnivores in the Aplacophora.

The radulae among chaetoderm genera differ greatly in morphology and cannot readily be derived from a primitive type or from each other except in terms of function. Primitively, teeth are affixed to the radular membrane and the odontophore is scarcely free in the buccal cavity; only a sliding motion combined with closing opposed teeth is possible (*Scutopus*, Fig. 5). More complicated movements can occur in *Limifossor* with a split radular membrane and a relatively enormous odontophore (Figs. 1C, 6B; Heath, 1905). A rasping gastropod-like radula has evolved only in *Prochaetoderma* (Fig. 7). The reduced, highly modified radula of *Falcidens* and *Chaetoderma* is probably capable of precise movement in prey capture (Ivanov, 1979). The two most highly evolved radulae occur in the two groups which are carnivorous or carnivorous-omnivorous and which also have the most modified midguts: *Prochaetoderma* with the most complex radula and most reduced midgut and the Chaetodermatidae (*Falcidens* and *Chaetoderma*) with the most modified radula and most complex midgut. There does not appear to be a morphocline in radula type in the Chaetodermomorpha (see Salvini-Plawen, 1975).

#### Phylogenetic Considerations: Interclass

The style sac and gastric shield are shown by the Aplacophora to have evolved more than once in the Mollusca. In the Aplacophora, a protostyle has evolved before a style sac, and a style sac and gastric shield occur only in a carnivorous family (Chaetodermatidae).

A radula capable of rasping seems to require a single radular membrane, a subradular membrane, a bending plane, firm bolsters,

and some way for the teeth to articulate on the radular membrane. There also must be some way to keep the mouth open during rasping. In gastropods the mouth opens as part of radula protraction (Graham, 1973), but in *Prochaetoderma*, which uses its head for locomotion (burrowing) as well as for feeding, unique jaws have evolved which can keep the mouth open during rasping. The significance of rasping as a feeding mechanism is that feeding is not particle-size dependent (Table 1: 22); large pieces of food can be broken down and manipulated before ingestion, whether the food be a large algal mat on a hard surface, prey, or large pieces of detritus. The ability to manipulate food before ingestion may be one of the reasons for the great success of the gastropods.

It is not possible on the evidence presented here to determine the structure of the archimolluscan alimentary tract. Certainly it had a nonarticulated radula with protractors, retractors, and bolsters, paired tubular salivary glands, a cuticular foregut, and a dorsal ciliated tract running down the midgut. If the Neomeniomorpha have retained a primitive midgut even though they have become food specialists, then a digestive gland must have been derived more than once in the mollusks. On the other hand, if the neomeniomorph midgut is reduced, then a protostyle without a style sac or gastric shield and a digestive diverticulum could have been primitively present in the mollusks, a condition that would lead more directly to parallel evolution in the molluscan midgut of a style sac and gastric shield. The two studies on aplacophoran gut development for two Neomeniomorpha did not have this question in mind (Baba, 1938; Thompson, 1960), but Baba observed that the intestine arises from endoderm and that the midgut epithelium when it first forms is thickest laterally and ventrally, as it is in the chaetoderm digestive diverticulum.

The evidence from entire, isolated radulae of Aplacophora indicates for the mollusks an original state of distichous rows of teeth on a divided radular membrane. The evidence for an original single basal membrane with rows of broad monoserial teeth rests on reconstructions from histologic sections of the neomeniomorph radula of *Dondersia* (Nierstrasz, 1905), on histologic sections of *Simrothiella* (Salvini-Plawen, 1972a), and on ontogenetic studies on chitons (Minichev & Sirenko, 1974). Kerth (1979) has shown, on the other hand, that distichous teeth on a sin-

gle membrane develop ontogenetically in the pulmonates.

The questions of whether the archimolluscan radula was a single or paired structure and whether or not the midgut had a digestive diverticulum is left open for further observations on isolated aplacophoran radulae, comparative histologic studies and studies on development.

#### Ecological Considerations

Although Aplacophora are ubiquitous in the deep sea from the edge of the continental shelf to the deepest abysses and hadal depths, they seldom are numerically an important constituent of the macrofauna. The two chaetoderm genera described here which are the most primitive also have the fewest known species: *Scutopus* (4) and *Limifossor* (4). The number may be doubled, at most, from existing collections not yet described. The carnivorous species belonging to *Falcidens* and *Chaetoderma* are far more numerous, although their total numbers in any one sample are never great (unpublished data).

Species of *Prochaetoderma* are numerous (unpublished data) and can be the numerically dominant macrofaunal animals in quantitative samples. *Prochaetoderma* sp. *y* was the dominant species in a total of twenty-five 35-cm<sup>2</sup> tubular cores taken at one 1,760-m station off Woods Hole (Grassle, 1977), although dominance was not high (6.0%; discrepancy from Grassle's data due to recent recognition of a sibling species). The next four most numerous species were polychaete worms (5.1%, 4.4%, 4.2%, and 3.7%) (nematodes, ostracods, and copepods excluded). Actual density of *Prochaetoderma y* was 309 m<sup>-2</sup>. In a ¼-m<sup>2</sup> spade box core taken in the same area, this species was the fourth most numerous species with a density of 192 m<sup>-2</sup>. In other quantitative samples in the same area, *Prochaetoderma y* ranged in numbers up to 237 m<sup>-2</sup>, and in grab samples taken between 1141 and 2148 m depths it ranged up to 400 m<sup>-2</sup>.

In a ¼-m<sup>2</sup> spade box core taken in the remarkably productive Aleutian Trench off Alaska at a depth of 7298 m, another *Prochaetoderma* was one of the dominant species at a density of 124 m<sup>-2</sup> (Jumars & Hessler, 1976).

The numerical success of some species of *Prochaetoderma* may be attributable in part

to their efficient gastropod-like rasping radula, which has made a wide size range of food sources available to them in an environment where food is probably a limiting factor.

### CONCLUSION

The Aplacophora exhibit a wide variation in morphology of the alimentary tract. Comparative studies of these morphologies give insight into evolutionary events and function among the Mollusca and lead to a greater understanding of feeding in the deep sea.

### ACKNOWLEDGMENTS

Material was made available to me by Howard L. Sanders (Woods Hole Oceanographic Institution), Centre Océanologique de Bretagne, Paul S. Mikkelson (Harbor Branch Foundation, Fort Pierce, Florida), and P. Leloeuff and A. Intes (Centre de Recherches Océanographiques, Abidjan, Côte d'Ivoire). Arthur G. Humes, June F. Harrigan, and Isabelle P. Williams kindly read the manuscript critically. To all of these are due my gratitude. To Rudolf S. Scheltema go especial thanks for many a provocative discussion about clarity in presenting morphology. The materials from Woods Hole Oceanographic Institution were collected and sorted under National Science Foundation grants GB 6027X, GA 31105, and GA 36554.

### LITERATURE CITED

- BABA, K., 1938, The later development of a solenogastre, *Epimenia verrucosa* (Nierstrasz). *Journal of the Department of Agriculture, Kyushu University*, 6: 21–40.
- BABA, K., 1939, Preliminary note on *Epimenia verrucosa* (Nierst.). *Venus*, 9: 35–42 (in Japanese).
- BABA, K., 1940, *Epimenia ohshimai*, a new solenogastre species from Amakusa, Japan. *Venus*, 10: 91–96 (in Japanese).
- BOETTGER, C. R., 1956, Beiträge zur Systematik der Urmollusken (Amphineura). *Zoologischer Anzeiger*, Suppl. 19: 223–256.
- FRETTER, V. & GRAHAM, A., 1962, *British prosobranch molluscs*. Ray Society, London, 755 p.
- GRAHAM, A., 1973, The anatomical basis of function in the buccal mass of prosobranch and amphineuran molluscs. *Journal of the Zoological Society of London*, 169: 317–348.
- GRASSLE, J. F., 1977, Slow recolonisation of deep sea sediment. *Nature*, 265: 618–619.
- HEATH, H., 1905, The morphology of a solenogastre. *Zoologische Jahrbücher, Abteilung für Anatomie und Ontogenie der Tiere*, 21: 703–734, pl. 42–43.
- HOFFMAN, S., 1949, Studien über das Integument der Solenogastren nebst Bemerkungen über die Verwandtschaft zwischen den Solenogastren und Placophoren. *Zoologiska Bidrag från Uppsala*, 27: 293–427.
- IVANOV, D. L., 1979, Structure and functional morphology of the radular system in *Chaetoderma* (Mollusca, Caudofoveata). *Zoologicheskii Zhurnal*, 58: 1302–1306 (in Russian).
- JUMARS, P. A. & HESSLER, R. R., 1976, Hadal community structure: implications from the Aleutian Trench. *Journal of Marine Research*, 34: 547–560.
- KERTH, K., 1979, Phylogenetische Aspekte der Radulamorphogenese von Gastropoden. *Malacologia*, 19: 103–108.
- KOWALEVSKY, A., 1901, Sur le genre *Chaetoderma*. *Archives de Zoologie expérimentale et général*, sér. 3, 9: 261–284, pl. 10–12.
- MINICHEV, A. S. & SIRENKO, B. J., 1974, Development and evolution of the radula in Polyplacophora. *Zoologicheskii Zhurnal*, 53: 1133–1139 (in Russian).
- NIERSTRASZ, H. F., 1903, Neue Solenogastren. *Zoologische Jahrbücher, Abteilung für Anatomie und Ontogenie der Tiere*, 18: 359–386, pl. 35–36.
- NIERSTRASZ, H. F., 1905, *Kruppomenia minima* und die Radula der Solenogastren. *Zoologische Jahrbücher, Abteilung für Anatomie und Ontogenie der Tiere*, 21: 665–702, pl. 39–41.
- ODHNER, N. H., 1921, Norwegian Solenogastres. *Bergens Museums Aarbok 1918–1919*, Nr. 3, 1–86, pl. 1–6.
- PRUVOT, G., 1891, Sur l'organisation de quelques néoméniens des côtes de France. *Archives de Zoologie expérimentale et général*, sér. 2, 9: 699–806, pl. 25–31.
- SALVINI-PLAWEN, L. v., 1967a, Neue scandinavische Aplacophora (Mollusca, Aculifera). *Sarsia*, 27: 1–63.
- SALVINI-PLAWEN, L. v., 1967b, Über die Beziehungen zwischen den Merkmalen von Standort, Nahrung und Verdauungstrakt bei Solenogastres (Aculifera, Aplacophora). *Zeitschrift für Morphologie und Ökologie der Tiere*, 59: 318–340.
- SALVINI-PLAWEN, L. v., 1969, Solenogastres und Caudofoveata (Mollusca, Aculifera): Organisation und phylogenetische Bedeutung. *Malacologia*, 9: 191–216.
- SALVINI-PLAWEN, L. v., 1972a, Zur Morphologie und Phylogenie der Mollusken: Die Beziehungen der Caudofoveata und der Solenogastres als Aculifera, als Mollusca und als Spiralia. *Zeitschrift für wissenschaftliche Zoologie*, 184: 305–394.

- SALVINI-PLAWEN, L. V., 1972b, Die Caudofoveata des Mittelmeeres und das Genus *Scutopus* (Mollusca, Aculifera). In *Fifth European Marine Biology Symposium*, Battaglia, B. (ed.) Piccin, Padua, p. 27–51.
- SALVINI-PLAWEN, L. V., 1975, Mollusca Caudofoveata. *Marine Invertebrates of Scandinavia* 4, Universitetsforlaget, Oslo, 55 p.
- SALVINI-PLAWEN, L. V., 1978, Antarktische und subantarktische Solenogastres (eine Monographie: 1898–1974). *Zoologica* (Stuttgart), 44: 1–315.
- SALVINI-PLAWEN, L. V., 1980, Molluscan digestive system in evolution. *Haliotis*, 10(2): 127 [abstract].
- SALVINI-PLAWEN, L. V., in press? Diets for aplacophoran and monoplacophoran molluscs. *Handbook of Nutrition and Food*, CPC Press.
- SALVINI-PLAWEN, L. V. & NOPP, H., 1974, Chitin bei Caudofoveata (Mollusca) und die Ableitung ihres Radulaapparates. *Zeitschrift für Morphologie der Tiere*, 77: 77–86.
- SHELTEMA, A. H., 1972, The radula of the Chaetodermatidae (Mollusca, Aplacophora). *Zeitschrift für Morphologie der Tiere*, 72: 361–370.
- SHELTEMA, A. H., 1973, Heart, pericardium, coelomoduct openings, and juvenile gonad in *Chaetoderma nitidulum* and *Falcidens caudatus* (Mollusca, Aplacophora). *Zeitschrift für Morphologie der Tiere*, 76: 97–107.
- SHELTEMA, A. H., 1976, Two new species of *Chaetoderma* from off West Africa (Aplacophora, Chaetodermatidae). *Journal of Molluscan Studies*, 42: 223–234.
- SHELTEMA, A. H., 1978, Position of the class Aplacophora in the phylum Mollusca. *Malacologia*, 17: 99–109.
- SCHWABL, M., 1961, *Crystallophrisson* (= *Chaetoderma*) *hartmani* nov. spec., eine neue Aplacophore aus dem Östpazifik. *Zoologischer Anzeiger*, 166: 258–277.
- SCHWABL, M., 1963, Solenogaster mollusks from southern California. *Pacific Science*, 17: 261–281.
- STASEK, C. R., 1972, The molluscan framework. In *Chemical Zoology*, VII. *Mollusca*, FLORKIN, M. & SCHEER, B. T. (eds.), p. 1–44.
- THOMPSON, T. E., 1960, The development of *Neomenia carinata* Tullberg (Mollusca Aplacophora). *Proceedings of the Royal Society of London*, ser. B, 153: 263–278.
- WIRÉN, A., 1892, Studien über die Solenogastres. I. Monographie des *Chaetoderma nitidulum* Lovén. *Konglige Svenska Vetenskaps-Academiens Handlingar*, 24(12): 66 p., 7 pl.



## MORPHOLOGICAL AND BEHAVIOURAL ASPECTS OF FEEDING IN THE CASSIDAE (TONNACEA, MESOGASTROPODA)

Roger N. Hughes and Helen P. I. Hughes

*Department of Zoology, University College of North Wales,  
Gwynedd, LL57 2UW, United Kingdom*

### ABSTRACT

Anatomy of the feeding apparatus, properties of the proboscis gland secretion, diet, and feeding behaviour of the Cassidae are reviewed from published data. New data are presented on the alimentary morphology of *Cassis tuberosa* and on the pursuit, attack, prey penetration and feeding methods of *C. tuberosa* and *Cypraecassis testiculus*. Tonnacean proboscis gland (PG) secretion is compared with accessory boring organ (ABO) secretion of the Naticidae and Muricidae.

The Cassidae are mainly nocturnal predators that feed specifically on echinoids; diets probably reflect the availabilities of specific echinoids in the habitat. The basic design of the alimentary system is similar to that of other tonnacean families. Two large proboscis glands deliver a secretion rich in sulfuric acid ( $\text{pH} < 1$ ) via long ducts that pass through the nerve ring, along the proboscis to the buccal cavity. Prey are gripped by the foot and penetration of the test is achieved within about 10 min by the combined action of sulfuric acid and the radula. Scanning electron micrographs reveal severe etching, but no radular marks, on the cut edges of the test. Prey do not appear to be anaesthetized during attack. Consumption of internal tissue takes about 1–2 hr, but the feeding time can be more than doubled when all external tissue and spines are eaten. There appears to be no size selection of prey.

ABO secretion of naticids and muricids, which drill bivalves, and tonnacean PG secretion both dissolve minerals with the aid of an inorganic acid and probably a chelating agent. PG secretion, however, is much more acidic and is produced in far greater quantities than ABO secretion, and may lack the ability of the latter to attack the organic matrix of calcareous skeletal material prior to mineral dissolution.

### INTRODUCTION

The beautiful shells of the Cassidae (helmet shells) have attracted attention almost to the total exclusion of the living animals. Yet these mesogastropods, which have a world-wide distribution in tropical to warm temperate sand and reef habitats, are intriguing not only because of their shells, but also because they feed almost exclusively on echinoids. In spite of this rather bizarre diet for a gastropod, accounts of the feeding biology of cassids were, until recently, confined to brief notes scattered in various journals. In the present paper, we have synthesized information from the literature and present new data on the feeding methods of the Cassidae. Where relevant, we have also included published information on the Cymatiidae, Bursidae and Tonnidae that together with the Cassidae and Ficidae comprise the superfamily Tonnacea. Our review deals sequentially with the anatomy of the feeding ap-

paratus, properties of the associated glands and their secretions, mode of attack, penetration and consumption of prey.

### ANATOMY

The general plan of the alimentary system is similar throughout the Tonnacea, useful recent accounts being those of Day (1969) for *Argobuccinum*, and Houbrick & Fretter (1969) for *Cymatium* and *Bursa*. Reynell's (1905) anatomical description of *Galeodea* (= *Cassidaria*) *rugosa* (L.) suffers from poorly reproduced diagrams. The description of the cassid alimentary system given here is based on new data for *Cassis tuberosa* (L.) (Fig. 1a, b).

#### Proboscis and buccal apparatus

The mouth and buccal mass lie at the tip of the proboscis (Fig. 1, P) which, when fully ex-

tended, is 1 to 1.5 times the length of the shell, and when retracted lies within the proboscis sheath whose entrance forms a false mouth or rhynchodeum (RH). Retractor muscles running longitudinally in the proboscis wall become free in the proximal region of the proboscis, forming strap-like connections (PRM) with the walls of the cephalic haemocoel (CH). Retraction of the proboscis therefore involves both shortening, due to contraction of muscles in the proboscis wall, and inversion of the proximal region due to contraction of the free retractor muscles. The Cymatiidae lack free retractor muscles, and retraction occurs solely by contraction of the proboscis wall (Day, 1969; Houbrick & Fretter, 1969). The tonnacean proboscis is therefore rather different from the pleurembolic type of most neogastropods, where retractor muscles lying freely within the proboscis cavity are inserted along the length of the buccal mass (Day, 1969). The bulk of the retracted proboscis and the huge proboscis glands are compensated by reductions in the pallial organs in the anterior half of the pallial cavity. The hypobranchial gland becomes thin towards its anterior end and the anus is posi-

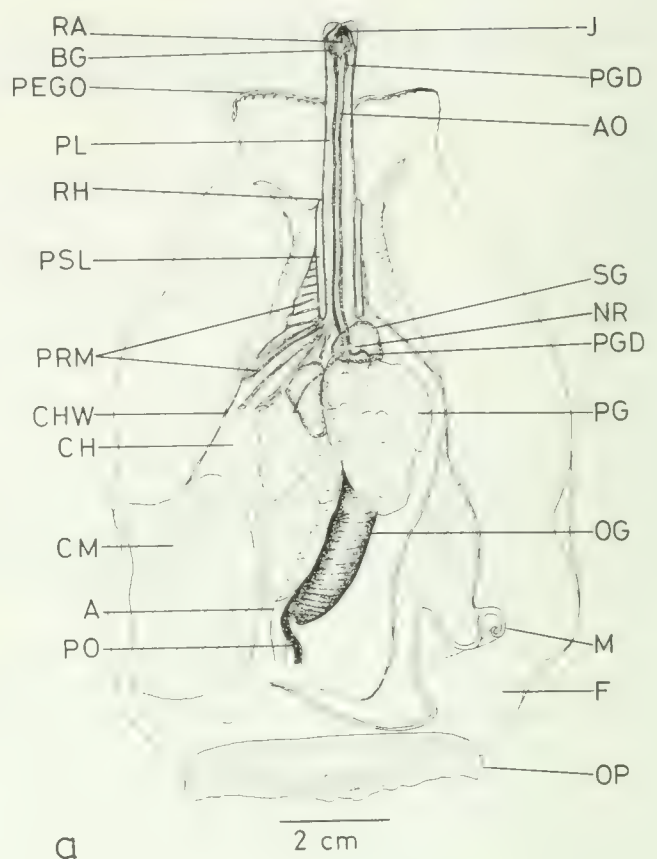

a

FIG. 1. **a.** *Cassis tuberosa*. The visceral mass, mantle and dorsal wall of the cephalic haemocoel have been removed to reveal the feeding apparatus and associated glands. A aorta, AO anterior esophagus, BG buccal gland, CH cephalic haemocoel, CHW cephalic haemocoel wall, CM columella muscle, F foot, J jaw, M mantle, NR nerve ring, OG esophageal gland, OP operculum, PEGO pedal gland opening, PG proboscis gland, PGD proboscis gland duct, PL proboscis lumen, PO posterior esophagus, PRM proboscis retractor muscle, PSL proboscis sheath lumen, RA radula, RH rhynchodeum, SG salivary gland. **b.** *Cassis tuberosa* removed intact from its shell. DG digestive gland, E eye, HG hypobranchial gland, K kidney, P proboscis, PS proboscis sheath, S stomach; other symbols as for Fig. 1a.

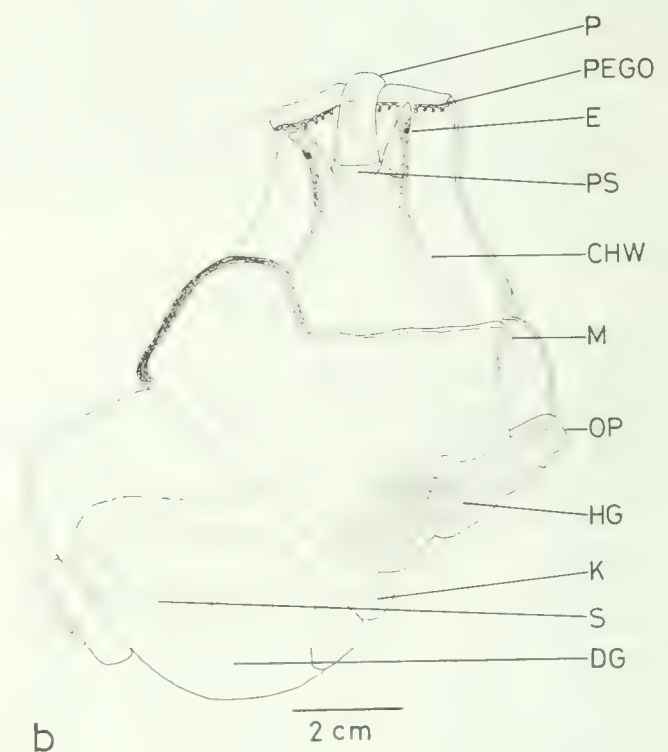

b

FIG. 2. **a.** *Tripneustes ventricosus* drilled by *Cassis flammea*, which had swallowed half the spines; **b.** *T. ventricosus* drilled by *Cassis tuberosa*. An area of spines has been cleared and a hole made in the test by cutting out a disc, which can be seen still in place. This urchin was removed from the *C. tuberosa* 10 min after the initial attack; **c.** Edge of hole in (b), showing undercutting caused by erosion by sulfuric acid; **d.** edge of disc showing severe etching by sulfuric acid; white areas are unetched surface material; **e.** higher magnification of spine boss in (d), showing severe etching; **f.** jaw of *Cassis flammea*; **g.** radula of *Cassis tuberosa*; **h.** central (rachidian) teeth showing wear on median cusps; **i.** marginal teeth; **c-i** are scanning electron micrographs.



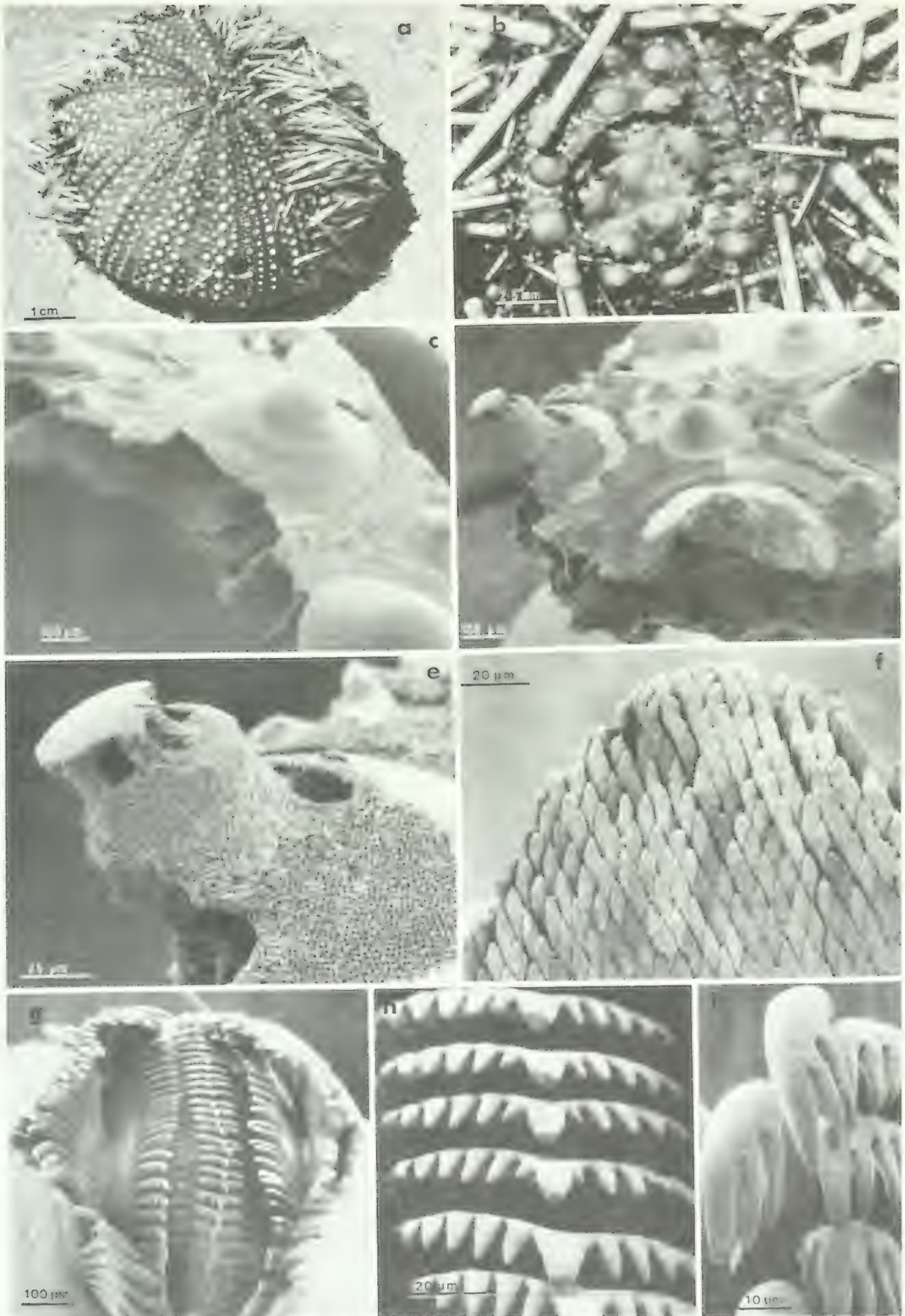

tioned much further back than in other mesogastropod superfamilies.

The buccal mass, anchored within the tip of the proboscis by fine radiating muscles, contains a pair of horny jaws (J), the radula (RA) and associated odontophore, a region of glandular tissue (BG) behind the odontophore, and the openings of the paired proboscis gland ducts. Each jaw forms a bluntly pointed plate comprised of rows of contiguous rods, the distal ends of which form diamond-shaped subunits, giving the outer surface of the jaw a 'snake-skin' appearance. Instead of having a sharp saw-toothed edge as in *Cymatium* or *Charonia*, the jaw of *Cassis* has a blunt, rounded edge suitable for gripping spines and strands of flesh (Fig. 2f).

The radula has 7 teeth per transverse row, comprised of a central (rachidian) tooth on either side of which are a lateral and two marginal teeth (Fig. 2g). The central and lateral teeth are heavily cusped (Fig. 2h), whereas the marginal teeth are more delicately armed with 3 to 4 cusps arranged to form a claw (Fig. 2i). Ontogenetically, the marginal teeth become functional before the central and lateral teeth, and are used to grip shreds of flesh by intermeshing as the radula rolls backwards over the bending plane of the odontophore. More distally along the radula, the central and lateral teeth are used to rasp the calcareous tests of urchins, as a consequence of which their cusps become worn (Fig. 2h) and the delicate marginal teeth become torn away.

The buccal glandular tissue (BG) may be homologous to the "partly paired buccal gland" described in *Argobuccinum argus* (Gmelin) by Day (1969), to the "glandular patches" described in *Bursa granulatis* (Röding) by Houbriek & Fretter (1969) and to the "blindsack" of *Tonna galea* (L.) (Weber, 1927). These glandular structures are of unknown function. Also opening into the buccal cavity are the paired proboscis gland ducts that deliver a secretion rich in sulfuric acid used to etch the calcium carbonate tests of urchins (Fig. 2 c-e).

#### Alimentary canal

On leaving the buccal mass, the anterior esophagus (Fig. 1a, AO) forms a narrow tube with dorsal and ventral typhlosoles, and runs along the proboscis, finally dropping sharply downwards through the nerve ring (NR). On emerging from the nerve ring, the esophagus

immediately bends dorsalwards, whereupon its upper side is modified into the septate esophageal gland (OG), which runs alongside the aorta (A) beneath the proboscis glands (PG), almost for the remaining length of the cephalic haemocoel. The repeated transverse folds of the esophageal gland are richly supplied with secretory cells that in *Argobuccinum argus* are of three types, one secreting mucus and the others secreting unidentified digestive enzymes (Day, 1969).

The posterior esophagus (PO), which is a simple ciliated tube with thick muscular walls, leaves the esophageal gland and opens into the U-shaped stomach (Fig. 2b, S). The large digestive gland (DG) is connected to each limb of the stomach by separate ducts. The short intestine emerges, without sharp distinction, from the stomach and runs forward through the kidney sac (K) to the muscular rectum and anus.

#### Proboscis glands

The proboscis gland ducts (Fig. 1a, PGD) run from the buccal mass along either side of the esophagus, through the nerve ring, to the relatively massive glands lying in the cephalic haemocoel. This anatomical feature is unique to the Tonnacea. Each proboscis gland consists of 2 to 3 lobes, the right gland being considerably smaller and placed more centrally and further forward than the left gland beneath it (Fig. 1a). The proboscis glands are covered by an intricate network of muscles, the contraction of which forces the secretion through the proboscis gland ducts into the buccal cavity. The glands are anchored by fine muscle strands connecting to the body wall and foot.

The proboscis gland's histology has been described by Nüske (1973) for *Galeodea* (= *Cassidaria*) *echinophora* (Lamarck) and by Day (1969) for *Argobuccinum argus*. The following account is synthesized from both sources. Each gland consists of numerous tubules draining into collection ducts (Fig. 3a). The tubule walls are made of a single layer of large cells that produce the acid secretion (Fig. 3b). Nüske (1973) recognized three phases of cellular secretion. During secretion formation, large vacuoles are formed in the apical cell region by confluence of smaller vacuoles appearing to originate from the Golgi apparatus. The cells increase in size and attain a smooth boundary at the lateral and basal sides where they were previously

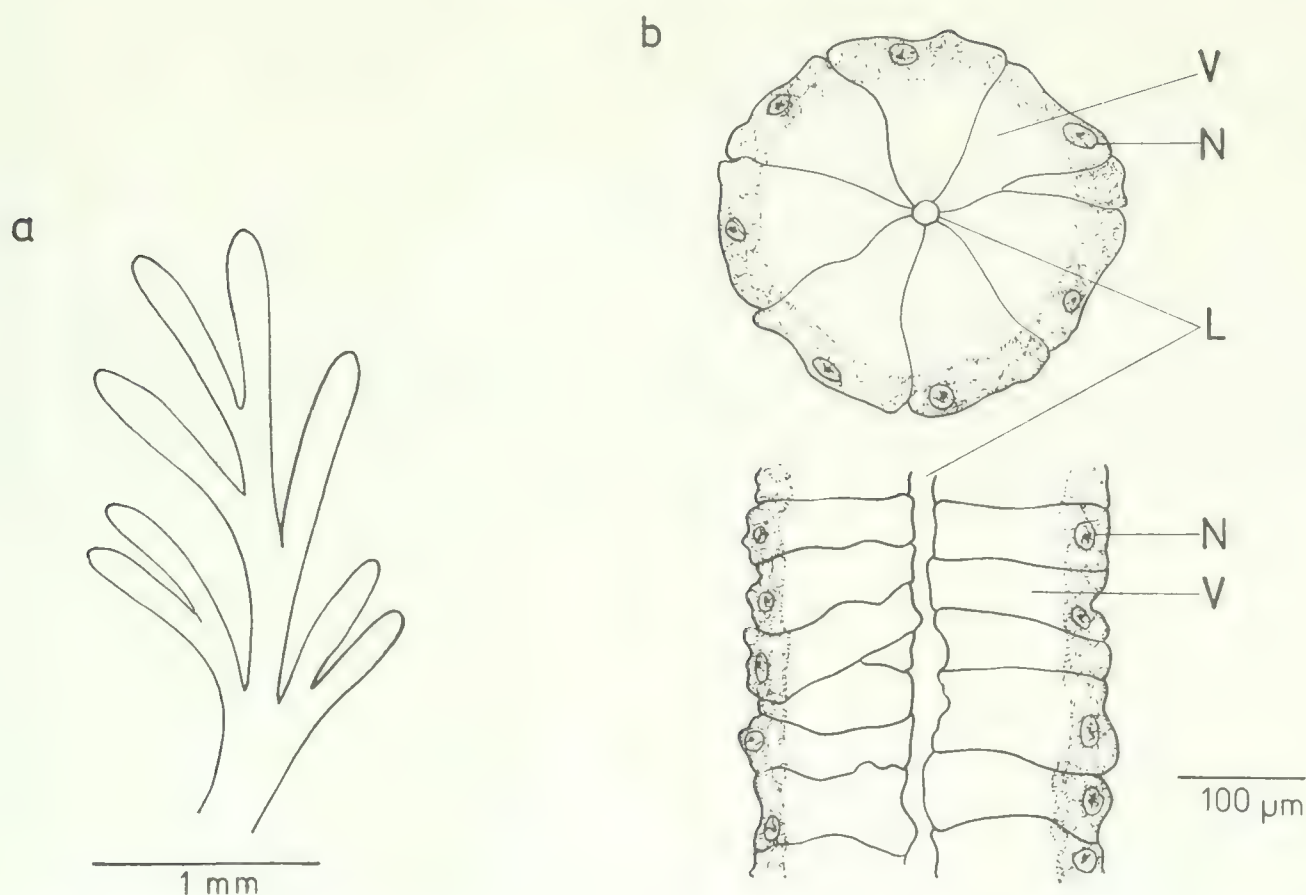

FIG. 3. **a.** dissected tubules of proboscis gland of *Argobuccinum argus* (after Day, 1969); **b.** transverse and longitudinal sections of PG tubules of *Galeodea echinophora* (after Nüske, 1973). L tubule lumen, N nucleus, V secretion vacuole.

thrown into interdigitating folds. These folds may represent a plasma membrane reservoir for the enlargement of the cells during secretion formation. When full, the cells are each occupied by one or a few large secretion vacuoles. The nucleus, cytoplasm, organelles and abundant small vacuoles are confined to the basal layer (Fig. 3b). After liberation of the apical secretion vacuole, the cytoplasm, containing numerous small vacuoles, becomes evenly spread throughout the entire cell. Meanwhile the cells shrink and become extensively folded along their lateral and basal sides. New secretion vacuoles appear within a few hours after the proboscis glands have been emptied (Nüske, 1973).

#### Proboscis gland secretion

The chemical properties of the proboscis gland secretion have been studied for *Galeodea echinophora* by Fänge & Lidman (1976) and for the cymatiid *Argobuccinum argus* by Day (1969), these recent analyses agreeing closely with the much earlier study of Panceri (1869) on *Tonna galea* and *G. echinophora*. The proboscis gland secretion

of *G. echinophora* is hypertonic to seawater, with a pH of about 0.13. Hydrogen and sulfate ions are the predominant components, while sodium and chloride concentrations are lower than in the blood, and potassium and magnesium concentrations equal those in seawater. Only minute traces of organic material are present, and in this respect the Cassidae may differ from the Cymatiidae and Bursidae that are known to secrete toxins that anaesthetize the prey (Asano & Itoh, 1960; Day, 1969; Houbrick & Fretter, 1969). The secretion of the cymatiid, *A. argus*, has a pH of 1.1, and consists largely of 0.4–0.5 N sulfuric acid. Day (1969) established that the secretion contains no enzymes involved with the dissolution of calcium carbonate, but that 33% of the calcium carbonate (bivalve shell) dissolved by experimentally administered secretion was attacked by some component other than sulfuric acid, probably a chelating agent. How the proboscis gland cells store the strongly acid secretion without cellular damage, and the nature of the physical-chemical pathways which produce such high concentrations of hydrogen and sulfate ions, remain unknown.

TABLE 1. Recorded prey of the Cassidae.

Predator	Prey type	Prey species	Locality	Authority
<i>Cassia tuberosa</i> (L.)	epifaunal echinoids	<i>Tripneustes ventricosus</i> (Lamarck)	Florida Keys aquarium, Florida aquarium, Barbados Barbados	Moore, 1956 Work, 1969 Hughes & Hughes, 1971 present study
		<i>Lytechinus</i> (= <i>Toxopneustes</i> ) <i>variegatus</i> (Lamarck)	aquarium, Bimini, Bahamas Florida	Robertson quoted by Abbott, 1968a Lyman, 1937
	burrowing echinoids	<i>Diadema antillarum</i> (Philippi)	Virgin Islands aquarium, Florida Bimini, Bahamas	Schroeder, 1962 Gladfelter, 1978 Work, 1969 Snyder & Snyder, 1970
		<i>Echinometra lucunter</i> (L.)	aquarium, Barbados aquarium, Florida aquarium, Florida Virgin Islands	Hughes & Hughes, 1971 Work, 1969 Work, 1969 Gladfelter, 1978
		<i>Arbacia</i> sp.		
		<i>Cassidulus cariboeorum</i> Lamarck	Bimini, Bahamas aquarium, Florida	Foster, 1947 Work, 1969
		<i>Clypeaster rosaceus</i> (L.)		
		<i>Clypeaster subdepressus</i> (Gray)		
		<i>Mellita quinquesperforata</i> (Leske)	aquarium, Florida	Work, 1969
		<i>Echinoneus</i> sp.	aquarium, Florida	Work, 1969
		<i>Moira</i> sp.	aquarium, Florida	Work, 1969
		<i>Plagiobrissus grandis</i> (Gmelin)	aquarium, Florida	Work, 1969
	<i>Meoma ventricosa</i> (Lamarck)	aquarium, Florida	Work, 1969	
<i>Cassia madagascariensis</i> (Lamarck)	epifaunal echinoids	<i>Lytechinus</i> (= <i>Toxopneustes</i> ) <i>variegatus</i> (Lamarck)	Florida	Lyman, 1937
	burrowing echinoids	<i>Plagiobrissus grandis</i> (Gmelin)	Florida Keys, unspecified locality	Moore, 1956, Chesher, 1969
		<i>Meoma ventricosa</i> (Lamarck)	Caribbean, unspecified locality	Chesher, 1969
<i>Cassia flammea</i> (L.)	epifaunal echinoids	<i>Echinometra lucunter</i> (L.)	aquarium, Barbados	Hughes & Hughes, 1971
		<i>Tripneustes ventricosus</i> (Lamarck)	aquarium, Barbados	Hughes & Hughes, 1971
	burrowing echinoid	unidentified spatangoid	Barbados	present study (circumstantial evidence)

<i>Cassia cornuta</i> (L.)	epifaunal echinoid	<i>Diadema setosum</i> (Leske)	Barrier Reef, Australia	Endean, 1972, 1973
	asteroid?	<i>Acanthaster planci</i> (L.)	Barrier Reef, Australia	Endean, 1969 (unsubstantiated report)
<i>Cassia tessellata</i> (Gmelin) (= <i>C. spinosa</i> Gronovius)	asteroid	<i>Oreaster clavatus</i> Muller & Troschel	aquarium, Ghana	Edmunds & Edmunds, 1973
<i>Cypraeacassis testiculus</i> (L.)	epifaunal echinoids	<i>Lytechinus</i> (= <i>Toxopneustes</i> ) <i>variegatus</i> (Lamarck)	Florida	Lyman, 1937
		<i>Echinometra lucunter</i> (L.)	Panama	Hendler, 1977
			aquarium, Barbados	present study
			aquarium, Florida	McPherson, 1968
			Panama	Hendler, 1977
		<i>Echinometra viridis</i> Agassiz	Panama	Hendler, 1977
		<i>Tripneustes ventricosus</i> (Lamarck)	aquarium, Barbados	present study
		<i>Diadema antillarum</i> (Philippi)	aquarium, Barbados	present study
		"wide variety" of unspecified echinoids	aquarium, Florida	Work, 1969
		<i>Eucidaris tribuloides</i> (Lamarck)	aquarium, Florida	Work, 1969
	burrowing echinoids	<i>Echinoneus cyclostomus</i> Leske	Panama	Hendler, 1977
		<i>Brissus unicolor</i> Agassiz	Panama	Hendler, 1977
<i>Cypraeacassis rufa</i> (L.)	epifaunal echinoids	<i>Tripneustes</i> (= <i>Toxopneustes</i> ) <i>pileolus</i> (Lamarck)	Addu Atoll, Maldives	Taylor, 1978 (circumstantial evidence)
		unspecified "short spined" sea urchins	Maziwi Island, Tanzania	Yaninek, 1978
		<i>Echinometra vanbrunti</i> A. Agassiz	East Africa	Spry, quoted by Abbott, 1968a
<i>Cypraeacassis coarctata</i> (Sowerby)	epifaunal echinoid	<i>Echinometra vanbrunti</i> A. Agassiz	Sayulita, Mexico	Boone, personal communication
<i>Phalium granulatum</i> (Born)	burrowing echinoids	<i>Mellita quinquesperforata</i> (Leske)	Florida Keys	Moore, 1956
		<i>Cassidulus cariboeorum</i> Lamarck	Virgin Islands	Gladfelter, 1978 (circumstantial evidence)
<i>Phalium labiatum</i> (= <i>zeylanicum</i> ) (Lamarck)	burrowing echinoid	<i>Echinodiscus bisperforatus</i> (Leske)	South Africa	Day, 1969
	bivalves?	unspecified (may be speculative)	South Africa	Day, 1974
<i>Phalium bisulcatum</i> (Schubert & Wagner)	burrowing echinoid	<i>Rhinobrissus hemiasteroides</i> A. Agassiz	Eniwetok lagoon	Kenzler, quoted by Abbott, 1968a (circumstantial evidence)
<i>Phalium semigranosum</i> (Lamarck)	bivalves?	unspecified (may be speculative)	Australia	Macpherson & Gabriel, 1962 cited by Abbott, 1968

### Salivary glands

Partially embedded in the anterior lobe of each proboscis gland is a much smaller acinar salivary gland (Fig. 2a, SG). It has commonly been assumed that the salivary glands empty into the proboscis gland ducts, but Day (1969) found that the salivary glands of *Argobuccinum argus* empty directly into the esophagus immediately before the esophageal gland. Nüske (1973) described the salivary gland of *Galeodea echinophora* as consisting of mucus-secreting cells and "canaliculi" cells. The latter are characterized by intercellular canaliculi densely filled with microvilli and cilia, and Nüske (1973) suggested that they may produce the chloride component of the secretion emptying into the buccal cavity. This interpretation would seem to be erroneous if, as in *A. argus*, the salivary glands of cassids empty by separate ducts into the esophagus. Moreover, Fänge & Lidman (1976) found chloride to be present only in low concentrations in the secretion ejected from the proboscis of *G. echinophora*. Day (1969) claims that the salivary glands of *Argobuccinum argus* have a high amylase activity.

### THE DIET

Records of prey taken by cassids are summarized in Table 1, from which it is evident that with very few exceptions, the Cassidae feed exclusively on echinoids. The exceptions are as follows. *Morum oniscus* (L.), not listed in Table 1, failed to eat any kind of echinoderm when an exhaustive series was offered in the laboratory (Work, 1969). *Cassis cornuta* (L.) was reported by a shell collector to eat the crown of thorns starfish *Acanthaster planci* (L.) (cited in Endean, 1969), and presumably this was the origin of Profant's (1970) claim that *C. cornuta* eats *A. planci*. Endean (1973), however, thought that the observer may have mistaken the urchin *Diadema setosum* (Leske) (known prey of *C. cornuta*) for *A. planci*. *Cassis tessellata* (Gmelin) (= *C. spinosa* Gronovius) "rasped away" at the asteroid *Oreaster clavatus* Muller & Troschel in captivity (Edmunds & Edmunds, 1973), but the success of this feeding attempt was not reported and the incident may have been induced by artificial conditions in the aquarium. *Phalium labiatum* (Lamarck) and *Phalium semigranosum* (Lamarck) are both reputed to feed on bivalves. The mol-

luscan diet of *Phalium* is unsubstantiated and the reports may be speculative, since bivalves are common in the sandy areas populated by those cassids. *Phalium* spp. might be capable of drilling bivalve shells since the secretion of the cymatiid *Argobuccinum argus* etches *Macoma* sp. shells (Day, 1969). Nevertheless, bivalves have not been recorded in the diet of the better known species *Phalium granulatum* (Born).

A wide range of echinoids is consumed by the Cassidae, and diets seem to reflect the common species of urchin present in the habitat. Only stout-spined urchins such as *Eucidaris tribuloides* (Lamarck) tend to be avoided, although this species has been recorded in the natural diet of *Cypraecassis testiculus* (Hendler, 1977) and is readily taken by the cymatiid *Charonia variegata* Lamarck (McPherson, 1968; Work, 1969). Cassids living on sea-grass beds or near reefs feed on epifaunal echinoids, whereas populations of the same species living on soft substrata feed on burrowing echinoids. *Phalium* spp. always inhabit sandy substrata where they feed on burrowing echinoids, notably clypeastroids. Possibly, individuals become conditioned to specific echinoid prey. In the present study, *Cassis tuberosa* fed readily in the laboratory on *Tripneustes ventricosus* (Lamarck) and *Echinometra lucunter* (L.), but ignored *Diadema antillarum* (Philippi). However, Schroeder (1962), Snyder & Snyder (1970) and Gladfelter (1978) recorded *C. tuberosa* feeding on *D. antillarum* in the field. Of four *C. testiculus* (L.) that we collected from a single locality in Barbados, one fed rapaciously on *D. antillarum*, whereas the other three readily attacked *T. ventricosus* and *E. lucunter* but would not attack *D. antillarum*. However, they occasionally fed communally on *D. antillarum* that had been overcome by the first *C. testiculus*. Perhaps the technique of attacking the active, long-spined *D. antillarum* has to be learned.

Diets of newly settled or newly hatched cassids are unknown. They may feed on very small juvenile echinoids, but it is possible that they subsist on other, more readily available, invertebrate taxa.

On three occasions in the laboratory, *Cassis tuberosa* were seen to stop hunting and to twist the head back along the side of the shell aperture, extending the proboscis to reach the highest parts of the shell (Fig. 4d). The proboscis plucked at the shell surface as if to remove the algae growing there. The pur-

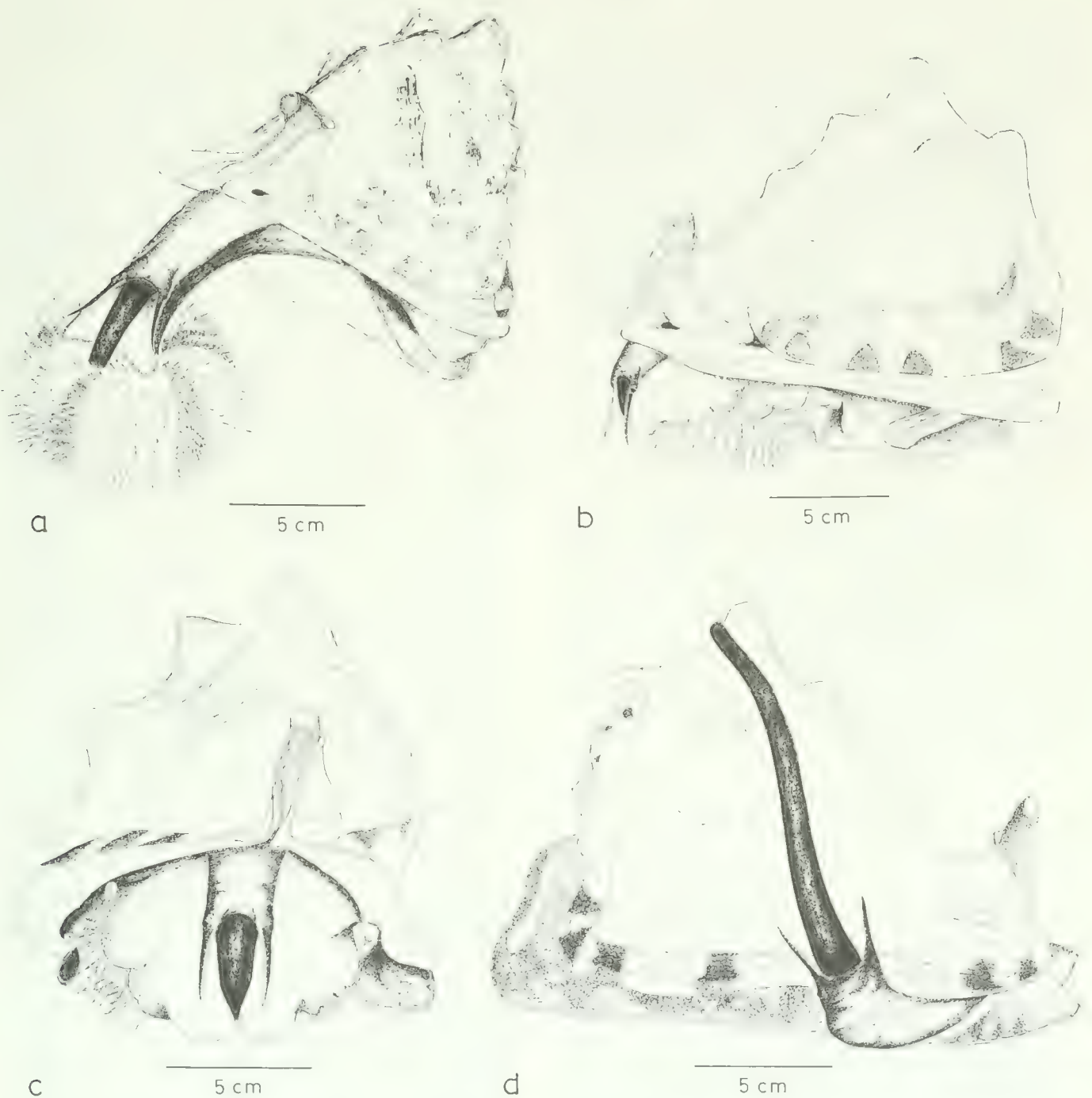

FIG. 4. **a.** *Cassis tuberosa* arching over *Tripneustes ventricosus* in initial phase of attack; **b.** urchin grasped by front part of foot; **c.** a groove between lobes of foot supports proboscis during penetration and feeding; **d.** extension of proboscis to 'clean' shell surface.

pose of this behaviour remains a mystery, as removal of the algae would detract from the camouflage they provide; the possibility that the algae supply some essential nutrients, not available from the prey, seems unlikely.

#### FEEDING METHODS AND BEHAVIOUR

The following account of feeding methods is based largely on observations of 4 individ-

uals of *Cassis tuberosa*, 1 of *C. flammea* (L.) and 4 of *Cypraeacassis testiculus* collected in Barbados during April 1980. The animals were kept at about 29°C in a shallow concrete tank (3.95 m long and 0.76 m wide) filled to a depth of 18 cm with running seawater. The *C. testiculus* were partitioned off in an area of the tank and provided with a 4 cm layer of sand. Observations were made throughout the night using a dimmed torch.

### Hunting behaviour

*Cassis* spp. and *Cypraeacassis testiculus* seldom moved during daylight, remaining partially (*Cassis* spp.) and wholly (*C. testiculus*) buried in sand when it was available. Animals began feeding at various times throughout the night, but generally ceased feeding at daybreak. The single specimen of *Cassis flammea* was exceptional because, during the day, it often remained feeding on urchins that it had attacked the previous night. In contrast to these observations, Boone (personal communication) saw *Cypraeacassis coarctata* (Sowerby) feeding on urchins during the day in the field. The typically nocturnal feeding habits of the Cassidae are paralleled by those cymatiids that feed on mobile prey (Houbrick & Fretter, 1969; Laxton, 1971). Diurnal feeding apparently occurs only in sluggish cymatiids that 'graze' on sedentary invertebrates (Laxton, 1971). While hunting, *Cassis tuberosa* moves steadily at a speed of about 0.3 cm per second, turning only gradually during its trajectory. The much smaller *Cypraeacassis testiculus* moves at a speed of about 0.5 cm per second, with frequent erratic turns.

### Method of attack

*Cassis* spp. and *Cypraeacassis testiculus* have quite different attack methods. *C. tuberosa* detects prey by olfaction, and when it approaches to within a few cm of an urchin, the siphon bends forward and the tentacles become fully extended. Just before tentacular contact is made, the front edge of the foot is raised slightly. As soon as the tentacles touch the urchin, the front half of the foot is raised in a high arch so that the shell is inclined at an angle of about 30°. *C. tuberosa* continues to move forwards on the hind portion of its foot, at the same time extending its head over the urchin (Fig. 4a). During this maneuver, which usually takes less than 10 sec, no contact is made with the urchin except for very brief delicate touches by the tentacles. This is important, because most epifaunal urchins can move faster than *C. tuberosa* and would often escape if alarmed before they were covered by the predator. Such escapes were observed frequently in the laboratory, the urchins apparently alarmed by the scent of the approaching *C. tuberosa*. Snyder & Snyder (1970) however, found that *Diadema antillarum* were unresponsive to *C. tuberosa*

placed upcurrent in the field, but reacted violently when touched by the predator. Schroeder (1962) maintained that in the field, pursuits of fleeing *D. antillarum* by *C. tuberosa* were usually successful.

When the urchin is adequately covered, *Cassis tuberosa* drops down on the prey, grasping it with the bilobed front portion of the foot (Fig. 4b). The lobes of the foot provide a secure hold on the urchin and the groove between them supports the proboscis during penetration and feeding. The proboscis is also supported during feeding by folds in the front edge of the foot in *Cypraeacassis testiculus* (Fig. 5b, c), *Charonia* spp. (Laxton, 1971) and *Cymatium nicobaricum* (Röding) (Houbrick & Fretter, 1969). Schroeder's (1962) description of the attack behaviour of *C. tuberosa* feeding in the field on *Diadema antillarum* agrees with ours of *C. tuberosa* feeding on *Tripneustes ventricosus* and *Echinometra lucunter*, except that when feeding on *D. antillarum*, *C. tuberosa* repeatedly inserts its proboscis among the spines while arching over the prey. *D. antillarum* is a particularly agile urchin, and it is possible that *C. tuberosa* administers a toxin among the spines to hinder the urchin's retreat. It is uncertain, however, whether cassids are able to secrete toxins.

Our single specimen of *Cassis flammea* did not arch over its prey, but tried to mount urchins directly, with the result that many of them escaped. When successful, *C. flammea* gripped the side, or at most, only half the upper surface of the urchin with the front of its foot. This specimen of *C. flammea* was collected on a fine sand substratum where the only potential echinoid prey were spatangoids and clypeastroids. Although we could not induce the *C. flammea* to eat *Mellita quinquesperforata* (Leske) or large *Meoma ventricosa* (Lamarck) in the laboratory, it is likely that it had been feeding on burrowing echinoids in the field; these prey may require a different attack method than epifaunal echinoids. Moore (1956) described how, when feeding on the large burrowing urchin *Plagiobrissus grandis* (Gmelin), *Cassis madagascariensis* (Lamarck) burrows downwards at a steep angle through the sand and clasps the echinoid in the front part of its foot. Moore (1956) also found *Phalium granulatum* feeding on *M. quinquesperforata*; the predators were perched on top of their prey and had penetrated the test near the centre of the aboral surface. Kier (personal communica-



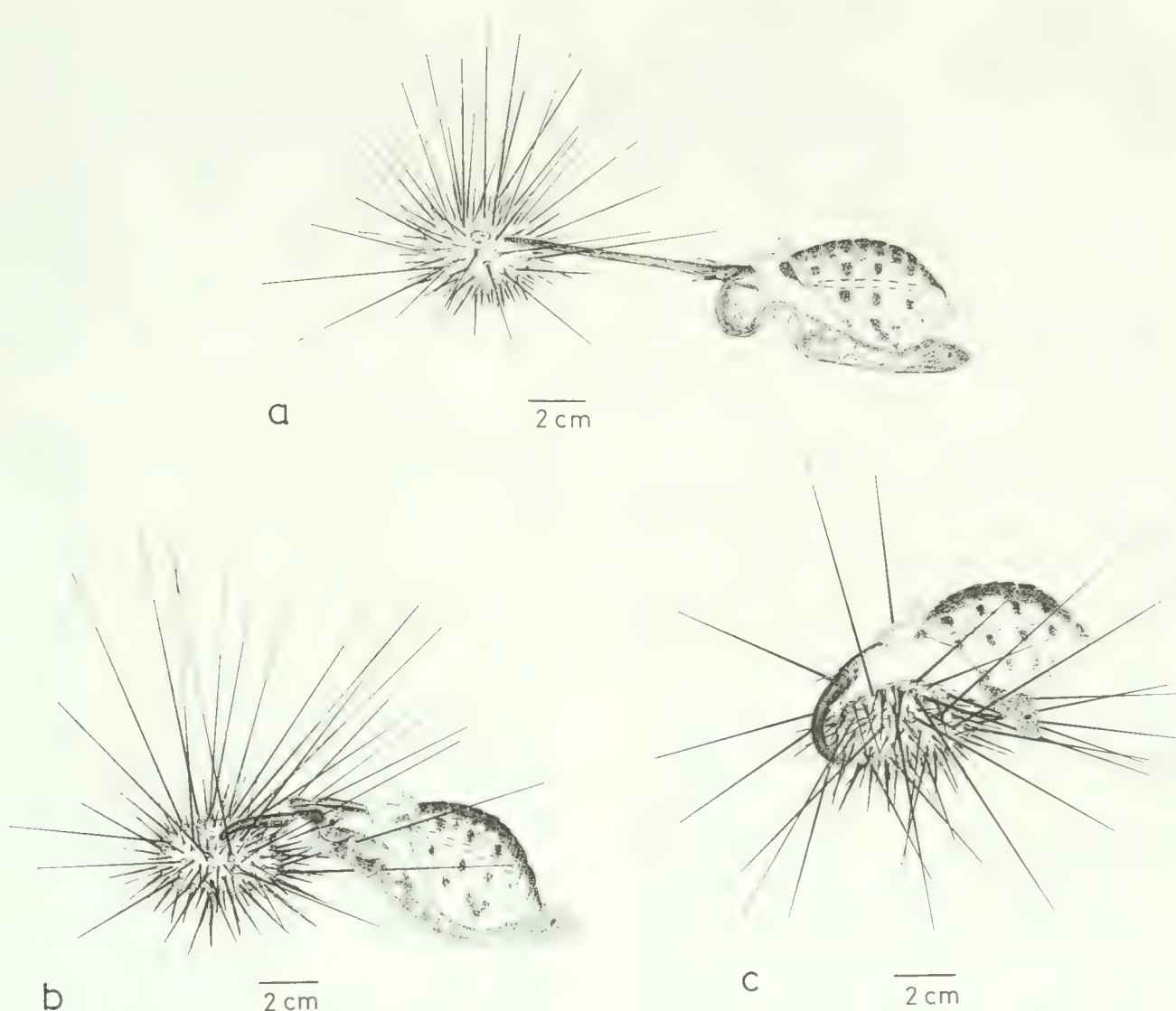

FIG. 5. **a.** *Cypraecassis testiculus* shooting out its proboscis in initial attack on *Diadema antillarum*; **b.** spines are gripped by front part of foot; **c.** *Cypraecassis* mounts urchin and commences feeding.

tion) recorded, by time lapse photography, the feeding of *P. granulatum* on the burrowing echinoid *Cassidulus cariboeorum* Lamarck. After moving about the aquarium for several hours of the night, *P. granulatum* stopped and burrowed partially into the sediment. After 8 minutes a dead denuded *C. cariboeorum* appeared at the surface and *P. granulatum* resumed locomotion. This represents an outstandingly rapid attack procedure that clearly deserves further study. The film also revealed that *C. cariboeorum* sensed the approach of *P. granulatum* and responded by surfacing and moving away as fast as possible.

*Cypraecassis testiculus* is able to detect echinoids by olfaction from at least 30 cm downstream in a weak current. Once detected, the prey are approached swiftly and directly. On making first tentacular contact with *Tripneustes ventricosus* and *Echinometra lucunter*, *C. testiculus* extends its proboscis

and applies it repeatedly to the test among the spines, penetration commencing within 1–2 min. Meanwhile, the spines are grasped by the forepart of the foot, and by the time penetration is well underway, *C. testiculus* has the urchin securely enveloped. Urchins under attack wave their tube feet and spines wildly, and *C. testiculus* is frequently dragged 30–50 cm before the prey becomes incapable of further locomotion.

*Diadema antillarum* elicits a rather different attack behaviour. When 1–2 shell lengths away from the urchin, *Cypraecassis testiculus* quickly shoots out its proboscis and applies it repeatedly to the periproct (Fig. 5a). The urchin invariably reacts by violently waving its spines and tube feet, retreating hastily. Often, *C. testiculus* is able to gain on the retreating *D. antillarum* and to grasp its spines with the front of the foot, whereupon the attack always succeeds (Fig. 5b, c). Sometimes

*D. antillarum* escapes before *C. testiculus* is able to grasp the spines. In the confines of the laboratory aquarium, a chase ensues that may involve several unsuccessful attacks, but usually ends in victory. The swift application of the fully extended proboscis when *C. testiculus* attacks *D. antillarum* is reminiscent of the probing action of the proboscis of *Cassia tuberosa* when it also attacks this species, again suggesting that a toxin is being delivered to hinder the retreat of such a mobile prey.

#### Secretion of toxins

The reputation of the Cassidae for secreting toxins derives both from inference, since certain other members of the Tonnacea are known to produce toxins, and from the experiments of Cornman (1963), who found that the secretion delivered from the proboscis of *Cassia tuberosa*, when diluted to 1/1000, would incapacitate the spines and tube feet of *Diadema antillarum* immersed in the solution. We examined the mobility of spines and tube feet of numerous urchins under attack from *Cassia* spp. and *Cypraeocassis testiculus*, but could find no evidence for action of a toxin. Spines and pedicellariae remained active throughout the attacks, and remained active for some time even after all internal tissue had been eaten. The tube feet remained active and retained their ability to attach themselves to the substratum for at least 10 min after the initial attack, by which time penetration of the test was usually achieved. After this time, there was a tendency for the tube feet on certain ambulacra to curl up and lose their response to touch, while those on other ambulacra remained active. Internal examination of the tests showed that the ampullae had been stripped from those ambulacra with inactive tube feet.

It is still possible, however, that cassids produce a toxin that interferes with the co-ordination of the spines and tube feet, thus impeding locomotion without inhibiting their activity. Such a subtle effect would be hard to detect experimentally. By contrast, cymatiids and bursids such as *Argobuccinum argus* (Day, 1969), *Cymatium nicobaricum* and *Bursa* spp. (Houbrick & Fretter, 1969) produce toxins that have very marked anaesthetic effects on their prey. Moreover, the toxin produced by *Fusitriton* (= *Argobuccinum*) *oregonensis* (Redfield) has been identified as tetramethylammonium tetramine

(Asano & Itoh, 1960). Cymatiid toxin appears to be secreted by the proboscis gland, as Laxton (cited by Edean, 1972) found that extract only from the posterior segment of the "salivary" gland of *Charonia rubicunda* (Perry) would paralyse starfish. Fänge & Lidman (1976), however, found only minute traces of organic material in the secretion of *Galeodea echinophora*. The ability of cassids to produce toxins thus remain open to question.

#### Role of mucus

While handling its prey, *Cassia tuberosa* secretes a thick layer of stiff mucus from the transverse slit along the front edge of the foot (Fig. 1a, b, PEGO). The prey's spines become flattened down, all facing away from the area of penetration, under the layer of mucus by gradual pressure from the predator's foot. In this way, the spines do not damage the snail. Pedicellariae become detached and trapped in the mucus, thereby rendered harmless. Copious quantities of mucus are also secreted by *Cypraeocassis testiculus*, as a result of which the snail is able to climb onto its prey without damage from spines and pedicellariae. Mucus is an important agent in the attack method of other tonnaceans. *Cymatium nicobaricum* secretes a thick, resilient curtain of mucus over the aperture of its gastropod prey, thus forming a seal around the proboscis which is inserted into the lumen of the prey's shell (Houbrick & Fretter, 1969).

### PENETRATION OF THE PREY

#### Position of penetration

Cassids usually penetrate their prey through the test, but sometimes entry is gained through the membranous peristome, or in the case of *Diadema antillarum*, through the periproct. The diameter of the hole made in the test reflects the size of the predator, being about 9 mm for adult *Cassia mada-gascariensis*, 5–6 mm for *C. tuberosa*, 3–4 mm for *C. flammea*, 2–3 mm for *Cypraeocassis testiculus* and 1–3 mm for *Phalium granulatum*. Penetration may occur anywhere on the test, but some regions are penetrated more frequently than others. Hughes & Hughes (1971) found that *Cassia tuberosa* feeding on *Tripneustes ventricosus* and *Echinometra lucunter* penetrated about 50% of the urchins through the side, about 13%

through the top and about 13% through the base of the test. The rest were entered through the peristomeal membrane. When feeding on the burrowing echinoid *Cassidulus cariboeorum*, *C. tuberosa* usually penetrates the relatively spine-free ventromedial region of the test, but this site-preference is lost when very small individuals are attacked (Gladfelter, 1978). Foster (1947) recorded a *C. tuberosa* penetrating the burrowing urchin *Clypeaster rosaceus* (L.) near the anal region, while Moore (1956) described a specimen of the large burrowing urchin, *Plagiobrissus grandis*, as having been penetrated through the anterolateral edge by *Cassis madagascariensis*. In the present study, *C. flammea* feeding on *T. ventricosus* and *E. lucunter* penetrated 6 urchins through the side, 3 through the top and 1 through the base of the test. *C. testiculus*, also feeding on *T. ventricosus* and *E. lucunter*, penetrated 15 urchins through the peristomeal membrane, 1 through the base of the test, 5 through the side and 7 through the top. Five *D. antillarum* were penetrated by *C. testiculus* through the periproct and 1 through the peristomeal membrane, but none was penetrated through the test. Because of its membranous periproct, *D. antillarum* is particularly vulnerable to attack in this region. Moore (1956) found 3 *P. granulatum* to have penetrated the clypeastroid *Mellita quinquesperforata* near the centre of the aboral surface. Beu et al. (1972) observed that New Zealand Tertiary Spatangoida presumed to have been eaten by cassids or cymatiids, were drilled mainly near the anterior end of the test, and remarked that a predator holding the prey in an anterior position would prevent the prey escaping and would be able to push inside the backwardly directed spines more easily.

The bias of *Cypraecassis testiculus* to penetrate *Tripneustes ventricosus* and *Echinometra lucunter* through the peristomeal membrane contrasts with the tendency of *Cassis tuberosa* and *C. flammea* to penetrate these urchins through the side of the test. In all cases, the proboscis can easily be extended to all inner parts of the prey and the position of entry would seem to be correlated either with the way the prey is gripped during feeding (*Cassis* spp. feeding on *T. ventricosus* and *E. lucunter*) or with the ease of penetration (*C. tuberosa* feeding on *Cassidulus cariboeorum*, *C. testiculus* feeding on *T. ventricosus*, *E. lucunter* and *Diadema antillarum*).

### Mechanics of penetration

Before cassids penetrate the prey test, an area slightly larger in diameter than that of the proboscis is cleared of spines that are swallowed by *Cassis* spp. but, except for very small ones, discarded by *Cypraecassis testiculus*. *Cassis tuberosa* and *Cypraecassis testiculus* complete this phase in 4–5 min. A circular groove is then cut in the test, again taking about 5 minutes. The disc of test thereby cut out is usually pushed inwards, but sometimes is displaced outside the test. Cutting is achieved by the combined action of sulfuric acid and radula. Scanning electron micrographs reveal severely etched surfaces but no signs of radular scrape marks (Fig. 2c–e). The median cusps of the central teeth, however, show considerable wear (Fig. 2h), and the buccal mass of *C. testiculus* was seen to be in perpetual rhythmic action during penetration. The radula is thus undoubtedly used in the drilling process and probably removes the calcium sulfate produced during etching, thereby exposing new layers of calcium carbonate to the sulfuric acid and maximizing the rate of erosion. Day (1969) found that etching was impeded by the precipitate of calcium sulfate formed when drops of sulfuric acid were placed on bivalve shells. The radula must also be instrumental in rasping through the peristomeal and periproct membranes that are more resistant to the action of sulfuric acid than the test.

The etched surface of the test is confined to within a few  $\mu\text{m}$  of the edge of the hole (Fig. 2c), suggesting that the 'lips' of the proboscis form a seal around the area penetrated, thereby preventing leakage and dilution of the sulfuric acid. Considerable amounts of sulfuric acid may continue to be secreted after penetration because the plates of the test become loosened and the test is easily crushed. The delicate tests of *Diadema antillarum* are often crushed by the weight of *Cypraecassis testiculus* during feeding. Collapse occurs merely because the tests have been weakened by erosion and not, as suggested by Schroeder (1962), because the predator has crushed them with its foot to render the inner parts more accessible.

### CONSUMPTION OF PREY

Having penetrated the test, *Cassis tuberosa*, *C. flammea* and *Cypraecassis testiculus*

consume all the internal tissue, leaving only the gut contents, the peristomeal membrane, and occasionally some of the ampullae. When the internal tissue has been eaten, *C. tuberosa* and *C. flammaea* often commence to eat the tube feet, pedicellariae and spines, the proportion eaten varying widely and depending on the appetite. The spines are voided intact in the feces, stacked in parallel in bundles and intermingled with thin black filaments up to 30 cm long. *C. testiculus* swallows only the very smallest spines but eats the tissue and muscles at the bases of the larger spines that become detached and drop to the substratum. The long mobile spines of *Diadema antillarum* have very large basal muscles and these must comprise a relatively high proportion of the diet when this species is eaten.

Surprisingly, we found no significant correlation between the time taken to penetrate and consume an urchin (handling time) and the size of the prey (Fig. 6). Much of the variation in handling time was due to the proportion of spines eaten. Hughes & Hughes (1971) found that of 295 *Tripneustes ventricosus* and

*Echinometra lucunter* eaten by *Cassia tuberosa*, about 30% had <9% spines eaten, 50% had 10–90% spines eaten, and 20% had 90–100% spines eaten. The mean handling time for *C. tuberosa* feeding on *T. ventricosus* and *E. lucunter* in the present study was 79 min, S.E. = 6.4 min,  $n = 38$ . The single *Cassia flammaea* always consumed all the spines and took an average of 5.5 hr to finish each meal, whereas *C. tuberosa* seldom took more than 2.5 hr, even when all spines were eaten. In spite of its small size, *Cypraecassis testiculus* consumed *T. ventricosus* and *E. lucunter* at the same rate as *C. tuberosa*, the mean handling time being 79 min, S.E. = 9 min,  $n = 25$ .

#### Dietary value of prey and size selection

In order to estimate the dietary value of the internal and external tissue of *Tripneustes ventricosus*, *Echinometra lucunter* and *Diadema antillarum*, we dried samples of intact urchins and those preyed upon by *Cassia* spp. and *Cypraecassis testiculus* to constant

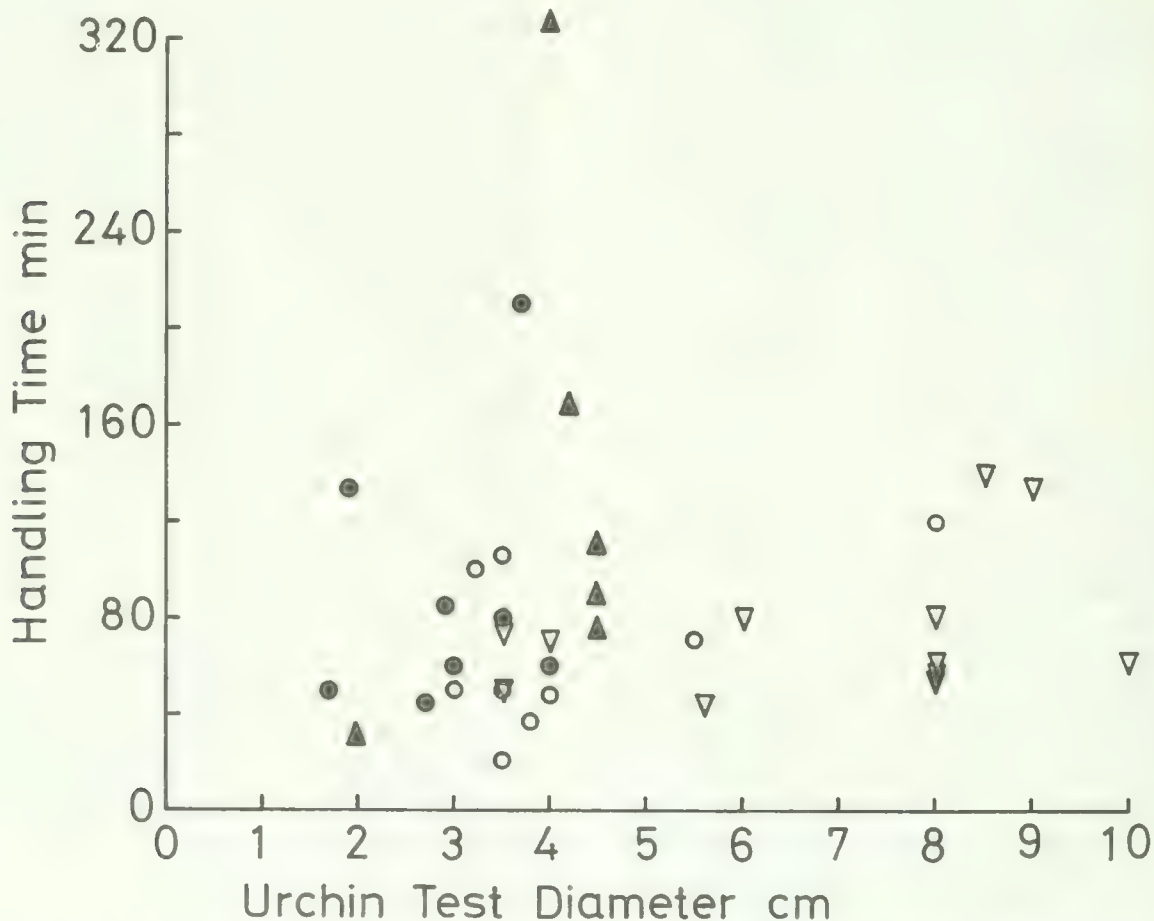

FIG. 6. Handling time (time taken to penetrate test and finish meal plotted against diameter (excluding spines) of prey;  $\nabla$  *Cassia tuberosa* feeding on *Tripneustes ventricosus*;  $\bullet$  *Cypraecassis testiculus* feeding on *Echinometra lucunter*;  $\circ$  *C. testiculus* feeding on *T. ventricosus*;  $\blacktriangle$  *C. testiculus* feeding on *Diadema antillarum*.

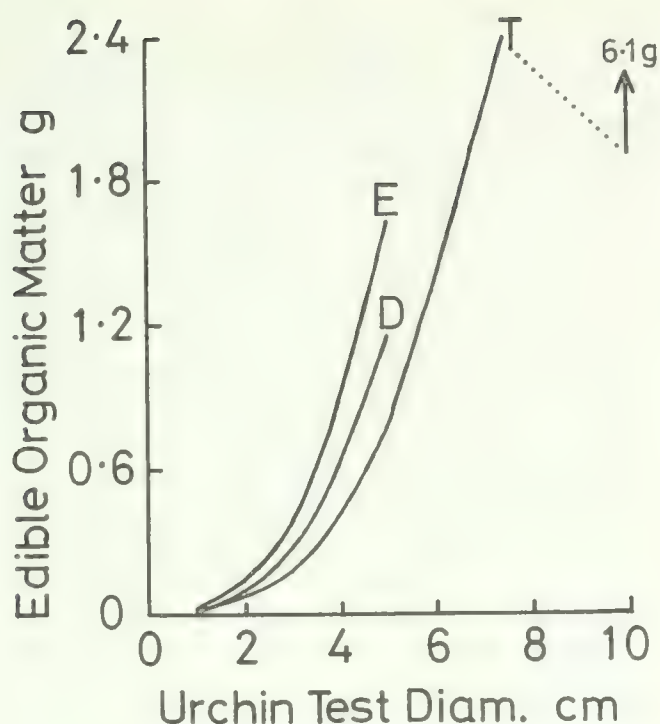

FIG. 7. Ash free dry weight of total edible organic matter as a function of diameter of prey. E *Echinometra lucunter*, D *Diadema antillarum*, T *Tripneustes ventricosus*. Regression equations for the data after  $\log_e$  transformation of both variables are: E  $y = 2.8x - 3.5$ , T  $y = 3.0x - 4.5$ , D  $y = 2.9x - 3.6$ . Intercept values for internal edible organic matter are E - 4.0, T - 5.0, D - 4.5.

weight at 60°C, heated them in a muffle furnace for 3 hr at 500°C and reweighed them. Only urchins that had either all or none of the spines eaten were chosen. We estimated that the external tissue accounted for about 31% of the total ash free dry weight of the meal when all spines were eaten. The total ash free dry weight of edible material (internal plus external) increased approximately as the cube of the diameter (i.e. volume) of the test (Fig. 7). The nutritional value of an urchin will, of course, differ greatly according to whether its gonads are fully ripe, as in our material, or spent.

Since the time taken to penetrate urchins is only a small proportion of the total handling time, the dietary value of urchins would seem to increase monotonically with size. We should expect, therefore, that larger urchins would be preferred to smaller ones, as long as they can be caught easily. There is no evidence, however, for the size selection of prey by cassids. The most substantial data are for *Cassis tuberosa* feeding on *Cassidulus cariboeorum* (Gladfelter, 1978). In this case, the size frequency of live urchins in the prey population was similar to that of tests cast up

on the shore after being drilled by *C. tuberosa*.

At least in shallow water, cassids are usually nocturnal predators that retreat into the sand at daybreak to avoid predation. During the hours of darkness there is time to eat only a few urchins and, if the encounter rate with prey is low or uncertain, it may pay to attack the first urchin encountered, irrespective of size. This is a 'time-minimizing' as opposed to an 'energy maximizing' feeding behaviour (Hughes, 1980). In support of this interpretation, we found that on completing a meal, *Cassis tuberosa* and *Cypraecassis testiculus* would usually retreat into the sand until the following evening. Size selection of prey, suggesting an energy maximizing feeding behaviour has, however, been recorded in *Cymatium nicobaricum*, which prefers larger to smaller gastropods (Houbrick & Fretter, 1969). It is perhaps significant that this predator will continue feeding during the day, albeit less frequently, than at night.

## DISCUSSION

The ability to drill through the calcareous plates and shells of echinoderms and mollusks has evolved independently in the Tonnacea, Naticidae and Muricidae. In the Naticidae and Muricidae drilling is achieved by alternating application of the accessory boring organ (ABO) and the radula to the excavation. The ABO, located in the propodium, secretes a mucoid, slightly acidic, hypertonic fluid rich in hydrogen, chloride and sodium ions. The ABO secretion also contains carbonic anhydrase and probably other enzymes and chelating agents (Carriker & Williams, 1978). Etching of the prey shell begins by the preferential dissolution of the organic matrix, probably by proteolytic enzymes, which has the effect of increasing the surface area of mineral crystals exposed to solubilization and facilitating the removal of shell material by the radula (Carriker, 1978). Minerals are dissolved by the hydrochloric acid and probably also by a chelating agent and the action of carbonic anhydrase. Calcium ions freed from the shell in the borehole enter the microvilli of the ABO and pass into the foot of the snail, the transmembrane flux of calcium probably being aided by carbonic anhydrase and adenosine triphosphate (Carriker & Williams, 1978).

The chemical etching process of the tonnacian proboscis gland (PG) secretion

resembles that of the naticid and muricid ABO secretion in that mineral dissolution involves an inorganic acid and probably a chelating agent (Day, 1969). PG secretion, however, is produced in much larger quantities than ABO secretion (large *Galeodea echinophora* can eject up to 1 ml of secretion when irritated [Fänge & Lidman, 1976], compared with the few  $\mu\text{l}$  secreted by the ABO of *Urosalpinx cinerea follyensis* Baker during excavation [Carriker et al., 1978]) and is more acidic (pH 0.13 in *G. echinophora* [Fänge & Lidman, 1976], pH 1.1 in *Argobuccinum argus* [Day, 1969], compared with ABO secretion of pH 3.8–4.0 when in contact with seawater in *U. cinerea* [Carriker et al., 1978]). PG secretion differs further from ABO secretion in having a high concentration of sulfate and a relatively low concentration of chloride ions, a much lower concentration of organic matter and an apparent lack of enzymes (Fänge & Lidman, 1976; Day, 1969). The in vitro calcium carbonate solubilizing properties of *A. argus* PG secretion are unimpaired by boiling the secretion (Day, 1969), whereas ABO secretion of *U. cinerea* loses its etching properties after heating to 80°C (Carriker & Williams, 1978).

Cassids penetrate echinoid test at a speed of about 0.1 mm per minute in contrast to the muricid *Urosalpinx cinerea* that penetrates oyster shell at a speed of about 0.3–0.5 mm per day (Carriker & Williams, 1978). Most of this difference in drilling speed is probably attributable to the porous structure of echinoid test (Fig. 2c–e) compared with the denser material of bivalve shell. This comparison, however, is complicated by the fact that cassids cut out a disc, whereas naticids and muricids bore a hole. The drilling speed of tonnageans, if they could be induced to penetrate bivalve shells, would be of great interest. Day (1969) found that PG secretion of *Argobuccinum argus* had produced a shallow depression 2–3 hr after being placed on the valve of *Macoma* sp., but of course the calcium sulfate accumulating over the etched surface would have progressively retarded erosion. Day (1969) concluded that the mineral fraction was dissolved faster than the organic fraction of the shell because remnants of the organic matrix at the edges of the eroded area were visible under the microscope. If this interpretation is correct, the action of tonnagean PG secretion would contrast with that of naticid and muricid ABO secretion, which attacks the organic matrix prior to the dissolution of minerals.

The drilling of molluscan shells by tonnageans has never been recorded with certainty. Molluscivorous cymatiids penetrate their prey through the shell apertures. *Cymatium nicobaricum* inserts its proboscis into the mantle cavity of its gastropod prey (Houbriek & Fretter, 1969) and *Monoplex australasiae* Perry pushes its proboscis down through the substratum and in between the valves of its bivalve prey (Laxton, 1971). Sulfuric acid, although adequate for corroding the porous plates and spicules of echinoderms, may not be as effective as ABO secretion of naticids and muricids for etching the more solid material of molluscan shells.

It is debatable whether the secretion of sulfuric acid by tonnageans evolved first as a defensive or as an offensive device. Sulfuric acid would seem, a priori, not to be a particularly effective agent for attacking prey lacking calcareous armory, yet well developed sulfuric acid-secreting proboscis glands are possessed by all tonnageans, even though many of them in the Cymatiidae and Bursidae feed on soft bodied prey such as polychaetes, sipunculans, ascidians and sponges (Houbriek & Fretter, 1969; Laxton, 1971; Taylor, 1978). Sulfuric acid may, however, be effective in overcoming soft-bodied prey. When feeding on the sabellariid polychaete, *Gunnarea capensis* (Schmarda), *Argobuccinum argus* inserts its proboscis into the worm's tube and ejects a secretion into the crown of flattened setae that protect the head of the prey. The setae become loosened and can be dislodged by the predator's radula. Further experiments are needed, of course, to determine whether enzymes are secreted in addition to the sulfuric acid.

Echinoderms predominate in the diets of tonnageans; the Cassidae specialize on echinoids; the Tonnidae probably feed largely on holothurians (Bakus, 1973; Grange, 1974; Taylor et al., 1980), although Weber (1927) claimed that *Tonna galea* accepted echinoids; the Ficidae feed "on sea urchins and other echinoderms" (Abbott, 1968b), but actual data on ficid diets are lacking in the literature; the Bursidae feed on ophiuroids, echinoids and crinoids in addition to non-echinoderm taxa (Taylor, 1978), and members of the genus *Charonia* within the Cymatiidae feed on echinoids, asteroids and holothurians (Kisch, 1952; McPherson, 1968; Work, 1969; Laxton, 1971; Percharde, 1972; Endean, 1973; Thomassin, 1976). Cymatiid phylogeny is not sufficiently well known for firm conclu-

sions to be drawn on the origin of echinoderm diets. Phylogenetically more 'primitive' recent cymatiids, however, feed on a variety of phyla and it is possible that a specialized diet on echinoderms is not a primitive characteristic. The phylogenetic relationship between the Cassidae and Cymatiidae is obscure, precluding meaningful speculation on the evolution of the cassid feeding method (Taylor, personal communication). Sohl (1969) published a photograph of the fossil burrowing echinoid *Hamea alta* (Arnolde & Clarke) with a hole in the test that was clearly made by a cassid, and this late Eocene fossil appears to be the earliest known record of cassid feeding activities.

#### ACKNOWLEDGEMENTS

We thank Finn Sander for providing facilities at the Bellairs Research Institute of McGill University, Barbados. Special thanks go to George Godson, whose unstinted help and knowledge of the habitats of *Cassis tuberosa* saved us from the brink of disaster due to the lack of animals, to Tom Tomasik for collecting for us the splendid specimen of *Cassis flammæa*, and to Norman Runham and Andrew Davis for their skillful use of the scanning electron microscope. Constance Boone, Gene Everson and Porter Kier kindly supplied their unpublished data on cassid diets. Our warm thanks are extended to Melbourne Carriker and Robert Robertson for constructively reviewing our manuscript. Financial support enabling us to deliver the paper at the AMU symposium, 1980, was provided by the Royal Society and the American Malacological Union. Finally, we thank Alan Kohn for inciting us to take another look at cassids.

#### REFERENCES CITED

- ABBOTT, R. T., 1968a, Helmet shells of the world (Cassidae): 1. *Indo-Pacific Mollusca*, 2: 7–201.
- ABBOTT, R. T., 1968b, *Seashells of North America. A guide to field identification*. Golden Press, New York, 280 p.
- ASANO, M. & ITOH, M., 1960, Salivary poison of a marine gastropod, *Neptunea arthritica* Bernardi, and the seasonal variation in its toxicity. *Annals of the New York Academy of Science*, 90: 674–688.
- BAKUS, G. J., 1973, The biology and ecology of tropical holothurians. In: JONES, O. A. & ENDEAN, R. (eds.), *Biology and geology of coral reefs*, 2 Biology 1: 325–367. Academic Press, London.
- BEU, A. G., HENDERSON, R. A. & NELSON, C. S., 1972, Notes on the taphonomy and paleoecology of New Zealand Tertiary Spatangoida. *New Zealand Journal of Geology and Geophysics*, 15: 275–286.
- CARRIKER, M. R., 1978, Ultrastructural analysis of dissolution of shell of the bivalve *Mytilus edulis* by the accessory boring organ of the gastropod *Urosalpinx cinerea*. *Marine Biology*, 48: 105–134.
- CARRIKER, M. R. & WILLIAMS, L. G., 1978, The chemical mechanism of shell dissolution by predatory boring gastropods: a review and an hypothesis. *Malacologia*, 17: 143–156.
- CARRIKER, M. R., WILLIAMS, L. G. & VAN ZANDT, D., 1978, Preliminary characterisation of the secretion of the accessory boring organ of the shell-penetrating muricid gastropod *Urosalpinx cinerea*. *Malacologia*, 17: 125–142.
- CHESHER, R. H., 1969, Contributions to the biology of *Meoma ventricosa* (Echinoidea: Spatangoida). *Bulletin of Marine Science*, 19: 72–110.
- CORNMAN, I., 1963, Toxic properties of the saliva of *Cassis*. *Nature*, 200: 88–89.
- DAY, J. H., 1969, Feeding of the cymatiid gastropod, *Argobuccinum argus*, in relation to the structure of the proboscis and secretions of the proboscis gland. *American Zoologist*, 9: 909–916.
- DAY, J. H., 1974, *A guide to marine life on South African shores*, Balkema, Cape Town and Rotterdam, iii + 300 p.
- EDMUNDS, J. & EDMUNDS, M., 1973, Preliminary report on the Mollusca of the benthic communities off Tema, Ghana. *Proceedings of the Fourth European Malacological Congress; Malacologia*, 14: 371–376.
- ENDEAN, R., 1969, *Report on investigations made into aspects of the current Acanthaster planci (crown of thorns) infestation of certain reefs of the Great Barrier Reef*. Fisheries Branch, Queensland Department of Primary Industries, Brisbane.
- ENDEAN, R., 1972, Aspects of molluscan pharmacology. In: FLORKIN, M. & SCHEER, B. T., (eds.) *Chemical Zoology*, 7: Mollusca, p. 421–466. Academic Press, New York, London.
- ENDEAN, R., 1973, Population explosions of *Acanthaster planci* and associated destruction of hermatypic corals in the Indo-West Pacific region. In: JONES, O. A. & ENDEAN, R. (eds.), *Biology and geology of coral reefs*, 2: Biology 1: 389–438. Academic Press, London.
- FÄNGE, R. & LIDMAN, U., 1976, Secretion of sulfuric acid in *Cassidaria echinophora* Lamarck (Mollusca: Mesogastropoda, marine carnivorous snail). *Comparative Biochemistry and Physiology*, 53A: 101–103.
- FOSTER, R. W., 1947, *Cassis tuberosa* L. feeding on an echinoid (*Clypeaster rosaceus* L.). *Nautilus*, 61: 35–36.
- GLADFELTER, W. B., 1978, General ecology of the cassiculoid urchin *Cassidulus caribbearum* [sic]. *Marine Biology*, 47: 149–160.

- GRANGE, K. R., 1974, The feeding of *Tonna ceverisina*. *Poiriera*, 7: 57-61.
- HENDLER, G., 1977, The differential effects of seasonal stress and predation on the stability of reef-flat echinoid populations. *Proceedings Third International Coral Reef Symposium*, 1 Biology: 217-223.
- HOUBRICK, J. R. & FRETTER, V., 1969, Some aspects of the functional anatomy and biology of *Cymatium* and *Bursa*. *Proceedings of the Malacological Society of London*, 38: 415-429.
- HUGHES, R. N., 1980, Optimal foraging theory in the marine context. *Oceanography and Marine Biology: an Annual Review*, 18: 423-481.
- HUGHES, R. N. & HUGHES, H. P. I., 1971, A study of the gastropod *Cassidula tuberosa* (L.) preying upon sea urchins. *Journal of experimental marine Biology and Ecology*, 7: 215-315.
- KISCH, B. S., 1952, Further note on *Charonia lampas* (L.). *Journal of Conchology*, 23: 266.
- LAXTON, J. H., 1971, Feeding in some Australasian Cymatiidae (Gastropoda: Prosobranchia). *Zoological Journal of the Linnean Society*, 50: 1-9.
- LYMAN, F. B., 1937, Food of *Cassidula madagascariensis*. *Nautilus*, 51: 34.
- MCPHERSON, B. F., 1968, Contributions to the biology of *Eucidaris tribuloides* (Lamarck). *Bulletin of Marine Science*, 18: 400-443.
- MOORE, D. R., 1956, Observations of predation on echinoderms by three species of Cassidae. *Nautilus*, 69: 73-76.
- NÜSKE, H., 1973, Cytologische Untersuchungen an der Sauredrüse der Meeresschnecke *Cassidaria echinophora*. *Cytobiologie*, 7: 164-180.
- PANCERI, P., 1869, Gli organi e la secrezione dell'acido solforico nei gasteropodi. *Atti dell'Accademia delle scienze fisiche e matematiche, Napoli*, 4: 1-56.
- PERCHARDE, P. L., 1972, Observations on the gastropod *Charonia variegata* in Trinidad and Tobago. *Nautilus*, 85: 84-92.
- PROFANT, R. J., 1970, Reef wreckers. *Tabulata*, January 1, 1970: 3-5. (Santa Barbara Malacological Society, Santa Barbara).
- REYNELL, A., 1905, Some account of the anatomy of *Cassidaria rugosa* (Linn.). *Proceedings of the Malacological Society of London*, 6: 292-299.
- SCHROEDER, R. E., 1962, Urchin killer. *Sea Frontiers*, 8: 156-160.
- SNYDER, N. & SNYDER, H., 1970, Alarm response of *Diadema antillarum*. *Science*, 168: 276-278.
- SOHL, N. F., 1969, The fossil record of shell boring by snails. *American Zoologist*, 9: 725-734.
- TAYLOR, J. D., 1978, Habitats and diet of predatory gastropods at Addu Atoll, Maldives. *Journal of experimental marine Biology and Ecology*, 31: 83-103.
- TAYLOR, J. D., MORRIS, N. J. & TAYLOR, C. N., 1980, Food specialization and the evolution of predatory prosobranch gastropods. *Palaeontology*, 23: 375-409.
- THOMASSIN, B. A., 1976, Feeding behaviour of the felt-, sponge-, and coral-feeder sea stars, mainly *Culcita schmideliana*. *Helgoländer wissenschaftliche Meeresuntersuchungen*, 28: 51-65.
- WEBER, H., 1927, Der Darm von *Dolium galea* L., eine vergleichende anatomische Untersuchung unter besonderer Berücksichtigung der *Tritonium*-arten. *Zeitschrift für wissenschaftliche Biologie, Abt. A, Zeitschrift für Morphologie und Ökologie der Tiere*, 8: 663-804.
- WORK, R. C., 1969, Systematics, ecology and distribution of the mollusks of Los Roques, Venezuela. *Bulletin of Marine Science*, 19: 614-711.
- YANINEK, J. S., 1978, A comparative survey of reef-associated gastropods at Maziwi Island, Tanzania. *Journal of the East African Natural History Society and National Museum*, 31: 1-16.



## SHELL PENETRATION AND FEEDING BY NATICACEAN AND MURICACEAN PREDATORY GASTROPODS: A SYNTHESIS

Melbourne R. Carriker

*College of Marine Studies, University of Delaware, Lewes, Delaware 19958, U.S.A.*

### ABSTRACT

Predatory gastropod shell borers occur among the Capulidae, Naticaceae, Tonnacea, Muricacea, and Vayssiéridae. With the exception of boring nudibranchs, all known gastropod borers are shelled. This synthesis is concerned primarily with naticacean and muricacean borers that excavate smooth, round, beveled holes. They occur in every coastal region of the world that has been examined, and identify prey chemoreceptively. The shell penetrating mechanism includes at least an accessory boring organ (ABO) and radula. The ABO is located in three separate anatomical regions in different groups of borers: in muricaceans, in the sole of the foot anterior to the ventral pedal gland or atop the ventral pedal gland; in naticaceans, under the tip of the proboscis. Studies of the ABO of several species of naticacean and muricacean snails reveal a common ultrastructural form. An acid (possibly HCl) and unidentified chelating agents and enzymes in a hypertonic mucoid secretion released by the ABO are hypothesized to dissolve shell during hole boring. All 33 species of naticacean and muricacean snails examined possess an ABO and are shell borers; the ABO does not appear to have evolved in other shell penetrating molluscs. The role of tubular salivary glands (missing in some muricids and naticids), hypobranchial glands, and anterior pedal mucous glands in shell penetration is uncertain. Borers release paralytic substances from the hypobranchial gland, and possibly also from other glands associated with the proboscis. Gastropods known to bore holes in prey shell date from the Jurassic and perhaps the late Triassic, some two hundred million years ago. Progress is being made in the control of commercially important species of muricaceans, but not of naticaceans.

### INTRODUCTION

A notable characteristic of many molluscs is their capacity to secrete a protective calcareous exoskeleton. Another is ironically the ability of some of these same molluscs to bore or burrow into the shells of other invertebrates. A voluminous literature has described the structure and development of molluscan shell (Grégoire, 1972; Wilbur, 1972; Watabe & Wilbur, 1976), but much less is known about processes of shell breakdown by invertebrates and lower plants (Carriker, Smith & Wilce, 1969). Molluscan calcibiocavities (Carriker & Smith, 1969) have been reported in three classes: the Bivalvia (burrowers), Gastropoda (borers), and Cephalopoda (borers). Among the Gastropoda, shell penetrating snails occur in the mesogastropod family Capulidae, mesogastropod superfamilies Naticacea and Tonnacea, neogastropod superfamily Muricacea, and the nudibranch family Vayssiéridae (Carriker, Smith & Wilce, 1969). With the exception of boring nudibranchs, all known shell penetrating gastropods possess a shell.

This review is concerned primarily with the biology of shell penetration and feeding by predatory gastropods in the superfamilies Naticacea and Muricacea.

### DISTRIBUTION AND TYPES OF BORING MECHANISMS

Every coastal region of the world that has been examined supports populations of boring gastropods (see representative examples in Table 1). Most species are subtropical or tropical, the number increasing toward the equator (Taylor et al., 1980). It is likely that further zoogeographical investigations will locate them off the shores of most land masses (Sohl, 1969). As suggested by the presence of bore holes in prey shells, boring snails range in depth from intertidal zones to at least 2,700 m (Carriker, 1961), and their numbers decrease into deeper water (Taylor et al., 1980). Clarke (1962) lists several species of Naticidae and Muricidae that occur in abyssal regions of the oceans, but it is not known whether they are borers, or whether

TABLE 1. Species, source of specimens, and comparative anatomy of accessory boring organ (ABO), ventral pedal gland (VPG), and tubular salivary glands of muricacean and naticacean boring gastropods. S, ABO in anterior midventral sole of foot; aVPG, anterior to ventral pedal gland; p, ABO on anterior ventral tip of proboscis; relative size of tubular salivary glands: 0, absent; 1–5, small to large. Nomenclature of North American species based on Abbott (1974).

Species	Source	Accessory boring organ, location		Ventral pedal gland	Size tubular salivary gland
		Male	Female		
Muricacea:					
<i>Bedevea hanleyi</i>	Port Jackson, Australia	S	aVPG	Reduced	1
<i>Eupleura caudata</i>	North Carolina to Massachusetts, U.S.A.	S	aVPG	Large	3
<i>E. caudata etterae</i>	Virginia, U.S.A.	S	aVPG	Large	4
<i>E. sulcidentata</i>	Florida, U.S.A.	S	aVPG	Large	4
<i>Murex brevifrons</i>	Puerto Rico	S	aVPG	Reduced	3
<i>M. cellulosus</i>	Florida, U.S.A.	S	aVPG	Absent	3
<i>M. florifer</i>	Florida, U.S.A.	S	aVPG	Large	2
<i>M. fulvescens</i>	North Carolina, U.S.A.	S	aVPG	Reduced	1
<i>M. pomum</i>	Florida, U.S.A.	S	aVPG	Absent	0
<i>Muricopsis ostrearum</i>	Florida, U.S.A.	S	aVPG	Absent	4
<i>Nucella emarginata</i>	Washington, U.S.A.	S	aVPG	Large	5
<i>N. lamellosa</i>	Washington, U.S.A.	S	aVPG	Large	5
<i>N. lapillus</i>	England; Massachusetts, U.S.A.	S	aVPG	Large	4
<i>Ocenebra erinacea</i>	England	S	aVPG	Large	5
<i>O. inornata (= japonica)</i>	Japan; Washington, U.S.A.	S	aVPG	Large	4
<i>Pterorytis foliata</i>	Washington, U.S.A.	S	aVPG	Large	3
<i>Purpura clavigera</i>	Japan	S	atop VPG	Large	4
<i>Rapana thomasi</i>	Japan	S	atop VPG	Large	5
<i>Thais haemastoma</i>	Bimini, Bahamas	S	atop VPG	Large	5
<i>T. haemastoma floridana</i>	North Carolina, U.S.A.	S	atop VPG	Large	5
<i>T. haemastoma canaliculata</i>	West coast Florida, U.S.A.	S	atop VPG	Large	5
<i>T. deltoidea</i>	Bimini, Bahamas	S	aVPG	Absent	5
<i>Urosalpinx cinerea</i>	England; Florida to Massachusetts, U.S.A.	S	aVPG	Large	4
<i>U. cinerea follyensis</i>	Virginia, U.S.A.	S	aVPG	Large	4
<i>U. perrugata</i>	Florida, U.S.A.	S	aVPG	Large	3
<i>U. tampaensis</i>	Florida, U.S.A.	S	aVPG	Large	3
Naticacea:					
<i>Lunatia heros</i>	Massachusetts, U.S.A.	p	p	Absent	0
<i>L. lewisi</i>	Washington, U.S.A.	p	p	Absent	0
<i>L. triseriata</i>	Massachusetts, U.S.A.	p	p	Absent	0
<i>Natica severa</i>	Korea	p	p	Absent	0
<i>Neverita didyma</i>	Korea	p	p	Absent	0
<i>Polinices duplicatus</i>	Florida, North Carolina, Massachusetts, U.S.A.	p	p	Absent	0
<i>Sinum perspectivum</i>	Florida, North Carolina, U.S.A.	p	p	Absent	0

members of other families are also shell penetrants. A study of gastropod boreholes from the deep sea could clarify some of these questions.

Naticacean and muricacean boreholes typically possess smooth walls, beveled outer edges, decreasing diameters with depth, and are generally circular and perpendicular to the shell surface. The typical naticid borehole is a

truncated spherical paraboloid; muricid holes, on the other hand, although also variously countersunk, are considerably more varied in vertical section than naticid holes (Carriker & Yochelson, 1968). Nudibranchs (*Okadaia elegans*; Young, 1969) also excavate smooth, round, beveled holes, while capulids (*Capulus danieli*; Orr, 1962), and cephalopods (*Octopus vulgaris*; Arnold & Arnold,

1969; Nixon, 1979) excavate asymmetric, sometimes jagged boreholes. Identification of shell-penetrating molluscs on the basis of their boreholes is thus difficult, except possibly for naticids.

Although the anatomy of the shell-penetrating mechanism differs among different species, all 33 naticacean and muricacean species and subspecies that I have examined possess an accessory boring organ (ABO) and excavate boreholes in the shell of their prey (Table 1) (Carriker, 1961). In all muricacean males the ABO is located in the mid-anterior ventral part of the foot (Fig. 1). In most muricacean females the organ occurs in the mid-anterior ventral part of the foot but anterior to the ventral pedal gland (the egg capsule gland of some authors) (Fig. 2) when the gland is present. In a small number of muricacean females the ABO lies atop, and is continuous with, the ventral pedal gland, so that during its eversion the ABO passes through the cavity of the gland (Fig. 3). In all naticaceans examined, the ABO is located on the anterior ventral lip of the proboscis (Fig. 4).

In seven of the muricacean species examined, the ventral pedal gland was absent, or present only as a shallow depression, at the time of dissection, but the ABO was fully formed (Table 1). In these species the ventral pedal gland develops and is functional at the time of oviposition.

Fretter & Graham (1962) reviewed hole-boring by the muricids *Nucella lapillus*, *Ocenebra erinacea*, and *Urosalpinx cinerea*, and by the naticids *Natica nitida* and *N. catena*. Radwin & Wells (1968) observed boring in the laboratory by *Murex pomum*, *M. fulvescens*, *M. florifer*, *M. cellulosus*, *Muricopsis ostrearum*, *Urosalpinx perrugata*, and *U. tampaensis*, and Hemingway (1973, 1975a, b) discussed boring by the muricid *Acanthina spirata*. Observations on boring by these species corroborate those for similar species listed in Table 1.

Tubular salivary glands (accessory salivary glands of some authors) occur in most Muricacea (Fretter & Graham, 1962). All the muricaceans listed in Table 1 possess obvious tubular salivary glands except *Murex pomum* in which none was found. The size of the glands relative to the height of each snail varies markedly, being rather small in *Bedeva hanleyi*, *Murex florifer arenarius*, and *M. fulvescens*, and largest in the genera *Rapana* and *Thais*. No tubular salivary glands were

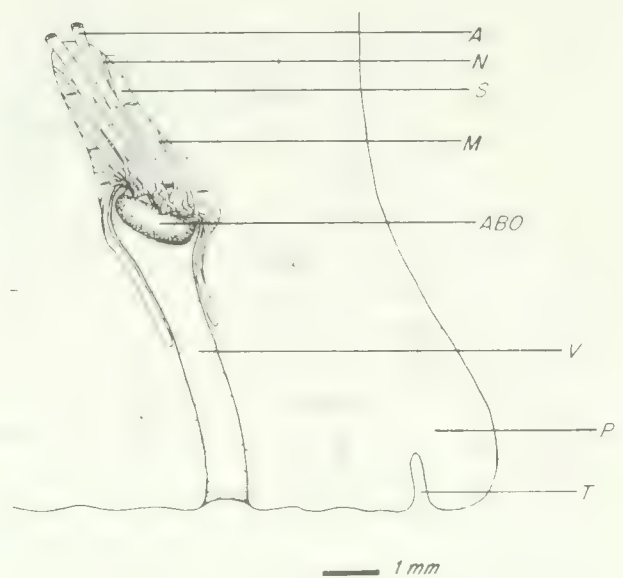

FIG. 1. Drawing of sagittal section of anterior part of foot of a male muricacean, *Rapana thomasiiana*, through the accessory boring organ, ABO. S, ABO sinus containing arteries (A), nerves (N), and muscles (M) passing to back of ABO. V, ABO vestibule through which ABO is extended to borehole. P, propodium, T, transverse furrow.

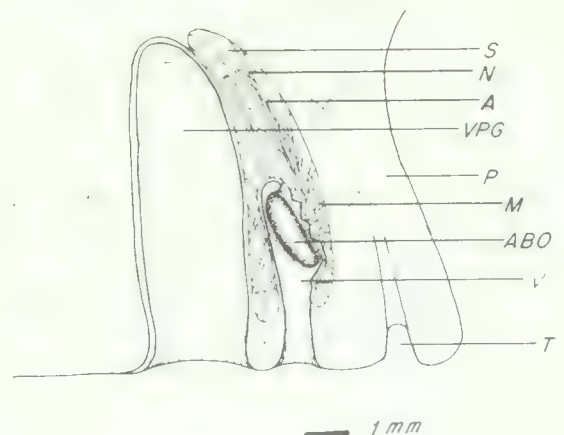

FIG. 2. Drawing of sagittal section of anterior part of foot of a female muricacean, *Urosalpinx cinerea follyensis*, through the accessory boring organ, ABO, and ventral pedal gland, VPG. S, ABO sinus. V, ABO vestibule. P, propodium, T, transverse furrow. N, nerve. A, artery, M, muscle.

found in species of Naticacea. Hemingway (1973, 1975a, b) reported that the tubular salivary glands of *Acanthina spirata* are similar to those of *Urosalpinx cinerea*. The variable size of tubular salivary glands in most muricaceans, and their absence in naticaceans and one species of Muricidae, cast



FIG. 3. Drawing of sagittal section of anterior part of foot of a female muricacean, *Rapana thomasiana*, through the accessory boring organ, ABO, and ventral pedal gland, VPG. The ABO is located atop the ventral pedal gland and in eversion passes through the lumen of the gland. S, ABO sinus, N, nerve. A, artery. M, muscle, V, ABO vestibule. P, propodium. T, transverse furrow.

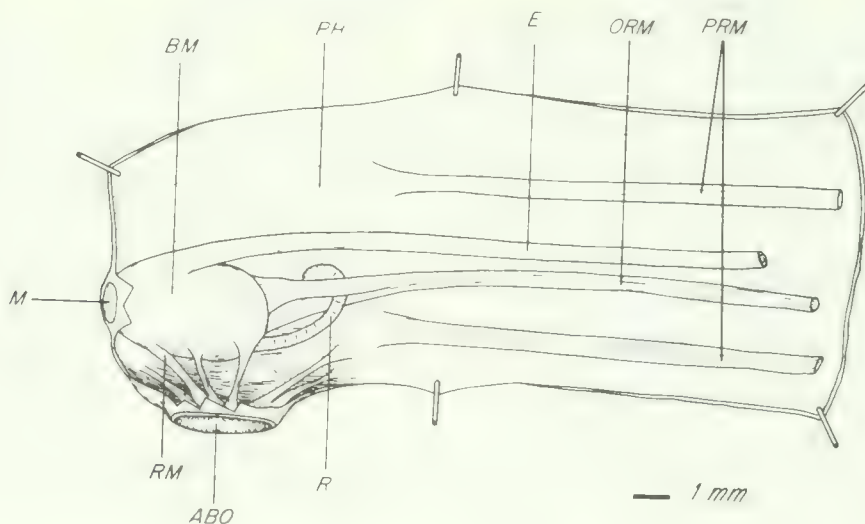

FIG. 4. Drawing of left side of proboscis of a naticacean, *Polinices duplicatus*, opened laterally to illustrate relationship of accessory boring organ, ABO, to buccal mass, BM, and to proboscoidal hemocoel, PH. RM, retractor muscle. M, mouth. R, radular sac. E, esophagus. ORM, odontophoral retractor muscle. PRM, proboscoidal retractor muscle.

doubt on the direct functional role of these glands in the shell boring process.

The curious position of the ABO on top of the ventral pedal gland in species of *Purpura*, *Rapana*, and *Thais* suggests a close affinity of these taxa. Likewise, the absence of this anatomical arrangement in *Nucella lapillus* supports the contention that the species *N. lapillus* does not belong in the genus *Thais* (Abbott, 1974).

#### RESPONSE TO PREY

Muricaceans feed on a wide variety of bivalves, barnacles, gastropods, small crabs, encrusting bryozoans, and carrion of fish (though they generally select live over dead prey), and may on occasion become cannibalistic (Carriker, 1955; Hanks, 1957; Chew & Eisler, 1958; Fretter & Graham, 1962; Largent, 1967; Radwin & Wells, 1968;

Morgan, 1972; Menge, 1974; Pratt, 1974a; Bayne & Scullard, 1978; Barnett, 1979). Naticaceans, on the other hand, are more restricted in their diet and feed primarily on live bivalves (Hanks, 1952, 1953, 1960; Fretter & Graham, 1962; Franz, 1977; Edwards & Huebner, 1977; Wiltse, 1980). Prey utilization curves of a number of species of small boring gastropods are skewed toward large prey size, and those of large predators are skewed toward small prey size (Sassaman, 1974; but see also Taylor et al., 1980). Boring gastropods feed on the flesh of prey through boreholes excavated by them in the shell of prey, through unbored slits between valves when these are present (as in some bivalves and barnacles), or on gaping prey recently killed by other predators. A curious exception to this is the "commensal" muricid *Genkaimurex varicosa* that bores a hole in the shells of scallops and is thought to "suck juices" from them (Matsukuma, 1977).

Response of boring gastropods to prey has been studied primarily in muricids. Under experimental conditions in the laboratory and in the field, these snails can identify preferred live prey some distance away (Carriker, 1955; Wood, 1968; Carriker & Van Zandt, 1972a; Morgan, 1972; Pratt, 1974a). However, all individuals in a population may not respond at the same time. In the laboratory, for example, only 50 to 80% of a population of *Urosalpinx cinerea* will respond to recently introduced live prey (Carriker, 1957). Nor is preference for prey genetically fixed; existence of prey and predator in similar intertidal zones and relative abundance of prey account for prey selection (Wood, 1968; Pratt, 1974a). *U. cinerea* can be ingestively conditioned in the laboratory, tending to prefer effluents from a given prey species after it has ingested living tissues of that species (Wood, 1968). Starved *U. cinerea* are repelled by effluent from starved oyster drills and attracted to the effluent of satiated oyster drills. These responses probably increase foraging efficiency by directing snails away from unproductive areas and toward their prey (Pratt, 1974a, 1976).

Not all potential prey are attacked by muricids. When, for example, *Urosalpinx cinerea* is confined with a variety of species of bivalves, all are bored except *Anomia simplex* (Pratt, 1974a; Carriker, Van Zandt & Grant, 1978). Since these snails can bore through empty valves of *A. simplex* in laboratory experiments (Carriker, Van Zandt &

Grant, 1978), it is likely that they are suppressed by a chemical associated with living *A. simplex*.

Young boring gastropods, recently emerged from egg capsules (*Urosalpinx cinerea*; Carriker, 1957) and egg collars (*Natica gualtieriana*; Berg, 1976; *Polinices duplicatus*; Wiltse, 1980), also are attracted to young prey, bore holes in them and feed on the soft tissues. To what extent and how soon after initiation of feeding young snails become ingestively conditioned is uncertain. The matter requires investigation.

Most prey are incapable of defending themselves against boring gastropods. A striking exception to this is *Crepidula fornicata* that frequently jabs at an approaching borer with the radula, or dislodges the predator from its valve by pressing the predator against an obstacle (Pratt, 1974b). Apparently passive "retribution" on the part of prey occurs occasionally. There is a report of an oyster that apparently closed its valves on the proboscis of an *Eupleura caudata* that was inserted through a hole bored in the margin of the shell, and held the snail until it died. Shell material was then deposited around the predator's shell, permanently affixing it to the oyster's right valve (Burrell, 1975)! Another example is that of *Urosalpinx cinerea* which in the laboratory can be immobilized by byssi of *Mytilus edulis* at temperatures at which bivalves are active but snails have gone into hibernation. This probably does not occur to any extent in the field, as snails move toward the bottom away from mussels as the temperature of the seawater drops approximately below 15°C (personal observations).

Boring gastropods possess (a) chemoreceptive mechanism(s) for detecting prey and approaching them from a distance. Snails respond to chemical substances characteristic of the effluents of prey species they have eaten (Wood, 1968; Carriker & Van Zandt, 1972b; Morgan, 1972; Pratt, 1974a). Although attractiveness of prey is often marked and responded to by a large proportion of a predator population, the chemical stimulus that guides predators to prey has been identified only as one or more of the metabolic products of prey (Carriker & Van Zandt, 1972b).

Experimentation on carnivorous mesogastropods and neogastropods (Kohn, 1961; Crisp, 1973; Newell & Brown, 1977) suggests that the osphradium plays a primary role in distance chemoreception. The function of the

mantle edge, tentacles, and propodium in sensing chemical cues is probably also important and needs further investigation.

Primary recognition of the immediate presence of prey by muricaceans appears to depend on identification of a chemical cue in the exhalant water of prey. Snails creep over the bottom toward their prey, locating them most rapidly when the prey are on the upstream side of tidal currents (Carriker, 1955). Whether snails respond to the same chemicals from prey at a distance and close to prey, is unclear. When approaching actively pumping prey, *Urosalpinx cinerea*, for example, often raises the anterior part of the foot, stands on the posterior tip of the foot, propodium and tentacles fully extended, and swings the propodium back and forth in a pattern suggestive of searching. Whether distance or close-range attractant(s), or both, in exhalant seawater is reinforced by a further stimulus associated with the prey is uncertain. Reinforcement might come from valvular movements of the prey, chemical attractant adsorbed to the shell, topography of the prey shell, chemicals in the organic matrix of shell, or even unknown cues from the animal within the shell (Carriker & Van Zandt, 1972b). Pratt (1974a) reported that epibiota on the shell of prey did not play an important role in oyster drills' attacks on *Crepidula fornicata*. In laboratory experiments, Carriker & Van Zandt (1972b) noted that something on the surface of oyster valves, possibly microorganisms, enriched by effluent from pumping oysters, attracted snails to the oysters, but did not stimulate them to bore the shell. The problem needs clarification.

Very little information is available on the behavior of prey recognition by naticaceans (Kohn, 1961; Fretter & Graham, 1962; Carriker & Yochelson, 1968). The burrowing habit of these snails makes them difficult subjects for this kind of research.

The ability of boring gastropods to detect prey is influenced by environmental factors. For example, response to prey by *Urosalpinx cinerea* declines as temperature of the seawater drops in the fall from 15 to 7°C, depending on the latitude and other environmental factors (Carriker, 1954; Carriker & Van Zandt, 1972a). A salinity of 12.5 ‰ is near the lower limit for location of prey by both *U. cinerea* and *Eupleura caudata* (Manzi, 1970). Feeding activities of *Thais haemastoma* stop at temperatures of 10°C and below (Gunther, 1979). Such naticaceans as *Polinices dupli-*

*catus* in temperate zones cease to identify prey at about 5°C and a salinity of 6 ‰, whereas *Lunatia heros*, a species found generally in deeper water than *P. duplicatus*, continues its activities at temperatures as low as 2°C but to a salinity of only 10 ‰ (Hanks, 1952, 1953; Edwards & Huebner, 1977; Carriker, unpublished observations).

## PENETRATION OF PREY

### Selection of Borehole Site

#### Muricaceans

Little is known about borehole site selection by boring gastropods. *Urosalpinx cinerea*, after crawling onto an epifaunal bivalve, for example, undertakes a series of exploratory activities leading to selection of the penetration site. Exploration can range from a few minutes to half an hour. During the search the proboscis is extended intermittently to the shell surface, and, its tip undulating with minute wave-like movements, is passed slowly over the substratum, stopping now and then to rasp at small, live, sessile organisms (Carriker & Van Zandt, 1972a).

What determines the specific site for boring is unclear. Nor is it known whether individuals express a consistent preference for a particular part of the shell surface of successive prey, or whether an environmental cue plays a part in selection. *Urosalpinx cinerea* (Carriker & Van Zandt, 1972b) and *Nucella lapillus* (Morgan, 1972) appear to excavate boreholes randomly on prey valves, though *U. cinerea* locates its holes primarily away from the edge of the valves, reflecting avoidance of valve edges probably because of valvular motion. Breaks in valves away from valve edges, or along valve edges when valves are held shut by rubber bands, are quickly located and used as penetration sites in lieu of boring through solid shell. It appears that metabolites from active living, non-wounded prey not only trigger the initial attack on prey, but also determine penetration sites when seepage occurs through tiny holes between valve edges. Thus, tightly closed living oysters are not penetrated, nor are empty valves bored even in the presence of attractant from pumping oysters nearby (Carriker & Van Zandt, 1972a). In contrast to *U. cinerea*, *Acanthina spirata* bores holes most commonly at the margin of the prey valves (Hemingway, 1973),

and *Dicathais aegrota*, away from the margin of the univalve of the limpet (Black, 1978).

### Naticaceans

A series of behavioral patterns involving prey capture and prey manipulation, present upon metamorphosis of the snails, determines the position of the borehole in this group (Berg, 1976). These gastropods, characterized by an exceptionally large, flat foot that facilitates their movements within the sediment and with which they tightly grip their prey, crawl through clean to slightly muddy sand both above and below the sediment-water interface. When infaunal prey are located, probably chemoreceptively, snails burrow rapidly to their level, and generally bore into the shell below the benthic surface.

In the process of prey capture, these naticids secrete copious quantities of mucus. In the laboratory *Lunatia nitida* covers its prey with mucus to help hold the prey closed and prevent it from escaping (Richter, 1962). In some cases, after coating its prey, *L. nitida* tows the bivalve behind it by a rope of mucus, the prey held closed by the mucus sheet until the snail is ready to bore into it. *L. heros*, likewise in the laboratory, sometimes places a bivalve in a pocket formed by underfolding of the posterior part of the foot, and carries the prey there until ready to consume it (personal observation).

Positions for boring seem to be related to the manner in which prey are grasped, and holes are thus usually limited to a small area of prey valves, commonly on one valve more frequently than the other. Position of boreholes appears to vary with the species of predator and prey (Boettger, 1930; Ziegelmeier, 1954; Fretter & Graham, 1962; Carriker & Yochelson, 1968; Taylor et al., 1980). Berg (1976) found that after metamorphosis young *Natica gualtieriana* bored their first prey by a single hole in a stereotyped position. As these snails matured and gained experience at boring, there was no change in the angular distribution of the boreholes in each whorl, but whorl preference changed.

### Shell Penetration

### Muricaceans

All muricids that have been studied closely employ a similar chemical-mechanical mechanism for penetration of prey valves

though the manner of penetration may vary (Carriker & Van Zandt, 1972b; Morgan, 1972; Gunter, 1979). For example, once *Urosalpinx cinerea* has commenced excavation of a borehole, it continues until penetration has been completed. Only dislodgment of the snail by exterior forces or precipitous environmental changes are apt to terminate boring; and even then, many snails, if remaining close by the borehole, will return to the hole. *U. cinerea* can penetrate the shell of its prey in the absence of the live animal, provided boring has been initiated on live whole prey. Thus, boreholes once started can be completed without stimulation of any kind from live prey (Carriker & Van Zandt, 1972a; Carriker, Van Zandt & Grant, 1978). On the other hand a young *Thais haemastoma* bores holes on a valve until it reaches a height of 5 cm; at larger sizes it penetrates at valve edges apparently relaxing prey by a paralytic substance, and in one-third of the oysters consumed, boring no hole (McGraw & Gunter, 1972; Krutak, 1977; Gunter, 1979).

Initial identification of a boring site by *Urosalpinx cinerea* is made by the propodium and by the proboscis tip. In early stages of exploration, the snail frequently extends and passes its proboscis over the spot, and occasionally the mouth opens and the buccal cavity enlarges in what appears to be a "tasting" reaction. Anterior propodial ridges are used only partially, and sometimes not at all, in supporting the proboscis during search for a penetrating site (Carriker, 1943; Carriker & Van Zandt, 1972a).

After the boring site is selected, the snail positions itself on the shell surface with the pore of the retracted ABO located over the prospective boring site. Thereafter the posterior part of the foot remains firmly attached to the shell in the same position. The anterior part of the propodium is then retracted deeply, and the lateral propodial ridges are overfolded, forming a fleshy tube over the borehole site down which the proboscis is extended. Rasping is limited principally to the bottom of the incomplete borehole. The odontophore can rotate on its long axis independent of rotation of the proboscis by at least 180°; thus, by swinging to the left and then to the right in two half turns, the odontophore covers the circumference of the borehole. Rasping over the surface of the incomplete borehole by the radula is uniformly firm, and the pattern of rasping appears random (Carriker & Van Zandt, 1972a).

After the brief rasping period, the proboscis is infolded into the cephalic hemocoel. Simultaneously the mid-anterior part of the propodium, already at the posterior edge of the borehole where it surrounded the proboscis, is extended into the borehole. The propodium then presses the transverse furrow (Fretter & Graham, 1962) closely against the shell, slides it forward across the surface of the incomplete borehole and back onto the surface of the shell to assume a normally extended position and a tight contact between the epithelium of the snail's foot and the prey's shell. In this maneuver the propodium voids seawater from the incomplete borehole prior to entrance of the ABO. The propodium is followed immediately by the ABO which slides gently into position, and presses closely against the shell surface. Once in position, the organ continues to pulsate gently. During its stay in the borehole, the organ secretes solubilizing fluid that removes a thin layer of shell at the bottom and obliterates most of the marks of the previous rasping period. After the period of shell dissolution, the ABO is withdrawn from the borehole. Simultaneously, the propodial tube is formed, the proboscis is extended into the borehole to resume rasping, and a new penetration cycle commences. As soon as the borehole is completed and the break into the extrapallial space of the bivalve is large enough to admit the proboscis, the snail presses the proboscis against the flesh and starts feeding (Carriker & Van Zandt, 1972a). The boring behavior of *Eupleura caudata*, as observed in oyster models (Carriker & Van Zandt, 1972a), is identical to that of *Urosalpinx cinerea*. The boring behavior of *Nucella lapillus* is said to be similar to that of *U. cinerea* (Morgan, 1972). Using a motion picture camera taking single exposures every 1.5 minutes, Morgan showed that in the period of 73.3 hours required to bore, *N. lapillus*, like *U. cinerea*, moved its position on the prey only slightly.

#### Naticaceans

Because these snails wrap prey in the foot during boring and bore primarily when buried in the sand (Fretter & Graham, 1962), it is difficult to study their shell-penetration process. Ziegelmeier's (1954) account of *Lunatia nitida* is the most detailed. The bivalve is held by the propodium, which overfolds much as does that of muricids, to form a fleshy tube down which the long proboscis is extended

from the cephalic hemocoel to the surface of the prey shell. During penetration the proboscis is rotated a 90° quadrant at a time so that rasping is done systematically sector by sector from the center of the incomplete borehole to the periphery. The center of the hole, where the least radular rasping occurs, thus results in a boss characteristic of incomplete naticacean boreholes. After the rasping of a quadrant, the proboscis is raised from the incomplete borehole and the ABO, located under the ventral lip, is placed in the hole. (Ziegelmeier was not able to see the change in position.) As in muricids, the ABO solubilizes the surface layer of shell in the borehole, and the weakened shell is rasped free by the radula during the next round of mechanical boring. In *Urosalpinx cinerea* the process of hole boring is easily observed in an oyster model (Carriker & Van Zandt, 1972a); no apparatus has yet been devised to permit viewing of the process in naticaceans. Nonetheless, from the information available, and from general observations on feeding by *Lunatia heros*, *L. triseriata*, and *Polinices duplicatus* in the laboratory (Carriker, personal observations), it appears that the mechanism of shell penetration in muricaceans and naticaceans is similar (see also Fretter & Graham, 1962).

#### Proboscis and Radula

##### Proboscis

A long proboscis evolved in prosobranchs that feed on food not immediately accessible to them (Fretter & Graham, 1962; Graham, 1973). In boring prosobranchs, the length of the proboscis is about as long as the height of the shell. This is a distinct advantage because predators can not only bore a hole in the shell of prey, but can also extend the proboscis deep into prey to feed safely within a wide radius of soft tissues until the valves of prey gape. When valves open, nearby predators, especially small crabs, join in feeding. In view of the predatory success of both groups of snails, the muricacean pleurembolic and the naticacean acrembolic types of proboscides appear to be equally effective (Carriker, 1943). After the muricacean proboscis is amputated accidentally by being pinched between valves of prey, by small crabs feeding alongside the proboscis in gaping prey, or by experimental procedures in the laboratory, it regenerates rapidly to its former size and



function (*Urosalpinx cinerea*, *Eupleura caudata*: Carriker, Person, Libbin & Van Zandt, 1972; *Thais haemastoma*: Gunter, 1968). Loss of this important organ is thus not fatal, as the snail possesses enough metabolic reserves to survive until a new proboscis has formed. In the absence of the proboscis the snail is unable to bore, even though the ABO is present. The regenerative capacity of the proboscis of naticaceans has not been tested, but it is likely that it, too, can reform in the event of accidental proboscisectomy.

### Radula

Although radulae of muricaceans (rachi-glossan, formula  $1 + R + 1$ ) and naticaceans (taenioglossan, formula  $2 + 1 + R + 1 + 2$ ) differ in organization, they are both long, slender structures limited to a few teeth in each transverse row. The narrow radula is admirably adapted to hole boring, the central rachidian tooth in each row bearing the brunt of rasping over the surface of boreholes and the marginal teeth serving synchronously with rachidian teeth in tearing flesh from prey (Carriker, Schaadt & Peters, 1974; Krutak, 1977).

The radula of boring gastropods has been a favorite subject for light (25 species of muricids: Wu, 1965b) and scanning electron microscopy (*Urosalpinx cinerea*: Carriker & Van Zandt, 1972a, Carriker, Schaadt & Peters, 1974; *Nucella lapillus*: Runham, 1969; several species of *Acanthina* and *Eupleura triquetra*: Hemingway, 1975a, b; *Thais haemastoma*: Krutak, 1977). Scanning microscopy shows admirably the successive locking of each tooth over its neighbor, spreading the impact against the shell surface over several rachidian teeth as the radula slides over the tip of the odontophore against the borehole. Independent forward movement of the radula over odontophoral cartilages as the radula scrapes forward against the borehole adds efficiency to the shell-rasping process and spreads the wear of cusp tips over several rows of rachidian teeth (Carriker & Van Zandt, 1972a; Carriker, Schaadt & Peters, 1974). Hole boring wears the teeth down to their base. Gradual replacement of the radula by formation of new teeth in the radular sac insures that a supply of sharp teeth is available for each successive round of shell-boring (Isarankura & Runham, 1968).

Hardness of radular teeth is known only for muricids (Carriker & Van Zandt, 1972b); naticid teeth have not been tested. The mar-

ginal teeth of *Urosalpinx cinerea* are about twice as hard as rachidian teeth, and the latter are about the same hardness as oyster shell. Thus, without the aid of the solubilizer secreted by the accessory boring organ, the radula would make little progress into the shell. Calcium is a major chemical element of the teeth of *U. cinerea* and strontium and silicon are present as major to trace constituents (Carriker & Van Zandt, 1972a). Abrasion of radular teeth during boring wears cusps smoothly. No sharpening occurs as it does in teeth of the grazer, *Patella vulgata*, in which the leading edge of each tooth is backed by a softer region that insures self-sharpening of this edge during wear (Runham, Thornton, Shaw & Wayte, 1969).

Unworn teeth of boring gastropods are exceedingly sharp and could readily shred the lining of the buccal cavity during boring and feeding. This is generally avoided by a protective, flexible, cuticularized buccal armature that lines the buccal cavity and prevents damage to buccal tissues. Even so, light abrasion still occurs on the more elevated parts of the buccal lining, but this lining is augmented further by secretion from the buccal epithelia (Carriker, Schaadt & Peters, 1974).

As demonstrated in *Urosalpinx cinerea*, gastropod borers swallow fragments of shell rasped from the borehole during penetration of prey (Carriker, 1977). Depending on their orientation relative to the surface of the incomplete borehole, shell units (prisms, lamellae) are broken off, coated with secretion from the ABO, and further pelleted by mucus on their passage down the alimentary canal to be voided as feces. The envelope of mucoid material undoubtedly reduces or prevents laceration of the epithelium of the alimentary canal. Naticaceans also swallow shell fragments scraped from the borehole (Ziegelmeier, 1954; Fretter & Graham, 1962). These also pass down the esophagus and appear outside the anus as white fecal pellets. Since most shell excavated from boreholes appears to be discharged through the anus, it is questionable that minerals in shell fragments are used metabolically by snails to any extent. The matter should be investigated by tagging shell of prey with radioactive calcium.

### Accessory Boring Organ

The ABO is an essential component of the shell penetrating mechanism of boring gastro-

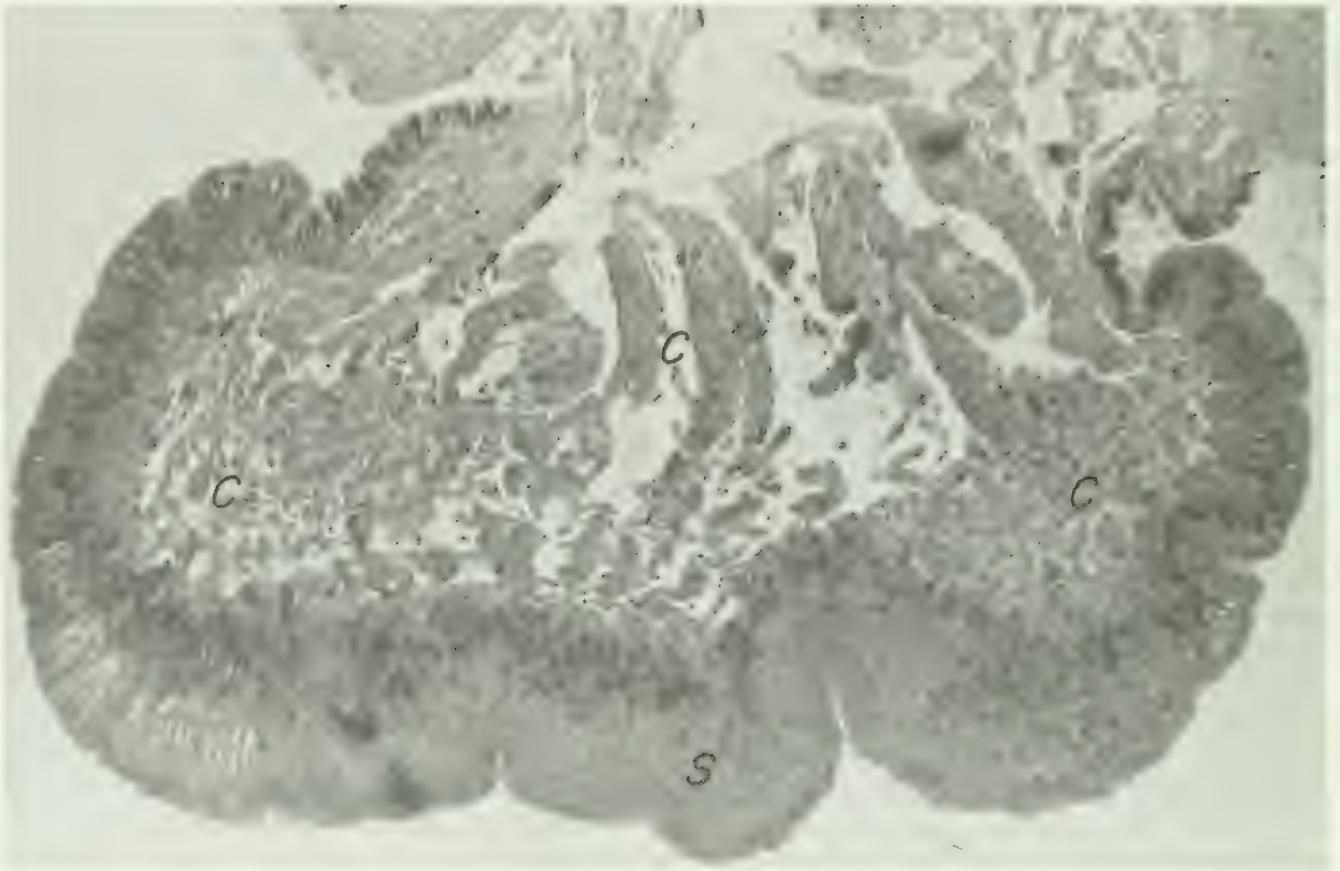

FIG. 5. Light micrograph of histological sagittal section of accessory boring organ of *Urosalpinx cinerea follyensis* extended from foot. S, secretory epithelium. C, connective tissue in center of organ supporting retractor muscles, capillaries, and nerve fibers. Organ 1 mm in diameter.

pods (Fig. 5). When this organ is removed from, for example, *Urosalpinx cinerea*, by experimental excision, the snail recovers, but is unable to bore, even though the proboscis is present and functional. The organ regenerates relatively rapidly, and the muricid soon resumes boring (Carriker & Van Zandt, 1972a). The effect of removal of the ABO on the shell penetrating capacity of a naticacean has not been determined, but is likely similar to that observed in muricids.

All species of boring muricacean and naticacean gastropods that have been studied to date possess an ABO, but these constitute only a small sample of the large number of species of boring gastropods that exist in the world oceans. Many more species need to be examined before we can generalize on the universality of a shell solubilizing gland in boring gastropods.

Detailed structural studies carried out so far on the ABO of two species of muricids (*Urosalpinx cinerea*: Nylen, Provenza & Carriker, 1969; and *Nucella lapillus*: Chétail, Binot & Bensalem, 1968; Derer, 1975; Webb & Saleuddin, 1977) and one species of naticid (*Polinices lewisi*: Bernard & Bagshaw, 1969)

show that the histology and fine structure of the secretory disc of the organ is similar in the three species. The organ of the naticid differs from that of the muricid organ in possessing a peripheral zone of subdermal mucocytes around the central disc. The peduncle that supports the disc is long and cylindrical in muricids, to accommodate the position of the gland deep within the foot, and short in naticids, in which the organ is attached to the lower lip of the proboscis (Webb & Saleuddin, 1977).

The secretory disc of the muricid and naticid ABO is composed of a single layer of tall columnar epithelial cells arranged in groups. A brush border of unusually long, densely packed microvilli covers the surface of the disc. The center of the organ consists of connective tissue that supports muscles, capillaries, and nerve fiber bundles passing to the base of the secretory epithelium. Dense populations of mitochondria are present near the surface of the epithelium, more abundant in secreting (ABO's of actively boring snails) than in resting (non-boring snails) secreting cells. Dense membrane-bound secretory granules, multivesicular bodies, and single

vesicles are also conspicuous in the cells (Nylen, Provenza & Carriker, 1968, 1969; Chétail, Binot & Bensalem, 1968; Bernard & Bagshaw, 1969; Derer, 1975; Webb & Saleuddin, 1977).

Whereas the mechanical phase of shell penetration by the radula is well understood (Carriker, Schaadt & Peters, 1974), knowledge of the chemical phase is still in a hypothetical state. Earliest physiological research on the ABO of muricids disclosed, a) a pH ranging from 3.8 to 4.1 in the released secretion of a normally functioning gland (Carriker, Van Zandt & Charlton, 1967), b) active aerobic metabolism in the secretory cells (Person, Smarsh, Lipson & Carriker, 1967), and, c) substantial amounts of carbonic anhydrase in the organ (Carriker, Person, Smarsh, Lipson & Chauncey, 1968; Chétail, Binot & Bensalem, 1968). Subsequent research on the chemical phase of penetration was summarized by Carriker & Williams (1978). They hypothesized that a combination of enzymes, an inorganic acid (possibly HCl), and possibly chelating agents is employed in a hypertonic secretion to facilitate dissolution of shell and intracellular transport of calcium during the chemical phase of shell penetration. Secretion granules and vesicles in the secretory epithelium of the ABO and in the released secretion, organic matter in the secretion, and inactivation by heat and papain of the etching capacity of excised ABO's suggest the presence of enzymes. Hydrogen, chloride, and sodium ion concentrations demonstrate the hypertonic and acidic nature of the released secretion. An unidentified chelating agent and a mucoprotein appear to be present in the secretory epithelium; the latter perhaps is the chelator. In a study of lysosomal enzymes, acid phosphatase, and carbonic anhydrase in the ABO of *Nucella lapillus*, Webb & Saleuddin (1977) concluded that there is minimal involvement of extracellular enzymes in the boring process. They postulated, instead, that hydrogen ions, derived from hydration of metabolic carbon dioxide, are released by the secretory epithelium for dissolution of calcium carbonate of the shell. This supports the earlier findings by Carriker, Van Zandt & Carlton (1967) on the pH of the secretion in *Urosalpinx cinerea*. However, the findings of Webb & Saleuddin (1977) on extracellular enzymes are at variance with those of Carriker and Chauncey (1973) who reported that released secretion collected from live *U. cinerea* was positive for carbonic anhydrase.

The similarity determined by scanning electron microscopy of ultrastructural patterns of dissolution etched in the shell of *Mytilus edulis* by the secretion of the ABO and those produced artificially by HCl and ethylenediaminetetra-acetic acid, suggest that these chemicals, or similar ones are constituents of the secretion of the ABO. Lactic and succinic acids and a chitinase-like enzyme were also suggested as possible components. However, alteration of shell fracture surfaces by experimental application of these and other chemical agents was not sufficiently comparable to that etched by the secretion of the ABO to support this suggestion.

A marked variation in the rate of dissolution of different ultra-structural parts of the mineral components of shell occurs in shell surfaces when they are etched by the secretion of the ABO (Carriker, 1978). As differential dissolution could result, in part, from variation in the composition of trace and minor mineral constituents of shell, Carriker, Van Zandt & Grant (1978) tested the capacity of *Urosalpinx cinerea* to penetrate several kinds of non-molluscan minerals commonly present in trace or minor amounts in bivalve shell. The rate of penetration of these minerals decreased in the following order: bivalve (mainly  $\text{CaCO}_3$ ) shell, strontianite ( $\text{SrCO}_3$ ), anhydrite ( $\text{CaSO}_4$ ), witherite ( $\text{BaCO}_3$ ), and magnesite ( $\text{MgCO}_3$ ), lending support to the original hypothesis of differential dissolution (Carriker, 1978). A variety of biogenically formed calcareous minerals was also tested, and all of these, except the radula of *U. cinerea*, were penetrated. The relative resistance of radular teeth to dissolution by the secretion is not unexpected, since the radula is exposed to the secretion for a relatively long time during penetration. Clearly, much more research must be carried out on the chemical phase of penetration before the mechanism can be fully understood.

The anatomical location and structure of organs involved in hole boring by other molluscan penetrants such as cymatiid mesogastropods (Day, 1969), vayssiérid nudibranchs (Young, 1969), and octopuses (Nixon, in press) are significantly different from those of the accessory boring organ in muricaceans and naticaceans, yet the shell of their prey is penetrated effectively. Study of the chemical mechanism of shell excavation by these predators should provide a deeper understanding of shell penetration by muricaceans and naticaceans than is now available.

### Tubular Salivary Glands

Two kidney-shaped, muscular, tubular salivary glands (also known as accessory salivary glands) discharge through a common duct into the ventral lip of the mouth of most muricaceans (Table 1; Graham, 1941; Carriker, 1943; Fretter & Graham, 1962; Carriker, 1977). These glands are distinctive morphological features of the Muricidae (Ponder, 1973). Four separate functions have been hypothesized for the glands:

**Lubrication.** Discharge of the secretion of the glands into the path of the functioning odontophore suggests a source (in addition to that from the salivary glands) of lubricant for the radula during the boring process (Fretter & Graham, 1962). This suggestion is supported by the fact that the spongy layer about the mouth and opening of the tubular salivary gland duct in living *Urosalpinx cinerea* stain a deep purple-red color with methylene blue. (The only other external structures in the snail giving a similar staining reaction are the ventral and lateral surfaces of the foot that secrete copious quantities of mucus.) (Carriker, 1943). Furthermore, extracts of the glands of *Nucella lapillus* and *Ocenebra erinacea* have a pH of about 6.0, application of the glands or their extracts to the polished inner surface of mollusc shell leaves no etched mark and no proteolytic or amyolytic enzymes appear to be present (Graham, 1941). In contrast the secretion of the ABO when applied to polished shell does etch (Carriker & Van Zandt, 1964).

**Hole boring.** That the glands could also be involved in shell penetration may be deduced from their position in the distal end of the proboscis, but there is little else to support this conjecture. These glands are present in most muricaceans (Table 1) in which they vary in relative size, and are absent in naticaceans and apparently also in nonboring gastropods. Conceivably the unexplained role of muricacean tubular salivary glands could be equivalent to that of the mucocytes that surround the naticacean ABO (Carriker, 1977), but there is no information on this. What structure replaces the tubular salivary glands in muricaceans that lack them has not been determined.

**Paralysis.** The histological resemblance between tubular salivary glands and the poison gland of toxoglossans (Graham, 1941; Fretter & Graham, 1962) suggested to Graham (1941) and to Martoja (1971) that tubular sali-

vary glands could produce some toxic substance. Graham (1941), however, found that their extract has no effect on the heart of *Cardium* sp., and noted that many prey of boring gastropods are sedentary and do not have to be paralyzed before consumption. A further point that might have a bearing on the problem is that salivary glands of stenoglossans (*Ocenebra aciculata*, for example) lack alkaline phosphatase in their cells, while both the tubular salivary glands and the gland of Leiblein are rich in this enzyme (Franc, 1952; Fretter & Graham, 1962).

Because of their intrinsic biological interest, and their possible involvement in shell penetration, tubular salivary glands of muricaceans deserve further attention.

### Extracorporeal Enzymes

From experiments on attraction of hermit crabs to simulated gastropod predation sites, Rittschof (1980, in press) suggested that gastropod predators (such as the fascioliids *Pleuroploca gigantea* and *Fasciolaria tulipa*) release a protease while feeding. Peptides released from gastropod prey while predators consume prey flesh serve as cues that enhance the attractiveness of prey several times over that of prey flesh alone. Rittschof supported his hypothesis by addition of trypsin to prey flesh which in the absence of a predator made the flesh as attractive to hermit crabs as was prey flesh being actively consumed by a gastropod predator.

This finding has significant implications for the study of shell penetration. Boring gastropods possess salivary glands, buccal glands, and in the case of most muricaceans, tubular salivary glands that empty directly into the buccal cavity. Mansour-Bek (1934) reported the presence of proteolytic enzymes including a trypsin-like protease in the saliva (presumably from the salivary glands) of *Murex anguliferus*. Enzymes discharged into the buccal cavity around odontophore and radula could easily trickle into the borehole during the rasping phase of shell penetration, and if a constituent of the secretion were a concholinase-type enzyme, attack the organic components of the shell (Carriker, 1969; Travis & Gonsalves, 1969). If the enzymes aid in shell penetration, they should be demonstrable during boring but prior to feeding. Preliminary attempts by Carriker (1978) to identify enzymes that hydrolyze the intercrystalline organic matrix of shell were inconclusive and

should be repeated. Until now, we have hypothesized that shell solubilizing enzymes, if present, are secreted by the ABO (Carriker & Williams, 1978). Identification of hydrolytic enzymes in the buccal region of boring gastropods, and testing of these enzymes on shell preparations should thus provide additional information on the chemical phase of shell penetration.

#### Anterior Pedal Mucous Gland

This gland is a collection of clusters of sub-epithelial secretory cells arranged in nests in the anterior part of the foot. The gland discharges into a sagittal canal that empties into the transverse furrow between the propodium and the podium (Fretter & Graham, 1962). The propodium sweeps across the bottom of the incomplete borehole during boring, and the furrow, in an anatomical position to wipe secretion over the surface of the hole, is carried along. Most of the cells of the gland stain so as to suggest that their secretion contains mucoprotein. These constituents, if present, could function as chelating agents in solubilization (Carriker & Williams, 1978). The pH of the secretion in the furrow ranges from 7.0 to 7.8 (Carriker, Williams & Van Zandt, 1978). However, shell etched by the secretion from the ABO in the absence of furrow secretion, revealed the normal pattern of dissolution found in boreholes (Carriker, 1978). The role of the secretion in shell penetration is thus uncertain; at the least the secretion could serve as a lubricant and as a sealant to hold the ABO secretion within the bore hole. Study of the gland needs to be undertaken before the chemical mechanism of shell penetration by boring gastropods can be fully understood.

#### PARALYSIS OF PREY

That some muricacean gastropods synthesize biotoxins to quiet or kill their prey has been suspected for some time (Gunter, 1968). For example, while most boring gastropods bore a hole large enough to admit the proboscis, adult *Thais haemastoma* bore comparatively small holes at the valve margins that do not admit the proboscis. This fact, together with behavioral observations, suggested to McGraw & Gunter (1972) and Gunter (1968, 1979) that *T. haemastoma* injects a paralytic substance into prey that causes them to gape and die.

Paralytic agents, elaborated in the hypobranchial gland (Whittaker & Michelson, 1954; Whittaker, 1960; Edean, 1972; Hemingway, 1978), have been identified as pharmacologically active esters of choline: urocanylcholine (in *Murex trunculus*, *M. fulvescens*, *Ocenebra erinacea*, *Nucella lapillus*, and *Urosalpinx cinerea*), and seneciolycholine (in *Thais floridana*). Acrylylcholine is present in the nonboring snail *Buccinum undatum*, but no choline esters occur in *Busycon canaliculatum* or in several species of taenioglossans (Whittaker, 1960). The salivary glands of nonboring species of buccinids and cymatiids contain tetramine in addition to choline esters. The hypobranchial gland secretes mucus containing both Tyrian purple and the choline ester that is probably carried to prey by ciliary currents on the surface of the mantle and propodium (Whittaker, 1960; Hemingway, 1978). Urocanylcholine has marked hypertensive as well as a neuromuscular blocking action. Seneciolycholine resembles urocanylcholine but is somewhat less active as a blocking agent, acrylylcholine has only an extremely brief and feeble blocking action (Whittaker, 1960). The first two biotoxins are present in shell boring gastropods and the third in a nonboring gastropod.

A paralytic substance with a high acetylcholine equivalency is also present in the combined salivary and tubular salivary gland complex (as well as in the hypobranchial gland) of the muricid, *Acanthina spirata* (Hemingway, 1973, 1978). As analyses were performed on the combined glands, it is not clear whether one or both of the glands release the biotoxin. Graham's (1941) report, that extract of tubular salivary glands has no effect when injected into the heart of a bivalve, suggests that the acetylcholine is produced by the salivary glands. The matter requires verification.

Hemingway (1978) noted that different choline esters in the hypobranchial glands of predatory gastropods may be as numerous as the species of muricaceans (see also Whittaker, 1960). The apparent specificity of choline esters from these glands led Feare (1971) to make the provocative suggestion that choline esters released by them could also be involved in species recognition or mating behavior! It is understandable that a predator, like *Buccinum undatum*, which attacks bivalve prey without boring through the shell, would be aided in attacking prey by pro-

ducing acrylylcholine, but not why shell-penetrating muricaceans, which prey on bivalves that are generally sedentary (Graham, 1941), release urocanylcholine that has a strong blocking action.

No reports are available on whether glands in the proboscis or mantle cavity of naticaceans emit paralytic chemicals. Since these gastropods bind prey in large quantities of mucus during capture and manipulation prior to boring, the mucus itself, secreted presumably by pedal surfaces, could contain paralytic substances. These interesting possibilities call for attention.

### EVOLUTION

The greatest known concentration of muricacean and naticacean borers occurs in shallow water around continents in tropical latitudes (Carriker, 1961; Taylor et al., 1980). Since no boring gastropods have been discovered in freshwater (Carriker & Smith, 1969), and relatively few borers have been reported from the deep-sea (Carriker, 1961; Taylor et al., 1980), it is likely the shell boring habit in prosobranchs evolved in relatively shallow, tropical, marine waters (see also Clarke, 1962).

Gastropods presently known to bore holes in shells of prey date back to the Jurassic and perhaps as early as the Late Triassic, some 200 million years ago (Carriker & Yochelson, 1968; Sohl, 1969; Ponder, 1973; Krutak, 1977; Taylor et al., 1980). Evolution of the shell-penetrating mechanism in muricaceans and naticaceans could have taken place in three major morphological steps in this order in geologic time: a) development of the radula (Firby & Durham, 1974; Krutak, 1977; Taylor et al., 1980), b) elongation of the head to form a proboscis (Graham, 1973), and c) formation of the accessory boring organ (Carriker, 1943; Fretter, 1941, 1946). The mechanism for secretion of paralytic substances could have evolved after the appearance of the radula (Taylor et al., 1980) and could have preadapted snails to become predators of non-shelled prey.

Appearance of the ABO in two separate anatomical locations among muricaceans (in front of the ventral pedal gland, and atop the ventral pedal gland) and in an entirely different region in naticaceans—under the proboscis tip (Carriker, 1961)—is an enigma. Difference in the position of the organ in the two

superfamilies might be attributed to the strikingly different epifaunal and infaunal boring behaviors, respectively, of the two groups. However, the general position of the anterior central part of the foot of the predator on its prey, the placement of the organ in the borehole, and alternation of radula and organ in the borehole during penetration are similar in the two superfamilies and within the muricaceans. A comparative embryological study of the development of the ABO in representative muricaceans and naticaceans is urgently needed to determine whether the organ develops anew in its respective anatomical spot in different groups, or is formed in one place and migrates to its definitive position in the adult. In any event, the development of such similar organs as the ABO on different parts of the body is one of the most interesting parallels in molluscan morphology (Bernard & Bagshaw, 1969).

It is curious that the ABO seems to have evolved only in muricaceans and naticaceans, and not in other predatory molluscs. Whether all species of these two distantly related superfamilies possess an accessory boring organ has not been determined. Too few species have been examined to permit a generalization. There is, for example, an omnivorous muricid, *Drupa ricina*, pedal anatomy unknown, that feeds on sponges, holothurians, and carrion, and is not thought to be a typical predator of hard-shelled molluscs (Wu, 1965a). Its tubular salivary glands are fully developed. It will be important to determine whether this snail possesses a fully developed, or a vestigial, ABO, or none at all.

Shell dissolution in muricaceans is not limited to shell boring. The mantle edge of spiny muricids, for example, dissolves spines at their base as the body whorl is deposited from one varix to the next, to eliminate blockage of the aperture (Carriker, 1972). The broad temporal, spatial, and systematic distribution of calcibiocavites, the capacity for dissolution of shell by many invertebrates in noncalcibiocavitic activities, and the prominence of osteoclastic activity in the vertebrates, suggest that calcibiocavitation may be a latent and fundamental characteristic of organisms, expressing itself especially in epithelia, that has appeared from time to time without regard to systematic or morphological position (Carriker & Smith, 1969).

Evolution of the proboscis and the ABO opened to boring gastropods a broad spectrum of prey not otherwise easily available,

and undoubtedly has helped account for the historical longevity and ubiquity of the group (Carriker & Van Zandt, 1972a). In the event of loss of either the proboscis or the ABO, through pinching or amputation during penetration of prey, relatively rapid functional regeneration of both organs occurs (Carriker & Van Zandt, 1972b; Carriker, Person, Libbin & Van Zandt, 1972)—a unique safeguard insuring full replacement of the mechanism and survival of the organism through geologic time.

### CONTROL

During the last 50 years shellfish growers and shellfish biologists have devoted considerable time and effort in attempts to control muricacean predators. Examples of better known predators include *Eupleura caudata*, *Ocenebra inornata* (= *japonica*), *Thais haemastoma*, and *Urosalpinx cinerea* in the United States; *Ocenebra erinacea* and *Urosalpinx cinerea* in Great Britain; *Ocenebra inornata*, *Rapana thomasi*, *Thais bronni*, and *T. tumulosa* in Japan; and *Bedevea hanleyi* and *Morula marginalba* in Australia. There are many other species in other regions of the world.

Efforts to control muricacean borers (also called drills) by physical methods have met only with partial, and then only temporary, success. Hand picking, forks, concrete pillars, oyster dredges, deck screens, drill dredges, drill box traps, and drill trapping of *Urosalpinx cinerea* have all been tried more or less intensively. A more mechanical, less labor intensive method employing a hydraulic suction dredge has been used with some success in the Long Island Sound area (Carriker, 1955). Loose material on the bottom is drawn onto a screened conveyer belt that allows oysters and shell to pass back overboard into the water. Fine materials, including oyster borers, collect in bins under the screen and are later discharged in shallow water to kill the borers by suffocation. The suction dredge is limited to dredging in intermediate depths of water, and on relatively firm bottoms. Invention of a more economical method of disposing of the snails than currently used would significantly reduce the cost of this method of control (Carriker, 1955; Hancock, 1959, 1969). Attempts to trap *Thais haemastoma* on oyster beds have been unsuccessful because no baits more attractive than the surrounding

oysters and mussels have been found (Gunter, 1979).

Efforts to eradicate muricacean predators and their young by desiccation, flaming, fresh and brine waters, magnesium sulfate, copper sulfate, mercuric chloride, formalin, rotenone and chlorinated benzene, and other chemicals have been ineffective on a commercial scale, or effective, but too harmful to other organisms and the environment to be employed (Carriker, 1955; Castagna, Haven & Whitcomb, 1969). Copper barriers have also been suggested by Glude (1956) and Huguenin (1977), but these, like other metals, would contaminate the environment, and their application would be labor intensive and costly. The use of freshwater curtains, created by release of fine streams of fresh water, to control muricacean borers has not been attempted, but merits consideration (D. Rittschof, personal communication).

Naticaceans (moon snails), serious predators of infaunal bivalves, decimate populations of such commercially important species as *Mya arenaria* and *Mercenaria mercenaria* in estuaries and embayments and *Spisula solidissima* on the continental shelf (Franz, 1977). Abortive attempts have been made to control them by manual collecting in the intertidal zone (for example, *Lunatia heros*, Medcof & Thurber, 1958). As with similar attempts at control of muricaceans, this method has serious limitations, primarily because these predators occur subtidally as well and soon replace those removed from the intertidal zone.

The response of boring gastropods to attractive chemical signals from prey, or from female snails during mating, or repulsion of them by unattractive biochemical cues from other organisms, provide the basis for possible ecological control. Attractive or unattractive chemical signals, if they can be identified and synthesized, could possibly be used as bait in trapping, or as dispersive or repelling agents. A great advantage of such signals is that they are biodegradable, and would not contaminate the environment. Ideally they might be species specific.

### CONCLUSIONS

Interest in organisms that penetrate hard calcareous substrata dates back many centuries. Aristotle, some 2,300 years ago, is credited for recognizing that predatory marine

gastropods have the capacity to bore holes through shells of prey (Jensen, 1951). Since then advances in the knowledge of shell penetration by boring gastropods has been rapid (Carriker & Smith, 1969; present review). In spite of this progress, however, several important aspects of the biology of shell penetration require further study; these are summarized in this section.

Information on the zoogeographical distribution of boring gastropods is limited, not only in shallow coastal areas but more so in the deep-sea (Clarke, 1962), and is difficult to obtain. Bore holes in prey shell indicate the presence of borers in the geographic vicinity, but provide no clues on the specific identity of the borers. Identification of shell penetrants can be determined by holding snails in aquaria with potential prey, and observing whether hole boring takes place. This procedure generally works well with snails from shallow water, but could be difficult with gastropods from the deep-sea even in pressurized aquaria. A more practical approach would be to examine suspected shell penetrants for the presence of the ABO by anatomical and histological techniques.

All naticacean and muricacean gastropods studied so far possess an ABO and are shell borers. Whether all species of these superfamilies are borers needs to be determined by examination of a wide spectrum of species of these groups, as well as non-naticacean-muricacean predators, from widely different regions of the oceans.

The ABO is known to occur in three different anatomical positions in different species of boring gastropods. However, the number of species that has been examined is small, and it is possible that the ABO could occur in other than the described anatomical locations. The ABO appears to be proportionately larger in young individuals than in adult ones (for example, *Thais haemastoma*; Gunter, 1968, 1979). This condition is not characteristic of most gastropod boring species, and could be interpreted as suggesting that this species has evolved toward a lesser use of the ABO in adults than in the young. On the other hand, species of borers could exist in which the ABO is an incipient organ, and the snails could be evolving either toward or away from the boring habit. A species worth exploring in this regard is *Drupa ricina* (Wu, 1965a). The study of transitional stages of the ABO, as well as the embryological development of the ABO in different anatomical

positions, would be of considerable evolutionary interest.

From an ecological and behavioral point of view it is of interest to know whether the chemical attractant associated with each prey species is a single, or a combination of different molecules, and whether attractants are species specific. This fundamental information is prerequisite to the formulation of a bait for control of these predatory snails.

Although substantial progress has been made in the study of the behavior of shell penetration by boring gastropods and of the gross and fine structure of the ABO, we know rather little about the chemical aspects of shell penetration. Study of the chemistry of the ABO secretion is difficult because the ABO is a relatively small organ, and amounts of released secretion are very small. The presence of a mild acid in the secretion has been verified with pH electrodes, but the composition of the acid, suspected of being HCl, is uncertain. Preliminary observations suggest that an unidentified enzyme(s) and chelator(s) may be components of the active shell solubilizing secretion. This needs confirmation.

The ABO is probably the principal organ involved in the chemical phase of shell penetration. However, close association of duct openings of the salivary glands, buccal glands and tubular salivary glands with the buccal cavity and mouth, and of the anterior pedal mucous gland with the anterior part of the foot, suggests that these glands could play at least a part in the mechanism of shell penetration. Their potential role cannot be discounted until more is known about their functions.

Some boring gastropods appear to be able to quiet or kill their prey by applying a paralytic substance to them through the borehole. Suspected sources of paralytic agents are the hypobranchial gland, salivary glands, and tubular salivary glands. Whether salivary glands can secrete both paralytic and shell solubilizing substances is questionable, but worth exploring. The source of these biotoxins, the method of injection into prey, and the physiological effect on prey also need investigation.

Shell swallowed by boring gastropods apparently passes through the alimentary canal and is voided relatively unchanged in feces. There is the possibility, however, that some nutrients could be extracted from the organic and inorganic components of shell fragments in the stomach of the snail and absorbed. The



metabolic fate of absorbed nutrients, if any, could be tested with radioactive tracers.

Costly depredations by boring gastropods of commercial bivalve populations in all parts of the world confer a high priority on these snails as subjects for the investigations proposed in this synthesis. Especially important would be a search for components of the shell penetrating mechanism that might be blocked in order to control the predators. The results of such a study would benefit not only the shellfish industry but would also contribute new knowledge on the biology of predation by these ubiquitous, refractory—and very interesting—marine snails.

#### ACKNOWLEDGMENTS

My special thanks are extended to F. Bernard, B. Brown, T. Evans, J. Gordon, A. Kohn, R. Prezant, D. Rittschof, and L. Wood who kindly reviewed the manuscript and offered many valuable suggestions.

Preparation of the review was supported in part by the Delaware Sea Grant College Program.

College of Marine Studies Contribution No. 155.

#### LITERATURE CITED

- ABBOTT, R. T., 1974, *American Seashells. The Marine Mollusca of the Atlantic and Pacific Coasts of North America*. Ed. 2. Van Nostrand Reinhold, New York, 663 p.
- ARNOLD, J. M. & ARNOLD, K. O., 1969, Some aspects of hole-boring predation by *Octopus vulgaris*. *American Zoologist*, 9: 991–996.
- BARNETT, B. E., 1979, A laboratory study of predation by the dog-whelk *Nucella lapillus* on the barnacle *Elminius modestus* and *Balanus balanoides*. *Journal of the Marine Biological Association of the United Kingdom*, 59: 299–306.
- BAYNE, B. L. & SCULLARD, C., 1978, Rates of feeding by *Thais (Nucella) lapillus* (L.) *Journal of Experimental Marine Biology and Ecology*, 32: 113–129.
- BERG, C. J., Jr., 1976, Ontogeny of predatory behavior in marine snails (Prosobranchia: Naticidae). *Nautilus*, 90: 1–4.
- BERNARD, F. R. & BAGSHAW, J. W., 1969, Histology and fine structure of the accessory boring organ of *Polinices lewisi* (Gastropoda, Prosobranchiata). *Journal of the Fisheries Research Board of Canada*, 26: 1451–1457.
- BLACK, R., 1978, Tactics of whelks preying on limpets. *Marine Biology*, 46: 157–162.
- BOETTGER, C. R., 1930, Die Lage der Bohrstelle beim Angriff der Raubschnecken aus der Familie Naticidae. *Zeitschrift für wissenschaftliche Zoologie*, 126: 453–463.
- BURRELL, V. G., Jr., 1975, One oyster's solution to the drill problem. *Veliger*, 17: 334.
- CARRIKER, M. R., 1943, On the structure and function of the proboscis in the common oyster drill, *Urosalpinx cinerea* Say. *Journal of Morphology*, 73: 441–506.
- CARRIKER, M. R., 1954, Seasonal vertical movements of oyster drills (*Urosalpinx cinerea*). *Proceedings of the National Shellfisheries Association*, 45: 190–198.
- CARRIKER, M. R., 1955, Critical review of biology and control of oyster drills, *Urosalpinx* and *Eupleura*. *Fish and Wildlife Service, Special Scientific Report: Fisheries No. 148*: 1–150.
- CARRIKER, M. R., 1957, Preliminary study of behavior of newly hatched oyster drills, *Urosalpinx cinerea* (Say). *Journal of the Elisha Mitchell Scientific Society*, 73: 328–351.
- CARRIKER, M. R., 1961, Comparative functional morphology of boring mechanisms in gastropods. *American Zoologist*, 1: 263–266.
- CARRIKER, M. R., 1969, Excavation of boreholes by the gastropod, *Urosalpinx*: an analysis by light and scanning electron microscopy. *American Zoologist*, 9: 917–933.
- CARRIKER, M. R., 1972, Observations on removal of spines by muricid gastropods during shell growth. *Veliger*, 15: 69–74.
- CARRIKER, M. R., 1977, Ultrastructural evidence that gastropods swallow shell rasped during hole boring. *Biological Bulletin*, 152: 325–336.
- CARRIKER, M. R., 1978, Ultrastructural analysis of dissolution of shell of the bivalve *Mytilus edulis* by the accessory boring organ of the gastropod *Urosalpinx cinerea*. *Marine Biology*, 48: 105–134.
- CARRIKER, M. R. & CHAUNCEY, H. H., 1973, Effect of carbonic anhydrase inhibition on shell penetration by the muricid gastropod *Urosalpinx cinerea*. *Malacologia*, 12: 247–263.
- CARRIKER, M. R., PERSON, P., LIBBIN, R. & VAN ZANDT, D., 1972, Regeneration of the proboscis of muricid gastropods after amputation, with emphasis on the radula and cartilages. *Biological Bulletin*, 143: 317–331.
- CARRIKER, M. R., PERSON, P., SMARSH, A., LIPSON, S. & CHAUNCEY, H. H., 1968, Role of carbonic anhydrase in decalcification by *Urosalpinx cinerea follyensis* (oyster drill). *International Association for Dental Research, 46th General Meeting, and North American Division of IADR, March, 1968, Program and Abstracts of Papers*, p. 188, Abstract No. 604.
- CARRIKER, M. R., SCHAADT, J. G. & PETERS, V., 1974, Analysis by slow-motion picture photomicrography and scanning electron microscopy of radular function in *Urosalpinx cinerea follyensis* (Muricidae, Gastropoda) during shell penetration. *Marine Biology*, 25: 63–76.

- CARRIKER, M. R. & SMITH, E. H., 1969, Comparative calcibioecology: summary and conclusions. *American Zoologist*, 9: 1011–1020.
- CARRIKER, M. R., SMITH, E. H. & WILCE, R. T., 1969, Penetration of calcium carbonate substrates by lower plants and invertebrates, an international multidisciplinary symposium. *American Zoologist*, 9: 629–1020.
- CARRIKER, M. R. & VAN ZANDT, D., 1964, Use of polished mollusk shell for testing demineralization activity of accessory boring organ of muricid boring gastropods. *Biological Bulletin*, 127: 365.
- CARRIKER, M. R. & VAN ZANDT, D., 1972a, Regeneration of the accessory boring organ of muricid gastropods after excision. *Transactions of the American Microscopical Society*, 91: 455–466.
- CARRIKER, M. R. & VAN ZANDT, D., 1972b, Predatory behavior of a shell-boring muricid gastropod. In: WINN, H. E. & OLLA, B. L. (eds.), *Behavior of Marine Animals: Current Perspectives in Research*, Vol. 1, *Invertebrates*, Plenum, New York, p. 157–244.
- CARRIKER, M. R., VAN ZANDT, D. & CHARLTON, G., 1967, Gastropod *Urosalpinx*: pH of accessory boring organ while boring. *Science*, 158: 920–922.
- CARRIKER, M. R., VAN ZANDT, D. & GRANT, T. J., 1978, Penetration of molluscan and non-molluscan minerals by the boring gastropod *Urosalpinx cinerea*. *Biological Bulletin*, 155: 511–526.
- CARRIKER, M. R. & WILLIAMS, L. G., 1978, The chemical mechanism of shell dissolution by predatory boring gastropods; a review and an hypothesis. *Malacologia*, 17: 143–156.
- CARRIKER, M. R., WILLIAMS, L. G. & VAN ZANDT, D., 1978, Preliminary characterization of the secretion of the accessory boring organ of the shell-penetrating muricid gastropod *Urosalpinx cinerea*. *Malacologia*, 17: 125–142.
- CARRIKER, M. R. & YOCHELSON, E. L., 1968, Recent gastropod boreholes and Ordovician cylindrical borings. *Contributions to Paleontology, [United States] Geological Survey Professional Paper*, 593B: 1–26.
- CASTAGNA, M., HAVEN, D. S. & WHITCOMB, J. B., 1969, Treatment of shell cultch with polystyrene to increase the yield of seed oysters, *Crassostrea virginica*. *Proceedings of the National Shellfisheries Association*, 59: 84–90.
- CHÉTAIL, M., BINOT, D. & BENSALÉM, M., 1968, Organe de perforation de *Purpura lapillus* (L.) (Muricidae): histochimie et histoenzymologie. *Cahiers de Biologie Marine*, 9: 13–22.
- CHEW, K. K. & EISLER, R., 1958, A preliminary study of the feeding habits of the Japanese oyster drill, *Ocenebra japonica*. *Journal of the Fisheries Research Board of Canada*, 15: 529–535.
- CLARKE, A. H., Jr., 1962, On the composition, zoogeography, origin and age of the deep-sea mollusk fauna. *Deep-Sea Research*, 9: 291–306.
- CRISP, M., 1973, Fine structure of some prosobranch osphradia. *Marine Biology*, 22: 231–240.
- DAY, J. A., 1969, Feeding of the cymatiid gastropod, *Argobuccinum argus*, in relation to the structure of the proboscis and secretions of the proboscis gland. *American Zoologist*, 9: 909–919.
- DERER, M., 1975, L'organe de perforation de *Thais lapillus* L. (Gastéropodes, Prosobranches), étude en microscopie optique et électronique. *Archives d'Anatomie Microscopique et de Morphologie Expérimentale*, 64: 1–26.
- EDWARDS, D. C. & HUEBNER, J. D., 1977, Feeding and growth rates of *Polinices duplicatus* preying on *Mya arenaria* at Barnstable Harbor, Massachusetts. *Ecology*, 58: 1218–1236.
- ENDEAN, R., 1972, Aspects of molluscan pharmacology. In: FLORKIN, M. & SCHEER, B. T. (eds.), *Chemical Zoology*, Vol. 7, *Mollusca*. Academic Press, New York, p. 421–466.
- FEARE, C. J., 1971, The adaptive significance of aggregation behaviour in the dogwhelk *Nucella lapillus* (L.). *Oecologia*, 7: 117–126.
- FIRBY, J. B. & DURHAM, J. W., 1974, Molluscan radula from earliest Cambrian. *Journal of Paleontology*, 48: 1109–1119.
- FRANC, A., 1952, Notes écologiques et anatomiques sur *Tritonalia (Ocinebrina) aciculata* (Lk.) (Mollusque Prosobranch). *Bulletin du Laboratoire Maritime de Dinard*, 36: 31–34.
- FRANZ, D. R., 1977, Size and age-specific predation by *Lunatia heros* (Say, 1822) on the surf clam *Spisula solidissima* (Dillwyn, 1817) off western Long Island, New York. *Veliger*, 20: 144–150.
- FRETTER, V., 1941, The genital ducts of some British stenoglossan prosobranchs. *Journal of the Marine Biological Association of the United Kingdom*, 25: 173–211.
- FRETTER, V., 1946, The pedal sucker and anal gland of some British Stenoglossa. *Proceedings of the Malacological Society of London*, 27: 126–130.
- FRETTER, V. & GRAHAM, A., 1962, *British Prosobranch Molluscs, their Functional Anatomy and Ecology*. Ray Society, London, 755 p.
- GLUDE, J. B., 1956, Copper, a possible barrier to oyster drills. *Proceedings of the National Shellfisheries Association*, 47: 73–82.
- GRAHAM, A., 1941, The oesophagus of the stenoglossan prosobranchs. *Proceedings of the Royal Society of Edinburgh, section B (Biology)*, 61: 1–23.
- GRAHAM, A., 1973, The anatomical basis of function in the buccal mass of prosobranch and amphineuran molluscs. *Journal of Zoology*, 169: 317–348.
- GRÉGOIRE, C., 1972, Structure of the molluscan shell. In: FLORKIN, M. & SCHEER, B. T. (eds.), *Chemical Zoology*, Vol. 7, *Mollusca*, Academic Press, New York, p. 45–102.
- GUNTER, G., 1968, Some factors concerning the drilling apparatus and the feeding and predation of prosobranchiate gastropods especially on

- other molluscs. *Proceedings of Symposium on Mollusca*. Marine Biological Association, India, Bangalore Press, p. 370–378.
- GUNTER, G., 1979, Studies of the southern oyster borer, *Thais haemastoma*. *Gulf Research Reports*, 6: 249–260.
- HANCOCK, D. A., 1959, The biology and control of the American Whelk tingle *Urosalpinx cinerea* (Say) on English oyster beds. *Great Britain Ministry of Agriculture, Fisheries and Food, Fishery Investigations*, ser. 2, 22: 1–66.
- HANCOCK, D. A., 1969, Oyster pests and their control. *Great Britain Ministry of Agriculture, Fisheries and Food, Laboratory Leaflet*, new ser. no. 19, 30 p.
- HANKS, J. E., 1952, The effect of changes in water temperature and salinity on the feeding habits of the boring snails, *Polinices heros* and *Polinices duplicata*. *Fifth Report on Investigations of the Shellfisheries of Massachusetts, Massachusetts Division of Marine Fisheries*, p. 33–37.
- HANKS, J. E., 1953, A comparative study of the feeding habits of the boring snails, *Polinices heros* (Say) and *Polinices duplicata* (Say) as related to water temperature and salinity. *Master of Science Thesis, University of New Hampshire*, 57 p.
- HANKS, J. E., 1957, The rate of feeding of the common oyster drill, *Urosalpinx cinerea* (Say) at controlled water temperature. *Biological Bulletin*, 112: 330–335.
- HANKS, J. E., 1960, The early life history of the New England clam drills, *P. duplicatus* (Say), *P. heros* (Say), and *P. triseriata* (Say) (Naticidae; Gastropoda). *Doctoral Dissertation, University of New Hampshire*, 122 p.
- HEMINGWAY, G. T., 1973, Feeding in *Acanthina spirata* (Prosobranchia: Neogastropoda). *Master of Science Thesis, California State University, San Diego*, 85 p.
- HEMINGWAY, G. T., 1975a, Comparacion de la morfologia funcional de alimentacion en cuatro especies de perforadores marinos (Neogastropoda Muricacea). *Ciencias Marinas*, 2: 1–5.
- HEMINGWAY, G. T., 1975b, Functional morphology of feeding in the predatory whelk *Acanthina spirata* (Gastropoda Prosobranchia). *Bulletin of the American Malacological Union*, 41: 64–65.
- HEMINGWAY, G. T., 1978, Evidence for a paralytic venom in the intertidal snail *Acanthina spirata* (Neogastropoda: Thaisidae). *Comparative Biochemistry and Physiology*, 60C: 79–81.
- HUGUENIN, J. E., 1977, The reluctance of the oyster drill (*Urosalpinx cinerea*) to cross metallic copper. *Proceedings of the National Shellfisheries Association*, 67: 80–84.
- ISARANKURA, K. & RUNHAM, N. W., 1968, Studies on the replacement of the gastropod radula. *Malacologia*, 7: 71–91.
- JENSEN, A. S., 1951, Do the Naticidae (Gastropoda Prosobranchia) drill by chemical or mechanical means? *Videnskabelige Meddelelser fra Dansk naturhistorisk Forening*, 113: 251–261.
- KOHN, A. J., 1961, Chemoreception in gastropod molluscs. *American Zoologist*, 1: 291–308.
- KRUTAK, P. R., 1977, Gastropod radulae: their potential in the fossil record. *Transactions of the Gulf Coast Association of Geological Societies*, 27: 314–322.
- LARGEN, M. J., 1967, The diet of the dog-whelk, *Nucella lapillus* (Gastropoda: Prosobranchia). *Journal of Zoology*, 151: 123–127.
- MANSOUR-BEK, J. J., 1934, Über die proteolytischen Enzyme von *Murex anguliferus* Lamk. *Zeitschrift für vergleichende Physiologie*, 20: 343–369.
- MANZI, J. J., 1970, Combined effect of salinity and temperature on the feeding, reproductive, and survival rates of *Eupleura caudata* (Say) and *Urosalpinx cinerea* (Say) (Prosobranchia: Muricidae). *Biological Bulletin*, 138: 35–46.
- MARTOJA, M., 1971, Données histologiques sur les glandes salivares et oesophagiennes de *Thais lapillus* (L.) (= *Nucella lapillus*, Prosobranchie Néogastropode). *Archives de Zoologie Expérimentale et Générale*, 112: 249–291.
- MATSUKUMA, A., 1977, Notes on *Genkaimurex varicosa* (Kuroda, 1953) (Prosobranchia: Neogastropoda). *Venus, Japanese Journal of Malacology*, 36: 81–88.
- MCGRAW, K. A. & GUNTER, G., 1972, Observations on killing of the Virginia oyster by the Gulf oyster borer, *Thais haemastoma*, with evidence for a paralytic secretion. *Proceedings of the National Shellfisheries Association*, 62: 95–97.
- MEDCOF, J. C. & THURBER, L. W., 1958, Trial control of the greater clam drill (*Lunatia heros*) by manual collection. *Journal of the Fisheries Research Board of Canada*, 15: 1355–1369.
- MENGE, J. L., 1974, Prey selection and foraging period of the predacious rocky intertidal snail *Acanthina punctulata*. *Oecologia*, 34: 1–16.
- MORGAN, P. R., 1972, *Nucella lapillus* (L.) as a predator of edible cockles. *Journal of Experimental Marine Biology and Ecology*, 8: 45–52.
- NEWELL, P. F. & BROWN, A. C., 1977, The fine structure of the osphradium of *Bullia digitalis* Meuschen (Gastropoda, Prosobranchia). *Malacologia*, 16: 197–205.
- NIXON, M., 1979, Hole boring in shells by *Octopus vulgaris* in the Mediterranean. *Malacologia*, 18: 431–444.
- NIXON, M., in press, The salivary papilla of *Octopus* as an accessory radula for drilling shells. *Journal of Zoology*, 190:
- NYLEN, M. U., PROVENZA, D. V. & CARRIKER, M. R., 1968, Fine structure of the accessory boring organ of the gastropod *Urosalpinx*. *American Zoologist*, 8: 801–802.
- NYLEN, M. U., PROVENZA, D. V. & CARRIKER, M. R., 1969, Fine structure of the accessory boring organ of the gastropod *Urosalpinx*. *American Zoologist*, 9: 935–965.
- ORR, V., 1962, The drilling habit of *Capulus danieli* (Crosse) (Mollusca: Gastropoda). *Veliger*, 5: 63–67.
- PERSON, P. A., SMARSH, A., LIPSON, S. J. &

- CARRIKER, M. R., 1967, Enzymes of the accessory boring organ of the muricid gastropod *Urosalpinx cinerea follyensis*, 1. Aerobic and related oxidative systems. *Biological Bulletin*, 133: 401–410.
- PONDER, W. F., 1973, The origin and evolution of the Neogastropoda. *Malacologia*, 12: 295–338.
- PRATT, D. M., 1974a, Attraction to prey and stimulus to attack in the predatory gastropod *Urosalpinx cinerea*. *Marine Biology*, 27: 37–45.
- PRATT, D. M., 1974b, Behavioral defenses of *Crepidula fornicata* against attack by *Urosalpinx cinerea*. *Marine Biology*, 27: 47–49.
- PRATT, D. M., 1976, Intraspecific signalling of hunting success or failure in *Urosalpinx cinerea*. *Journal of Experimental Marine Biology and Ecology*, 21: 7–9.
- RADWIN, G. E. & WELLS, H. W., 1968, Comparative radular morphology and feeding habits of muricid gastropods from the Gulf of Mexico. *Bulletin of Marine Science*, 18: 72–85.
- RICHTER, G., 1962, Beobachtungen zum Beutefang der marinen Bohrschnecke *Lunatia nitida*. *Natur und Museum*, 92: 186–192.
- RITTSCHOF, D., 1980, Chemical attraction of hermit crabs and other attendants to simulated gastropod predation sites. *Journal of Chemical Ecology*, 6: 103–118.
- RITTSCHOF, D., in press, Enzymatic production of small molecules attracting hermit crabs to simulated gastropod predation sites. *Journal of Chemical Ecology*, 6:
- RUNHAM, N. W., 1969, The use of the scanning electron microscope in the study of the gastropod radula: the radulae of *Agriolimax reticulatus* and *Nucella lapillus*. *Malacologia*, 9: 179–185.
- RUNHAM, N. W., THORNTON, P. R., SHAW, D. A. & WAYTE, R. C., 1969, The mineralization and hardness of the radular teeth of the limpet *Patella vulgata* L. *Zeitschrift für Zellforschung*, 99: 608–626.
- SASSAMAN, C., 1974, Resource utilization function of boring gastropods. *American Zoologist*, 14: 1287.
- SOHL, N. F., 1969, The fossil record of shell boring by snails. *American Zoologist*, 9: 725–734.
- TAYLOR, J. D., MORRIS, N. J. & TAYLOR, C. N., 1980, Food specialization and the evolution of predatory prosobranch gastropods. *Palaeontology*, 23: 375–409.
- TRAVIS, D. G. & GONSALVES, M., 1969, Comparative ultrastructure and organization of the prismatic region of two bivalves and its possible relation to the chemical mechanism of boring. *American Zoologist*, 9: 635–661.
- WATABE, N. & WILBUR, K. M., 1976, *The Mechanisms of Mineralization in the Invertebrates and Plants*. University of South Carolina Press, Columbia, South Carolina, 461 p.
- WEBB, R. S. & SALEUDDIN, A. S. M., 1977, Role of enzymes in the mechanism of shell penetration by the muricid gastropod *Thais lapillus*. *Canadian Journal of Zoology*, 55: 1846–1857.
- WHITTAKER, V. P., 1960, Pharmacologically active choline esters in marine gastropods. *Annals of the New York Academy of Science*, 90: 695–705.
- WHITTAKER, V. P. & MICHAELSON, I. A., 1954, Studies on urocanylcholine. *Biological Bulletin*, 107: 304.
- WILBUR, K. M., 1972, Shell formation in mollusks. in FLORKIN, M. & SCHEER, B. T. (ed.), *Chemical Zoology*, vol. 7, *Mollusca*, Academic Press, New York, p.103–145.
- WILTSE, W. I., 1980, Predation by juvenile *Polinices duplicatus* (Say) on *Gemma gemma* (Totten). *Journal of Experimental Marine Biology and Ecology*, 42: 187–199.
- WOOD, L., 1968, Physiological and ecological aspects of prey selection by the marine gastropod *Urosalpinx cinerea* (Prosobranchia: Muricidae). *Malacologia*, 6: 267–320.
- WU, S.-K., 1965a, Comparative functional studies of the digestive system of the muricid gastropods *Drupa ricina* and *Morula granulata*. *Malacologia*, 3: 211–233.
- WU, S.-K., 1965b, Studies of the radulae of Taiwan muricid gastropods. *Bulletin of the Institute of Zoology, Academia Sinica*, 4: 95–106.
- YOUNG, D. K., 1969, *Okadaia elegans*, a tube-boring nudibranch mollusc from the central and west Pacific. *American Zoologist*, 9: 903–907.
- ZIEGELMEIER, E., 1954, Beobachtungen über den Nahrungserwerb bei der Naticidae *Lunatia nitida* Donovan (Gastropoda Prosobranchia). *Helgoländer wissenschaftliche Meeresuntersuchungen*, 5: 1–33.

## FUNCTIONAL MORPHOLOGY AND EVOLUTION OF THE TOXOGLOSSAN RADULA

Ronald L. Shimek and Alan J. Kohn

*Friday Harbor Laboratories and Department of Zoology,  
University of Washington, Seattle, Washington 98195, U.S.A.*

### ABSTRACT

Gastropods of the superfamily Toxoglossa have a chemically aided rapid-strike feeding method that immobilizes large prey animals; these are then swallowed whole. This report characterizes the major structural grades and functional types of the radula component of this mechanism and proposes a hypothesis of the evolutionary relationships of toxoglossan radulas. These probably evolved during the Cretaceous from the taenioglossan radula of a mesogastropod ancestor. Most of their major features are hypothesized to be simplifications from the taenioglossan condition: reduced number of rows of teeth, loss of one marginal tooth on each side, loss of the central and lateral teeth, and reduction of the radular membrane. The remaining marginal teeth have evolved in the directions of larger size and increased complexity; the most derived types function as hypodermic needles, injecting a virulent venom into the prey. Several lines of evidence support the proposed polarity of radula character states. A cladistic analysis of the subfamilies of Turridae using these data suggests that all major features of the toxoglossan radula evolved within the family Turridae; the radula has been less profoundly altered within the derivative families Conidae and Terebridae. The toxoglossan radula was an anatomical breakthrough that probably facilitated the rapid adaptive radiation of this superfamily in the Tertiary.

### INTRODUCTION

The toxoglossan gastropods have a rapid-strike, chemically aided feeding method that immobilizes and holds large prey animals that are then swallowed whole. Polychaete annelids are the usual prey organisms, but some members of the families Terebridae and Conidae eat enteropneusts and echiurans, some Turridae and Conidae eat other gastropods and sipunculans, and some conids are the only gastropods known to overpower and consume vertebrates (Kohn, 1959; Pearce, 1966; Miller, 1970; Kohn & Nybakken, 1975; Shimek, 1975, 1977; Bouchet & Warén, 1980; Nybakken, personal communication; Maes, personal communication).

The toxoglossan radular apparatus is a functionally innovative anatomical breakthrough that probably led to the occupation of new adaptive zones by this taxon as well as its remarkable adaptive radiation. The rates of diversification of the families of Toxoglossa are among the highest in the Mollusca (Stanley & Newman, 1980), and at the present time it is probably the largest prosobranch superfamily in number of species.

In this report, we first describe the functioning of the radula in Turridae in which feeding

has been directly observed, and we suggest the probable *modus operandi* of turrid radula types whose functioning has not yet been observed. We then hypothesize the evolutionary derivation of radula types within the Turridae and discuss the relationships of turrid radulas to those in other toxoglossan families. Finally we examine the degree to which a phenetic classification of turrid subfamilies based on radula characters is congruent with a classification based on shell morphometric characters. We employ the turrid subfamily classification of McLean (1971; McLean in Keen, 1971).

### FUNCTIONAL MORPHOLOGY OF TURRID RADULA TYPES

#### *Methods: Radula Preparation*

Radulas selected for scanning electron microscopy were obtained by removing the radular sac and placing it in 5% sodium hypochlorite. The radula was agitated periodically to aid the dissolution of tissues. When the tissue surrounding the radula was almost gone, the radula was transferred to distilled water and cleaned further by agitation. The radula was

then dehydrated in a series of alcohol rinses until it was in 70% ethanol. If a radular membrane was present, the preparation was completely dehydrated, dried in a critical point drier, and mounted on double-stick tape in preparation for plating. If there was no radular membrane, the individual teeth were further dehydrated to absolute ethanol, transferred to a 1:1 mixture of petroleum ether and absolute ethanol, allowed to air dry, and mounted individually on double-stick tape on an observation stub. The stubs were plated with gold-palladium in a vacuum evaporator and examined in a JEOL JSM-35 scanning electron microscope.

### Results

The feeding apparatus of the *Toxoglossa* consists of a venom apparatus, a specialized and unique proboscis (Robinson, 1960; Smith, 1967; Sheridan et al., 1973), and a highly derived radula. In all of the turrids considered here, a venom apparatus opens into the buccal cavity slightly posterior to the opening of the small and relatively immobile odontophore. The lack of acrembolic and pleurembolic proboscides preclude radular use as a boring or rasping organ. Instead the specialized intraembolic and/or polyembolic proboscis (Smith, 1967) assists in prey seizure. In those forms with detached hypodermic teeth, the proboscis functions to hold the tooth during envenomation. In all other forms, the proboscis probably functions to assist prey laceration by holding the prey in place. We have categorized turrid radula types in six groups, discussed below.

#### *The Slicing-Rasping Radula*

The slicing-rasping radula, apparently the most basic type in the Turridae, is found in the subfamilies Pseudomelatominae and Clavinae; however, the design is different in the two groups. The Clavinae contains several functional radular types, probably reflecting the variety of design possible with four or five radular teeth per row. For reasons given below, we consider this the most primitive condition in the extant Turridae. The slicing-rasping clavinate radula has five teeth per row (Fig. 1), a probably non-functional, reduced central tooth, a pair of curved, comb-like, interdigitating lateral teeth, and a pair of flattened, dagger-like marginal teeth. Lateral teeth do not occur in the radulas of any other turrid subfamily.

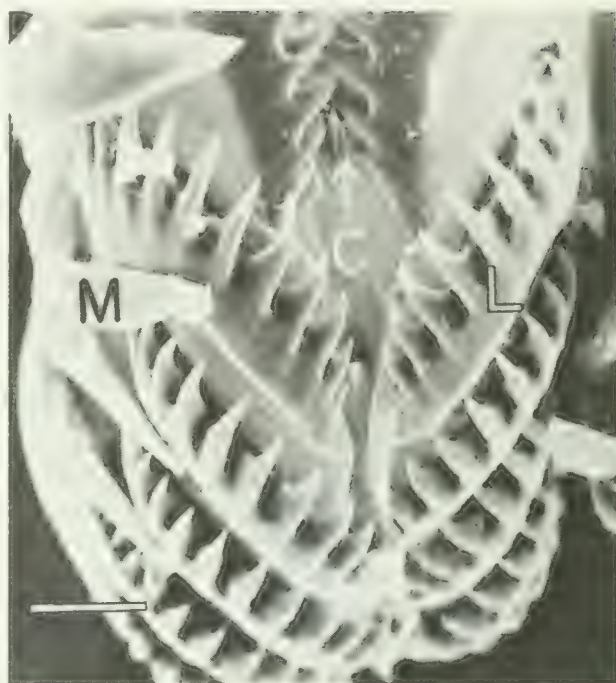

FIG. 1. *Calliclava albolaqueata* (Carpenter, 1865) subfamily Clavinae: slicing-rasping radula. Dorsal view of radula, bending plane to the bottom. C = central tooth. L = lateral tooth. M = marginal tooth. Scale bar = 20  $\mu\text{m}$ . Note interdigitation of posterior lateral teeth.

The lateral teeth are erected passing over the bending plane during radular protraction and extension. They probably lacerate the prey and may tear off fragments which are conveyed to the esophagus during radular retraction, assisted by the interdigitation of the cusps of the lateral teeth. The marginal teeth, erected as they cross the bending plane, would slice the prey during the action stroke. The marginal teeth are longer than the lateral teeth and would cut deeper into the prey, perhaps allowing for deeper venom penetration. If the venom contains lytic enzymes, further prey fragmentation would be facilitated.

The Pseudomelatominae also have a slicing-rasping radula, but of a fundamentally different design (Fig. 2A). Lateral teeth are absent. The central tooth is massive and unicuspid, functioning as a slicing tooth and a brace for the large scythe-like marginal teeth. The marginal teeth lacerate the prey, and they may tear off and convey fragments of the prey to the esophagus within the "basket" of teeth created as the radular ribbon passes over the bending plane (Fig. 2B).

#### *The Slicing Radula*

Three radular designs that are primarily slicers form the next functional grade. The



FIG. 2. *Tiariturris libya* (Dall, 1919) subfamily Pseudomelatominae: slicing-rasping radula. A. Dorsal view of the radula, bending plane to the top. B. Bending plane of the radula, antero-lateral view. C = central tooth. M = marginal tooth. Scale bars = 20  $\mu\text{m}$ .

first type, found only in the Clavinae (e.g. in *Agladrillia*, not illustrated) is a modification of the clavinate slicing-rasping radula described above. The small central tooth has been lost. The lateral teeth are curved and comb-like; however, their cusps do not interdigitate on the return stroke. The flattened marginal teeth have a lateral strengthening rib. Except that the lateral teeth do not interdigitate, and consequently cannot convey materials as efficiently into the esophagus, this radula functions much as the clavinate slicing-rasping radula.

The second slicing radular design is found in a large group of species in the subfamilies Turrinae (Fig. 3), Turriculinae (Figs. 3,4), Crassispirinae (Fig. 5), and Strictispirinae,

and is characterized by flattened rear-pointing marginal teeth. Originally these were probably shaped like flattened knife-like blades, but there are trends throughout these subfamilies toward the development of reinforcing ribs or struts. When the ribs are fully developed, the resulting tooth is of the so-called "duplex" type (Powell, 1942, 1966; Morrison, 1966; Maes, 1971; McLean, 1971). Examined with the light microscope, the struts often appear to be separate from the main blade of the tooth, and have been termed "accessory limbs." The accessory limb has been hypothesized to be the evolutionary remnant of the missing taenioglossan marginal tooth (Maes, 1971). Fig. 4 shows the *de novo* origin of the accessory limb from a fold in the developing marginal tooth. The marginal teeth in this type of

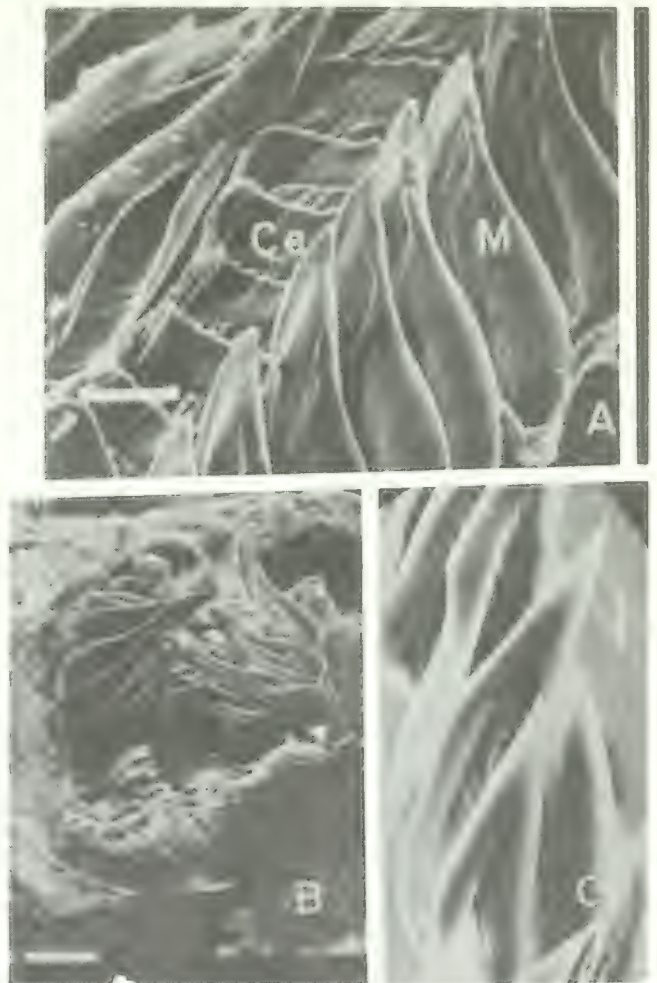

FIG. 3. *Aforia circinata* (Dall, 1919) subfamily Turriculinae: slicing radula. A. Dorso-lateral view of the radula, bending plane to the top. Ce = central tooth. M = marginal tooth. Scale bar = 25  $\mu\text{m}$ . B. Bending plane of the radula in the buccal cavity, frontal view. Note orientation of teeth as they cross the bending plane. Scale bar = 100  $\mu\text{m}$ . C. *Polystira picta* (Reeve, 1843) subfamily Turrinae: slicing radula. One half radula. Note the accessory limbs of the teeth. Scale bar = 5  $\mu\text{m}$ .

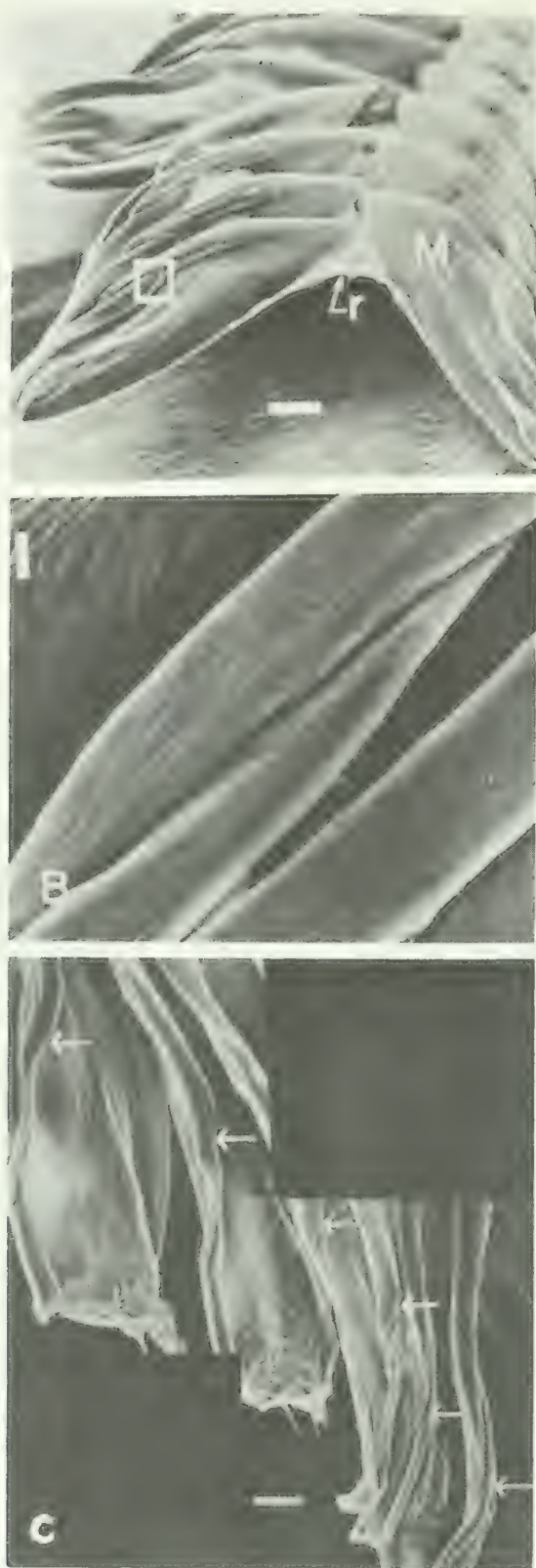

FIG. 4. *Knefastia dalli* (Bartsch, 1944) subfamily Turriculinae: slicing radula. A. Frontal view of radula. M = marginal tooth. r = radular ribbon. Note strengthening strut or accessory limb. Scale bar = 50  $\mu\text{m}$ . B. Dorsal aspect of area shown in square in A, anterior to top. Note that there is no suture line. Scale = 5  $\mu\text{m}$ . C. Dorsal view of immature radular teeth of the same radula; sequence from younger (top left) to older teeth. Arrows indicate area of tooth shown in B. Teeth at this stage are flexible. Note that the fold indicated by the arrows in C develops into the accessory limb of the more mature teeth in A and B. Scale bar = 25  $\mu\text{m}$ .



FIG. 5. *Crassispira rudis* (Sowerby, 1834) subfamily Crassispirinae: slicing radula. A. Dorsal view, one half radula. Arrow indicates strengthening strut or accessory limb. B. Immature teeth of the same radula. Note accessory limbs developing from a fold in the tooth material, younger teeth to the top. Scale bars = 20  $\mu\text{m}$ .

radula, erected as they cross the bending plane, function as slicing blades during the effective stroke. The substantial stress on these long, relatively thin, erect teeth could be countered in several ways. The side of the tooth opposite the cutting edge can be thickened or supported by a strengthening fold, or both lateral edges can be thickened with the cutting function relegated to the tooth tip. The central tooth, when present, may or may not retain a small slicing cusp, but it probably functions primarily to brace the marginal teeth during their slicing stroke. The central tooth is lost in many species within this grade, pre-



sumably in response to simplifying selective pressures acting upon the radula as the internal bracing of the marginal teeth becomes more efficient. Additionally, this radular structural grade is probably polyphyletic; some lineages may have developed from clavinate ancestors lacking the central tooth.

The final development of the purely slicing radula, seen in some of the Crassispirinae, is the development of the supporting rib to give the marginal tooth a prominent free lateral brace (Fig. 6). As with the previous radular type, the erected marginal teeth function as slicing agents, but with the development of

the "flying buttress" the slicing portion of the tooth is thinner and presumably more effective. A bracing central tooth is absent.

#### *The Slicing-Stabbing Radula*

A further modification of the basic slicing radula is found in some Clavinae. Here the lateral teeth are curved and comb-like with short, non-interdigitating cusps, and when the teeth are erected as they cross the bending plane they function to lacerate the prey. There is no central tooth. The marginal teeth, unlike other clavinate marginal teeth, however, are barbed and rolled to form a central channel (Fig. 7). In addition to forming an efficient lacerating organ as they cross the bending plane, the rolled tooth could facilitate envenomation of the prey. The length and rearward orientation of the marginal teeth would also help force the prey farther into the esophagus with each return stroke of the radula.

#### *The Stabbing Radula*

The radula of the Zonulispirinae is a derivation of the slicing-stabbing radula seen in the Clavinae (Fig. 8). The lateral teeth have been lost, but the rolled, hollow, often barbed, marginal teeth remain attached to a strong radular membrane. These teeth probably function to pierce the prey, introducing venom on the radular action stroke. On the recovery stroke, they probably fold rearward, forcing prey into the esophagus. As the edges of the marginal overlap less than  $\frac{3}{4}$  of the total tooth length, it is probably not an efficient hypodermic injector for thick-skinned prey.

In all of the above turrid radulas with a functional radular membrane, the rearward moving radular teeth on the return stroke of the radula probably tend to act as a ratchet, forcing prey into the esophagus. Indeed, due to the small size of the radula, the laceration function of the radula might be minimal, and the major functions of radular action may be envenomation through the wounds created, and the assistance of swallowing.

#### *The Hypodermic Radula with Reduced Membrane*

Rolled hollow marginal teeth, overlapped for  $\frac{3}{4}$  of their length or more, are found in the Clathurellinae and Daphnellinae (Fig. 9). Sim-

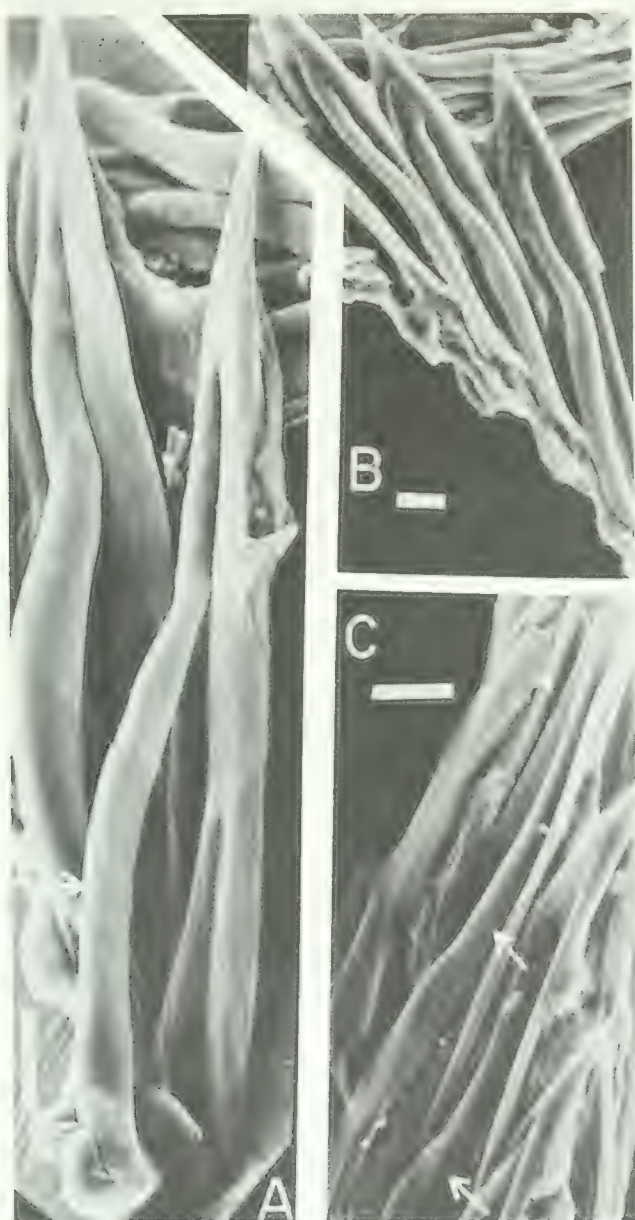

FIG. 6. *Hindsiclava militaris* (Reeve, 1843) subfamily Crassispirinae: slicing radula. A. "Wishbone" or flying buttress marginal tooth, lateral view. Arrow indicates the strengthening strut. B. Dorsal aspect of radula. C. Immature teeth of the same radula as in A, arrows indicate developing strut from a fold in the tooth material. All scale bars = 10  $\mu$ m.

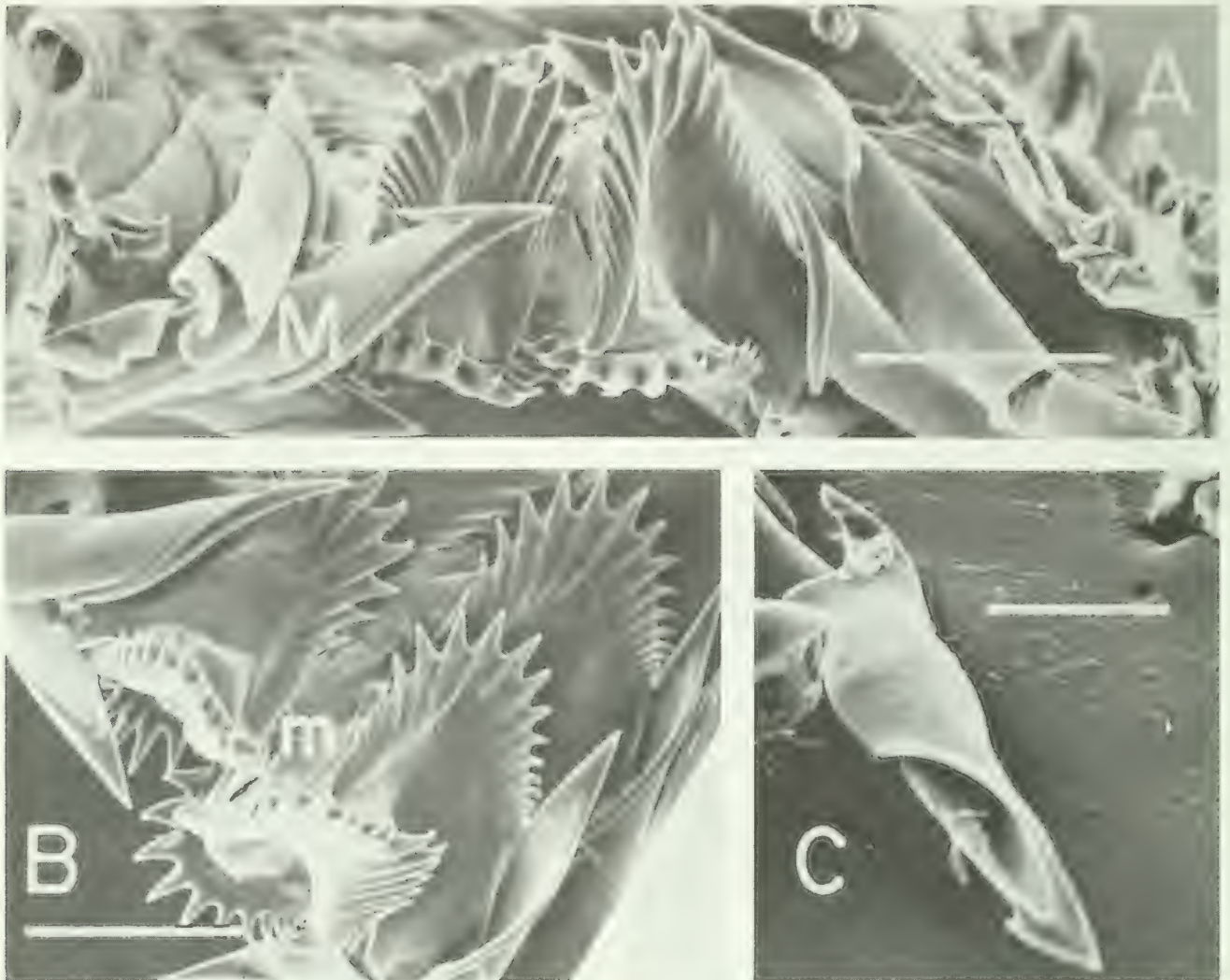

FIG. 7. *Imaclava unimaculata* (Sowerby, 1834) subfamily Clavinae: slicing-stabbing radula. A. Anterior view of broken radular ribbon. L = lateral tooth. M = marginal tooth. Note coiled nature of the broken marginal teeth. Scale bar = 100  $\mu\text{m}$ . B. Dorsal view of the bending plane of the radula. m = radular membrane. Note orientation shift of the marginal teeth as they cross the bending plane. Scale bar = 100  $\mu\text{m}$ . C. Isolated marginal tooth, note central channel and barb. Scale bar = 50  $\mu\text{m}$ .

ilar to, and presumably derived from the stabbing radular type described above, here the radular membrane is reduced and appears too weak to hold the tooth during active radular movement. Instead, the teeth are probably sloughed off the end of the membrane, charged with venom, and used individually as hypodermic needles, held either in the true mouth or the tip of the extensible proboscis.

#### *The Hypodermic Radula with Vestigial Membrane*

The radular membrane is further reduced in the final two radular types. As in the above two types, only marginal teeth remain. In the first of these, found only in some Mangeliinae, the teeth are rolled on themselves to form an open channel (Fig. 10). This is the "hilted dagger" tooth of Powell (1942, 1966). The

teeth are sloughed off the end of the radular membrane, stored in the short arm of the radular sac, and used individually as hypodermic venom injectors. These teeth often have a prominent spur at the base which presumably aids the proboscis in gripping the tooth. Venom flows into the prey through the channel, which may be closed dorsally by the proboscis or forced shut by the pressure of the gripping proboscis.

The second type of radular design with a vestigial membrane is also found in the Mangeliinae (Fig. 11), but additionally in the Mitrolumninae, the Borsoniinae (Fig. 12), and the Conidae. Here the marginal teeth are tubular, but the degree of overlap varies considerably, particularly within the Mangeliinae. In *Oenopota* it ranges at least from 25% to 85% of the length of the tooth (Fig. 11); it is less than 50% in most species. In the other



FIG. 8. *Compsodrillia duplicata* (Sowerby, 1834) subfamily Zonulispirinae: stabbing radula. Dorsal view of the radula, membrane is torn. Arrow indicates barb on the marginal tooth. Note amount of overlap of edges of teeth. Scale bar = 25  $\mu\text{m}$ .



FIG. 9. *Gymnobela* sp. Subfamily Daphnellinae: hypodermic radula with reduced radular membrane. Mature radular teeth sloughed from membrane are on the left. Arrow indicates immature teeth still fastened to the radular membrane on the right. The teeth lack barbs, which are found on the teeth of some other species of *Gymnobela*. Scale bar = 10  $\mu\text{m}$ .



FIG. 10. *Kurtziella plumbea* (Hinds, 1843) subfamily Mangeliinae: hypodermic radula with vestigial radular membrane. A, C. Immature teeth, lateral and dorso-lateral views, respectively. Note channel or groove in tooth, and the lack of a radular membrane. s = spur. B. Mature teeth, seen from the opposite lateral aspect from those in A and C. Note hole in the tip of the tooth and the strong elongate base of the tooth. Scale bars = 10  $\mu\text{m}$ .

subfamilies the overlap region exceeds 75% of the tooth length. Teeth of this type are sometimes barbed, but they lack the large basal spur of the first type. The teeth are individually held in the proboscis and stabbed into the prey (Fig. 13) introducing venom. Barbs on the teeth often hold the prey during ingestion.

#### ORIGIN OF THE TOXOGLOSSAN FEEDING MECHANISM

The prey-capturing component of the toxoglossan feeding mechanism probably evolved during the Mesozoic from a mesogastropodan precursor in one of two ways:

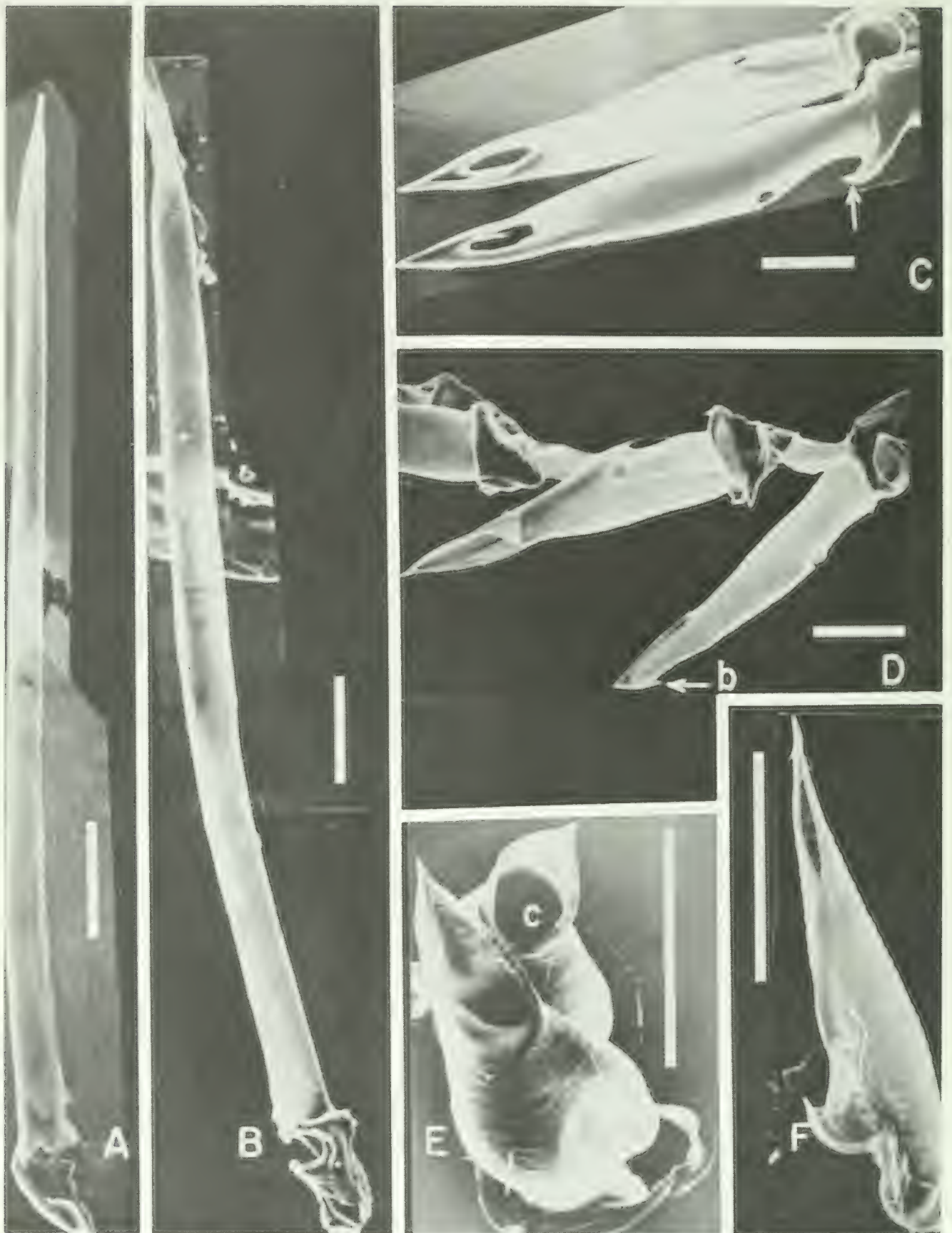

FIG. 11. *Oenopota* spp. Subfamily Mangelinae: Hypodermic radula with vestigial membrane. A. *O. simplex* (Middendorff, 1849). B. *O. fidicula* (Gould, 1849). C. *O. turricula* (Montagu, 1803). Arrow indicates spur. Note degree of overlap of edges of tooth and cantilevered strut supporting tip of tooth. Lower tooth is rotated 90° to the left of upper one. D, E. *O. rugulata* (Troschel, 1866). Lateral and apical views. b = apical barb. c = central channel. F. *O. tabulata* (Carpenter, 1864). Note apical barb, basal spur, amount of overlap, and surface texture. All scale bars = 50  $\mu$ m.



FIG. 12. Subfamily Borsoniinae: hypodermic radula with vestigial radular membrane. A. *Ophiidermella inermis* (Hinds, 1843). Compare with Fig. 11 A,B. Note difference in blade (bl) orientation, basal structure, and the presence of a remnant of the connection to the radular membrane. Compare also with Fig. 9. Scale bar = 50  $\mu\text{m}$ . B-D. *Suavodrillia kennicottii* (Dall, 1871). B. Lateral view, bl = blade. C. Fractured tooth. Note coiled structure. D. As in C showing flared base of tooth. Scale bars: B = 50  $\mu\text{m}$ . C and D = 10  $\mu\text{m}$ .

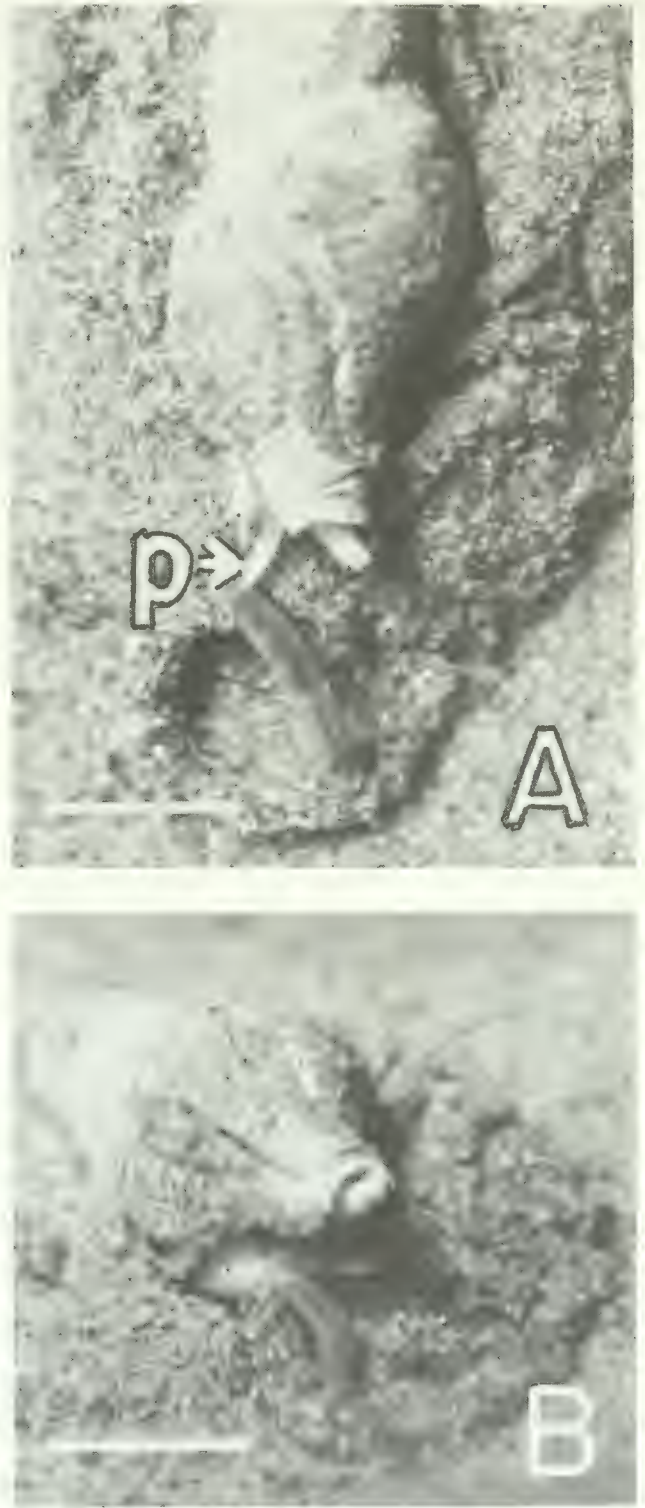

FIG. 13. *Ophiidermella inermis* (Hinds, 1843) A. Attacking prey organism, *Owenia fusiformis* delle Chiaje, 1844. Tooth is held in the tip of the intra-embolic proboscis (p), and forced into the prey. B. Ingestion of the prey by the snail. Scale bars = 1 cm.

1, from a taenioglossan (2-1-R-1-2) ancestor, or

2, from a "reduced rhipidoglossan" (1-1-R-1-1) ancestor (Ponder, 1973). According to hypothesis 1, loss of one marginal tooth on each side is an initial apomorphy of the *Toxoglossa*. Although Maes (1971) proposed that the single marginal tooth evolved within the *Toxoglossa* by fusion of the two marginals on each side, our evidence cited above (Fig. 4) makes this unlikely. According to hypothesis 2, reduction of the central tooth is the most likely initial apomorphy of the *Toxoglossa*.

Both hypotheses consider the major evolutionary trends to involve 1) structural simplification by reduction in number of teeth per row, 2) enlargement and elaboration of the remaining pair of marginal teeth, and 3) reduction of the radular membrane. The difference between hypotheses 1 and 2 would disappear if the "reduced rhipidoglossan" ancestor of hypothesis 2 were phylogenetically intermediate between the *Taenioglossa* and *Toxoglossa*. However, if it is considered as ancestral to both taxa, then the *Taenioglossa* have added a second marginal tooth on each side (Ponder, 1973). The following lines of evidence tend to support hypothesis 1 and the polarity of the three major evolutionary trends listed above:

1. *Commonality of primitive state.* According to the commonality principle, "a character state widespread within a group is likely to be primitive for that group" (Eldredge, 1979). The taenioglossan radula formula occurs in all families belonging to the 12 of 13 mesogastropodan superfamilies in which a radula is present (Thiele, 1929; Fretter & Graham, 1962; Morton, 1979).

2. *Limited distribution of derived state.* Derived states are expected to have more limited distributions, resulting in the patterns of special resemblance (Eldredge, 1979). If the taenioglossan formula is considered primitive, derived states are found in the three neogastropodan superfamilies (Ponder, 1973). In addition, the limited distribution of some similar radula patterns within mesogastropodan families (e.g. *Lamellariidae*; Behrens, 1980) provides additional supporting evidence.

3. *Stratigraphic distribution of taxa.* The argument for polarity of primitive and derived states is strengthened if stratigraphic ranges conform. While the evidence is strongest for taxa whose stratigraphic ranges do not overlap, this strength is not available, because

radula formulas can be known only from extant representatives of the taxa in question. The Mesogastropoda are known from Ordovician time, were widespread throughout the Paleozoic, and at least three extant superfamilies have Paleozoic representatives (Cox, 1960). The Neogastropoda probably arose during the Mesozoic (from the superfamily *Subulitacea* in Ponder's (1973) view); the *Toxoglossa* as well as other neogastropodan superfamilies are known from the early Cretaceous (Ponder, 1973; Sohl, 1977).

#### CLADISTIC ANALYSIS OF THE TOXOGLOSSAN RADULA

In view of the preceding arguments, we conclude that the taenioglossan radula contains the maximum number of four primitive character states (Table 1) and thus serves as the 'ground plan' (Wagner, 1969) for the cladistic divergence analysis that follows.

The cladogram (Fig. 14) was constructed by the Camin-Sokal monothetic method (Sneath & Sokal, 1973: 336f). The operational taxonomic units (OTUs) are the *Taenioglossa* and 13 taxa of *Turridae* at the subfamily and genus levels. For this analysis we consider the series of taxa represented by these OTUs monophyletic from the first branch point. The classification and radula data are based on McLean (1971), modified by original scanning electron microscopy studies by the first author; the latter are the basis for subdividing 3 subfamilies. The cladogram shows the transformations relating observed traits to shared, derived character states. Postulated evolutionary changes are indicated by crossbars numbered to agree with the transitions indicated in Table 1.

The alignment of taxa in the cladogram is generally consistent with the functional groupings described in the previous section. The main differences are the position of *Imaclava*, whose slicing-stabbing radula combines the intermediate character state of channeled marginal teeth with the primitive retention of lateral teeth, and of *Kurtziella*, whose hypodermic radula combines channeled marginal teeth with the most derived states of the other three characters.

Available evidence of stratigraphic distribution of turrid subfamilies is also consistent with the cladistic relationships shown in Fig. 14. All 30 species of *Turridae* of the well studied Lower Oligocene Keasey Formation

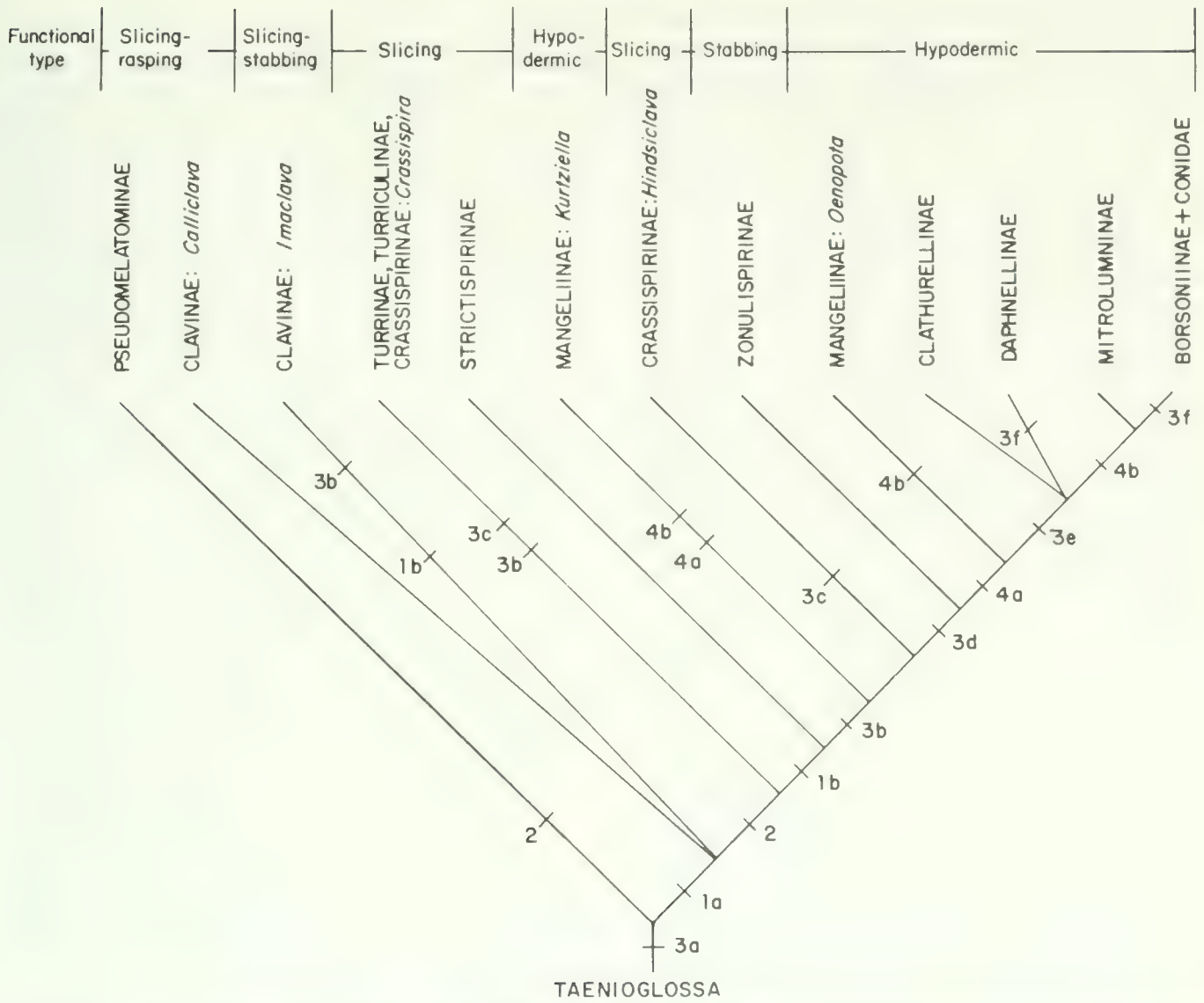

FIG. 14. Cladogram of radula characteristics of the Taenioglossa, subfamilies and certain genera of Turridae, and Conidae, constructed by the monothetic method. The cladogram relates the evolutionary transformations, designated as in Table 1, that relate observed traits to shared, derived characters. Evolutionary steps representing different states of the same character are grouped closely; otherwise the position of steps on the branches has no significance.

TABLE 1. Cladistic analysis of toxoglossan radula characters: polarity of character states. Evolutionary transformations are numbered in parentheses.

Character	States		
	Primitive		Derived
1. CENTRAL TOOTH	Large	Small (1a)	Absent (1b)
2. LATERAL TOOTH	Present	Absent (2)	
3. MARGINAL TEETH	2 Present	1 Solid (3a)	1 Channeled (3b)
			1 Hollow, overlapped < 3/4 length, (3c)
			1 Hollow, overlapped > 3/4 length, not barbed (3d)
		1 Hollow, overlapped > 3/4 length, barbed (3e)	1 Hollow, overlapped > 3/4 length, barbed (3f)
4. RADULAR MEMBRANE	Strong	Weak (4a)	Vestigial (4b)

in Oregon belong to the subfamilies Turrinae, Clavinae, and Turriculinae. These three subfamilies comprise only 35% of the Recent turrid species in similar Eastern Pacific habitats, where the Daphnellinae (42%) and Borsoniinae (17%) are also major components (Hickman, 1976).

Figure 14 suggests that all major features of toxoglossan radula evolution, shown in Table 1, occurred within the family Turridae. The most derived turrid radulas are of the hypodermic type, consisting only of long, hollow, barbed marginal teeth with a vestigial membrane. These characterize the subfamily Borsoniinae, which share all of these character states with the Conidae. More profound evolutionary transformations of the radula occurred within the Turridae than between the Taenioglossa and Turridae or between the Turridae and Conidae. Radula morphology varies considerably in the third major family of Toxoglossa, the Terebridae, but this family has as yet been the subject of even less comparative study than the Turridae and Conidae, and we can shed little light on phylogenetic patterns. Rudman (1969) established a new family for the genus *Pervicacia*, in which each radular row consists only of a pair of solid, flattened, pointed marginal teeth supported by a strong radular ribbon, thus resembling the radula of the turrid subfamily Strictispirinae. Troschel (1866) had described a similar radula but with more complex teeth in *Myurella*, generally considered a subgenus of *Terebra* (Thiele, 1929). In the terebrid genus *Hastula* and in some species of *Terebra* s.s., the radula teeth share all the derived character states indicated above in the Borsoniinae and Conidae (Troschel, 1866; Miller, 1980; Mills, 1977).

Finally, some members of at least two toxoglossan families completely lack a radula. This is the case in *Cenodagreutes* (Turridae: Smith, 1967) and in a number of species of *Terebra* (Rudman, 1969; Troschel, 1866). No *Conus* without a radula is known, but the radular apparatus is extremely small and likely vestigial in *C. leopardus*, which engulfs prey organisms without stinging them (Kohn, 1959).

#### RELATION OF TOXOGLOSSAN RADULA CHARACTERS AND SHELL FORM

If one classifies the Toxoglossa according to cladistic relationships of radula character-

istics, is this classification congruent with one based on shells? If this were so, both character sets could be used to develop a hypothesis of phylogenetic relationships. Classifications of gastropods are of course based predominantly on shell form. Shell characters are more accessible and more easily studied than radulas, and shells are durable and available in the fossil record. A classification based primarily on radula characters has the major drawback of being unable to deal with the fossil record (Hickman, 1976).

The hallmark of the turrid shell is the anal sinus, but at the present time we have no independent assessment of polarity of trends in shell form within this family. In the very preliminary analysis that follows, we therefore present only a phenetic classification derived from objective expression of shell shape using 5 basic parameters of the coiled shell applicable to turrids: shape of the generating curve (S), rate of translation (T), rate of spire translation (ST), rate of whorl expansion (W), and relative whorl height (RWH) (Raup, 1966; Kohn & Riggs, 1975). We measured these for one species in each genus listed separately in Fig. 14 and averaged values for three species representing different genera in each subfamily. Measurements are based on illustrations in Keen (1971) selected for suitability for morphometric analysis. For the one genus not illustrated by Keen, we used shells of *Oenopota elegans* from Friday Harbor, Washington. The phenogram (Fig. 15A) was constructed by the unweighted pair-group method using arithmetic averages (UPGMA) of Euclidean distances (Sneath & Sokal, 1973).

Two parameters, T and S, account for most of the groupings of OTUs: The Turrinae and *Hindsiclava* have very high values of T; the Pseudomelatominae, Turriculinae, other Crassispirinae, Borsoniinae and Zonulispirinae have rather high T and S values; the Mitrolumninae has very high S and rather high T values; and the Clavinae, Strictispirinae, Daphnellinae, Clathurellinae, and Mangeliinae have lower values of T. In order to avoid introducing a variable in addition to general aperture shape, we omitted from consideration species in which high values of S were due to anterior elongation of the aperture into a shell siphon. The distinct separation of the Turrinae in the phenogram (Fig. 15A) is consistent with a classification based primarily on position of the anal sinus (Hickman, 1976). Unfortunately, reliance on pub-



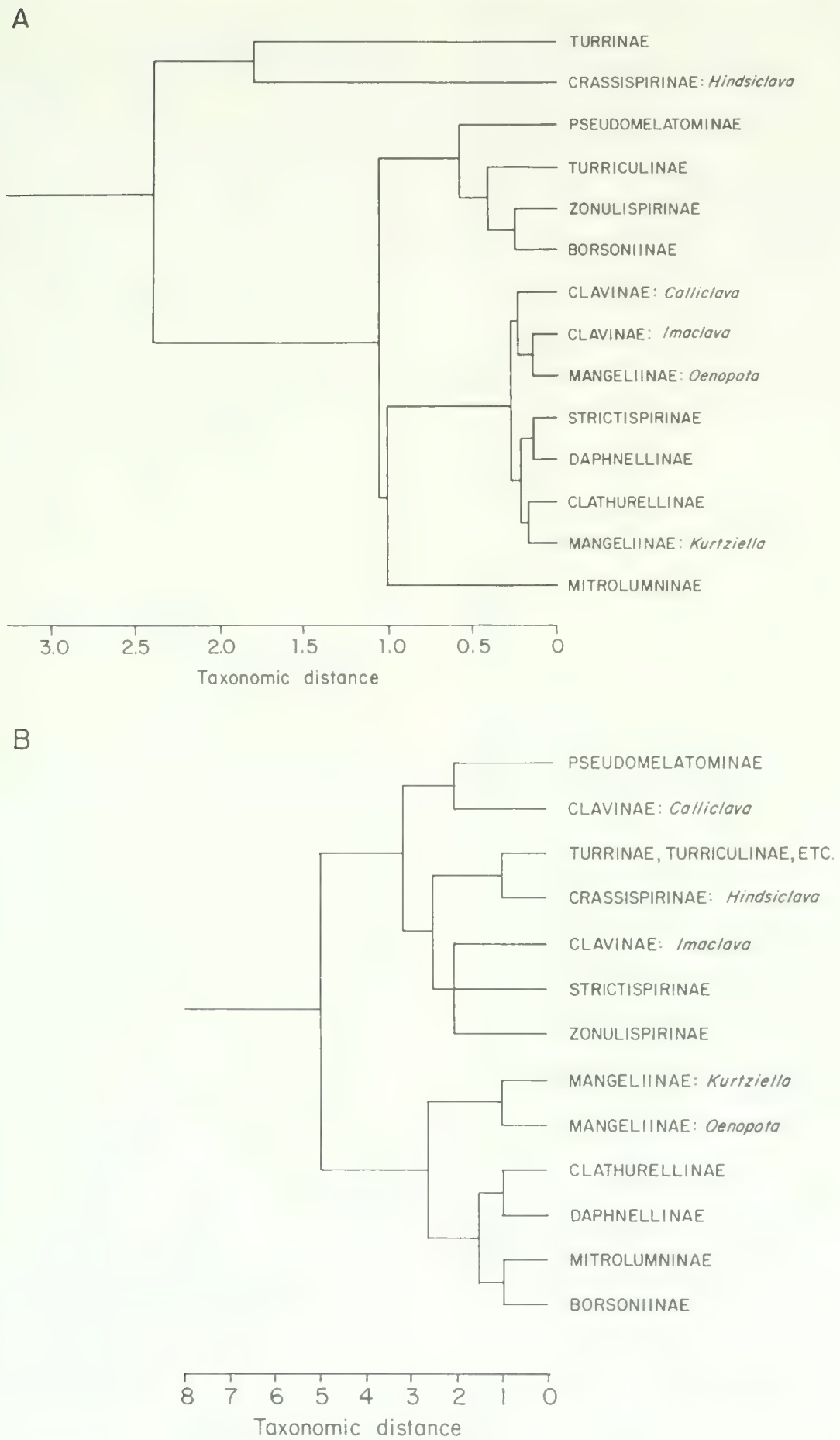

FIG. 15. Phenograms of subfamilies and certain genera of Turridae based on UPGMA cluster analysis of taxonomic distance measures: A, 4 multistate radula characters; cophenetic correlation coefficient = 0.74; B, 5 quantitative shell geometry characters; cophenetic correlation coefficient = 0.88. In B, taxa have been rotated about axes to maximize conformance with A.

lished ventral views precluded our use of this and the other quantitative shell characters presented by Hickman (1976).

In order to facilitate direct comparison with the phenogram based on shell characters (Fig. 15A), the cladistic relationship of turrid radula characters was converted into a phenogram of the same character states (Fig. 15B) by measuring taxonomic distance as the number of differences between OTUs in Fig. 14. The correlation coefficient between the taxonomic distance matrices of shell and radula characteristics is only 0.02. The preliminary analysis thus does not indicate congruence between the classification based on the phenetic similarities of the two character sets.

## DISCUSSION

The *Toxoglossa* first appear in the fossil record in the Lower Cretaceous; they probably arose from a mesogastropod ancestor. The toxoglossan radular apparatus probably evolved from the taenioglossan radula. In applying the cladistic method to phylogeny of the *Toxoglossa*, we identified apomorphic character states shared by the derived subfamilies of the Turridae, as well as by the Terebridae and Conidae.

The maximum number of radular teeth per row in the *Toxoglossa* is 5: one pair of marginal teeth, a pair of lateral teeth, and a central tooth. This condition is found only in some genera of the subfamily Clavinae of the family Turridae. The most derived radular character states are: 1) loss of the central tooth, 2) loss of the lateral teeth, 3) elongation and rolling of the marginal tooth into a sharp-pointed hollow tube bearing barbs, and 4) a vestigial radular membrane. Three lines of evidence, based on commonality of the primitive states, limited distribution of the derived states, and correspondence with the stratigraphic distribution of taxa, support this interpretation of the polarity of character states, from the primitive condition shown in Table 1. If this interpretation is correct, the main trends of toxoglossan radular evolution occurred within the Turridae and involved primarily "streamlining" (Regal, 1977) or simplification: reductions in the number of teeth per row, number of rows of teeth, and importance of the radular membrane. Concomitantly the main evolutionary elaboration involved the marginal teeth and included increased size and complexity.

The set of shared, derived radula character states we employ thus includes states with both rather low and high information content (Hecht & Edwards, 1976). The central and lateral teeth and the radular membrane provide less information because the derived states result from the reduction and loss of more complex structures. The marginal teeth provide the most important type of information, because they are "shared and derived character states which are unique and innovative in structure" (Hecht & Edwards, 1976).

In the most primitive turrid genera (subfamily Clavinae), the radula probably retains a rasping function, but the marginal teeth probably slice or lacerate the prey. Loss of the lateral and central teeth led to the slicing and stabbing radulas employing only the one elaborated marginal tooth on each side of the radular row. The elongate, hypodermic marginal tooth is regarded as the most derived toxoglossan radula type. The major selective pressure in the direction of such large, hollow, pointed and barbed marginal teeth appears to have been selection for increased efficiency of envenomation of prey. As the primitive turrid radula was probably not within an extensible proboscis, selection toward specialization for rasping or boring probably would not have been effective.

The shape of the rolled marginals varies considerably and it is likely that this structural grade has been arrived at through at least two different pathways. The first pathway from the pre-adapted rolled marginal teeth of the slicing-stabbing radula of the Clavinae to the true toxoglossan hypodermic radula of the Borsoniinae and Conidae would involve several intermediate structural grades. Three major evolutionary events characterize this pathway: first, development of the rolled marginal teeth of the slicing-stabbing radula with a strong radular membrane; second, loss of the lateral teeth with retention of the strong radular membrane; third, gradual reduction of the radular membrane to a vestigial ligament attached to the base of the tooth. The presence in living animals of many, if not all, intermediate forms provides supportive evidence for this sequence of events. The second pathway would involve the grooving, rolling, and subsequent overlapping of a blade-like, cutting marginal tooth. This pathway is characterized by the development of grooved marginals probably in the slicing radula lineage of the Turrinae-Turriculinae complex. The complete loss of the radular

membrane and the sequence from grooved to barely overlapped to completely rolled marginal teeth is found in the Mangeliinae. Cladistic analysis of radular features is consistent with the argument that the true toxoglossan condition evolved at least twice by indicating that the events leading to the toxoglossate condition could have occurred in several different turrid subfamilies.

Because there has been no prior attempt to assess the relationships of the subfamilies of Turridae, we compared phenograms based on radular and shell morphometry characters. Although there was no correlation, analyses of additional taxa and character sets might lead to a higher degree of congruence.

While this study must be considered an initial and preliminary approach to the evolution of the toxoglossan feeding mechanism and to the phylogeny of this superfamily, the objective methods employed introduce testable procedures to the study of evolutionary relationships of gastropod taxa, an area long dominated by more subjective judgments.

#### ACKNOWLEDGMENTS

We thank E. N. Kozloff, Acting Director, for providing research facilities at the Friday Harbor Laboratories, T. E. Schroeder for much assistance with scanning electron microscopy, and P. A. Raymore and M. A. Rex for providing specimens used in this study. We are grateful to R. S. Houbriek and J. H. McLean for critically reviewing the manuscript. This research was partially supported by NSF Grant DEB 77-24430.

#### LITERATURE CITED

- BEHRENS, D. W., 1980, The Lamellariidae of the North Eastern Pacific. *Veliger*, 22: 323-339.
- BOUCHET, P. & WARÉN, A., 1980, Revision of the North-East Atlantic bathyal and abyssal Turridae (Mollusca, Gastropoda). *Journal of Molluscan Studies Supplement* 8: 119 p.
- COX, L. R., 1960, Gastropoda: General characteristics of Gastropoda. In MOORE, R. C. (ed.), *Treatise on Invertebrate Paleontology*, Part I, Mollusca 1. Geological Society of America and University of Kansas Press, Lawrence, p. 185-1169.
- ELDREDGE, N., 1979, Cladism and common sense. In CRACRAFT, J. & ELDREDGE, N. (eds.), *Phylogenetic analysis and paleontology*. Columbia University Press, New York, p. 165-198.
- FRETTER, V. & GRAHAM, A., 1962, *British proso-branch molluscs*. Ray Society, London, 755 p.
- HECHT, M. K. & EDWARDS, J. L., 1976, The determination of parallel or monophyletic relationships: the proteid salamanders. *American Naturalist*, 110: 653-677.
- HICKMAN, C. S., 1976, Bathyal gastropods of the family Turridae in the early Oligocene Keasey Formation in Oregon, with a review of some deep-water genera in the Paleogene of the Eastern Pacific. *Bulletins of American Paleontology*, 70: 119 p.
- KEEN, A. M., 1971, *Sea shells of tropical West America*. Stanford University Press, Stanford, California, 1064 p.
- KOHN, A. J., 1959, The ecology of *Conus* in Hawaii. *Ecological Monographs*, 29: 47-90.
- KOHN, A. J. & NYBAKKEN, J. W., 1975, Ecology of *Conus* on eastern Indian Ocean fringing reefs: Diversity of species and resource utilization. *Marine Biology*, 29: 211-234.
- KOHN, A. J. & RIGGS, A. C., 1975, Morphometry of the *Conus* shell. *Systematic Zoology*, 24: 346-359.
- MAES, V., 1971, Evolution of the toxoglossate radula and methods of envenomation. *American Malacological Union Annual Reports for 1970*, p. 69-72.
- MCLEAN, J. H., 1971, A revised classification of the family Turridae, with the proposal of new subfamilies, genera, and subgenera from the eastern Pacific. *Veliger*, 14: 114-130.
- MILLER, B. A., 1970, *Studies on the biology of Indo-Pacific Terebridae*. Ph.D. dissertation, University of New Hampshire, 213 p.
- MILLER, B. A., 1980, The biology of *Hastula inconstans* (Hinds, 1844) and a discussion of life history similarities among other *Hastulas* of similar proboscis type. *Pacific Science*, 33: 289-306.
- MILLS, P. M., 1977, Radular tooth structure in three species of Terebridae. *Veliger*, 19: 259-265.
- MORRISON, J. P. E., 1966, On the families of Turridae. *American Malacological Union Annual Reports for 1965*, p. 1-2.
- MORTON, J. E., 1979, *Molluscs*. Hutchinson, London, 264 p.
- PEARCE, J. B., 1966, On *Lora trevelliiana* (Turton) (Gastropoda: Turridae). *Ophelia*, 3: 81-91.
- PONDER, W. F., 1973, The origin and evolution of the Neogastropoda. *Malacologia*, 12: 295-338.
- POWELL, A. W. B., 1942, The New Zealand Recent and fossil Mollusca of the family Turridae, with general notes on turrid nomenclature and systematics. *Bulletin of the Auckland Institute and Museum*, no. 2, 188 p.
- POWELL, A. W. B., 1966, The molluscan families Speightiidae and Turridae. *Bulletin of the Auckland Institute and Museum*, no. 5, 184 p.
- RAUP, D. M., 1966, Geometric analysis of shell coiling: general problems. *Journal of Paleontology*, 40: 1178-1190.

- REGAL, P. J., 1977, Evolutionary loss of useless features: is it molecular noise suppression? *American Naturalist*, 111: 123-133.
- ROBINSON, E., 1960, Observation on the toxoglossan gastropod *Mangelia brachystoma* (Philippi). *Proceedings of the Zoological Society of London*, 135: 319-338.
- RUDMAN, W. B., 1969, Observation on *Pervicacia tristis* (Deshayes, 1859) and a comparison with other toxoglossan gastropods. *Veliger*, 12: 53-64.
- SHERIDAN, R., VAN MOL, J.-J. & BOUILLON, J., 1973, Etude morphologique du tube digestif de quelques Turridae (Mollusca-Gastropoda-Prosobranchia-Toxoglossa) de la région de Roscoff. *Cahiers de Biologie Marine*, 14: 159-188.
- SHIMEK, R. L., 1975, The morphology of the buccal apparatus of *Oenopota levidensis* (Gastropoda, Turridae). *Zeitschrift für Morphologie der Tiere*, 80: 59-96.
- SHIMEK, R. L., 1977, *Resource utilization and natural history of some northeastern Pacific Turridae*. Ph.D. Dissertation, University of Washington, 232 p.
- SMITH, E. H., 1967, The proboscis and oesophagus of some British turrids. *Transaction of the Royal Society of Edinburgh*, 67: 1-22.
- SNEATH, P.H. A. & SOKAL, R. R., 1973, *Numerical taxonomy*. Freeman, San Francisco, 573 p.
- SOHL, N., 1977, Utility of gastropods in biostratigraphy. In KAUFFMAN, E. G. & HAZEL, J. E. (eds.), *Concepts and methods of biostratigraphy*. Dowden, Hutchinson & Ross, Stroudsburg, Penna., p. 519-539.
- STANLEY, S. M. & NEWMAN, W. A., 1980, Competitive exclusion in evolutionary time: the case of the acorn barnacles. *Paleobiology*, 6: 173-183.
- THIELE, J., 1929, *Handbuch der systematischen Weichtierkunde*. Gustav Fischer, Jena, 1: 1-376.
- TROSCHER, F. H., 1866, *Das Gebiss der Schnecken zur Begründung einer natürlichen Classification*, vol. 2. Nicolai, Berlin.
- WAGNER, W. H., Jr., 1969, The construction of a classification. In *Systematic biology*, Pub. 1692, National Academy of Sciences, Washington, D.C., p. 104-128.

## FEEDING MECHANISMS OF WEST AMERICAN NUDIBRANCHS FEEDING ON BRYOZOA, CNIDARIA AND ASCIDIACEA, WITH SPECIAL RESPECT TO THE RADULA

James Nybakken and Gary McDonald

*Moss Landing Marine Laboratories, P.O. Box 223, Moss Landing, CA 95039, U.S.A.*

### ABSTRACT

Employing information available in the literature and observations made over the last several years by personnel at the Moss Landing Marine Laboratories, correlations were sought between radula morphology of West American nudibranchs and type of prey consumed. The study was restricted to nudibranchs feeding upon Bryozoa, Tunicata and Cnidaria. Initial results indicated that one type of radula morphology characterized nudibranchs feeding on tunicates. Bryozoan and hydroid predators have more varied radulas. Closer examination of the latter revealed that in some cases radula morphology is correlated with the way in which the nudibranch feeds upon the prey. Different species have different ingestive mechanisms which are reflected in their radula types. Certain specialist nudibranchs were found to have unique radula types. A complicating factor in the analysis was the discovery that the radula type for certain species is different between juvenile and adult and often reflects different prey preferences. Suggestions are made for future work and limited predictions advanced for correlation of certain radula morphological types and special prey categories.

### INTRODUCTION

Since the early 1960s, several workers have dealt extensively with the food of nudibranch mollusks (Swennen, 1961; Miller, 1961, 1962; Thompson, 1964; McBeth, 1971; McDonald & Nybakken, 1978). The resulting body of literature emphasizes the identification and enumeration of the food items. However, there has been a lack of discussion of the relationships between actual feeding mechanisms and prey type. The only major correlation that has been documented is that of Bloom (1976) who was able to show a correlation between dorid radula morphology and certain broad aspects of sponge skeletal morphology. This is, however, a "loose" correlation involving mainly low encrusting sponges which behave as a relatively monotonous or homogeneous "grazing surface" in contrast to the array of higher invertebrate morphologies and textures for which nudibranchs have evolved strategies.

Those nudibranchs known to consume ascidians, bryozoans and cnidarians include species from not only the Doridacea, but also the Dendronotacea and Aeolidacea (McDonald & Nybakken, 1978). Considered together, these taxa have a much more diverse array of radula types. In addition, the

three prey taxa are themselves more highly varied in structure than the sponges. It would therefore seem likely that study of the radula types of the non-sponge consuming nudibranchs and the morphology of their prey would offer a chance to see if specific correlations can be established between radula morphology and prey type. If such broad correlation can be discerned, they may suggest certain mechanisms of feeding or, alternatively, special feeding strategies from which we might be able to make predictions concerning food and mechanisms of feeding for those nudibranch species for which food is currently unknown. The absence of correlations might suggest distinct methods of dealing with the same prey item which, in turn, would help to re-establish a correlation, or alternatively, that radular form is constrained predominantly by other factors unrelated to prey (see Hickman, 1980).

Our purpose is to test the hypothesis that there is a correlation between food type and radula morphology among non-sponge-eating nudibranchs. The data base for testing the hypothesis is McDonald & Nybakken (1978), plus additional observation of prey species by personnel at Moss Landing Marine Laboratories and known radula morphologies (MacFarland, 1966; McDonald, 1977). We

have restricted our correlation of radula morphology, food and feeding mechanisms to West American nudibranchs.

#### METHODS AND MATERIALS

The West American species of nudibranchs known to feed upon Ascidiacea, Bryozoa and Cnidaria were derived primarily from the summary paper of McDonald & Nybakken (1978). Additional information was provided by Cooper (1979) and unpublished observations by the authors and other personnel at Moss Landing Marine Laboratories accumulated over the last several years. Radular anatomy for all species is taken from descriptions and illustrations in McDonald (1977) or MacFarland (1966). For each radula, the general shape of the various teeth was noted and sketched, and the number of teeth per row and the number of rows of teeth noted. General size of the animals was also noted to see if radula morphology changes with age.

Morphological attributes were noted for nudibranch prey items as follows: For Bryozoa, each prey species was noted as being fleshy or calcified, with or without calcified front, with or without avicularia and encrusting or erect. Cnidaria consumed by Pacific coast nudibranchs fall into two classes, Hydrozoa and Anthozoa. Hydrozoan prey were ranked as to thecate or atehcate and whether erect or encrusting. Anthozoans were classified as to whether they were Octocorallia or Hexacorallia and each further subdivided into the respective orders. The radulas of nudibranchs feeding on unique prey items were further analyzed to identify any specialized features that might correspond to the anatomy or other features of their prey.

When correlations seemed unclear or absent, or when several different radula types were associated with the same prey type, we undertook further analyses of the various mechanisms of feeding to discern if the different radula types could be correlated with a certain way of attacking or consuming prey.

Finally, where data existed, we looked at the radula morphology of juvenile and adults of the species to see if there are changes in the radula and/or the prey consumed.

#### RESULTS

Food data and radula morphology were assembled for forty-four nudibranch species. The species, their average sizes, their distribution among the higher taxa and the category of prey consumed are given in Table 1. Those species that are reported to feed upon Bryozoa and Ascidiacea are compared with features of the prey in Table 2. In addition, certain features of the radula are presented. Tables 3 and 4 present a similar breakdown for the Cnidarian predators. For outline drawings of the radulas of all species, see McDonald (1977) and MacFarland (1966).

#### DISCUSSION

Are there any obvious aspects of radula morphology that can be correlated with feeding on a particular type of prey item? Within the limits of the current small sample size, we believe that two correlations stand out.

The first is seen in Table 2. Here, we find that only the two species of *Acanthodoris* and *Onchidoris muricata*, all members of the family Onchidorididae, feed upon fleshy Bryozoa or Tunicata. We have combined in the "fleshy" category both the Bryozoa of the order Ctenostomata, as well as the Ascidiacea, since both groups are grossly similar morphologically, with zooids living surrounded by a soft matrix and lacking opercula to close the opening to the outside. The radula morphology of these three species is similar. They all have relatively few teeth per row, usually from eight to sixteen, of which the marginal teeth are small and the single lateral on each side is enormously enlarged. The rachidian tooth is absent. Figure 1 illustrates the half row of the radula teeth of these three species, plus the radula teeth of the other species of *Acanthodoris* and *Onchidoris* found in California. The other four species of *Acanthodoris* are all similar in radula morphology, strongly suggesting to us that they should feed primarily on ctenostome Bryozoa or ascidians.

The other two species of *Onchidoris*, *O. bilamellata* and *O. hystricina*, have a very different radula morphology from *O. muricata*. In all three species, the lateral tooth is the largest in each row, but its shape is different (Fig.

TABLE 1. Nudibranch species investigated together with features of their size and main prey category.

Suborder	Family	Species	Avg. size of adult nudibranch	Category of prey consumed
Doridacea	Corambidae	<i>Corambe pacifica</i>	5 mm	Bryozoa
Doridacea	Corambidae	<i>Doridella steinbergae</i>	5 mm	Bryozoa
Doridacea	Okeniidae	<i>Ancula pacifica</i>	10 mm	Entoprocta
Doridacea	Okeniidae	<i>Hopkinsia rosacea</i>	20 mm	Bryozoa
Doridacea	Onchidorididae	<i>Acanthodoris nanaimoensis</i>	30 mm	Ascidiacea
Doridacea	Onchidorididae	<i>Acanthodoris pilosa</i>	25 mm	Ascidiacea
Doridacea	Onchidorididae	<i>Onchidoris bilamellata</i>	15 mm	Cirripedia
Doridacea	Onchidorididae	<i>Onchidoris muricata</i>	5 mm	Bryozoa
Doridacea	Triophidae	<i>Triopha catalinae</i>	40 mm	Bryozoa
Doridacea	Triophidae	<i>Triopha maculata</i>	15 mm	Bryozoa
Doridacea	Polyceridae	<i>Laila cockerelli</i>	15 mm	Bryozoa
Doridacea	Polyceridae	<i>Polycera atra</i>	12 mm	Bryozoa
Doridacea	Polyceridae	<i>Polycera hedgpethi</i>	15 mm	Bryozoa
Doridacea	Polyceridae	<i>Polycera zosteriae</i>	10 mm	Bryozoa
Dendronotacea	Tritoniidae	<i>Tritonia festiva</i>	20 mm	Cnidaria
Dendronotacea	Tritoniidae	<i>Tritonia diomedia</i>	150 mm	Cnidaria
Dendronotacea	Tritoniidae	<i>Tochuina tetraquetra</i>	120 mm	Cnidaria
Dendronotacea	Dendronotidae	<i>Dendronotus albus</i>	25 mm	Cnidaria
Dendronotacea	Dendronotidae	<i>Dendronotus diversicolor</i>	40 mm	Cnidaria
Dendronotacea	Dendronotidae	<i>Dendronotus frondosus</i>	25 mm	Cnidaria
Dendronotacea	Dendronotidae	<i>Dendronotus iris</i>	60 mm	Cnidaria
Dendronotacea	Dendronotidae	<i>Dendronotus subramosus</i>	25 mm	Cnidaria
Dendronotacea	Dotidae	<i>Doto amyra</i>	8 mm	Cnidaria
Dendronotacea	Dotidae	<i>Doto kya</i>	8 mm	Cnidaria
Arminacea	Arminidae	<i>Armina californica</i>	30 mm	Cnidaria
Arminacea	Dironidae	<i>Dirona picta</i>	25 mm	Cnidaria
Arminacea	Zephyrinidae	<i>Antiopella barbarenaensis</i>	20 mm	Bryozoa, Cnidaria
Aeolidacea	Coryphellidae	<i>Coryphella trilineata</i>	20 mm	Cnidaria
Aeolidacea	Coryphellidae	<i>Coryphella cooperi</i>	20 mm	Cnidaria
Aeolidacea	Coryphellidae	<i>Coryphella iodinea</i>	30 mm	Cnidaria
Aeolidacea	Eubbranchidae	<i>Cumanotus beaumonti</i>	8 mm	Cnidaria
Aeolidacea	Eubbranchidae	<i>Eubbranchus olivaceus</i>	8 mm	Cnidaria
Aeolidacea	Eubbranchidae	<i>Eubbranchus rustyus</i>	8 mm	Cnidaria
Aeolidacea	Cuthonidae	<i>Precuthona divae</i>	15 mm	Cnidaria
Aeolidacea	Cuthonidae	<i>Tenellia adspersa</i>	5 mm	Cnidaria
Aeolidacea	Cuthonidae	<i>Cuthona columbiana</i>	8 mm	Cnidaria
Aeolidacea	Fionidae	<i>Fiona pinnata</i>	20 mm	Cirripedia, Cnidaria
Aeolidacea	Facelinidae	<i>Phidiana crassicornis</i>	25 mm	Cnidaria, Ascidiacea
Aeolidacea	Facelinidae	<i>Phidiana hiltoni</i>	40 mm	Cnidaria
Aeolidacea	Aeolidiidae	<i>Aeolidia papillosa</i>	40 mm	Cnidaria
Aeolidacea	Aeolidiidae	<i>Aeolidiella takanosimensis</i>	25 mm	Cnidaria
Aeolidacea	Aeolidiidae	<i>Cerberilla mosslandica</i>	7 mm	Cnidaria
Aeolidacea	Spurillidae	<i>Spurilla oliviae</i>	20 mm	Cnidaria
Aeolidacea	Spurillidae	<i>Spurilla chromosoma</i>	20 mm	Cnidaria

TABLE 2. Radula characteristics of nudibranchs consuming Bryozoa and Ascidiacea, together with morphological features of the prey.

Nudibranch species	Radula		Bryozoa or Ascidiacea						
	Teeth per row	Broad or narrow	Fleshy or soft	Calci-fied front	Uncal-cified front	Encrust-ing	Erect	With avicu-laria	Without avicu-laria
<i>Corambe pacifica</i>	10-14	narrow			X	X			X
<i>Doridella steinbergae</i>	10-12	narrow			X	X			X
<i>Ancula pacifica</i> <sup>1</sup>	4	narrow							
<i>Hopkinsia rosacea</i>	4	narrow		X		X			X
<i>Acanthodoris pilosa</i>	8-10	narrow	X						
<i>Acanthodoris nanaimoensis</i>	10-16	narrow	X						
<i>Onchidoris muricata</i>	12	narrow	X	X	X	X		X	X
<i>Triopha catalinae</i>	40-82	broad			X		X	X	
<i>Triopha maculata</i>	20-39	broad			X	X	X	X	
<i>Laila cockerelli</i>	25-33	broad			X	X		X	
<i>Polycera atra</i>	8-12	narrow			X	X	X	X	
<i>Polycera hedgpethi</i>	10-12	narrow			X	X	X	X	
<i>Polycera zosteriae</i>	14-16	narrow			X	X	X	X	
<i>Antiopella barborensis</i>	29-45	broad			X		X	X	

<sup>1</sup>Feeding on phylum Entoprocta.

1). Furthermore, the number of teeth per row is reduced in both species to five, and a rachidian tooth is present. This suggests a different prey type, which indeed is the case. *Onchidoris bilamellata* is a specialist on barnacles (Miller, 1961; Swennen, 1961), while *O. hystericina* preys upon the bryozoan *Tubulipora* sp. (McDonald, 1977). The uniformity of radula anatomy among the fleshy bryozoan and tunicate feeders suggests that where this radula type is found, the species should feed in similar fashion upon similar prey. At this time, the question of how this particular morphology is related to the actual consumption of the prey is unknown.

A second strong correlation can be observed between radula morphology and anemones as prey items. Table 4 lists five species of aeolid nudibranch feeding on actiniarian anemones, and one species of

dendronotacean nudibranch, *Dendronotus iris*, feeding on ceriantharian anemones. The basic radula morphology of the five species feeding on actiniarian anemones, *Aeolidia papillosa*, *Aeolidiella takanosimenis*, *Cerberilla mosslandica*, *Spurilla oliviae* and *S. chromosoma*, is again very similar, as shown in Fig. 2. The radula in each case is uniseriate (one tooth per row). Each tooth is very broad and has the entire anterior border covered with small denticles. The actual form of the denticled border varies among the species from broadly concave to slightly convex, but the entire outline makes these radulas quite distinct. We predict that other eolids with this same radula morphology will also be found to feed upon actinarians.

A somewhat special case concerns *Dendronotus iris*, the only other Pacific coast nudibranch known to consume anemones.



TABLE 3. Radula characteristics of nudibranchs consuming hydrozoan prey, together with morphological features of the prey.

Nudibranch species	Radula				Hydrozoa		
	Uniseriate	Triseriate	Teeth per row	Broad or narrow	Thecate	Athecate	Chondrophore
<i>Dendronotus albus</i>			13-19	narrow	X		
<i>Dendronotus diversicolor</i>			13-19	narrow	X		
<i>Dendronotus frondosus</i>			13-23	narrow	X	X	
<i>Dendronotus subramosus</i>			5-15	narrow	X		
<i>Doto amyra</i>	X		1	narrow	X		
<i>Doto kya</i>	X		1	narrow	X		
<i>Dirona picta</i>			5	narrow	X		
<i>Coryphella trilineata</i>		X	3	narrow		X	
<i>Coryphella iodinea</i>		X	3	narrow		X	
<i>Coryphella cooperi</i>		X	3	narrow		X	
<i>Cumanotus beaumonti</i>		X	3	narrow		X	
<i>Eubranchus olivaceus</i>		X	3	narrow	X		
<i>Eubranchus rustyus</i>		X	3	narrow	X	X	
<i>Precuthona divae</i>	X		1	narrow		X	
<i>Tenellia adspersa</i>	X		1	narrow	X	X	
<i>Cuthona columbiana</i>	X		1	narrow	?	X	
<i>Fiona pinnata</i>	X		1	narrow			X
<i>Phidiana crassicornis</i>	X		1	narrow	X		
<i>Phidiana hiltoni</i>	X		1	narrow		X	
<i>Aeolidia papillosa</i>	X		1	narrow			
<i>Aeolidiella takanosimensis</i>	X		1	narrow			
<i>Cerberilla mosslandica</i>	X		1	narrow			
<i>Spurilla oliviae</i>	X		1	narrow			
<i>Spurilla chromosoma</i>	X		1	narrow			
<i>Antiopella barbarensis</i>			27-45	narrow		X	

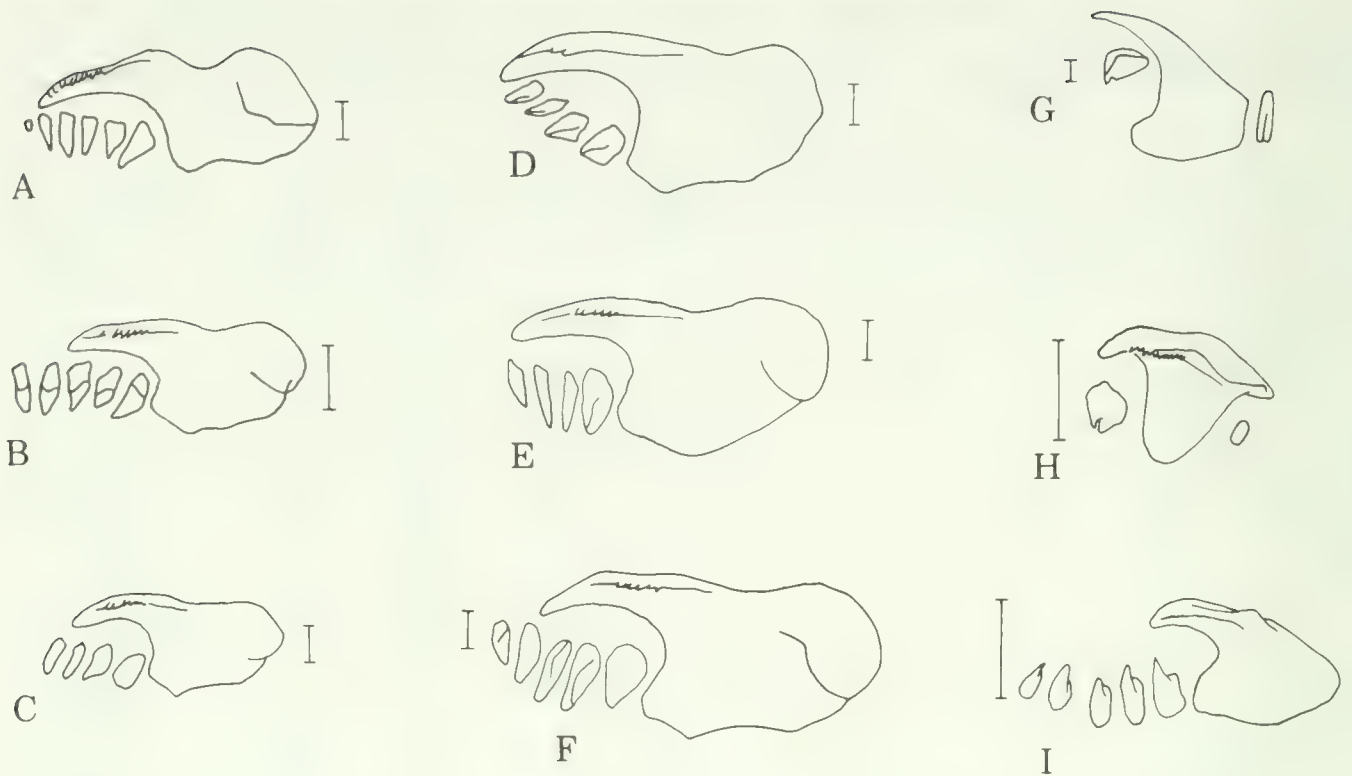

FIG. 1. Radulas of the Onchidorididae. A, *Acanthodoris brunnea*; B, *Acanthodoris hudsoni*; C, *Acanthodoris lutea*; D, *Acanthodoris nanaimoensis*; E, *Acanthodoris pilosa*; F, *Acanthodoris rhodoceras*; G, *Onchidoris bilamellata*; H, *Onchidoris hystricina*; I, *Onchidoris muricata*. The bars represent 50  $\mu\text{m}$ . Each radula is a single half row with marginals to the left.

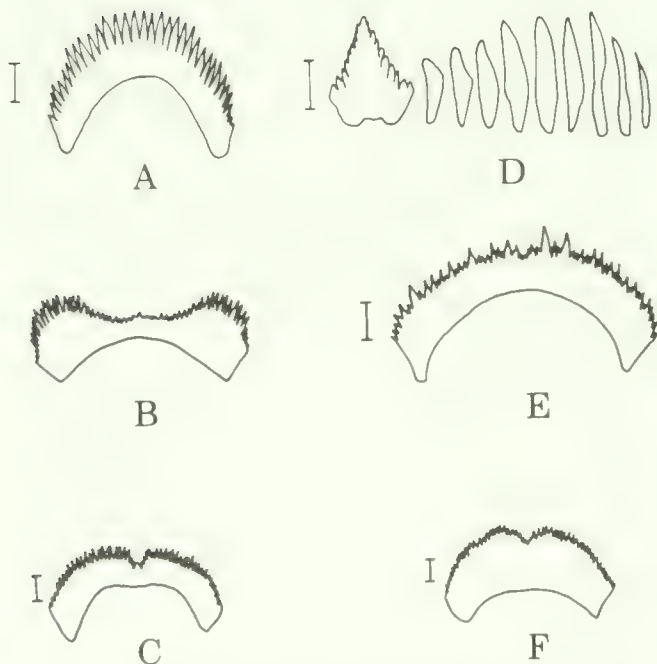

FIG. 2. Radulas of anemone predators. A, *Aeolidia papillosa*; B, *Aeolidiella takanosimensis*; C, *Spurilla chromosoma*; D, *Dendronotus iris*; E, *Cerberilla mosslandica*; F, *Spurilla oliviae*. The bars represent 50  $\mu\text{m}$ . The radula of *D. iris* is a half row, rachidian to the left, laterals and marginals to the right.

*Dendronotus iris*, as an adult, is a specialist on the ceriantharian anemone *Pachycerianthus fimbriatus*. In contrast to its co-occurring congeners, it has a radula with 23–24 teeth per row; none of its Pacific coast relatives have more than 23 teeth per row. The shape of the teeth of *D. iris* is similar to those of its hydroid consuming congeners, except for the absence of serrations on the marginal and lateral teeth. It is not likely that one could predict the food source here from radula anatomy alone. We believe this is partially due to the different mechanisms of dealing with the prey. *Dendronotus iris* is reported by Wobber (1970) to climb up on the tubes of *P. fimbriatus* and selectively attack the tentacles of the anemone. The aeolid anemone feeders generally feed on whole anemones (Waters, 1973). Here is a case where further study of the actual feeding process between these two groups might elucidate the significance of the different radula morphology.

Three dendronotacean nudibranchs, *Tochuina tetraquetra*, *Tritonia diomedea* and *T. festiva*, plus the arminacean *Armina californica*, are known to consume octocorallians (Thompson, 1971; Wicksten & DeMartini,

TABLE 4. Radula characteristics of nudibranchs consuming anthozoan prey and morphological features of the prey.

Nudibranch species	Teeth per row	Broad or narrow	Anthozoa					Alcyonacea	Other food
			Actin-aria	Cerian-tharia	Stolo-nifera	Pennatu-lacea	Gorgo-nacea		
<i>Tritonia diomedia</i>	117-193	broad				X			
<i>Tritonia festiva</i>	36-72	narrow			X	X	X		
<i>Tochuina tetraquetra</i>	328-625	broad				X		X	
<i>Dendronotus frondosus</i>	13-23	narrow						Ascidiacea	
<i>Dendronotus iris</i>	23-43	narrow		X					
<i>Armina californica</i>	81-163	broad				X			
<i>Dirona picta</i>	5	narrow						Bryozoa	
<i>Coryphella iodinea</i>	3	narrow						Ascidiacea	
<i>Phidiana crassicornis</i>	1	narrow				X		Ascidiacea	
<i>Aeolidia papillosa</i>	1	narrow	X						
<i>Aeolidiella takanosimensis</i>	1	narrow	X						
<i>Cerberilla mosslandica</i>	1	narrow	X						
<i>Spurilla oliviae</i>	1	narrow	X						
<i>Spurilla chromosoma</i>	1	narrow	X						
<i>Antiopella barbarendis</i>	29-45	narrow						Bryozoa	

1973). In the case of the three dendronotaceans, the radulas are very similar in the form of the individual teeth (Fig. 3). The lateral teeth are strong and the marginals are curved. *Armina californica* has much different teeth, in that they are bifid at the tips and less massive. Both *A. californica* and the dendronotaceans, however, share the characteristic of having many teeth per row (Table 4) and therefore, of having a broad radula. The major exception is *T. festiva*, the smallest of the group (Table 1). *Tritonia festiva* is the only species to feed on the octocoral order Stolonifera, specifically a species of the genus *Clavularia*. Whereas other octocorals (Pennatulacea, Gorgonacea, Alcyonacea) are rather large, massive colonies, usually much larger than the nudibranch, *Clavularia* sp. is a very tiny form, often smaller than *T. festiva*. The individual polyps of *Clavularia* sp. arise from a

single, narrow stolon attached to the rock, and the unusually narrow radula of *T. festiva* seems to correlate with the morphology of the prey. A larger, more massive radula would not be as effective.

Of those nudibranchs for which we have data, two specialists occur, *Ancula pacifica* and *Hopkinsia rosacea*. The former feeds on members of the small phylum Entoprocta and the latter on the encrusting bryozoan *Eury-stomella bilabiata* (McBeth, 1971). Both species have only four teeth per row, but the morphology of the teeth of the two species is very different (Fig. 4). We know little about the feeding behavior of *A. pacifica*, but for *H. roseacea* we can note that it is the only one of the bryozoan feeders which feeds exclusively on a bryozoan that has a calcified front. Presumably, this is facilitated by the strong lateral teeth with the hooks on the inner edge. We

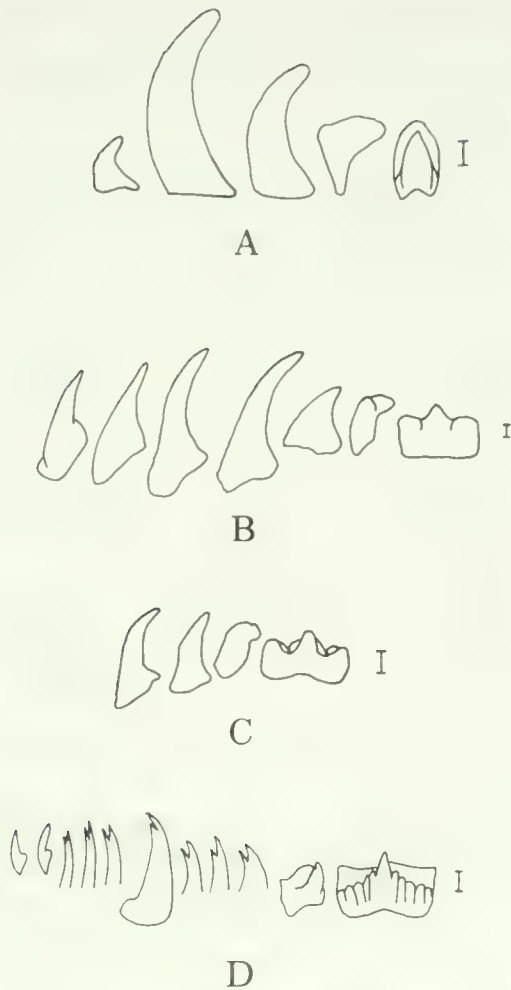

FIG. 3. Radulas of octocoral predators. A, *Tochuina tetraquetra*; B, *Tritonia diomedea*; C, *Tritonia festiva*; D, *Armina californica*. The bars represent 50  $\mu\text{m}$ . Each radula represents a half row with rachidian to the right and laterals and marginals to the left.

think that the combination of massive lateral teeth, no rachidian and small marginals, is an adaptation to attack Bryozoa with calcified fronts, more specifically, to break the individual zooecia, rather than to graze up large numbers of polypides at one time, such as seen in the other bryozoan feeders (Table 2). This idea is reinforced by noting the narrowness of this radula as compared to that of the other bryozoan feeders (Table 2).

Among the remaining nudibranchs considered here, it is difficult to find any obvious radula morphology associated with a particular type of prey. We therefore asked ourselves whether there might be correlations if we looked more closely at just how a series of nudibranch predators handle their food. For this, it was necessary to find studies in which the actual mechanism of feeding was described for nudibranchs feeding on a single class of prey items. We were fortunate in find-

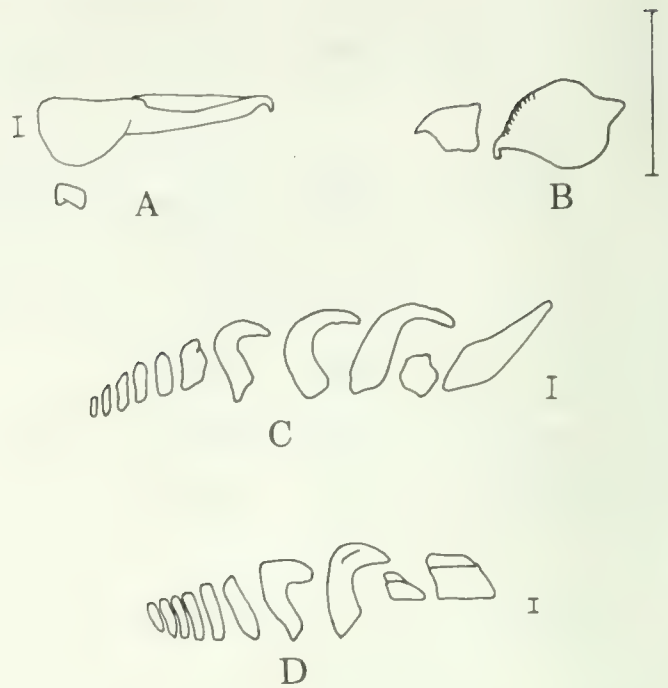

FIG. 4. Specialists and bryozoan predators. A, *Hopkinsia rosacea*; B, *Ancula pacifica*; C, *Triopha catalinae*; D, *Triopha maculata*. The bars represent 50  $\mu\text{m}$ . Each radula is a half row with rachidian teeth to the right in *Triopha* and laterals and marginals to the left. In *Hopkinsia* and *Ancula*, the larger tooth is a lateral, the smaller a marginal.

ing two such studies (Waters, 1966; Cooper, 1979) that included data on specific feeding strategies of aeolid nudibranchs feeding on hydroids.

As may be seen in Table 3, many aeolid nudibranchs feed upon hydroids. These aeolids fall into two classes with respect to the radulas, either uniseriate (one tooth per row) or triseriate (three teeth per row). The hydroids upon which they feed may be either thecate (polyps covered by a hard perisarc) or athecate (polyps naked). Our initial grouping in Table 3 revealed no strong correlation between radula type and hydroid type. Aeolids with both uniseriate and triseriate radulas were reported to feed on both thecate and athecate hydroids.

Cooper (1979) studied the nudibranchs associated with the athecate hydroid *Tubularia crocea* and carefully noted those which fed on it and where. Waters (1966) made similar careful observations on the aeolids feeding on the thecate hydroid *Obelia commissuralis*.

Tables 5 and 6 list the species of nudibranchs found with each of these prey species and a summary of where the nudibranchs were found feeding on the hydroid, or if they were found not to be feeding or feeding only on other hydroids.

TABLE 5. *Tubularia*-associated nudibranchs (from Cooper, 1979). Numbers in parentheses indicate whether radula is uniseriate (1) or triseriate (3).

Species	Feeding on			Not feeding or feeds on other hydroids
	Hydranth	Gonophores	Stolon	
<i>Coryphella cooperi</i>	X (3)	X		
<i>Coryphella trilineata</i>	X (3)	X		
<i>Coryphella</i> sp.	X (3)	X		
<i>Cuthona albocrusta</i>			X (1)	
<i>Cuthona columbiana</i>			X (1)	
<i>Tenellia adspersa</i>			X (1)	
<i>Phidiana crassicornis</i>	X (1)			
<i>Cuthona fulgens</i>				X
<i>Dendronotus iris</i>				<i>Obelia</i>
<i>Dendronotus frondosus</i>				<i>Obelia</i>
<i>Doto amyra</i>				<i>Bougainvillia</i>
<i>Eubranchus rustysus</i>				<i>Obelia</i>

TABLE 6. Nudibranchs associated with *Obelia commissuralis* (from Waters, 1966).

Species	Feeding on		Radula	
	Hydranth	Stolon	Triseriate	Uniseriate
<i>Eubranchus olivaceus</i>	X		X	
<i>Cuthona concinnia</i>		X		X
<i>Coryphella fusca</i>	X		X	
<i>Phidiana crassicornis</i>	X			X

Once this breakdown is done, some correlations are suggested when one considers an additional fact concerning thecate and athecate hydroids. That fact is that in both hydroid divisions, the main stalks and stems are covered with a tough chitinous perisarc and the only difference between the two is that, in thecate hydroids, the perisarc extends up around the base of the hydranth, but does not cover it.

Examination of Tables 5 and 6 reveals that, with one exception, those eolids with triseriate radulas fed upon the naked hydranths or gonophores, whereas those nudibranchs with uniseriate radulas fed upon the stolons that are covered with a perisarc. It seems likely that the uniseriate radula is better adapted for drilling holes than is a radula with three teeth per row. This observation is supported by the fact that sacoglossan opisthobranchs all have uniseriate radulas and all are known to use these to pierce the tough cell walls of certain algal cells (Thompson, 1976). The single exception in our study is *Phidiana crassicornis*, which is known to be a generalist feeding on many different groups.

Our analysis also points out the danger of listing as a food source the hydroid upon which a nudibranch is found. As Table 5 shows, Cooper (1979) found five species of nudibranch associated with *T. crocea* that feed only upon other hydroids.

Unfortunately, we do not have more detailed information for the exact mechanism of feeding on hydroids by other eolids. We therefore cautiously predict from this small sample size that future studies should indicate that, in general, hydroid-feeding nudibranchs with uniseriate radulas should feed by piercing the stolons, stems or hydrothecae of hydroids and triseriate species should feed on the polyps without piercing the perisarc.

The only group of bryozoan feeders for which detailed data exist with respect to the mechanism of feeding are the two species of *Triopha*, *T. catalinae* and *T. maculata*. These two species have somewhat different radulas, but they are not markedly divergent (Fig. 4). One significant difference is that there are more teeth per row in *T. catalinae* and hence the radula is more broad (Table 2). As Nybakken & Eastman (1977) have shown,

these two species differ in their prey preference, *T. catalinae* feeding on erect Bryozoa and *T. maculata* mainly on encrusting forms. The teeth of *T. catalinae* are more "hooked," which corresponds to its mechanism of feeding, which is to rip off whole pieces of the erect bryozoans. In contrast *T. maculata* has a narrower, less robust radula and less "hook" to the teeth and feeds by scooping out the polypides from the bryozoans.

If our observations hold true in future studies of bryozoan feeders, we would expect a broad radula and strongly hooked teeth to be associated with species feeding on erect Bryozoa, whereby the colony pieces are actually ingested. Conversely, we might expect that narrower radulas (fewer teeth per row) and those with less "hook" to them, would be features of species that feed on encrusting (perhaps also erect) bryozoans in which polypides are grazed out and the remainder of the colony left intact.

Although the results discussed above suggest that, at least in some cases, it is possible to relate radula morphology to food and/or feeding mechanism, this is not always the case. One reason for the difficulty may lie in the fact that both radula morphology and prey species consumed may change during ontogeny. Two examples are documented from work at Moss Landing Marine Laboratories. Nybakken & Eastman (1977) found that the radula anatomy of *Triopha maculata* was different between juveniles and adults. The juveniles had but one marginal tooth, whereas adults had from four to eight marginal teeth. Correlated with that difference was a change in diet, the juveniles feeding primarily on encrusting bryozoans, while the adults fed on both encrusting and arborescent bryozoans. Similarly, Cooper (1979) reported *Dendronotus iris* juveniles to be found associated with, and consuming, *Obelia*, whereas the adults are seemingly specialist predators on the anemone *Pachycerianthus fimbriatus*. Unfortunately, in the latter case, no radula preparations were made of the juveniles. Similar changes in diet with age have been reported for *D. frondosus* by Thompson (1964).

These latter two observations suggest two things; first, that more specific correlations between certain radula morphological types and prey reported in the literature may be obscured by not knowing if the animal was a juvenile or an adult and/or by not checking to see if the radula was the same in both juvenile and adult; secondly, the fact that, in those

cases investigated where the radula morphology does undergo change, there is also a corresponding change in the major food. Both observations support the contention that radula morphology is indeed correlated with type of prey and/or mechanism of feeding. Finally, it is not clear to what extent convergence in feeding behavior has directed evolution of radula morphology and what specific radular characters are most directly affected. It may thus be that future, more careful, studies of nudibranchs, particularly the changes in both food and radulas between juveniles and adults, may well elucidate some of these correlations.

### CONCLUSIONS

1. Aeolid nudibranchs that feed on anemones tend to have uniseriate radulas with broad teeth that are heavily serrated on the anterior border.

2. Nudibranchs that feed either on fleshy ctenostome bryozoans or ascidians have similar radula morphologies with each half row dominated by a very large, massive  $\neg$ -shaped lateral tooth.

3. Aeolid nudibranchs that feed on hydroids have uniseriate or triseriate radulas. Those with uniseriate radulas prey upon hydroids by puncturing the perisarc, usually somewhere along the stolon or stem, and eating out the coenosarc. Those with triseriate radulas tend to feed directly upon the polyps.

4. Most bryozoan feeders prey upon bryozoans which lack calcified fronts (*Anasca*).

5. Nudibranchs that feed on members of the orders Pennatulacea, Gorgonacea and Alcyonacea have very broad radulas. Those that feed on the order Stolonifera have narrow radulas.

6. Some specialists, such as *Hopkinsia rosacea* and *Ancula pacifica*, have unique radulas that may be related to the specific prey item.

6. Evidence exists for a few nudibranchs that radula morphology and food preference change with ontogeny.

### ACKNOWLEDGEMENTS

The authors thank Dr. Carole Hickman and Mr. David Lindberg for reviewing the manuscript, John Cooper for providing some of the much needed data, and Ms. Lynn McMasters for drawing the figures.

## LITERATURE CITED

- BLOOM, S. A., 1976, Morphological correlations between dorid nudibranch predators and sponge prey. *Veliger*, 18: 289-301.
- COOPER, J., 1979, *Ecological aspects of Tubularia crocea (Agassiz, 1862) and its nudibranch predators in Elkhorn Slough, California*. MS thesis, California State University, Hayward, 107 p.
- HICKMAN, C., 1970, Gastropod radulae and the assessment of form in evolutionary paleontology. *Paleobiology*, 6: 276-294.
- MACFARLAND, F. M., 1966, Studies of opisthobranchiate mollusks of the Pacific coast of North America. *Memoirs of the California Academy of Sciences*, 6: xvi + 546 p., 72 pl.
- MCBETH, J. W., 1971, Studies on the food of nudibranchs. *Veliger*, 14: 158-161.
- MCDONALD, G. R., 1977, *A review of the nudibranchs of the California coast*. MS thesis, California State University, Hayward, 373 p.
- MCDONALD, G. R. & NYBAKKEN, J. W., 1978, Additional notes on the food of some California nudibranchs with a summary of known food habits of California species. *Veliger*, 21: 110-119.
- MILLER, M. C., 1961, Distribution and food of the nudibranchiate Mollusca of the south of the Isle of Man. *Journal of Animal Ecology*, 30: 95-116.
- MILLER, M. C., 1962, Annual cycles of some Manx nudibranchs with a discussion of the problem of migration. *Journal of Animal Ecology*, 31: 545-569.
- NYBAKKEN, J. W. & EASTMAN, J., 1977, Food preference, food availability and resource partitioning in *Triopha maculata* and *Triopha carpenteri* (Opisthobranchia: Nudibranchia). *Veliger*, 19: 279-289.
- SWENNEN, C., 1961, Data on distribution, reproduction and ecology of the nudibranchiate Mollusca occurring in the Netherlands. *Netherlands Journal of Sea Research*, 1: 191-240.
- THOMPSON, T. E., 1964, Grazing and the life cycles of British nudibranchs, p. 275-287. In: CRISP, D. J. (ed.), *Grazing in Terrestrial and Marine Environments*. Blackwell, Oxford, England.
- THOMPSON, T. E., 1971, Tritoniidae from the North American Pacific coast (Mollusca: Opisthobranchia). *Veliger*, 13: 333-338.
- THOMPSON, T. E., 1976, *Biology of opisthobranch molluscs*. Vol. 1. Ray Society, vol. 151, 207 p.
- WATERS, V., 1966, *Feeding ecology and other aspects of the natural history of the nudibranch, Eubranchus olivaceus*. MS thesis, University of Washington, 88 p.
- WATERS, V., 1973, Food preferences of the nudibranch *Aeolidia papillosa* and the effect of the defenses of the prey on predation. *Veliger*, 15: 174-192.
- WICKSTEN, M. K. & DEMARTINI, J., 1973, Observations of the feeding habits of *Tochuina tetraquetra* (Pallas) (Gastropoda, Tritoniidae). *Veliger*, 15: 195.
- WOBBER, D. R., 1970, A report on the feeding of *Dendronotus iris* on the anthozoan *Cerianthus* sp. from Monterey Bay, California. *Veliger*, 12: 383-387.





## THE ROLE OF CARNIVOROUS GASTROPODS IN THE TROPHIC ANALYSIS OF A FOSSIL COMMUNITY

Robert J. Stanton, Jr.,<sup>1</sup> Eric N. Powell<sup>2</sup> and Penelope C. Nelson<sup>3</sup>

### ABSTRACT

Trophic structure is an essential attribute in the description and analysis of a community. It is particularly useful in the study of fossil communities because it is relatively independent of geologic time. That is, pathways of energy flow in a community and efficiencies from level to level in the ecological pyramid have probably changed relatively little through time compared to the changes in the species composition of the community.

Reconstruction of the trophic structure of a fossil community is severely hampered by the bias introduced by nonpreservation of the soft-bodied organisms. Among the preserved component, gastropods are the dominant carnivores, particularly in Mesozoic and Cenozoic communities. Consequently, they are the key element in any attempt to reconstruct the trophic structure of the original community.

Numerical abundance of individuals is the simplest means of estimating the relative importance of the different gastropod taxa within the community. Differences in size frequency distributions and in survivorship curves for the taxa present in the community indicate, however, that age and size attributes of the population as well as number of individuals must be considered in a detailed analysis of trophic structure. A trophic analysis should be based on measures of energy flow through the community rather than on numerical abundances. Calculations of produced biomass (growth) and cumulative biomass (maintenance) incorporate these attributes and provide estimates of energy flow in the community. They also incorporate a time dimension, which is necessary in paleoecologic interpretation of a time-averaged fossil assemblage but which may not be a consideration in an ecological study. These biomass measures for the carnivorous gastropods can be used to estimate prey production.

In the Eocene Stone City Formation, the fossil assemblage consists of more than 100 species, but biomass calculations indicate that far less than half of the original community is preserved. The non-preserved part consists primarily of crustaceans at the carnivore level and of deposit feeding soft-bodied organisms at the primary consumer level.

### INTRODUCTION

A major trend in paleoecology in recent years has been to analyze the fossil record from an increasingly biological point of view. One aspect of this line of investigation has been to consider fossil assemblages as relict representations of original communities of organisms. The comparison has been, and is largely still in taxonomic terms. The fossil communities are compared with one another and with modern communities by similarities in taxa present. If the age differences between the fossil assemblages is not great, the taxonomic level of comparison may be the genus or even the species; with greater age differences the comparison may be at the order or family level.

In the development of community paleo-

ecology, however, structural attributes have become increasingly important. Measures of diversity have been particularly useful, and the paleoecologist has avidly attempted to employ the concepts, indices and interpretations of diversity that have been so plentiful in the ecological literature during the past fifteen years. In more recent years, trophic structural characteristics have been increasingly examined as a means of comparing fossil communities (Walker, 1972; Walker & Bambach, 1974; Stanton & Dodd, 1976; Hoffman et al., 1978; Scott, 1978; Bosence, 1979).

The ultimate objective of community paleoecology would be to reconstruct from the fossil assemblage the original community from which it had been derived. This is clearly a difficult if not impossible task because the original community is generally very poorly

<sup>1</sup>Department of Geology, Texas A&M University, College Station, TX 77843, U.S.A.

<sup>2</sup>Department of Oceanography, Texas A&M University, College Station, TX 77843, U.S.A.

<sup>3</sup>1504 E 37th St., Tulsa, OK 74105, U.S.A.

preserved. Reconstruction of the original community is very important, however, for several reasons. First, it is the only way to recognize and describe the non-preserved component of the fossil record. Thus it leads to improved knowledge of the fossil record. Nonpreservable organisms in Recent communities comprise 50–75% of the total number of organisms present (Lawrence, 1968; Stanton, 1976; Schopf, 1978). As in modern communities, the non-preserved component of ancient communities probably included a number of numerical dominants (Sanders, 1958; Holland et al., 1973; Maurer, 1977) as well as species that may have strongly influenced community composition through processes such as sediment reworking (Myers, 1977 a, b), sediment stabilization (Young & Rhoads, 1971; Wilson, 1979), and predation (Virnstein, 1977, 1979). Second, the interpretation of the fossil community leads to improved paleoenvironmental reconstruction because the paleoecologist is able to deal with a greater proportion of the original biota, because trophic and other structural characteristics can be directly interpreted environmentally, and because the processes that have led to some parts of the original community being preserved and others destroyed can be recognized and are symptomatic, themselves, of environmental conditions. Third, by attempting to reconstruct the original community, the paleoecologist is in a position to ask questions about the biological aspects of the ancient ecosystem such as the evolution of communities, niches, and organism interactions. The role of gastropods in ancient communities is of major importance because they are the dominant carnivore preserved in many fossil assemblages.

Community paleoecology requires three types of data. The first is a comprehensive knowledge of the fossil record. Although biostratigraphy and many other paleontologic disciplines can function with only the dominants in the fauna, paleocommunity analysis depends upon as full a representation of the taxa in the assemblage as possible, as well as information about the relative abundances and population dynamics of the taxa. The second type of data is that derived from a thorough taphonomic analysis of the fossil assemblage. That is, an analysis of the fossils and the sediments in which they occur in order to identify and evaluate the processes that resulted in the fossil assemblage as a more or less biased representation of the

original community. The third type of data consists of well-documented modern communities and detailed life histories of comparable modern species that can serve as analogues for the fossil communities and taxa.

Trophic analysis is a major component of paleocommunity reconstruction. It provides insight into the functional relationships within the community by examining one of the important parameters binding the organisms together into the community—their trophic interactions. Because the preservable and non-preserved components in a fossil community must have been tied together in the trophic web, the nature and importance of the soft-bodied fauna in the original community can be inferred through trophic analysis of the fossil assemblage. These inferences can be drawn from either preserved prey which show evidence of predation, such as mollusc shells with crab nips on them, or preserved predators that fed on non-preserved prey. In most fossil assemblages, the predators that are preserved are primarily gastropods. In this study, for example, almost all the gastropods, which amount to about half of the assemblage, are carnivores.

The objectives of this paper are to describe an Eocene assemblage and the original community as far as it can be reconstructed from the fossil assemblage and to analyze the role played by the predatory gastropods in the community.

## GEOLOGIC SETTING

The Stone City Formation (Claiborne Group, Middle Eocene) consists of interbedded fossiliferous bioturbated glauconite pellet sandstone and laminated lignitic mudstone at its type locality on the Brazos River in southeastern Texas (Fig. 1). The Formation was deposited during the initial transgressive phase of a major Eocene depositional cycle in the northwest Gulf of Mexico. The upward increase in the proportion of glauconite sandstone to lignitic mudstone reflects progressively more marine conditions during deposition. The depositional setting was probably similar to that of the lakes and sounds northeast of the present Mississippi Delta. The fauna of the Main Glauconite bed, near the top of the Stone City Formation, is the basis of this study. The bed consists predominantly of ovoidal glauconitized fecal pellets 0.5 mm long and 0.2 mm across in a matrix consisting

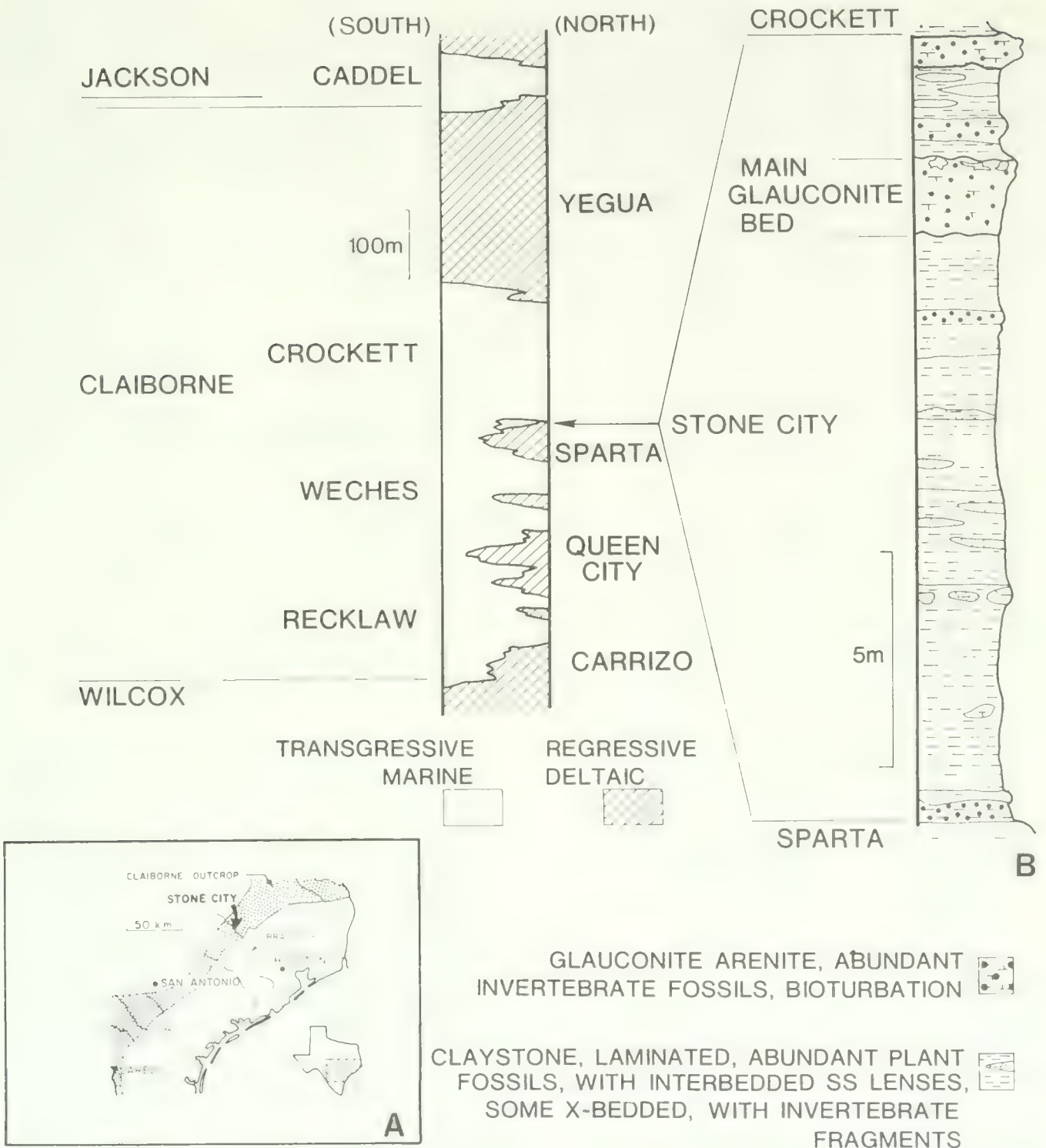

FIG. 1. Location of the study site and stratigraphic setting of the Main Glaucconite bed, Stone City Formation. A, Outline map of Texas; location of the Stone City study site within the Claiborne outcrop belt. B, Location of Stone City Formation within the Middle Eocene transgressive-regressive stratigraphy; lithology of the Stone City Formation.

of equal proportions of clay and fine to very fine, well sorted, angular quartz sand. The fecal pellets and sediment texture suggest that the sediments were thoroughly mixed by bioturbation during deposition. More comprehensive and detailed descriptions of the Formation can be found in Stenzel, Krause & Twining (1957), Stanton & Warme (1971), and Stanton (1979).

FOSSIL ASSEMBLAGE

Macrofossils greater than 1 mm across form the primary data for this study. The body fossils are scattered uniformly throughout the bed and are generally in excellent condition with original shell material and fine morphologic details preserved. Microfossils have been studied in only general terms by us (see,

TABLE 1. Taxonomic and trophic characteristics of the fossil assemblage. Col. 1: Number of genera and species within the taxon; Col. 2: Percent of individuals in macrofossil assemblage belonging to taxon; Col. 3: Trophic level of taxon in ecologic pyramid—1: Primary producer; 2: primary consumer; 3–5: low to high levels of carnivory; Col. 4: Abundance of bored individuals in taxon—A: greater than 20% of individuals; C: 10–20%; P: 5–10%; R: less than 5% of individuals are bored; Col. 5: Abundance of crustacean-chipped specimens in taxon—percentage ranges as in Column 4; Col. 6: Feeding information for the taxon.

	1 G-S	2 %	3 T.L.	4 Bor.	5 Chip.	6 Feeding habits
Coelenterata		6.5	3			carnivorous
Scleractinia	2-2	6.2	3	—	—	
Alcyonaria	1-1	0.3	3	—	—	
Bryozoa	6-7	2.9	2	—	—	phytoplankton
Scaphopoda	2-2	1.9	3	C	C	carnivorous on forams, small bivalves
Gastropoda		49.3				
Fissurellidae	1-1	<0.1	2-3	—	R	detritus and carnivorous on small sponges
Turbinidae	1-1	0.1	2	—	R	benthic diatoms, filamentous algae, eaten by Fascioliariidae
Vitrinellidae	2-2	0.1	?	R	P	
Architectonicidae	1-4	0.4	4	R	C	carnivorous on anemones
Turritellidae	2-6	2.2	2	A	A	suspended detritus and phytoplankton
Caecidae	1-1	0.2	2	—	C	interstitial diatoms
Epitoniidae	2-3	0.1	4	—	C	carnivorous and parasitic on coelenterates
Eulimidae	2-3	0.2	4	—	—	parasitic on echinoderms (starfish, holothurians), polychaetes
Pyramidellidae	1-1	0.1	4?	P	—	parasitic/carnivorous on polychaetes, bivalves
Naticidae	3-3	16.1	3-4	C	A	carnivorous on bivalves, gastropods, scaphopods
Ficidae	1-2	0.7	?	—	P	?
Cymatiidae	1-1	0.2	3-4	P	P	carnivorous on mollusks
Muricidae	1-1	<0.1	3	—	—	carnivorous on bivalves, barnacles, gastropods
Pyramimitridae	1-1	<0.1	?	—	P	?
Buccinidae	2-5	3.0	3	C	C	scavengers; carnivorous on bivalves, crustaceans, worms
Nassariidae	1-1	0.6	2	A	A	nonselective deposit feeder: diatoms, detritus; scavenger
Fascioliariidae	2-2	2.6	3-4	P	P	carnivorous on gastropods, bivalves, polychaetes, barnacles
Volutidae	1-2	1.1	3	R	P	carnivorous on bivalves
Olividae	1-1	0.3	3	R	C	carnivorous on small mollusks, forams
Marginellidae	1-1	0.4	4?	—	P	carnivorous on ?
Mitridae	1-1	<0.1	4?	—	R	carnivorous on crustaceans, sipunculid worms
Cancellariidae	2-3	2.0	3	P	C	carnivorous on soft-bodied interstitial microorganisms
Conidae	1-1	<0.1	4	—	P	carnivorous on herbivorous polychaetes, fish, gastropods
Terebridae	2-2	2.5	4	P	P	carnivorous on worms, enteropneusts
Turridae	12-14	12.9	3-4	P	C	carnivorous on annelids, nemertean
Acteocinidae	1-2	2.9	3-4	R	C	carnivorous on other opisthobranchs, forams
Mathildidae	2-3	0.2	?	—	C	?
Ringiculidae	1-1	0.2	3	R	—	carnivorous on polychaetes, forams
Bivalvia		36.6				feed from suspension or sediment surface. Dietary preferences generally not known, probably largely microflora and detritus but nonselective, including bacteria, microfauna.
Nuculidae	1-1	2.1	2	C	P	deposit feeder
Nuculanidae	1-4	3.0	2	—	C	deposit feeder
Arcidae	1-1	0.2	2	—	R	suspension feeder
Noetiidae	1-2	2.6	2	R	R	suspension feeder
Ostreidae	2-2	1.1	2	P	P	suspension feeder
Anomiidae	1-1	1.6	2	R	C	suspension feeder

TABLE 1 (Cont.)

	1 G-S	2 %	3 T.L.	4 Bor.	5 Chip.	6 Feeding habits
Carditidae	1-1	2.4	2	R	C	suspension feeder
Diplodontidae	1-1	0.5	2	—	C	suspension feeder
Semelidae	1-1	0.3	2	R	R	suspension feeder
Tellinidae	1-2	0.2	2	—	P	deposit feeder
Mactridae	1-1	0.1	2	R	P	suspension feeder
Veneridae	1-1	0.3	2	—	R	suspension feeder
Corbulidae	3-3	23.3	2	C	C	suspension feeder
Cephalopoda ( <i>Aturia</i> , <i>Belosepia</i> )		0.1	3-5	—	—	carnivorous on crustaceans, fish, mollusks
Echinodermata (heart urchin)		<0.1	2	—	—	non-selective deposit feeder
Arthropoda (crustacean)		<0.1	3-4	—	—	carnivorous, scavenger
Foraminifera		<0.1	3	—	—	diatoms, bacteria
Chordata						
Elasmobranchii	3-3	<0.1	5	—	—	carnivorous on fish, cephalopods
Congridae	1-1	<0.1	3-5	—	—	carnivorous on bottom-living fish, crustaceans, cephalopods
Beryciformis	1-2	0.8	3-5	—	—	carnivorous on benthic crustaceans
Serranidae	1-1	<0.1	3-5	—	—	carnivorous on benthic crustaceans and polychaetes as juvenile, on small fish as adult
Scianidae	3-3	0.8	3-5	—	—	carnivorous on benthic polychaetes and crustaceans, mollusks?; planktonic crustaceans, fish and squid
Ophididae	3-3	0.8	3-5	—	—	carnivorous on benthic crustaceans (shrimp, crabs, stomatopods), juvenile fish, polychaetes
Soleidae	1-1	<0.1	4-5	—	—	carnivorous on benthic crustaceans

however, Greenfield, 1957). The sample consists of 6,616 individuals representing 96 genera and 120 species. Table 1 lists the fauna at the taxonomic level for which information about trophic characteristics could be found.

Before the original community characteristics can be derived from the fossil assemblage, the post-mortem processes that may have modified the community must be considered. Non-preservation of soft-bodied individuals was probably the principal modifying process. Solution of the calcareous shells was probably not important, based on the fact that small and fragile shells and fine sculptural detail are all excellently preserved. The importance of physical processes that might have mixed, winnowed, abraded, and broken shells was minor, based on analysis of 1) shell condition, sorting and orientation, 2) sedimentary structures, and 3) right-left ratios of bivalves.

In general, the assemblage is an in-place residue of the original community, with modifications resulting primarily from non-preservation of soft-bodied organisms and biological processes, such as predation. For a more detailed description of the fauna, construction of Table 1, laboratory procedures, and taphonomic analysis, see Stanton & Nelson (1980).

Richness or species diversity is high but equitability is low in the assemblage (Fig. 2). Size-frequency diagrams and survivorship curves have been calculated for some of the most common organisms (Figs. 3-11). In these diagrams, gastropod size is shell length from apex to abapical point. Bivalve size is anterior-posterior length. Size values have been converted to age values using the general logarithmic relationship between the two (Levinton & Bambach, 1969). The maximum age value for each population is based on the largest specimen, assuming that the largest shell found represents the oldest indi-

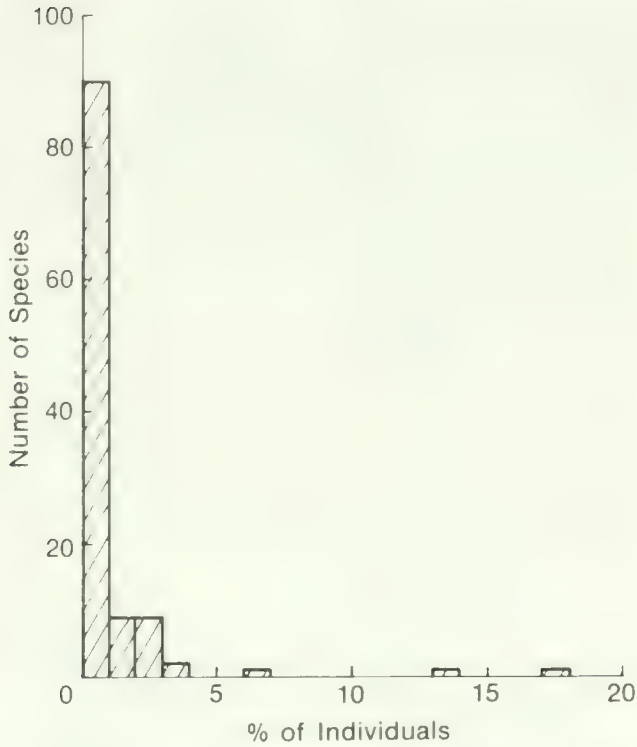

FIG. 2. Dominance histogram. Bar height represents the percent of species that account for a given percentage of individuals in the sample analyzed. For example, one species accounted for more than 17% of the individuals whereas 90% of the species each accounts for less than 1% of the individuals.

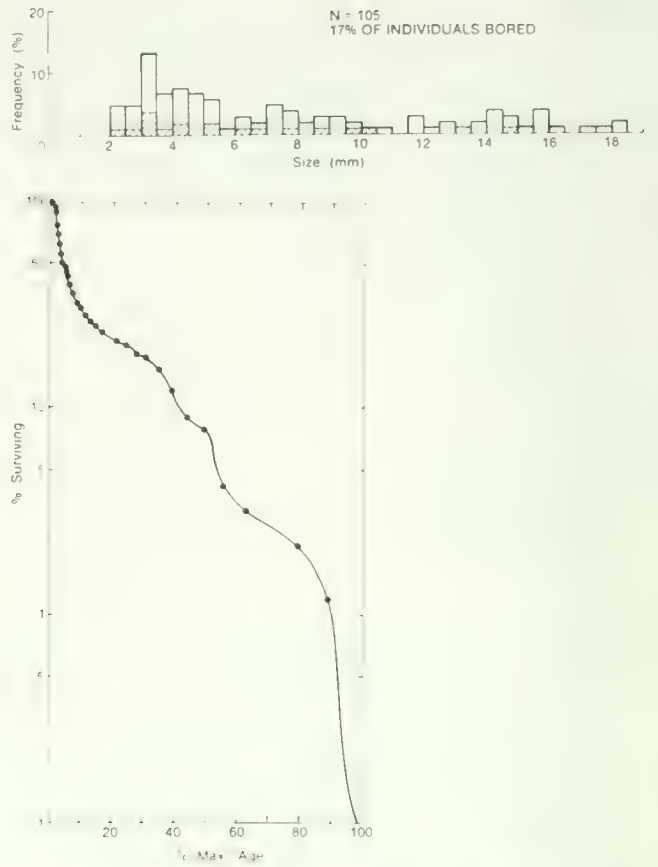

FIG. 4. Size-frequency distribution and survivorship curve for *Latirus moorei* (fascioliid gastropod).

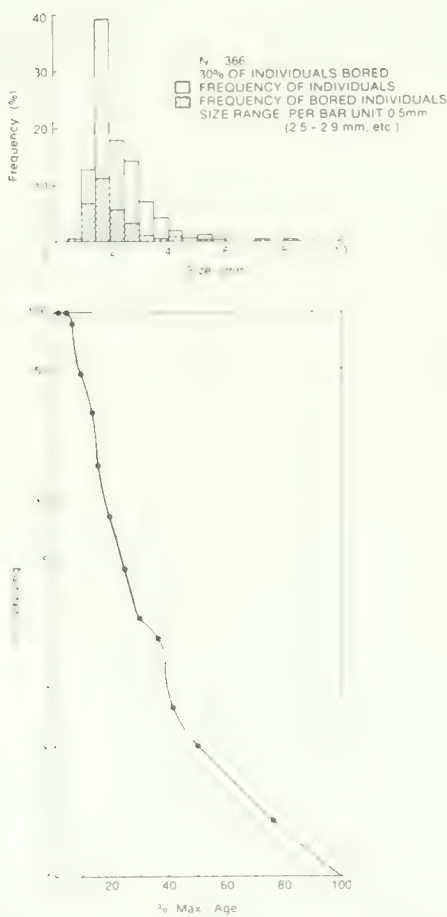

FIG. 3. Size-frequency distribution and survivorship curve for *Polinices aratus* (naticid gastropod).

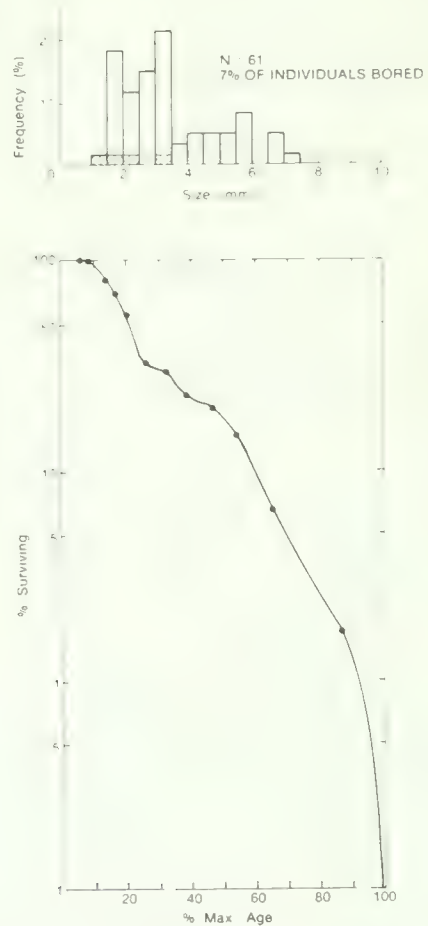

FIG. 5. Size-frequency distribution and survivorship curve for *Bonellitia parilis* (cancellariid gastropod).

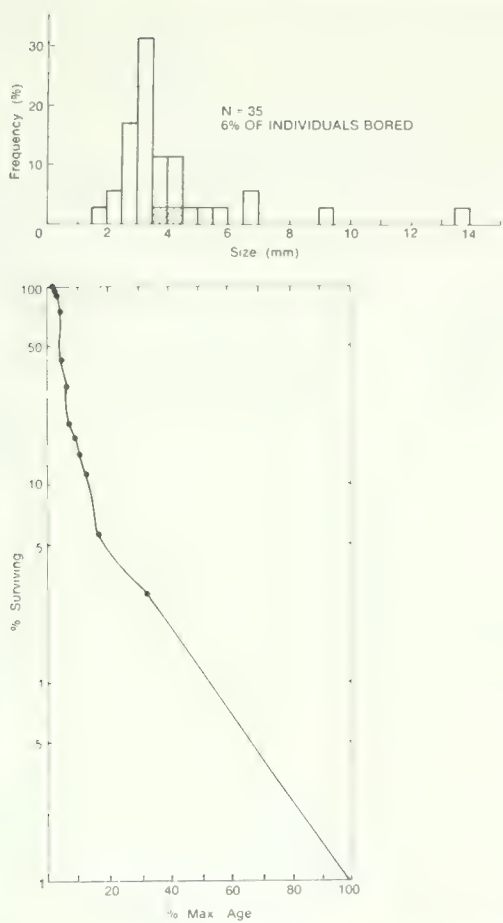

FIG. 6. Size-frequency distribution and survivorship curve for *Michela trabeatoides* (turrid gastropod).

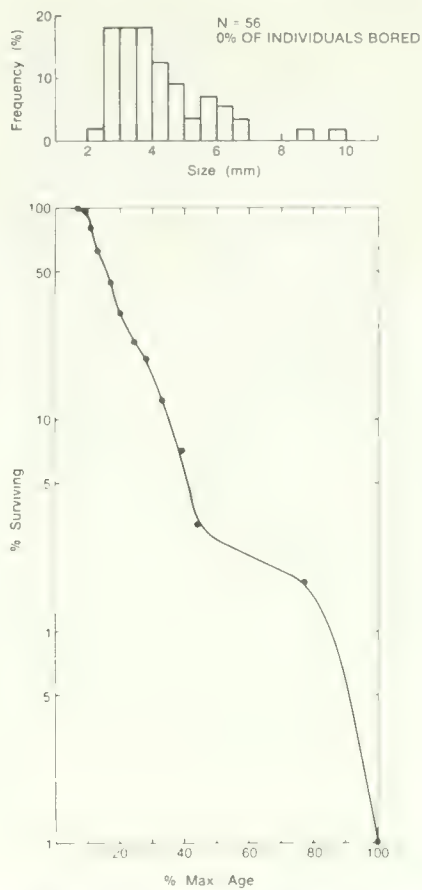

FIG. 8. Size-frequency distribution and survivorship curve for *Buccitriton sagenum* (buccinid gastropod).

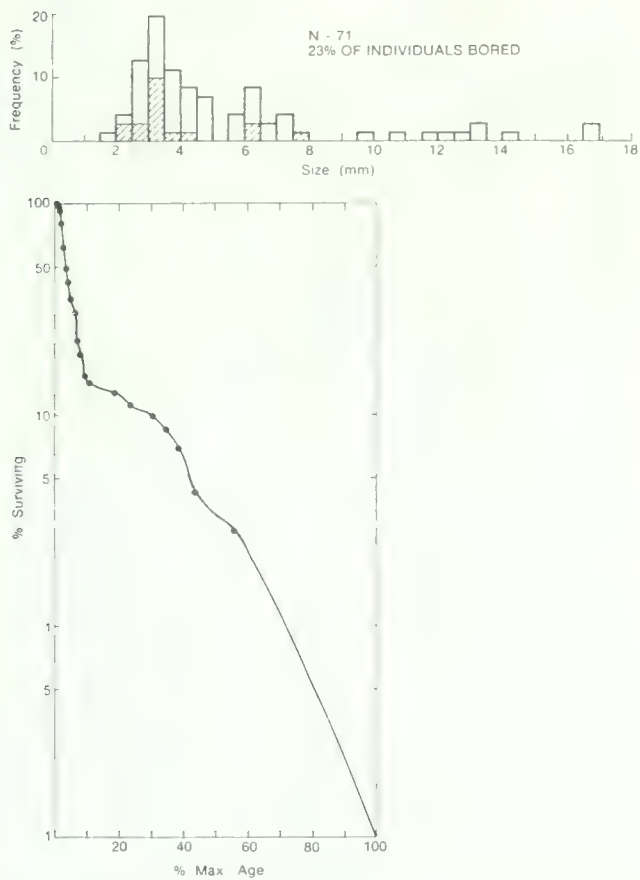

FIG. 7. Size-frequency distribution and survivorship curve for *Hesperiturris nodocarinatus* (turrid gastropod).

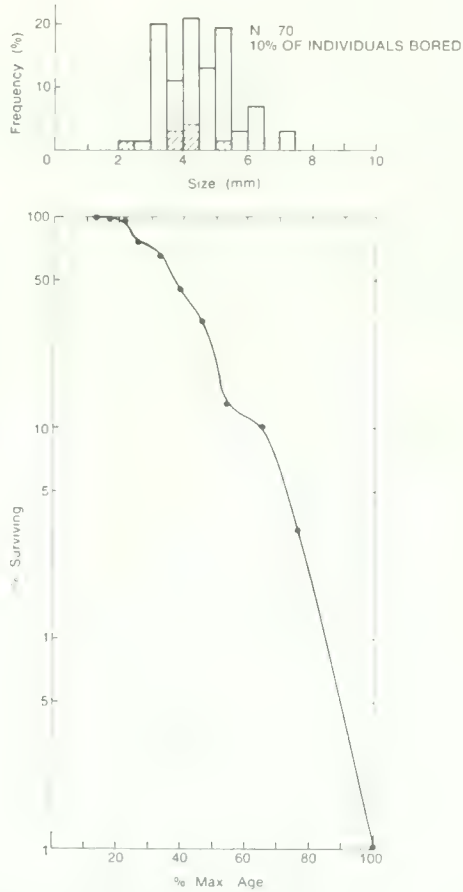

FIG. 9. Size-frequency distribution and survivorship curve for *Retusa kellogii* (retusid gastropod).

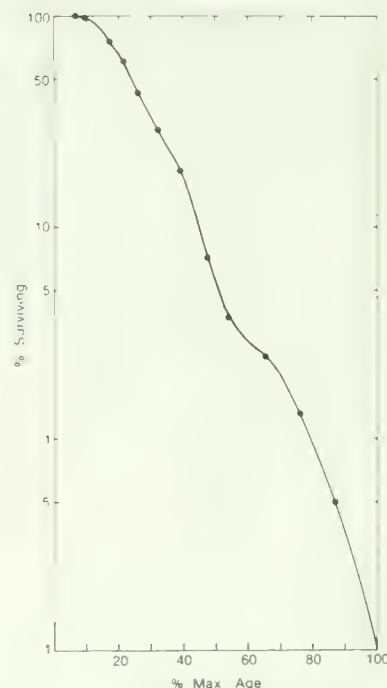
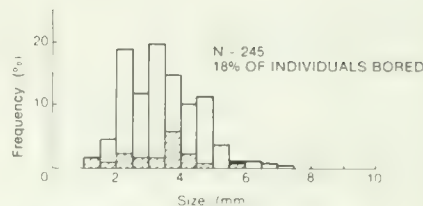
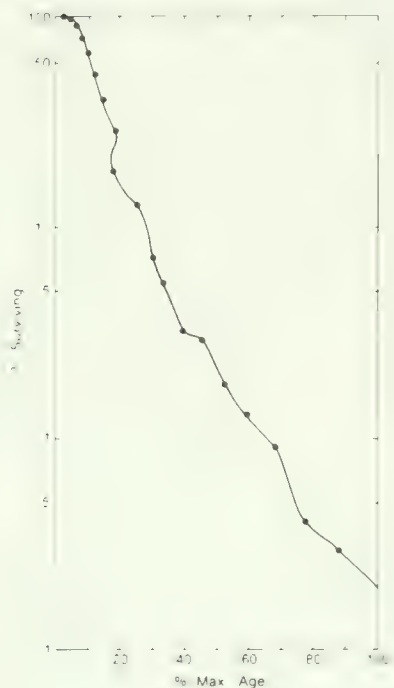
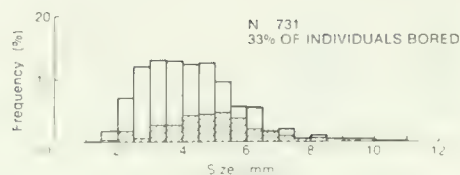

FIG. 10. Size-frequency distribution and survivorship curve for *Notocorbula texana* (corbulid bivalve).

FIG. 11. Size-frequency distribution and survivorship curve for *Vokesula smithvillensis petropolitana* (corbulid bivalve).

vidual present in the original community. It is also assumed that the death assemblage provides an accurate picture of the population dynamics of the original community (Thayer, 1977). Most of the fossils are small, with only *Conus* (Conidae) and a small percentage of the *Venericardia* (Carditidae) and *Katherinella* (Veneridae) exceeding 2.5 cm maximum length. Thus, differences in maximum size between species are not large, but differences in size-frequency distributions and survivorship curves are significant.

The food preferences of the fossils are listed in Table 1, col. 6. These are based on our own observations and on the literature for the living representatives of the fossil taxa (Fretter & Graham, 1962; Graham, 1955; and others referenced herein), and on direct evidence of predation in the fossil assemblage. Dietary information derived from living organisms is presented at the family level for two reasons. First, it is difficult to justify applying more specific modern feeding characteristics to Eocene fossils. Second, it is difficult to be more specific for a living organism because it may feed at several levels of the ecologic py-

ramid at the same time; it may feed at different levels through time, shifting its preferences with age and changing food availability; or it may have very narrow food preferences that differ from locality to locality. In addition, it is difficult to be certain that an organism is actually utilizing what it eats. For example, some amphipods consume plant detritus but derive nutritive value only from the microorganisms attached to it (Fenchel, 1970), and some molluscs may generally feed on detritus in the same way, as described, for example, by Newell (1965) for the gastropod *Hydrobia* and the bivalve *Macoma*.

Food preferences determined from direct evidence of predation are based on borings caused by gastropods and shells chipped by crustaceans. About 15% of the gastropods, bivalves, and scaphopods are bored. The taxonomic distribution and abundance of bored and chipped shells are indicated in Table 1, cols. 4 and 5, and Figs. 3-11. Based on their shape (Fretter & Graham, 1962), the borings are predominantly caused by naticid gastropods. The borings of the three most abundant species, *Polinices aratus* (13.4%),



"*Natica*" (*Naticarius*) *semilunata* (2.6%), and *Sinum bilix* (0.1%), cannot be distinguished, however. Muricids and cymatiids also bore (Owen, 1966), but are very rare in the assemblage. None of the borings can be referred to either of these groups. Rare borings similar to those made by the living *Octopus* are present and imply, although other evidence is lacking, that *Octopus* was a member of the original biocoenosis.

Mollusc shells chipped by crustaceans are abundant (Table 1, col. 5). Many prey had survived attack, for scars subsequently patched during further growth are common. None of the chipped shells in the fossil assemblage can be explained by gastropod predation, which produces a distinctive scar very different from that of crustaceans (Carriker, 1951). Many larger fossil fragments may have been the result of bioclastic breakage by

other organisms such as larger crustaceans, birds, or rays (Schäffer, 1972; Trewin & Welsh, 1976). Positive evidence of the presence of any of these organisms is otherwise lacking.

These dietary data are used to construct the ecologic pyramid (Table 1, col. 3) and the trophic web for the Eocene community (Fig. 12).

Taxa with similar trophic position are grouped together in the trophic web. Detailed information, such as the predation by naticids and crustaceans on each molluscan taxon, could be included in the web by separating out each individual genus or species. This information, however, would make the trophic web so complex that it would be unintelligible, and is available in Table 1. More importantly, these detailed interrelationships that could be included in the trophic web are speculative for

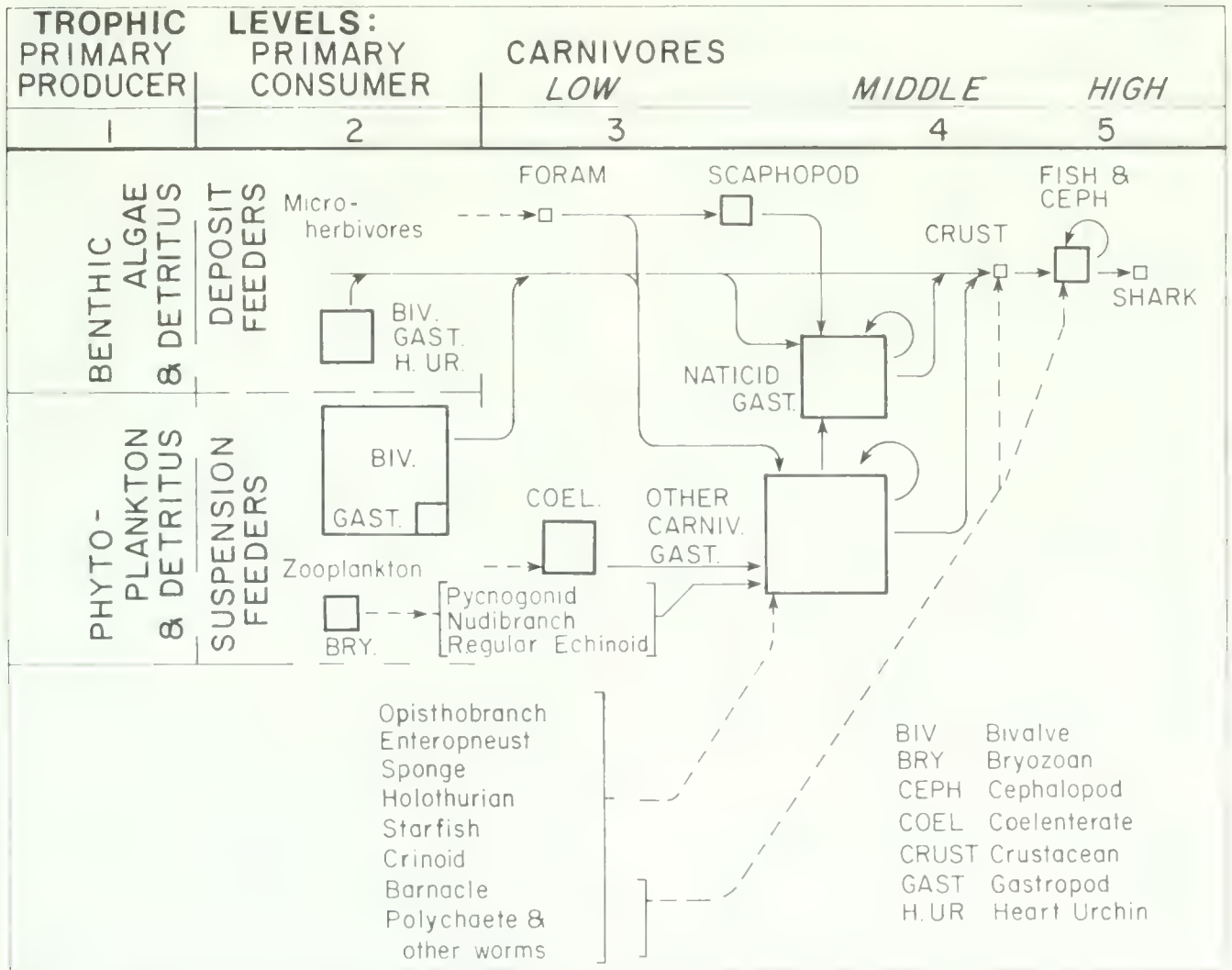

FIG. 12. Trophic web of the Main Glauconite bed community. Box sizes are proportional to numbers of individuals at each position. Solid lines and capital lettering indicate components present in the fossil assemblage and feeding relationships documented in the fossil assemblage or based on modern relationships. Dashed lines and lower case lettering indicate inferred components and relationships in the original assemblage based on modern trophic data involving components not preserved.

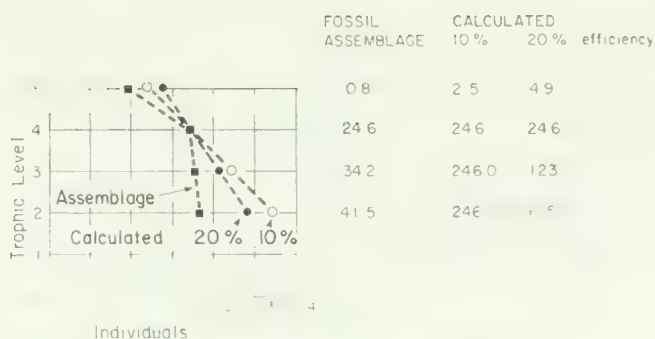

FIG. 13. Proportions of individuals at each trophic level in the ecologic pyramid based on data from Fig. 12, and those expected assuming a 10–20% transfer efficiency from one level to another with numbers in level four fixed (see text and Stanton & Nelson, 1980 for explanation).

the Eocene community because they are based on modern feeding information, which is itself incomplete. In such a detailed Eocene web based on modern data, there would be much less than meets the eye.

Because the different organisms in the original community are not equally likely to be preserved, the sizes of the boxes in Fig. 12 indicate original abundances as modified by different degrees of preservation. Several lines of evidence indicate that the effect of differential preservation may be considerable: 1) deposit feeding primary consumers are relatively rare in the fossil assemblage (the suspension feeder:deposit feeder ratio is 15.7:1), but the abundance of fecal pellets in the sediment, their nutritive value (Frankenberg & Smith, 1967), and the high degree of bioturbation suggest that the original abundance of deposit-feeding organisms must have been much greater. 2) The proportions of individuals in the fossil assemblage at different trophic levels (Fig. 13) do not agree with those expected in modern communities, with efficiency from level-to-level of 10% to 20% (Odum, 1971). Using level 4 as a reference point, carnivores are too numerous relative to primary consumers.

#### MEASURES OF TROPHIC IMPORTANCE

The trophic web (Fig. 12) is effectively the state-of-the-art for trophic analysis today. It provides the basis both for description of the taphonomic processes that have formed the fossil assemblage from the original community, and for description of the structure and evolution of ancient communities. It is imprecise, however, because it is based on

numerical abundance data. Ideally, a trophic analysis should be based on estimates of the total energy flow transmitted from one trophic level to another in the community. The importance of any prey-predator interaction must be judged by the percent of the total energy flow for which that interaction is responsible (e.g. Levine, 1980). A trophic web constructed from a fossil assemblage is inherently imprecise because of the imperfections of the fossil record. Working within that framework, however, the web can be improved by refining the numerical data to be more representative of the energy flow involved. In the following sections we will propose three approaches by which the numerical data can be improved in order to estimate energy flow.

#### Relative age distribution

The boxes in Fig. 12, representing relative numerical abundances of individuals at different positions within the trophic web, are probably a poor estimate of trophic structure because size and age distribution, as well as numbers, determine the food requirements and thus the energy flow for each species. The adult component of the population of a carnivorous gastropod is probably much more important than the juvenile component because, with increased size, the potential number, size and diversity of prey taken increase. Consequently, the number of individuals attaining adulthood should be a better estimate of relative importance of a species than the simple number of individuals. Many molluscan life strategies include the production of a large number of offspring and thus the recruitment of a large number of juveniles into the community (e.g. Thorson, 1966; Fotheringham, 1971). For a predatory species, however, subsequent high juvenile mortality would limit its role in the trophic web because the many juveniles would have consumed substantially fewer total prey than the adults, and with high juvenile mortality, the prey demand by few surviving adults would be low. In this case, numbers will over-estimate trophic importance.

The effect of age structure on food requirements of a species can be estimated from survivorship curves, such as those in Figs. 3–11 for several common species from the Main Glauconite bed. The upward concavity of the survivorship curve reflects the intensity of juvenile mortality. It is greatest, for example,

for *Michela* and *Polinices* (Figs. 6 and 3) and is least for *Bonellitia* and *Retusa* (Figs. 5 and 9). A curve with high slope at low and high values of age and with a lower slope at an intermediate age indicates high juvenile mortality but then low mortality until old age. *Buccitreron* and *Latirus* provide examples of this pattern (Figs. 8 and 4). The survivorship curve is determined by age-dependent causes of mortality. These may be parameters of the external physical environment or may be age- or size-dependent predator or prey interactions such as naticid predation, indicated by the cross-hatched bars in the size-frequency distribution plots. This predation pattern affects not only the survivorship of the prey, but also the predator in terms of prey availability. The potential usefulness of survivorship curves in paleoecology is demonstrated by recent studies by Hoffman (1976a, 1976b). Differences in the survivorship curves for the otherwise similar corbulid species of *Notocorbula* and *Vokesula* indicate that this form of analysis brings out subtle niche differences in the community.

Species with relatively low juvenile mortality, and thus with a larger proportion of the population attaining adulthood, should be relatively important in terms of biomass and energy flow in the community. The carnivorous gastropods can be ranked according to this criterion visually from the survivorship curves. In order to rank them quantitatively, the percent and number surviving to 25% and 50% of maximum age have been calculated (Table 2, cols. B and C). It is evident that although *Polinices* is very abundant, most individuals are very small, with only a few percent exceeding 25% of maximum age. In contrast, by this criterion *Retusa* and *Bonellitia* appear to be the dominant carnivorous gastropods in the community.

### Produced Biomass

Analysis of survivorship curves takes into account the age and size distribution of a population in determining the species' relative significance in the trophic web of the community. That relative significance can be expressed quantitatively by the total biomass of each predator species, because predator biomass should be proportional to the biomass of prey consumed. That is, the number of prey required to support a predator population is determined by the amount of energy input required to produce and maintain the predator

population. Thus, biomass values reflect the contributions of the different species to energy flow through the community. One way to estimate biomass values is to estimate production for each predator species from the number and size distribution of individuals in the population. Production estimates are given in Table 2, col. E for seven common predatory gastropods at Stone City. Each number is the total biovolume of individuals of a given species, less the biovolume present at minimum size (assumed to be recruitment size). The biovolumes are based on the external gastropod volume so they give overestimations of true biovolumes, but only the relative numbers are important here to indicate the relative importance of the different species. The numbers are, in effect, measures of secondary production of the predator species in the community (equivalent to G of Calow, 1977; Odum, 1971), as estimated from growth of new biomass. Conversion coefficients between biovolume and biomass are not available from the literature, but are being determined for present day snails to refine this procedure. In the meantime, biovolume provides estimates of relative production among the seven gastropods.

When the values are compared to the numerical abundance values (Table 2, col. A), it is evident that the importance of *Polinices* is significantly reduced and that of *Latirus*, the turrids, and *Retusa* is increased, as was already predicted from analysis of the survivorship curves. The locations of maximum size and of size at 50% maximum age for *Latirus moorei* and *Polinices aratus* are plotted on a single logarithmic growth curve in Fig. 14. The

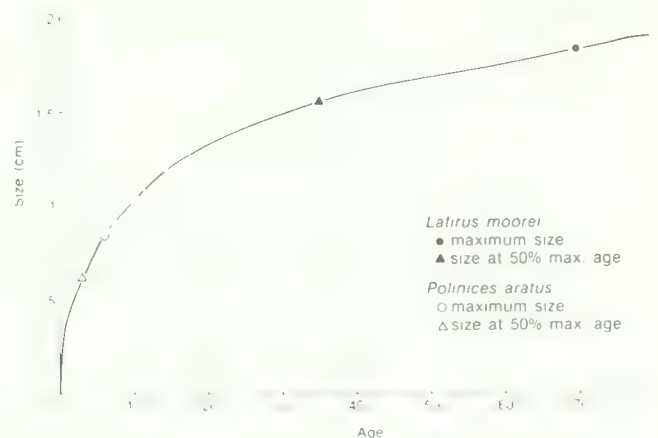

FIG. 14. Comparison of population dynamics for two species as reflected by the location of the maximum size and the size at 50% maximum age on the logarithmic growth curve.

TABLE 2. Numerical abundances, size and age data at 25% and 50% maximum age, produced biomass, and cumulative biomass for a representative sample of species in the fossil assemblage. See Text—Fig. 14 for explanation of "Relative age at 50% maximum age" in Col. D. Biomass is estimated from biovolume, calculated by treating *Retusa* as a cylinder and all other gastropods as cones, with shell length as height and maximum width as diameter.

	A		B		C		D		E	F
	Total no. of individuals	% surviving to 25% max. age	no. surviving to 25% max. age	% surviving to 50% max. age	no. surviving to 50% max. age	Size at 50% max. age (cm)	Relative age at 50% max. age	Produced biomass (as bio-volume)	Cumulative biomass (as bio-volume)	
<i>Polinices aratus</i> —(naticid)	881	4.3	38	0.5	4	.61	3.1	4.4	4.2	
<i>Retusa kellogii</i> —(acteocinid)	191	80	153	21	40	.52	2.3	2.3	3.0	
<i>Michela trabeatoides</i> —(turrid)	171	3.7	6	1.2	2	1.12	12.1	2.4	16.0	
<i>Latirus moorei</i> —(fasciolariid)	152	20	30	8	12	1.56	34.9	7.0	117.6	
<i>Hesperiturris nodocarinatus</i> —(turrid)	137	11	15	3.5	5	1.41	24.6	2.0	26.2	
<i>Bonellitia parilis</i> —(cancellariid)	113	34	40	18	20	.52	2.3	0.8	0.9	
<i>Buccitriton sagemum</i> —(buccinid)	111	22	24	2.8	3	.74	4.5	0.9	1.3	
<i>Notocorbula texana</i> —(corbulid)	1140	13	148	2	23					
<i>Vokesula smithvillensis petropolitana</i> —(corbulid)	226	47	106	6	13					

*Polinices* are small at maximum age and at 50% maximum age, with few surviving to adulthood; thus production is lower than might be expected from the number present. *Latirus* and the turrids, though fewer in number, are larger at maximum age and at 50% maximum age; thus more growth has occurred relative to numbers present. *Retusa* provides an interesting example of a species in which size at 50% maximum age is even less than in *Polinices*, but 21% of the individuals exceed this age as compared to only 0.5% of *Polinices*.

### Cumulative Biomass

The bulk of the assimilated energy of an organism will be used for growth or maintenance. Produced biomass measures energy used for growth but does not take into account the energy cost of maintenance of biomass (i.e., respiration, excretion, etc.). As a gastropod gets older, the growth efficiency declines as more and more energy is expended simply in biomass maintenance (Calow, 1977; Wilbur & Owen, 1964). Therefore, estimates of energy flow based on growth alone err in favor of the smaller or juvenile individuals, although not as badly as do the estimates based on abundance.

An analysis that includes maintenance must consider the combination of age, growth, and survivorship in order to estimate cumulative prey consumption by the carnivorous gastropod. This can be done by summing the biovolume (as an estimate of biomass) at each age unit by the number of age units present (the specimen's age). Thus, a gastropod living and growing for 3 age units might have a biomass of 1 gram at age 1, 2 at age 2 and 3 at age 3. The number used to calculate produced biomass (secondary production of the gastropod as measured by growth) would be 3 grams, but the number of grams of predator maintained by the prey population over three years is really 6. Ecologists rarely consider ecological efficiencies summed over an organism's lifespan. Paleoecologists, however, must work with long-term summed data. A specimen represents a single unit of biomass to an ecologist, and ecological inferences, even when time units are included, are nearly always as snapshots, for a point or narrow interval in time. To a paleoecologist, a specimen represents an individual that lived and grew and was part of a community during a span of time. Thus, the value 6, the cumula-

tive biomass, estimates maintenance requirements such as energy lost by respiration and excretion during the animal's lifespan, whereas produced biomass represents the standing crop. Values of cumulative biomass, estimates from cumulative volume, are listed in Table 2, col. F. These values should be considered in relative magnitude of values and importance of species within a column, and their differences in ranking between columns.

### Comparison of estimates

These three approaches give very different, and we believe better, estimates of the roles of the carnivorous gastropods than do abundance values. They depend on several assumptions associated with the survivorship curves: (1) Conversion of size to age is based on a general logarithmic relationship between the two. Only rarely can age be determined directly from shell form or microstructure. (2) Comparison of different species is based on the assumption that the age-growth relationship is similar for each (as in Fig. 14). This assumption is only approximate (Hallam, 1967), and maximum age and size data for Recent taxa are sorely needed to calibrate the age-growth relationships (e.g. Comfort, 1957; Green, 1979). (3) Survivorship curves and age determinations are based on length measurements, but biomass would be more precise. The use of length measurements introduces errors to the extent that the length/biomass ratio changes as shell form, and particularly rates of whorl expansion and whorl translation, change with size. (4) Minimum age is assumed to be size 0, but for some organisms recruitment size may be substantial. (5) The largest specimen collected is assumed to be representative of the maximum size (and maximum age) of the species. Data from the literature, though sparse, support this in all cases except *Michela* and *Buccitriton* (see Palmer, 1937; Harris, 1937; Gardner, 1945, for size data). In these two taxa, our largest specimens are approximately 50% actual maximum sizes as reported in the literature. The percent maximum age, as used here, refers only to percent maximum age at Stone City. (6) Size differences due to sexual dimorphism are not present. (7) The specimens in the fossil assemblage reflect the actual size-frequency distributions present in the living community. Recent data for living gastropods are insufficient to test these assumptions. We believe that

only assumptions 2 and 3 may be sufficiently questionable to introduce significant error into the analysis.

Numerical abundance (Table 2, col. A) considers only the number of individuals. In this ranking, *Polinices* is clearly the dominant gastropod in the community. Survivorship (Table 2, col. B and C) considers the relative abundance during adulthood rather than total abundance. This suggests that *Polinices* is much less important and that *Retusa*, *Bonellitia*, and *Latirus* are relatively more important in the trophic web relative to estimates based on numerical abundance alone. Size frequency-survivorship data are imperfect measures of energy flow, however. The longer-lived and larger organisms, *Latirus* and the two turrids in particular, maintain a larger biomass than the others, and, all else being equal, can be expected to consume many more prey over their lifespans than the other gastropods. A species' contribution to total energy flow in the community and, therefore, its importance in the trophic web can be best understood by using estimates of produced biomass (Table 2, col. E) and cumulative biomass (Table 2, col. F), which are estimates of the energy required for growth and maintenance by the animals over their lifespans.

The size and relative age at 50% maximum age (Table 2, col. D; Fig. 14) of these gastropods indicate that substantial differences are to be expected in the energy required for growth and maintenance. Estimates of produced biomass indicate that *Polinices*, *Retusa*, the turrids, and *Latirus* account for the bulk of the secondary production by predators. *Polinices*, though most abundant, is responsible for less secondary production than *Latirus* and no more than about twice that of *Retusa* and the turrids. If energy used for maintenance of biomass is also considered, using cumulative biomass, *Polinices* is relatively insignificant, whereas the turrids and *Latirus* are extremely important for energy flow in the community.

The produced biomass and cumulative biomass data are not directly comparable, unfortunately, because neither is in energy units. Thus it is not possible to combine the two and arrive at the best estimate of total energy flow for these species. If biovolume to biomass conversion coefficients were available and if metabolic data for modern analogous species were known, both estimates could be converted into energy terms. Produced biomass values could be converted using a biomass-

to-energy conversion for typical protoplasm (Odum, 1971). Cumulative biomass would require the use of the relationship  $M = kW^b$  with  $k$  being obtained from respiration values for recent analogues (see Prosser, 1973),  $M$  being metabolic rate expressed in Kcal/time unit, where the time unit would be the individual's life span, and  $W$  being the cumulative biomass maintained by the individual over its lifespan. Food input (i.e., grams of prey consumed) could then be estimated because energetic costs of growth and maintenance could be derived directly from the fossil assemblage, and estimates of assimilation and growth efficiencies could be obtained from recent analogues (e.g. Calow, 1977). Metabolic rate has been calculated for extinct mammals using this procedure (Martin, 1980).

A rough test of the quality of the estimates of produced and cumulative biomass can be made using the naticids, because in this case both prey and predator can be counted. Molluscan prey were consumed primarily by crabs and gastropods. Crabs accounted for roughly 20% of the molluscs preyed upon (Stanton & Nelson, 1980). Naticid borings occur in about 15% of all individuals (bivalves, scaphopods, and gastropods) at Stone City. Thus, of the molluscs escaping crab predation, about 20% succumbed to naticid predators. If all borings were successful (i.e., predation efficiency = 100%), then as much as 20% of the molluscan biomass was naticid prey.

Even the largest naticids are small, however. The size distributions of borings in the gastropods (Figs. 3-11) indicate that the larger individuals effectively escaped naticid predation. This is particularly clear for the three largest gastropods, *Latirus*, *Hesperiturris*, and *Michela*, in which boring incidence in individuals of size greater than 0.6-1.0 cm is low. Because their prey were smaller than average, it is safe to assume that naticids consumed less than 20% of the molluscan biomass produced at Stone City.

If we assume that most molluscan mortality was caused by predation and that *Polinices*, *Latirus*, and *Buccitriton* comprised the bulk of the molluscan predators, the percent of molluscan prey each consumed should roughly equal the percent that each comprised of the total produced biomass and cumulative biomass of molluscan predators at Stone City. For *Polinices*, the percentages are 36% and 3% for produced biomass and cumulative biomass, respectively. If the two biomass esti-

mates were combined, the actual percentage would be somewhere in between. Considering the roughness of the estimates and the assumptions involved, this agrees reasonably well with the estimate of somewhat less than 20% of molluscan biomass consumed by the naticids. Thus the estimates of energy flow presented here appear to be sufficiently precise to be useful in reconstructing the trophic web of this community.

### INTERPRETATION

None of the primary producers (level 1) of the original community is preserved in the fossil assemblage. The preserved primary consumers (level 2) are largely suspension-feeding bivalves and bryozoans. The exact composition of their diet is unknown but is largely phytoplankton for living members of these taxa. The role of detritus is unclear for it may have served as food directly, or as food for the bacteria and fungi that are used as food at this level. Pollen, spores, and diatoms may have been present but probably would have comprised only a minor part of the original primary food source. None of the primary consumers in the community fed on benthic macrophytes, and organisms that might have been epizoans on such plants are absent from the fauna. Thus, larger plants were probably uncommon or absent.

The fact that the important preserved primary consumers are suspension-feeding bivalves is no more surprising than the fact that the important preserved predators are gastropods. The dominant preservable organisms in most present-day communities are molluscs. Of these, the bivalves are largely suspension feeders and the higher prosobranch gastropods are largely carnivores. Most other hard-bodied organisms are either suspension feeders or carnivores (e.g., bryozoans, brachiopods, corals, etc.). In contrast, most deposit feeders are soft-bodied and not preserved.

In many communities today, suspension-feeding bivalves and carnivorous gastropods are much less numerous than soft-bodied organisms such as polychaetes and amphipods, and so are not numerical dominants (e.g., Frankenberg, 1971; Boesch, 1973; Maurer, 1977). Thus, almost all fossil assemblages will consist of suspension feeders and carnivores regardless of the species composition and of the trophic structure of the

original community, and a trophic web based solely on numerical abundances of preserved organisms will present a poor picture of the original community. Trophic analysis in paleontology must attempt to identify differences in the original communities from subtle differences within the biased records of the fossil assemblages. The prediction of prey-item abundance, based on the estimates of energy flow and population dynamics of the predators, is one potentially valuable tool.

In the Stone City assemblage, *Polinices* appears to have been a dominant predator based on its numerical abundance. This was unlikely, however, because the *Polinices* individuals were cannibalistic and were predominantly very small, with many fewer of them reaching 50% maximum age (0.5%) than other gastropods in the community. The high juvenile mortality of *Polinices* may have been caused by recruitment into a sub-optimal environment, because naticids today are typically found in sandier, higher-energy habitats than that of the Stone City Formation (Hunter & Grant, 1966; Kinner et al., 1974; Franz, 1976). Survivorship to 50% maximum age was much greater for the gastropods *Retusa* and *Bonellitia*, but their small size and short lifespan limited their contribution to energy flow in the community.

Survivorship curves scaled to percent of maximum age may be misleading because maximum age may be significantly different for the various species. For example, few individuals of either *Hesperiturris* or *Polinices* lived to 50% maximum age, but if growth rates of the two were similar, the maximum age of *Hesperiturris* would have been much greater than that of *Polinices*, and individuals of *Hesperiturris* would have existed in the community over a longer period of time than individuals of *Polinices*. Thus, the high juvenile mortality suggested by the two survivorship curves for turrids probably occurred over a real time span significantly greater than the juvenile mortality of *Polinices*. Consequently, *Michela* and *Hesperiturris*, and to a lesser extent *Retusa*, were important predators. Few of the turrids survived to 50% maximum age, but the size at this age is so large that the produced biomass and cumulative biomass are large. Moreover, the total number of turrid genera and species at Stone City is large. Although a large percent of individuals of *Bonellitia* and *Retusa* survived to 50% maximum age, the individuals were small and probably had a short lifespan (about one year for

*Retusa*; Smith, 1967). Thus, they probably had a limited role in the energy flow within the community. Prey items for *Retusa* probably included other molluscs among the preserved component as well as some soft-bodied animals (Smith, 1967). Prey items for the turrids were primarily soft-bodied (Fretter & Graham, 1962) and therefore not preserved.

The fascioliid, *Latirus*, appears to have been the dominant predator. Present day fascioliids prey primarily on molluscs (Wells, 1958), and if *Latirus* did likewise, it must have been one of the primary predators on the preserved component, the molluscs, at Stone City, including many other carnivorous gastropods. Judging from the abundance of crab-nipped shells, crabs were also important predators of molluscs (see also Virnstein, 1977), and the *Polinices*-molluscan prey link was third in importance.

The ecologic pyramid based on the preserved component (Fig. 13) indicates that a large part of the original Stone City community was not preserved. The amount, however, is difficult to determine. A comparison of produced biomass and cumulative biomass for *Latirus* and *Polinices*, which fed on preserved prey, and the two turrids measured which fed on non-preserved prey, suggests that at least  $\frac{1}{4}$  to  $\frac{1}{3}$  of all prey biomass was not preserved. If the other species of turrids (turrids comprise  $\frac{1}{4}$  of all Stone City gastropods) have similar size-frequency distributions, the estimated percentage of soft-bodied prey increases to at least one half.

It is important to recognize that trophic analysis of fossil assemblages is inherently biased toward the preservable components. Predator-prey links among preservable organisms are preserved, and some predator-prey links between preserved and non-preserved organisms can be reconstructed. However, the importance of predator-prey links between non-preserved organisms can almost never be estimated, although they are of great importance in modern communities. Thus the estimate that one-half of the prey biomass is non-preserved, based on information retained in the fossil record, must be a minimum. In all likelihood, the Stone City community was dominated by non-preserved organisms both numerically and in biomass. There are several other pieces of evidence which support this contention: 1. Crab predation was important. Crabs feed on both the preservable and non-preserved component today (Virnstein, 1977) and probably

also did in the Eocene. 2. The sediment is pelleted and bioturbated. Those responsible were most probably soft-bodied deposit feeders. 3. Present day soft-bottom communities are rarely dominated by gastropods as is the assemblage in the Stone City formation—rarely does any carnivorous gastropod make up 1% or more of the total individuals present (for example, Frankenberg, 1971; Maurer, 1977; Sanders, 1958; Sanders et al., 1962; and many others). This is not unexpected since a carnivorous trophic position requires that the animal be relatively rare. Because the gastropods are even more common than the bivalves at Stone City, it is reasonable to expect that the entire preserved component was a small fraction of the living community. The bivalves are at a lower trophic position than the gastropods and so might be expected to be much more common. That they are not suggests that they, too, were not numerical dominants. 4. Dominant predators feeding on molluscs are limited to the fascioliid, naticids, and the few buccinids. Based on numerical abundance, 45% of the gastropods fed on soft-bodied prey and 47% on molluscs, but 70% of the latter are naticids. If molluscs were really a major component, mollusc-feeding predators would be expected to be more abundant.

The Stone City community was predominantly composed of soft-bodied organisms; preservable organisms probably made up less than one-half of the biomass; the trophic web contained primarily soft-bodied prey and both preserved and non-preserved predators, with the well preserved molluscan predator-prey links playing a subordinate role in the entire community. These conclusions are consistent with recent studies on the preservability of organisms in Recent communities.

## DISCUSSION

Trophic analysis can be a powerful tool in reconstructing the original community. It is more useful than trace fossils in determining the non-preserved component of the biota because bioturbation is caused by processes operating at a different time scale than the accumulation of body fossils. For example, in heavily bioturbated areas, the sediment may be completely reworked once or more within the lifespan of the preservable organisms present (e.g., Powell, 1977, and references therein). Thus, the number of times the sedi-



ment is reworked is not preserved, and estimation of the relative standing crop of deposit feeders is not possible. Trophic analysis, however, uses the preservable component to estimate the non-preservable, and because they are bound together trophically, their interactions are likely to be within the same time frame. Thus, estimation of relative composition should be possible, yielding a much more complete reconstruction of the community.

Trophic analysis, even at this primitive level, can be a useful tool in identifying and estimating the role of the non-preservable component in the fossil community. The basic assumptions, however, as described earlier, need to be evaluated in recent communities, even though the trophic analysis of a fossil community can never be exactly comparable to that of a Recent community. The ecologist can deal with the community in space and time as the faunal composition varies over periods of months to a few years (e.g., Buchanan et al., 1974; Davis & VanBlaricom, 1978; Poore & Rainer, 1979). In effect, he can integrate a number of separate snapshots of the community over time. On the other hand, the paleoecologist can never recognize or quantify short-term fluctuations of this type in a time-averaged fossil assemblage (Peterson, 1977). Preservation acts as a low-pass filter, passing through only the long-term changes and filtering out the short-term community changes in species composition and in abundance and size of individuals, which continuously modify the trophic web. Within the "noise" of short-term fluctuations are also disturbance-related phenomena which may have had profound effects on species composition and trophic structure. The fossil record preserves the integrated average, upon which paleoecological trophic theory must be based. Ecological theory rarely, if ever, addresses phenomena on this time scale.

The analysis of the Stone City fossil assemblage suggests that the paleoecologist's ability to reconstruct a community trophically, based on the assumption that the fossil assemblage can be treated as a snapshot, is relatively far advanced. Our ability to interpret the data contained in the analysis of energy flow phenomena—survivorship curves and size frequency distributions, for example—is inhibited primarily by the paucity of data available for modern communities. These data can be acquired, however, so much progress can be expected in the future. On the other hand,

it is the assumption that the community can indeed be treated as a snapshot that needs careful consideration. Here paleoecologic theory (and ecological theory) is not sufficiently far advanced. It is here that work must be done in recent communities to determine how to take the short-term noisy ecologic record and adapt it to the long-term picture needed for paleoecologic trophic analysis. Multiple stable points (Gray, 1977), disturbances (Woodin, 1978), and periodic invasions of explosive opportunistic species (Levinton, 1970; Grassle & Grassle, 1974) all frequently occur in modern communities. The time scales, however, are within the time-determined noise level of paleoecology. In some cases phenomena such as opportunistic incursions may be recognized, and the naticids at Stone City may well represent an example. It is probably not generally possible to quantify and subtract out these phenomena, however, so community reconstruction will always yield a "filtered" community, and paleoecological trophic theory must be based on the long-term averaged picture.

#### ACKNOWLEDGMENTS

We thank Sayed El-Sayed and Stefan Gartner for their suggestions, which improved the manuscript.

#### REFERENCES CITED

- BOESCH, D., 1973, Classification and community structure of macrobenthos in the Hampton Roads area, Virginia. *Marine Biology*, 21: 226–244.
- BOSENCE, D., 1979, Live and dead faunas from coralline algal gravels, Co. Galway. *Palaeontology*, 22: 449–478.
- BUCHANAN, J., KINGSTON, P. & SHAEDE, M., 1974, Long-term population trends of the benthic macrofauna in the offshore mud of the Northumberland coast. *Journal of the Marine Biological Association of the United Kingdom*, 54: 785–795.
- CALOW, P., 1977, Conversion efficiencies in heterotrophic organisms. *Biological Reviews*, 52: 385–409.
- CARRIKER, M. R., 1951, Observations on the penetration of tightly closing bivalves by *Busycon* and other predators. *Ecology*, 32: 73–83.
- COMFORT, A., 1957, The duration of life in molluscs. *Proceedings of the Malacological Society of London*, 32: 219–241.

- DAVIS, N. & VANBLARICOM, G. R., 1978, Spatial and temporal heterogeneity in a sand bottom epifaunal community of invertebrates in shallow water. *Limnology and Oceanography*, 23: 417-427.
- FENCHEL, T., 1970, Studies on the decomposition of organic detritus derived from the turtle grass *Thalassia testudinum*. *Limnology and Oceanography*, 15: 14-20.
- FOTHERINGHAM, N., 1971, Life history patterns of the littoral gastropods *Shaskyus festivus* (Hinds) and *Ocenebra poulsoni* Carpenter (Prosobranchia: Muricidae). *Ecology*, 52: 742-757.
- FRANKENBERG, D., 1971, The dynamics of benthic communities off Georgia, U.S.A. *Thalassia Jugoslavica*, 7: 49-55.
- FRANKENBERG, D. & SMITH, K. L., 1967, Coprophagy in marine animals. *Limnology and Oceanography*, 12: 443-450.
- FRANZ, D., 1976, Benthic molluscan assemblages in relation to sediment gradients in northeastern Long Island Sound, Connecticut. *Malacologia*, 15: 377-399.
- FRETTER, V. & GRAHAM, A., 1962, *British Prosobranch Molluscs*. Ray Society, London, 755 p.
- GARDNER, J., 1945, Mollusca of the Tertiary formations of northeastern Mexico. *Geological Society of America Memoir*, 11: 1-332.
- GRAHAM, A., 1955, Molluscan diets. *Proceedings of the Malacological Society of London*, 31: 144-159.
- GRASSLE, J. & GRASSLE, J., 1974, Opportunistic life histories and genetic systems in marine benthic polychaetes. *Journal of Marine Research*, 32: 253-284.
- GRAY, J. S., 1977, The stability of benthic ecosystems. *Helgoländer wissenschaftliche Meeresuntersuchungen*, 30: 427-444.
- GREEN, R., 1979, Matrix population models applied to living populations and death assemblages. *American Journal of Science*, 279: 481-487.
- GREENFIELD, L. L., 1957, *Stratigraphy and micropaleontology of the Cook Mountain Formation, western Fayette County, Texas*. Unpubl. M.A. thesis, University of Texas, 71 p.
- HALLAM, A., 1967, The interpretation of size-frequency distributions in molluscan death assemblages. *Palaeontology*, 10: 25-42.
- HARRIS, G., 1937, Turrid illustrations, mainly Claibornian. *Paleontographica Americana*, 2(7): 1-96.
- HOFFMAN, A., 1976a, Mortality patterns of some gastropods from the Badenian (Miocene) Korytnica Clays, Poland. *Neues Jahrbuch für Geologie und Paläontologie; Abhandlungen*, 152: 293-306.
- HOFFMAN, A., 1976b, Mortality patterns of some bivalves from the Badenian (Miocene) Korytnica Clays, Poland. *Neues Jahrbuch für Geologie und Paläontologie; Monatshefte*, 1976(6): 337-349.
- HOFFMAN, A., PISERA, A. & STUDENCKI, W., 1978, Reconstruction of a Miocene kelp-associated macrobenthic ecosystem. *Acta Geologica Polonica*, 28: 377-387.
- HOLLAND, J., MACIOLEK, N. & OPPENHEIMER, C., 1973, Galveston Bay benthic community structure as an indicator of water quality. *Contributions in Marine Science*, 17: 169-188.
- HUNTER, W. & GRANT, D., 1966, Estimates of population density and dispersal in the naticid gastropod, *Polinices duplicatus*, with a discussion of computational methods. *Biological Bulletin*, 131: 292-307.
- KINNER, P., MAURER, D. & LEATHEM, W., 1974, Benthic invertebrates in Delaware Bay: animal-sediment associations of the dominant species. *Internationale Revue der gesamten Hydrobiologie*, 59: 685-701.
- LAWRENCE, D. R., 1968, Taphonomy and information losses in fossil communities. *Geological Society of America Bulletin*, 79: 1315-1330.
- LEVINE, S., 1980, Several measures of trophic structure applicable to complex food webs. *Journal of Theoretical Biology*, 83: 195-207.
- LEVINTON, J., 1970, The paleoecological significance of opportunistic species. *Lethaia*, 3: 69-78.
- LEVINTON, J. & BAMBACH, R., 1969, Some ecological aspects of bivalve mortality patterns. *American Journal of Science*, 268: 97-112.
- MARTIN, R. A., 1980, Body mass and basal metabolism of extinct mammals. *Comparative Biochemistry and Physiology*, 66A: 307-314.
- MAURER, D., 1977, Estuarine benthic invertebrates of Indian River and Rehoboth Bays, Delaware. *Internationale Revue der gesamten Hydrobiologie*, 62: 591-629.
- MYERS, A., 1977a, Sediment processing in a marine subtidal sandy bottom community: I. Physical aspects. *Journal of Marine Research*, 35: 609-632.
- MYERS, A., 1977b, Sediment processing in a marine subtidal sandy bottom community: II. Biological consequences. *Journal of Marine Research*, 35: 633-647.
- NEWELL, R., 1965, The role of detritus in the nutrition of two marine deposit feeders, the prosobranch *Hydrobia ulvae* and the bivalve *Macoma balthica*. *Proceedings of the Zoological Society of London*, 144: 25-45.
- ODUM, E., 1971, *Fundamentals of Ecology*, ed. 3, Saunders, Philadelphia, 574 p.
- OWEN, G., 1966, Feeding. In WILBUR, K. M. & YONGE, C. M. (eds.), *Physiology of Mollusca II*, Academic Press, New York, 1-51.
- PALMER, K. V., 1937, The Claibornian Scaphopoda, Gastropoda, and dibranchiate Cephalopoda of the southern United States. *Bulletins of American Paleontology*, 7: 1-548.
- PETERSON, C., 1977, The paleoecological significance of undetected short-term temporal variability. *Journal of Paleontology*, 51: 976-981.
- POORE, G. & RAINER, S., 1979, A three year study of benthos of muddy environments in Port

- Phillip Bay, Victoria. *Estuarine and Coastal Marine Science*, 9: 477–497.
- POWELL, E. N., 1977, Particle size selection and sediment reworking in a funnel feeder, *Leptosynapta tenuis* (Holothuroidea, Synaptidae). *Internationale Revue der gesamten Hydrobiologie*, 62: 385–408.
- PROSSER, C. L., 1973, *Comparative Animal Physiology*, ed. 3, Saunders, Philadelphia, 966 p.
- SANDERS, H. L., 1958, Benthic studies in Buzzards Bay. I. Animal-sediment relationships. *Limnology and Oceanography*, 3: 245–248.
- SANDERS, H. L., GOUDSMIT, E. M., MILLS, E. L. & HAMPSON, G. E., 1962, A study of the intertidal fauna of Barnstable Harbor, Massachusetts. *Limnology and Oceanography*, 7: 63–79.
- SCHÄFER, W., 1972, *Ecology and Paleocology of Marine Environments*. University of Chicago, Chicago, Illinois, 568 p.
- SCHOPF, T., 1978, Fossilization potential of an intertidal fauna. Friday Harbor, Washington. *Paleobiology*, 4: 261–270.
- SCOTT, R. W., 1978, Approaches to trophic analysis of paleo-communities. *Lethaia*, 11: 1–14.
- SMITH, S., 1967, The ecology and life history of *Retusa obtusa* (Montagu) (Gastropoda, Opisthobranchia). *Canadian Journal of Zoology*, 45: 397–405.
- STANTON, R. J., Jr., 1976, The relationship of fossil communities to the original communities of living organisms. In SCOTT, R. W. & WEST, R. R. (eds.), *Structure and Classification of Paleo-communities*, Dowden, Hutchinson and Ross, Stroudsburg, Pa., 107–142.
- STANTON, R. J., Jr., 1979, The Stone City Formation. In KERSEY, D. G. (ed.), *Claiborne sediments of the Brazos Valley, Southeast Texas*. Houston Geological Society Guidebook, 73–77.
- STANTON, R. J., Jr. & DODD, J. R., 1976, The application of trophic structure of fossil communities in paleoenvironmental reconstruction. *Lethaia*, 9: 327–342.
- STANTON, R. J., Jr. & NELSON, P. C., 1980, Reconstruction of the trophic web in paleontology: Community structure in the Stone City Formation (Middle Eocene, Texas). *Journal of Paleontology*, 54: 118–135.
- STANTON, R. J., Jr. & WARME, J. E., 1971, Stop 1: Stone City Bluff. In PERKINS, B. F. (ed.), *Trace Fossils, a Field Guide to selected localities in Pennsylvanian, Permian, Cretaceous and Tertiary rocks of Texas and related Papers*. School of Geoscience, Louisiana State University Miscellaneous Publication, 71–1, p. 3–10.
- STENZEL, H. B., KRAUSE, E. K. & TWINING, J. T., 1957, Pelecypods from the type locality of the Stone City beds (Middle Eocene) of Texas. *University of Texas Publication*, 5704: 1–237.
- THAYER, C., 1977, Recruitment, growth, and mortality of a living articulate brachiopod with implications for the interpretation of survivorship curves. *Paleobiology*, 3: 98–109.
- THORSON, G., 1966, Some factors influencing the recruitment and establishment of marine benthic communities. *Netherlands Journal of Sea Research*, 3: 267–293.
- TREWIN, N. H. & WELSH, W., 1976, Formation and composition of a graded estuarine shell bed. *Palaeogeography, Palaeoclimatology, Palaeoecology*, 19: 219–230.
- VIRNSTEIN, R. W., 1977, The importance of predation by crabs and fishes on benthic infauna in Chesapeake Bay. *Ecology*, 58: 1199–1217.
- VIRNSTEIN, R. W., 1979, Predation on estuarine infauna: response patterns of component species. *Estuaries*, 2: 69–86.
- WALKER, K. R., 1972, Trophic analysis: a method for studying the function of ancient communities. *Journal of Paleontology*, 46: 82–93.
- WALKER, K. & BAMBACH, R., 1974, Feeding by benthic invertebrates: classification and terminology for paleoecological analysis. *Lethaia*, 7: 67–78.
- WELLS, H., 1958, Predation of pelecypods and gastropods by *Fasciolaria hunteria* (Perry). *Bulletin of Marine Science of the Gulf and Caribbean*, 8: 152–166.
- WILBUR, K. M. & OWEN, G., 1964, Growth. In WILBUR, K. M. & YONGE, C. M. (eds.), *Physiology of Mollusca I*, Academic Press, New York, p. 211–242.
- WILSON, W. H., Jr., 1979, Community structure and species diversity of the sedimentary reefs constructed by *Petaloproctus socialis* (Polychaeta: Maldanidae). *Journal of Marine Research*, 37: 623–664.
- WOODIN, S. A., 1978, Refuges, disturbance, and community structure: a marine soft-bottom example. *Ecology*, 59: 274–284.
- YOUNG, D. K. & RHOADS, D. C., 1971, Animal sediment relations in Cape Cod Bay, Massachusetts. I: a transect study. *Marine Biology*, 11: 242–254.



INDEX TO SCIENTIFIC NAMES IN VOLUME 20, NOS. 1–2

An asterisk (\*) denotes a new taxon

- abidjanense*, *Chaetoderma*, 362, 372  
*Acanthaster*, 391, 392  
*Acanthina*, 405, 408, 411, 415  
*Acanthodoris*, 440–442, 444  
*achaeus*, *Anomia*, 147  
*acicularis*, *Cypraea*, 346  
*aciculata*, *Mazatlanina*, 312, 313, 346  
*aciculata*, *Ocenebra*, 414  
*Acmaea*, 292, 300  
*Acmaeidae*, 291–305  
*acra*, *Fusiturricula*, 311, 338–340  
*acra*, *Pleurofusua*, 338  
*Acteocinidae*, 454, 462  
*Actiniaria*, 442, 444  
*Actinonaias*, 219, 229, 234  
*aculeata*, *Anomia*, 149  
*Adapedonta*, 224  
*adpersa*, *Tenellia*, 441, 443, 447  
*Adulomya*, 164, 185  
*aegrota*, *Dicathais*, 409  
*Aeolidacea*, 439, 441, 442, 444, 446, 448  
*Aeolidia*, 99–116, 441–445  
*Aeolidiella*, 112, 201, 202, 441–445  
*Aeolidiidae*, 441  
*Aeolidoidea*, 112  
*affinis*, *Cardita*, 163  
*Aforia*, 425  
*Agatrix*, 311–313, 332, 333  
*Agladrillia*, 307, 311, 335, 338, 425  
*akanudaensis*, *Calyptogena*, 185  
*Akebiconcha*, 162, 163, 185, 186, 188, 189  
*Alasmidonta*, 219, 234, 237, 243, 245, 251  
*Alasmidontinae*, 234, 249, 250, 253  
*alata*, *Proptera*, 219, 221, 226  
*albanyensis*, *Goniobasis*, 64, 65, 67, 68, 70, 71, 76  
*albida*, *Turris*, 337  
*albidum*, *Epitonium*, 346  
*albocrusta*, *Cuthona*, 447  
*albolaqueata*, *Calliclava*, 424  
*albus*, *Dendronotus*, 441, 443  
*Alcyonacea*, 445, 448  
*Alcyonaria*, 454  
*alderi*, *Aeolidiella*, 201, 202  
*alesidota*, *Hindsiclava*, 313  
*allognoto*, *Proserpina*, 25  
*alsidii*, *Goniotrichum*, 135  
*alta*, *Hamea*, 401  
*Amblema*, 219, 226, 227, 229, 233, 234, 239–241  
*Amblemidae*, 218, 234, 236, 238, 246, 249, 250, 253  
*Ambleminae*, 217, 231–239, 241–246, 249–253  
*Amblemini*, 217, 232, 234, 236–242, 246, 247, 250–253  
*amyra*, *Doto*, 441, 443, 447  
*Anadara*, 55  
*anapetes*, *Latirus*, 311, 313, 325, 326  
*anceps*, *Helisoma*, 262, 263  
*anceyi*, *Brazzaea*, 246  
*Ancilla*, 311–313, 326–328, 346  
*Ancula*, 441, 442, 445, 446, 448  
*angulata*, *Gonidea*, 219, 252  
*angulata*, *Vesicomya*, 187  
*angulatus*, *Latirus*, 313, 346  
*angulifera*, *Littorina*, 346  
*anguliferus*, *Murex*, 414  
*angustior*, *Littorina*, 346  
*Anisomyaria*, 224  
*Anodonta*, 206, 219, 221, 224–226, 233–238, 243–245, 251, 252, 263  
*Anodontinae*, 217, 231, 233–239, 242–246, 249, 250–253  
*Anomalodesmata*, 267–289  
*Anomia*, 143–150, 407  
*Anomiacea*, 143, 144, 147–149  
“*Anomiadae*,” 143  
*Anomiidae*, 143–151, 454  
*Ansates*, 292  
*Anthozoa*, 440, 442, 444, 445, 448  
*antillarum*, *Diadema*, 390, 392, 394–399  
*Antillophos*, 311, 323–325, 346  
*Antiopella*, 441–443, 445  
*anus*, *Distorsio*, 157  
*Aphera*, 307, 311, 332, 333  
*apiculata*, *Quadrula*, 219, 241, 250  
*Aplacophora*, 359, 361–383  
*aquatile*, *Cymatium*, 346  
*Araphidineae*, 136  
*aratus*, *Polinices*, 456, 458, 461, 462  
*Arbacia*, 390  
*Archaeogastropoda*, 1–33, 302  
*\*Archecharax*, 17, 18, \*20–24  
*Archidoris*, 114  
*Architectonica*, 346  
*Architectonicidae*, 346, 454  
*Archivesica*, 186, 187  
*Archosargus*, 135  
*Arcidae*, 454  
*Arctica*, 163, 183  
*Arcticidae*, 162, 163, 189  
*arcula*, *Alasmidonta*, 243  
*arenaria*, *Mya*, 224, 225, 417  
*arenarius*, *Murex*, 405  
*arenosa*, *Lyonsia*, 272  
*Argobuccinum*, 385, 388, 389, 392, 396, 400  
*argus*, *Argobuccinum*, 388, 389, 392, 396, 400  
*Armina*, 441, 444–446  
*Arminacea*, 440, 444  
*Arminidae*, 441  
*Arthropoda*, 455  
*Asciacea*, 439–449  
*asianus*, *Chicoreus*, 158, 160  
*Assimineidae*, 137  
*Astarte*, 182  
*Asteroidea*, 459  
*athearni*, *Goniobasis*, 64–68, 70–72, 75, 76  
*atlantica*, *Callocardia*, 162  
*atra*, *Polycera*, 441–442  
*atractus*, *Conus*, 313  
*atratum*, *Cerithium*, 121, 138, 346  
*Aturia*, 455  
*aurantia*, *Trinchesia*, 114

- aurantius*, *Conus*, 334  
*auricula*, *Crucibulum*, 316, 346  
*auricularia*, *Lymnaea*, 263  
*auritula*, *Pisania*, 346  
*australasiae*, *Monoplex*, 400  
*australis*, *Anomia*, 143  
*australis*, *Patro*, 143–146, 149, 150  
*Australorbis*, 263  
*axicornis*, *Chicoreus*, 159  
*Azotobacter*, 263  
Bacillariophyceae, 136  
*balteata*, *Ancilla*, 328  
*bandera*, *Persicula*, 333  
*banksi*, *Turritella*, 315  
*barbarensis*, *Antiopella*, 441–443, 445  
*barretti*, *Pleurotoma*, 337  
*barretti*, *Polystira*, 311, 314, 315, 335, 337, 338, 347  
*barretti*, *Turris*, 337  
Basommatophora, 256  
*Batillaria*, 124, 127, 137, 138  
*beana*, *Entodesma*, 268, 272–274  
*beau*, *Lyria*, 313  
*beaumonti*, *Cumanotus*, 441, 443  
*Bedeve*, 404, 405, 417  
*belcheri*, *Forreria*, 158  
*Belosepia*, 455  
*berendti*, *Proserpinella*, 23, 24  
*berjadinensis*, *Turritella*, 315  
Beryciformis, 455  
*bidentata*, *Despoenella*, 26, 29  
*bidentata*, *Proserpina*, 26, 28, 29  
*bilabiata*, *Eurystomella*, 445  
*bilamellata*, *Onchidoris*, 440–442, 444  
*bilix*, *Sinum*, 259  
*bimaculata*, *Venericardia*, 35, 41, 42, 52, 54  
*Biomphalaria*, 202  
*Biplex*, 153, 158  
Biraphidineae, 136  
*bisperforatus*, *Echinodiscus*, 391  
*bisulcatum*, *Phalium*, 391  
Bithyniidae, 137  
*Bittium*, 127, 135, 137–139  
*Bivalvia*, 39, 48, 205–252, 267–289, 359, 403, 454, . 455, 458, 459, 464–466  
*blakeana*, *Conomitra*, 330  
*blandiana*, *Cyane*, 20, 21  
*blandianus*, *Archecharax*, 21–23  
*bonairensis*, *Pagurus*, 135  
*Bonellitia*, 345, 461, 462, 464, 465  
*Borsonia*, 341  
Borsoninae, 340, 428, 431, 433–436  
*Bougainvillia*, 447  
*bowdenensis*, *Strioterebrum*, 311, 335, 336  
*bowdenensis*, *Terebra*, 336  
*Brazzaea*, 246  
*brevifrons*, *Chicoreus*, 346  
*brevifrons*, *Murex*, 404  
*Brissus*, 391  
*bronni*, *Thais*, 417  
*brunnea*, *Acanthodoris*, 444  
*brunneopicta*, *Truncaria*, 325  
*Bryozoa*, 439–449, 454, 459, 465  
Buccinidae, 307, 311, 323, 346, 454, 462, 466  
*Buccinum*, 206, 415  
*Buccitriton*, 457, 461–464  
*buckleyi*, *Elliptio*, 219, 221, 226, 227, 229, 250  
*buckleyi*, *Popenaias*, 234, 236  
*bufo*, *Bursa*, 346  
*Bullata*, 241  
*Bursa*, 153, 346, 385, 388, 396  
Bursidae, 153, 385, 389, 400  
*Busycon*, 415  
*caboblanquensis*, *Conus*, 313  
*caboblanquensis*, *Fusinus*, 311, 313, 325, 327  
*caboblanquensis*, *Strombina*, 311, 313, 323, 324  
*cactoides*, *Caulerpa*, 36  
Caecidae, 454  
Caenogastropoda, 307–347  
*californica*, *Armina*, 441, 444–446  
*californica*, *Cerithidea*, 137  
*californica*, *Lyonsia*, 268–272, 274–283  
*californicum*, *Prochaetoderma*, 373  
*Calliclava*, 424, 432, 435  
*Callinectes*, 135  
*Callocardia*, 162, 187  
*Callogonia*, 182, 187  
*Callothrix*, 135  
*Calotrophon*, 312, 313, 322, 346  
*Calybium*, 25  
*Calyptogena*, 161–194  
*Calyptraea*, 346  
*calyptraeformis*, *Sigapatella*, 41, 43, 57  
Calyptraeidae, 307, 311, 315, 346  
*Camplyodiscus*, 136  
*canadense*, *Chaetoderma*, 363  
*canaliculata*, *Thais*, 404  
*canaliculatum*, *Busycon*, 415  
*Cancellaria*, 333, 347  
Cancellariidae, 307, 311, 333, 347, 454, 462  
*candei*, *Antillophos*, 323, 325, 346  
*candidus*, *Modulus*, 117, 139  
*cantaurana*, *Paraborsonia*, 341  
*capensis*, *Gunnarea*, 400  
Capulidae, 403  
*Capulus*, 404  
*carchedonius*, *Modulus*, 118, 140  
Cardiacea, 233  
Cardiidae, 233  
*Cardita*, 163  
Carditidae, 162, 163, 183, 455, 458  
*Cardium*, 208, 414  
*caribaeorum*, *Cassidulus*, 390, 391, 395, 397, 399  
*caribbea*, *Vesicyoma*, 187  
*caribbeana*, *Conomitra*, 311, 329–331  
*carinata*, *Actinonaias*, 219, 229  
*carinata*, *Neomenia*, 361  
*Carocolla*, 17  
*cartagenensis*, *Turritella*, 315  
*Carunculina*, 219, 229, 234, 239  
Cassidae, 153, 307, 309, 311, 319, 346, 385–402  
*Cassidaria*, 321, 385, 388  
*Cassidulus*, 390, 391, 395, 397, 399  
*catalinae*, *Triopha*, 441, 442, 446–448  
*cataracta*, *Anodonta*, 219, 221, 224, 226  
*cataracta*, *Pyganodon*, 234

- catena*, *Natica*, 405  
*caudata*, *Eupleura*, 158, 404, 407, 408, 410, 411, 417  
*caudatus*, *Falcidens*, 362, 363, 365, 373, 375, 376  
*Caudofoveata*, 361, 378  
*Caulerpa*, 36  
*cedonulli*, *Conus*, 310, 313, 333, 334  
*Cellana*, 292, 300, 354  
*cellulosus*, *Murex*, 404, 405  
*Cenodagreutes*, 434  
Centrales, 136  
*centralis*, *Calyptraea*, 346  
*Cepaea*, 201  
Cephalopoda, 35, 39, 48, 359, 403, 455, 459  
*cepio*, *Pododesmus*, 143, 147, 148  
*Cerastoderma*, 286  
“*Ceratodiscinae*,” 13  
*Ceratodiscus*, 13  
*Ceratostoma*, 158  
*Cerberilla*, 441–445  
*Ceres*, 1–3, 4, 6–8, 12, 13, 16, 17  
\**Ceresidae*, 1, 12, \*13, 15, 16, 20  
*Ceriantharia*, 442, 444  
*Cerion*, 83  
Cerithiacea, 117, 142  
*Cerithidea*, 137  
*Cerithiidae*, 117, 136–138, 346  
*Cerithiinae*, 137  
*Cerithiopsis*, 138, 139  
*Cerithium*, 121, 124, 127, 131, 135, 137–139, 346  
*Chaetoderma*, 361–365, 367, 372, 373, 375, 376, 378, 380, 381  
*Chaetodermatidae*, 361, 363, 367, 372, 376, 380  
*Chaetodermomorpha*, 361–363, 367, 373, 375, 376, 378, 380  
*challengeri*, *Metachaetoderma*, 363, 373  
*Charonia*, 388, 392, 394, 396, 400  
*chazaliei*, *Hindsiclava*, 312, 338, 339, 347  
*Chersodespoena*, 19  
*Chicoreus*, 158, 159, 456  
*chilensis*, *Entodesma*, 268, 272–275, 285  
*chilensis*, *Pyura*, 268  
*chitanii*, *Adulomya*, 164, 185  
*chitanii*, *Akebiconcha*, 185  
*chitanii*, *Calyptogena*, 185  
*Chlorella*, 99–102, 106–112, 114, 115  
Chlorophyta, 135  
Chordata, 455  
*chromosoma*, *Spurilla*, 441–445  
*chuni*, *Vesicomya*, 187  
*cineraria*, *Gibbula*, 354, 355  
*cinerea*, *Cypraea*, 346  
*cinerea*, *Urosalpinx*, 285, 400, 404, 405, 407–415, 417  
*cinnamomea*, *Chersodespoena*, 19  
*cinnamomea*, *Despoena*, 19  
*cinnamomea*, *Linidiella*, 20  
*circinata*, *Aforia*, 425  
*Cirripedia*, 441, 459  
*Cladophora*, 135  
*claibornensis*, *Lampsilis*, 219  
*clathrata*, *Distorsio*, 346  
*Clathrodrillia*, 312, 313, 347  
*Clathromorphum*, 299  
*clathrus*, *Thalassiophylum*, 300  
Clathurellinae, 433–435  
*clavatus*, *Oreaster*, 391, 392  
*clavigera*, *Purpura*, 404  
Clavinae, 338, 424, 428, 432–436  
*Clavularia*, 445  
*clenchi*, *Goniobasis*, 65  
*closter*, *Fusinus*, 312, 313, 325, 346  
*Clypeaster*, 390, 397  
*Clypeomorus*, 137, 138  
Cnidaria, 376, 439–449  
*coarctata*, *Cypraecassis*, 391, 394  
*Cochlodesma*, 269, 286  
*cockerelli*, *Laila*, 441, 442  
Coelenterata, 454, 459  
*Collisella*, 292, 300, 301  
*colombiana*, *Subcancilla*, 330  
*Columbella*, 346  
Columbellidae, 307, 311, 323, 346  
*columbiana*, *Cuthona*, 441, 443, 447  
*commissuralis*, *Obelia*, 446, 447  
*complanata*, *Elliptio*, 219, 224, 250  
*complanata*, *Lasmigona*, 243  
*Compsodrillia*, 429  
*concentrica*, *Pronucula*, 35, 41, 43, 51–54  
*concinna*, *Cuthona*, 447  
Congridae, 455  
Conidae, 307, 309, 311, 334, 423, 428, 432–434, 436, 454, 458  
*Conomitra*, 307, 311, 329–331, 340  
*consobrinus*, *Conus*, 311, 313, 332–334  
*consors*, *Crassispira*, 338  
*consors*, *Hindsiclava*, 311, 335, 338  
*consors*, *Pleurotoma*, 338  
*consors*, *Turris*, 338  
*Conus*, 310–313, 332–334, 347, 434, 458  
*cooperi*, *Coryphella*, 441, 443, 447  
*coppingeri*, *lothia*, 300  
*Corambe*, 441, 442  
Corambidae, 441  
*Corbicula*, 205–216  
Corbulidae, 455, 461, 462  
*cordatum*, *Pleurobema*, 219  
*Cordia*, 341  
*corneum*, *Sphaerium*, 208, 209  
*corneus*, *Planorbarius*, 263  
*cornuta*, *Cassis*, 391, 392  
*coronatum*, *Thais*, 346  
*corpulenta*, *Anodonta*, 251  
*Coryphella*, 113, 441, 443, 445, 447  
Coryphellidae, 441  
Coscinodiscineae, 136  
*costata*, *Lasmigona*, 219, 226, 239  
*cousini*, *Archecharax*, 21, 23  
*cousini*, *Proserpinella*, 23  
*couvana*, *Oliva*, 328  
*crassicornis*, *Hermisenda*, 99–116  
*crassicornis*, *Phidiana*, 441, 443, 445, 447  
*crassidens*, *Elliptio*, 219, 250  
*Crassispira*, 338, 426, 433  
Crassispirinae, 425, 426, 433–435  
*Crepidula*, 135, 346, 407, 408

- Crinoidea, 459  
*crocea*, *Tubularia*, 446, 447  
*Crucibulum*, 311, 313–316, 346  
*crucicula*, *Mastogloia*, 136  
 Crustacea, 459, 464, 466  
*crustacea*, *Callothrix*, 135  
*Cryptobranchia*, 292  
*cryptus*, *Phascolion*, 135  
 Ctenostomata, 440  
*Cucullaea*, 187  
*Cumanotus*, 441, 443  
*Cumberlandia*, 219, 221, 225, 226, 234, 237  
 Cumberlandiinae, 234, 237, 250  
*Cuneameya*, 286  
*curvicostata*, *Goniobasis*, 64, 65, 67, 68, 70, 71, 76  
*Cuthona*, 113, 441, 443, 447  
 Cuthonidae, 441  
*Cyane*, 18, 20, 21, 23  
 Cyanophyta, 135  
 Cyclobranchia, 10  
*Cyclocardium*, 54  
*Cyclonaias*, 217, 219, 221, 225–227, 229, 234, 240, 241, 251  
*Cyclopecten*, 35, 41, 48, 55  
*cyclostomus*, *Echinoneus*, 391  
*cylindrica*, *Orthonymus*, 240, 241  
*cylindrica*, *Quadrula*, 219, 221, 225, 226, 229, 240, 241  
 Cymatiidae, 153, 346, 385, 386, 389, 400, 401, 454, 459  
*Cymatium*, 153, 156, 157, 160, 346, 385, 388, 394, 396, 399, 400  
*cymbaeformis*, *Crepidula*, 346  
*Cypraea*, 317, 319, 346  
*Cypraecassis*, 385, 391, 399  
 Cypraeidae, 307, 310, 311, 316, 346  
*Cyprina*, 183  
 Cyprinidae, 162, 163  
*Cyprogenia*, 242, 244  
*Cyrtonaias*, 241, 244  
*cytaeum*, *Anomia*, 147  
*dalli*, *Knefastia*, 426  
*danieli*, *Capulus*, 404  
 Daphnellinae, 429, 433–435  
*dariensis*, *Mitra*, 330  
*dariensis*, *Subcancilla*, 328, 330  
*daucus*, *Conus*, 347  
*deltoidalis*, *Tellina*, 35, 41, 43, 51, 52  
*deltoidea*, *Thais*, 346, 404  
*delumbis*, *Villosa*, 219, 221, 226, 250  
*demissa*, *Guekensia*, 224, 225  
*Dendraster*, 188  
 Dendronotacea, 439, 441, 442, 444, 445  
 Dendronotidae, 441  
*Dendronotus*, 441–445, 447, 448  
*dennisoni*, *Morum*, 313, 319, 320  
*Dentalium*, 267  
*dentatus*, *Trochus*, 354  
*depressa*, *Despoenella*, 25, 29  
*depressa*, *Odontostoma*, 25, 26  
*depressa*, *Proserpina*, 2, 8, 10, 25, 26, 28, 29  
*derbyi*, *Proserpina*, 17  
*derbyi*, *Staffola*, 17–19  
*Dermomurex*, 346  
*Despoena*, 19, 25  
*Despoenella*, 2, 10, 24–30  
*Diadema*, 390–392, 394–399  
 Dialidae, 136  
*Dicathais*, 409  
*dickinsoni*, *Goniobasis*, 64, 65, 67, 68, 70, 71, 74–78  
*didyma*, *Neverita*, 404  
*diemenensis*, *Notocallista*, 35, 41, 44, 52, 54  
 Digenae, 249, 251  
*Dimorphoptychia*, 16  
 Dimorphoptychinae, 16  
*Dimya*, 149  
 Dimyacea, 149  
 Dimyidae, 149  
*diomedia*, *Tritonia*, 441, 444–446  
 Diotocardia, 10, 12  
 Diplodontidae, 455  
*Dipodomys*, 78  
*Dirona*, 441, 443, 445  
 Dironidae, 441  
*Dispotaea*, 315, 316  
*Distaplia*, 284  
*Distorsio*, 153, 157, 346  
*divae*, *Precuthona*, 441, 443  
*diversicolor*, *Dendronotus*, 441, 443  
*dombeyanus*, *Plectomerus*, 219, 227, 229  
*dominguense*, *Morum*, 311, 313–320  
*donaciformis*, *Mysella*, 35, 41, 44, 51, 52, 54, 55  
*Dondersia*, 381  
*donmoorei*, *Murex*, 312, 313, 346  
*donmoorei*, *Siphocypraea*, 312, 313, 317–319, 346  
 Doridacea, 439, 441  
*Doridella*, 100, 441, 442  
 Dotidae, 441  
*Doto*, 441, 443, 447  
*Dromus*, 242, 244  
*Drosophila*, 72–74, 76, 77, 84  
*Drupa*, 416, 418  
*Dunaliella*, 100–102, 106–112, 114  
*duplicata*, *Compsodrillia*, 429  
*duplicatus*, *Polinices*, 404, 406–408, 410  
*ebena*, *Fusconaia*, 219, 227, 229, 250  
*Eburna*, 327  
*eburneum*, *Cerithium*, 346  
 Echinodermata, 455, 459  
*Echinodiscus*, 391  
*Echinometra*, 390–392, 394–399  
*Echinoneus*, 390, 391  
*echinophora*, *Cassidaria*, 388  
*echinophora*, *Galeodea*, 388, 389, 392, 396, 399, 400  
*echo*, *Cymatium*, 156  
*Ectenagena*, 162–165, 179, 185–187, 189  
*ecuadorensis*, *Crucibulum*, 315  
*edmitchelli*, *Collisella*, 300  
*edule*, *Cardium*, 208  
*edulis*, *Mytilus*, 54, 206, 213, 214, 407, 413  
 Elasmobranchii, 455  
*elegans*, *Antillophos*, 311, 323–325  
*elegans*, *Haminoea*, 135  
*elegans*, *Oenopota*, 434



- elegans*, *Okadaia*, 404  
*elegans*, *Phos*, 323  
*elegans*, *Tritiaria*, 323  
*eleutheria*, *Strioterebrum*, 337  
*ellipsis*, *Aphera*, 333  
*ellipsis*, *Cancellaria*, 333  
*Elliptio*, 217–219, 221, 224–227, 229, 234, 236–241, 250  
 Elliptionidae, 234, 249, 253  
 Elliptioninae, 234, 249  
 Elliptionini, 234, 240, 251  
*Elliptoideus*, 251  
*elodes*, *Lymnaea*, 210, 202  
*elongata*, *Akebiconcha kawamura*, 186  
*elongata*, *Calyptogena*, 161–165, 177, 179–181, 185–190  
*elongata*, *Ectenagena*, 164, 179, 186  
*elyros*, *Patro*, 143  
*emarginata*, *Nucella*, 404  
*Enigmonia*, 143, 144, 147–149  
*Ensis*, 54, 206, 286  
*Enteromorpha*, 135  
 Enteropneusta, 459  
*Entodesma*, 267–289  
 Entoprocta, 441, 442, 445  
*eolina*, *Carocolla*, 17  
*eolina*, *Ceres*, 17  
*eolina*, *Proserpina*, 17  
*eolinum*, *Odontostoma*, 17  
*ephippium*, *Anomia*, 143, 147–149  
*Epimania*, 361  
 Epitoniidae, 346, 454  
*Epitonium*, 346  
*epomis*, *Agatrix*, 311–313, 332, 333  
*epomis*, *Tribia*, 333  
*erinacea*, *Ocenebra*, 404, 405, 414, 415, 417  
 Eschatigenae, 242  
*esculentus*, *Tripneustes*, 394  
*etterae*, *Eupleura caudata*, 404  
 Eubbranchidae, 441  
*Eubbranchus*, 114, 441, 443, 447  
*Eucidaris*, 391, 392  
*Eudistoma*, 268, 270  
 Eulimidae, 454  
*Euparypha*, 195  
*Eupleura*, 158, 404, 407, 408, 410, 411, 417  
*Eurystomella*, 445  
*exiguus*, *Eubbranchus*, 114  
*exoleta*, *Turritella*, 346  
*ezoensis*, *Tapes*, 162  
 Facelinidae, 441  
*falcata*, *Margaritifera*, 219, 221, 237  
*Falcidens*, 361–363, 365, 372, 373, 376, 378, 380, 381  
*Fasciolaria*, 313, 345, 414  
 Fascioliariidae, 307, 311, 325, 346, 454, 462, 466  
 Fascioliariinae, 325  
*favus*, *Cyclopecten*, 35, 41, 48  
*femorale*, *Cymatium*, 157  
*Ferrissia*, 255, 266  
*festiva*, *Tritonia*, 441, 444–446  
*Festuca*, 263  
 Ficidae, 307, 311, 322, 385, 400, 454  
*Ficus*, 311, 312, 319  
*fidicula*, *Oenopota*, 430  
*filiformis*, *Syringodium*, 134  
*fimbriatus*, *Pachycerianthus*, 444, 448  
*Fiona*, 441, 443  
 Fionidae, 441  
 Fissurellidae, 354  
*flabellata*, *Lyonsia*, 272  
*flammea*, *Cassis*, 154, 386, 393, 394, 396–398  
*flava*, *Fusconaia*, 219, 221, 227, 229, 250  
*flava*, *Littorina*, 346  
*floridana*, *Lyonsia*, 267–289  
*floridana*, *Thais*, 404, 415  
*floridensis*, *Goniobasis*, 63–68, 70, 71, 73, 74–81  
*florifer*, *Chicoreus*, 158, 159  
*florifer*, *Murex*, 404, 405  
*fluminea*, *Corbicula*, 205–216  
*foliata*, *Pterorytis*, 404  
*foliatum*, *Ceratostoma*, 158  
*follyensis*, *Urosalpinx cinerea*, 400, 404, 405, 412  
 Foraminifera, 376, 455, 459  
*fornicata*, *Crepidula*, 135, 407, 408  
*Forreria*, 158  
 Fragilariacea, 136  
*fragile*, *Periploma*, 268  
*fragilis*, *Leptodea*, 219, 250  
*francesae*, *Strombina*, 323  
*francisensis*, *Micromytilus*, 35, 41, 42  
*fratula*, *Limifossor*, 363, 373, 375  
*frenchiensis*, *Lepton*, 35, 41, 43, 44, 48, 51, 52, 55  
*fretalis*, *Entodesma*, 268, 273, 277, 285  
*Friersonia*, 241, 244  
*frondosus*, *Dendronotus*, 441, 443, 445, 447, 448  
*fulgens*, *Cuthona*, 447  
*fulgurator*, *Oliva*, 328  
*fulvescens*, *Murex*, 405, 415  
*funiculata*, *Subcancilla*, 330  
*furcigera*, *Sphacelaria*, 135  
*fusca*, *Coryphella*, 447  
*Fusconaia*, 217, 218, 221, 225–227, 229, 234, 239–241, 250, 251  
*fuscus*, *Laevapax*, 255, 257, 262, 263  
*fusiformis*, *Owenia*, 431  
 Fusininae, 325  
*Fusinus*, 311–313, 325–327, 346  
*Fusitriton*, 396  
*Fusiturricula*, 310–313, 333, 338–340  
*galbana*, *Isochrysis*, 100, 101, 106, 107, 269, 270  
*galea*, *Tonna*, 346, 388, 389, 400  
*Galeodea*, 385, 388, 389, 392, 396, 399, 400  
 Gastropoda, 10, 11, 35, 39, 48, 99–116, 153–160, 195–204, 206, 302, 349–357, 359, 403–422, 451–469  
*gatumensis*, *Panamurex*, 311, 319, 322  
*gatumensis*, *Paziella*, 322  
*gatumensis*, *Phyllonotus*, 322  
*gatumensis*, *Strioterebrum*, 311, 335, 336  
*gatumensis*, *Terebra*, 336  
*Genitoconia*, 367, 380  
*Genkaimurex*, 407  
*Geukensia*, 224, 225  
*gibbera*, *Calyptogena*, 186, 189  
*gibbosa*, *Clathrodrillia*, 312, 313, 347

- Gibbula*, 354, 355  
*gigantea*, *Megaloniais*, 219, 221, 225–227, 229, 251  
*gigantea*, *Pleuroploca*, 414  
*gigas*, *Archivesica*, 187  
*gigas*, *Callocardia*, 187  
*gigas*, *Strombus*, 346  
*glabra*, *Anomia*, 147  
*glabrata*, *Ancilla*, 312, 328, 346  
*glabrata*, *Biomphalaria*, 202  
*glabratus*, *Australorbis*, 263  
*\*glaeserius*, *Archecharax*, 21–\*23, 24  
*glans*, *Prunum*, 312, 347  
*glaucum*, *Strioterebrum*, 336  
*Glebula*, 219, 227, 229, 234, 242  
*globulosa*, *Odontostoma*, 25  
*globulosa*, *Proserpina*, 25, 28  
*Glossus*, 182  
*Gomphina*, 35, 41, 42, 44, 52  
*Gonidea*, 217, 219, 228, 229, 234, 237–239, 241, 252, 253  
*Gonideinae*, 234, 237, 238, 246, 249, 250, 252  
*Gonideini*, 217, 234, 236–238, 246, 247, 250, 251  
*Goniobasis*, 63–81, 83–98  
*Goniotrichum*, 135  
*gonostoma*, *Turritella*, 315  
*Gorgonacea*, 445, 448  
*gouldiana*, *Pandora*, 268  
*gouldii*, *Lyonsia*, 268, 272, 275, 278  
*Gourmya*, 138  
*grandis*, *Plagiobrissus*, 390, 394, 397  
*granularis*, *Bursa*, 388  
*granulatum*, *Phalium*, 346, 391, 392, 394–397  
*guadalupensis*, *Pallacera*, 346  
*gualtieriana*, *Natica*, 407, 409  
*Gunnarea*, 400  
*Gymnobela*, 429  
*Gymnomenia*, 362–365, 367, 368, 370, 373, 376, 378, 380  
*gyrina*, *Physa*, 255, 256, 262, 263  
*haemastoma*, *Thais*, 404, 408, 409, 411, 415, 417, 418  
*Halodule*, 118, 132, 134  
*Hamea*, 401  
*Haminoea*, 135  
*hanleyi*, *Bedevea*, 404, 405, 417  
*hannae*, *Proserpinella*, 24  
*hartmani*, *Falcidens*, 363, 376  
*Hastula*, 347, 434  
*hedgpethi*, *Polycera*, 441, 442  
*Helcion*, 292  
*Helicina*, 6, 14, 25, 26  
*\*Helicinacea*, 1, 2, \*11–13, 16  
*Helicinidae*, 1, 2, 5, 6, 11–16  
*Helicininae*, 13, 14  
*Helisoma*, 257, 262, 263  
*hembeli*, *Margaritifera*, 219, 221, 226, 237  
*Hendersonia*, 12, 14, 16  
*Hendersoniinae*, 12–15  
*henekeni*, *Cypraea*, 317, 319  
*henekeni*, *Mitra*, 328  
*henekeni*, *Muracypraea*, 317  
*henekeni*, *Siphocypraea*, 311–313, 316–319, 341  
*henekeni*, *Subcancilla*, 330  
*henekeni*, *Tiara*, 328  
*henslowanum*, *Pisidium*, 209  
*hepaticum*, *Cymatium*, 157  
*hepaticus*, *Polinices*, 346  
*Hermisenda*, 99–116  
*heros*, *Lunatia*, 404, 408, 410, 417  
*Hesperiturreis*, 457, 462, 464, 465  
*Heteranomia*, 143, 145, 147, 149  
*heterodon*, *Alasmidonta*, 243  
*heterodon*, *Prolasmidonta*, 243  
*Heterodonta*, 224  
*Heterogenae*, 242, 244–246, 249, 251  
*Heterozostera*, 36  
*Hexacorallia*, 440  
*hiltoni*, *Phidiana*, 441, 443  
*Hindsiclava*, 335, 338, 339, 347, 427, 433–435  
*hodsoni*, *Persicula*, 311, 313, 331–333  
*hodsoni*, *Rabicea*, 331  
*hollisteri*, *Faciolaria*, 313  
*Holothuroidea*, 459  
*Homogenae*, 249, 251, 252  
*Hopkinsia*, 441, 442, 445, 446, 448  
*Hubertschenckia*, 162, 164  
*hudsoni*, *Acanthodoris*, 444  
*humerosa*, *Fusiturricula*, 311, 339, 340  
*humerosa*, *Surcula*, 340  
*humerosa*, *Turris*, 340  
*hyalina*, *Lyonsia*, 268, 270, 275, 276, 281  
*hydiana*, *Lampsilis*, 219, 242  
*Hydrobia*, 458  
*Hydrobiidae*, 137  
*Hydrocenacea*, 1, 11  
*Hydrocenidae*, 1, 11  
*Hydrozoa*, 440, 443, 446–448  
*Hyriidae*, 245  
*hystricina*, *Onchidoris*, 440, 442, 444  
*icterina*, *Elliptio*, 219, 224, 229  
*illacidata*, *Mitra*, 328  
*illacidata*, *Subcancilla*, 311, 328, 329  
*illacidata*, *Tiara*, 328  
*Imaclava*, 428, 432, 433, 435  
*imbecillis*, *Anodonta*, 219, 226, 243  
*implicata*, *Anodonta*, 219, 226  
*inaequivalvis*, *Pandora*, 268  
*inermis*, *Ophiodermella*, 431  
*infucata*, *Quincuncina*, 219, 226, 241, 250  
*infundibulum*, *Latirus*, 346  
*inornata*, *Ocenebra*, 404, 417  
*instabilis*, *Collisella*, 300  
*integra*, *Physa*, 263  
*interlineatus*, *Dendraster*, 188  
*intermedia*, *Conomitra*, 330  
*interruptolineata*, *Persicula*, 313, 331–333, 347  
*iodinea*, *Coryphella*, 441, 443, 445  
*iole*, *Fusiturricula*, 311, 339, 340  
*lothia*, 300  
*iris*, *Dendronotus*, 441, 442, 444, 445, 447, 448  
*iris*, *Villosa*, 219  
*ischna*, *Strioterebrum*, 311, 312, 335, 336  
*ischna*, *Terebra*, 336  
*islaecolonis*, *Aphera*, 311, 332, 333  
*islaecolonis*, *Cancellaria*, 333

- islandica*, *Arctica*, 163  
*Isochrysis*, 100, 101, 106, 107, 114, 269, 270  
*jacksonensis*, *Nanomactra*, 57  
*japonica*, *Ocenebra*, 404, 417  
*jaquensis*, *Fusiturricula*, 311–313, 333, 339, 340  
*jaquensis*, *Knefastia*, 340  
*jaquensis*, *Pleurotoma*, 340  
*jaspideus*, *Conus*, 313  
*julietta*, *Oliva*, 328  
*Katelsysia*, 35, 41, 43, 44, 51–55  
*Katherinella*, 458  
*kawamurai*, *Akebiconcha*, 162, 163, 186, 189  
*kawamurai*, *Calyptogena*, 188, 190  
*Kelliella*, 162, 183  
*Kelliellidae*, 162  
*kellogii*, *Retusa*, 457, 462  
*Kellyellidae*, 162, 182  
*kennicottii*, *Suavodrillia*, 431  
*kilmeri*, *Archivesica*, 186  
*kilmeri*, *Calyptogena*, 161, 177, 180, 183, 186  
*Knefastia*, 313, 340, 426  
*krebsi*, *Cymatium*, 346  
*kugleri*, *Strioterebrum*, 335, 336  
*Kurtziella*, 429, 432, 433, 435  
*kya*, *Doto*, 441, 443  
*labiatum*, *Phalium*, 391, 392  
*lacrimula*, *Siphocypraea*, 317  
*lacteus*, *Polinices*, 346  
*laeta*, *Paraborsonia*, 341  
*Laevapex*, 255, 257, 262, 263  
*laevigata*, *Cassidaria*, 321  
*laevigata*, *Nitidella*, 346  
*laevigata*, *Sconsia*, 311–313, 319, 321  
*laevior*, *Conomitra*, 330  
*Laila*, 441, 442  
*Lamellariidae*, 432  
*Lamellidens*, 246  
*lamellosa*, *Nucella*, 404  
*lamellosum*, *Epitonium*, 346  
*Laminaria*, 299  
*Lampsilidae*, 249, 252  
*Lampsilinae*, 234, 237, 238, 240, 249–252  
*Lampsilini*, 217, 232, 234, 236–239, 241, 242, 244, 246, 247, 250–253  
*Lampsilis*, 205–208, 214, 219, 227–230, 232–234, 237–239, 241, 242, 244, 250, 252  
*lanceolata*, *Elliptio*, 219, 229, 241, 250  
*languilati*, *Unio*, 243  
*lapillus*, *Nucella*, 404–406, 408, 410–415  
*lasia*, *Calyptogena*, 187  
*lasia*, *Phreagena*, 162, 163, 187  
*Lasmigona*, 219, 226, 234, 239, 243  
*lassula*, *Agladrillia*, 311, 335, 338  
*Laternula*, 268, 286  
*Latirus*, 311, 313, 325, 326, 346, 456, 461–464, 466  
*lauta*, *Pisania*, 346  
*leeana*, *Vesicomya*, 187  
*lehneri*, *Conomitra*, 311, 329–331  
*leopardus*, *Conus*, 434  
*Lepeta*, 292  
*Lepetidae*, 291, 292  
*Lepidoptera*, 25  
*Leptodea*, 219, 229, 234, 245, 250  
*Lepton*, 35, 41, 43, 44, 48, 51, 52, 55  
*Leucozonia*, 346  
*lewisi*, *Lunatia*, 404  
*lewisi*, *Polinices*, 285, 412  
*Lexingtonia*, 218  
*libya*, *Tiariturrus*, 415  
*Ligumia*, 219, 229, 234, 242  
*limata*, *Lyria*, 311, 313, 329, 331  
*Limifossor*, 362–365, 367, 368, 370, 373, 375, 376, 378, 380, 381  
*Limifossoridae*, 362  
*lineata*, *Littorina*, 346  
*lineata*, *Monodonta*, 354, 355  
*linguifera*, *Helicina*, 25  
*linguifera*, *Proserpina*, 25  
*linguleta*, *Enteromorpha*, 135  
*Linidiella*, 2, 6, 16–20  
*Lissarca*, 35, 41, 42  
*littorea*, *Littorina*, 285  
*Littorina*, 124, 132, 285, 309, 346  
*Littorinidae*, 309, 346  
*longa*, *Subcancilla*, 330  
*longa*, *Vesicomya*, 187  
*Longenae*, 241, 244, 251  
*longissima*, *Calyptogena*, 187  
*longissima*, *Cucullaea*, 187  
*Lottia*, 292  
*Lottiidae*, 300, 302  
*Lucina*, 183  
*lucunter*, *Echinometra*, 390–392, 394–399  
*lunata*, *Mitrella*, 135  
*Lunatia*, 404, 408–410, 417  
*lutea*, *Acanthodoris*, 444  
*lutheri*, *Pavlova*, 100, 101, 106, 107  
*lutosum*, *Cerithium*, 138, 140  
*Lymnaea*, 201, 202, 255, 256, 262, 263  
*lyngbyaceus*, *Microcoleus*, 135  
*Lyonsia*, 267–289  
*Lyonsiella*, 286  
*Lyonsiidae*, 267–289  
*Lyria*, 311, 313, 329, 331  
*Lyriinae*, 331  
*Lytechinus*, 390, 391  
*macgintyi*, *Distorsio*, 346  
*macrochisma*, *Monia*, 147  
*Macoma*, 54, 392, 400, 458  
*macroptera*, *Pteropurpura*, 159, 160  
*Mactra*, 208  
*Mactridae*, 454  
*maculata*, *Triopha*, 441, 442, 446–448  
*madagascariensis*, *Cassis*, 390, 394, 396, 397  
*\*magnifica*, *Calyptogena*, 161, \*165, 167–169, 171, 172, 175, 177, 179–185  
*magnifica*, *Ectenagena*, 165, 179  
*maiquetiana*, *Turritella*, 315  
*Malleidae*, 233  
*Mangeliinae*, 428–430, 433–437  
*mappa*, *Conus*, 334, 347  
*marcanoi*, *Despoenella*, 26, 28  
*marcanoi*, *Proserpina*, 26, 28  
*Marchia*, 159  
*mareense*, *Crucibulum*, 311, 313–316  
*mareense*, *Dispotaea*, 315

- marensis*, *Fusinus*, 311, 313, 326, 327  
*margaritacea*, *Neotrigonia*, 35, 41, 43, 52, 54, 55, 57  
Margaritaninae, 237, 252  
*margaritensis*, *Phyllonotus*, 312, 346  
*Margaritifera*, 219, 221, 225, 226, 230, 231, 233–235, 237, 238, 241, 245, 247, 252  
*margaritifera*, *Margaritifera*, 219, 225, 226, 237  
Margaritiferidae, 225, 226, 234, 238, 249, 250  
Margaritiferinae, 217, 231, 234, 235, 237, 238, 241, 243–247, 249–252  
*marginalba*, *Morula*, 417  
*marginalis*, *Lamellidens*, 246  
*marginatum*, *Prunum*, 347  
Marginellidae, 307, 311, 331, 346, 454  
*mariae*, *Tellina*, 35, 41, 42, 44, 48, 51–55  
*marina*, *Zostera*, 100  
*masoni*, *Fusconaia*, 218, 219, 221, 225, 226  
*Mastogloia*, 136  
Mathildidae, 454  
*Mazatlaniana*, 312, 313, 346  
Megalonaiadinae, 234, 236, 250, 251  
*Megalonaias*, 206, 219, 221, 225–227, 229, 232, 234, 236, 238–241, 251  
*megaradulatus*, *Scutopus*, 362, 364, 365, 367–369, 373, 375, 376, 378  
*melanobranhia*, *Phestilla*, 100, 113  
*meleagris*, *Littorina*, 346  
*Mellita*, 390, 391, 394, 397  
*Melongena*, 346  
*melongena*, *Melongena*, 346  
Melongenidae, 346  
*Melosira*, 135, 136  
Melosiraceae, 136  
*Meoma*, 390, 394  
*mercatoria*, *Columbella*, 346  
*Mercenaria*, 224, 225, 267, 417  
*mercenaria*, *Mercenaria*, 224, 225, 267, 417  
Mesogastropoda, 10, 11, 63–81, 137, 385–402, 432  
Mesogena, 242, 249, 251  
*messorius*, *Murex*, 346  
*Metachaetoderma*, 363, 373  
*Michela*, 457, 461–465  
*Microcoleus*, 135  
*Micromytilus*, 35, 41, 42  
*Microvoluta*, 330  
*midensis*, *Strioterebrum*, 337  
*miliaris*, *Kelliella*, 183  
*militaris*, *Hindsiclava*, 427  
*minima*, *Batillaria*, 138  
*Mitra*, 328, 330, 341  
*Mitrella*, 135  
Mitridae, 307, 311, 328, 454  
Mitrolumninae, 428, 433–435  
*modioliforma*, *Calyptogena*, 161, 165, 177, 179, 187  
*modioliforma*, *Ectenagena*, 179, 187  
Modulidae, 117–142  
*Modulus*, 117–142  
*modulus*, *Modulus*, 117–142  
*Moira*, 390  
Mollusca, 35–62, 99, 154, 195–204, 302, 359, 380, 423, 458–460, 464–466  
*Monia*, 143, 147  
*moniliformis*, *Melosira*, 135, 136  
*Monochrysis*, 114  
*Monodonta*, 354, 355  
*monodonta*, *Cumberlandia*, 219, 221, 225, 226, 237  
Monoplacophora, 359  
*Monoplex*, 400  
Monotocardia, 10, 11  
*moorei*, *Latirus*, 456, 461, 462  
*moraiensis*, *Calyptogena*, 188  
*moraiensis*, *Unio*, 188, 189  
*Morula*, 417  
*Morum*, 311, 313, 319, 320, 392  
*moskalevi*, *Problacmaea*, 299  
*mosslandica*, *Cerberilla*, 441, 445  
*muelleri*, *Zostera*, 36  
*Muracypraea*, 317  
*Murex*, 153, 158–160, 312, 313, 346, 404, 405, 414, 415  
Muricacea, 403–422  
*muricata*, *Onchidoris*, 440–442, 444  
*muricatum*, *Vasum*, 346  
*muricatus*, *Tectarius*, 346  
Muricidae, 153, 158, 307, 309, 311, 322, 346, 385, 399, 414, 454, 459  
Muricinae, 322  
*Muricopsis*, 404, 405  
*mus*, *Siphocypraea*, 312, 314, 317–319, 346  
*muscarum*, *Cerithium*, 127, 131, 135, 139, 140  
*musica*, *Voluta*, 347  
Mutelacea, 245  
*Mya*, 206, 224, 225, 417  
Myacea, 224  
*Mysella*, 35, 41, 44, 51, 52, 54, 55  
Mytilacea, 224  
*Mytilimeria*, 267–289  
*Mytilus*, 54, 206, 213, 214, 407, 413  
*Myurella*, 434  
*Nacella*, 292  
*nana*, *Cuthona*, 113  
*nanaimoensis*, *Acanthodoris*, 441, 442, 444  
*Nanomactra*, 57  
*nassa*, *Leucozonia*, 346  
Nassariidae, 346, 454  
*Nassarius*, 206, 346  
*nasuta*, *Ligumia*, 219, 229, 242  
*Natica*, 311, 312, 314, 316, 404, 405, 407, 409, 459  
Naticacea, 403–422  
*Naticarius*, 316  
Naticidae, 307, 311, 316, 346, 385, 399, 454, 458, 459, 461, 462, 464–467  
*Navicula*, 135, 136  
Naviculacea, 136  
*neapolitana*, *Spurilla*, 113  
*nebulosa*, *Littorina*, 346  
*nelsoni*, *Ceres*, 2–4, 5–7, 17  
*nemoralis*, *Cepaea*, 201  
Neogastropoda, 10, 11, 206, 432  
*Neomenia*, 361  
Neomeniomorpha, 361, 362, 364, 373, 376, 378, 380, 381  
*Neotrigonia*, 35, 41, 43, 52, 54, 55, 57  
*nephele*, *Sconsia*, 312, 321

- Neritacea, 1, 11, 12  
 Neritidae, 11  
 Neritimorpha, 10–12  
*nesiotes*, *Lyonsia*, 272  
*Neverita*, 404  
*nicobaricum*, *Cymatium*, 394, 396, 399, 400  
*niloticus*, *Trochus*, 349–357  
*nipponica*, *Akebiconcha*, 188  
*nipponica*, *Calyptogena*, 186, 188–190  
*nitida*, *Lunatia*, 409, 410  
*nitida*, *Natica*, 405  
*nitida*, *Proserpina*, 2–4, 8–10, 25  
*Nitidella*, 346  
*nitidulum*, *Chaetoderma*, 362–365, 367, 372, 373, 375, 376  
*Nitzschia*, 135, 136  
 Nitzschiaceae, 136  
*nobilis*, *Architectonica*, 346  
*Nodilittorina*, 346  
*nodocarinatus*, *Hesperiturris*, 457, 462  
 Noetiidae, 454  
*norvegica*, *Lyonsia*, 272  
*Notoacmea*, 292, 300  
*Notocallista*, 35, 41, 44, 52, 54  
*Notocorbula*, 458, 461, 462  
*novaezelandiae*, *Sigapatella*, 55  
*Nucella*, 404–406, 408, 410–415  
*nucleus*, *Planaxis*, 346  
*Nucula*, 54  
 Nuculanidae, 454  
 Nukulidae, 454  
 Nudibranchia, 99–116, 439–449, 459  
*nuttalli*, *Mytilimeria*, 268, 270, 283, 284, 288  
*Obelia*, 446–448  
*Obliquaria*, 242, 244  
*oblonga*, *Oliva*, 312, 346  
*obscura*, *Doridella*, 100  
*occidentalis*, *Distaplia*, 284  
*Ocenebra*, 404, 405, 414, 415, 417  
*ochracea*, *Collisella*, 300  
*ochraceus*, *Unio*, 244  
 Octocorallia, 440, 444–446  
*Octopus*, 404, 459  
*Odontostoma*, 17, 25, 26  
*Oenopota*, 428, 430, 433–435  
*Okadaia*, 404  
 Okeniidae, 441  
*Oliva*, 311–313, 326, 328, 346  
*olivaceus*, *Eubbranchus*, 441, 443, 447  
*Olivella*, 312, 346  
*oliviae*, *Spurilla*, 441–445  
 Olividae, 307, 311, 327, 346, 454  
 Onchidorididae, 440, 441, 444  
*Onchidoris*, 440–442, 444  
*Oniscidia*, 319  
*oniscus*, *Morum*, 392  
 Ophididae, 455  
*Ophiodermella*, 431  
 Opisthobranchia, 10, 99, 111, 447, 459  
*optabilis*, *Conus*, 312, 347  
*orbigny*, *Archecharax*, 21, 23  
*orbigny*, *Cyane*, 232  
*ordi*, *Dipodomys*, 78  
*Oreaster*, 391, 392  
*oregonensis*, *Argobuccinum*, 396  
*oregonensis*, *Fusitriton*, 396  
*Orthonymus*, 219, 234, 240, 241  
*ostrearum*, *Muricopsis*, 404, 405  
 Ostreidae, 454  
*ovata*, *Lampsilis ventricosa*, 205–208, 219, 242  
*ovina*, *Festuca*, 263  
*Owenia*, 431  
*Pachycerianthus*, 444, 448  
*pacifica*, *Ancula*, 441, 442, 445, 446, 448  
*pacifica*, *Calyptogena*, 161–163, 165, 177, 179, 180, 183, 185–190  
*pacifica*, *Corambe*, 441, 442  
*Pagurus*, 135  
*Pallacera*, 346  
*pallida*, *Tenellia*, 113  
*palustris*, *Lymnaea*, 255, 256, 262, 263  
*panamensis*, *Calyptogena*, 189  
*Panamurex*, 307, 311, 319, 322, 340  
*Pandora*, 268, 286  
*papillosa*, *Aeolidia*, 99–116, 441–445  
*Paraborsonia*, 307, 311, 339–341  
*paraguanensis*, *Turritella*, 311–315  
*Paraterebra*, 347  
*parilis*, *Bonellitia*, 456, 462  
*parthenopeum*, *Cymatium*, 346  
*Partula*, 83  
*parva*, *Carunculina*, 219, 239  
*Parviturbo*, 313  
*patagonica*, *Entodesma*, 268, 275  
*Patella*, 292, 411  
 Patellacea, 291  
 Patellidae, 291, 292, 300, 303  
*Patelloida*, 292  
*Patina*, 292  
*Patro*, 143–150  
*patula*, *Purpura*, 346  
*pauperculus*, *Dermomurex*, 346  
*paulettae*, *Knefastia*, 340  
*Pavlova*, 100, 101, 106, 107  
*Paziella*, 322  
*Pecten*, 206, 208  
 Pectinibranchia, 10  
 Pectinidae, 233  
*Pectinodonta*, 292  
*pellucida*, *Gymnomenia*, 373  
*pellucidus*, *Marchia*, 159  
*pellucidus*, *Pterynotus*, 160  
 Pennales, 136  
 Pennatulacea, 445, 448  
*perca*, *Biplex*, 158  
*peregra*, *Lymnaea*, 255, 262, 263  
*Periploma*, 268, 286  
*perplexa*, *Olivella*, 312, 346  
*perplicata*, *Amblema*, 219, 227, 229  
*perrugata*, *Urosalpinx*, 404, 405  
*Persicula*, 311–313, 331–333, 347  
*perspectivum*, *Sinum*, 404  
*Pervicavia*, 434  
*petropolitana*, *Vokesula*, 458  
*Phacoides*, 182  
*Phaeodactylum*, 99, 100, 102, 106, 109–112, 114, 115  
 Phaeophyta, 135

- Phalium*, 153, 346, 391, 392, 394–397  
*Phascolion*, 135  
*phaseolina*, *Thracia*, 268  
*Phestilla*, 100, 113  
*Phidiana*, 441, 443, 445, 447  
*Pholadella*, 286  
 Pholadomyidae, 286  
*Phos*, 323  
*Phreagena*, 162, 163, 187  
*Phyllonotus*, 159, 160, 312, 322, 346  
*Physa*, 255, 256, 262, 263  
*picta*, *Dirona*, 441, 443, 445  
*picta*, *Polystira*, 425  
*pileare*, *Cymatium*, 346  
*pileolus*, *Toxopneustes*, 391  
*pileolus*, *Tripneustes*, 391  
*pilosa*, *Acanthodoris*, 441, 442, 444  
*pilsbryi*, *Ficus*, 311, 312, 319  
*Pinna*, 286  
*pinnata*, *Fiona*, 441, 443  
*pisana*, *Theba*, 195–204  
*Pisania*, 346  
*Pisidium*, 209  
*pisum*, *Proserpina*, 25, 28  
*Pitar*, 286  
*Placuna*, 143, 144, 147, 149  
*Placunanomia*, 143  
*Plagiobrissus*, 390, 394, 397  
*plana*, *Crepidula*, 346  
 Planaxidae, 346  
*Planaxis*, 346  
*planci*, *Acanthaster*, 391, 392  
*planiliratus*, *Conus*, 311, 313, 334, 335  
*\*planior*, *Despoenella*, \*29, 30  
*\*planior*, *Prosperina*, 27–\*29–31  
*Planorbarius*, 263  
*planulata*, *Proserpina*, 25  
*planum*, *Crucibulum*, 316  
*Plectomerus*, 219, 227, 229, 234, 239–241  
*Pleurobema*, 218, 219, 229, 234, 239, 240  
 Pleurobeminae, 234, 249, 250, 252  
 Pleurobemini, 217, 232, 234, 236–240, 242, 246, 247, 250–253  
 Pleuroceridae, 63–81, 83–98  
*Pleurofusua* 338  
*Pleurophopsis*, 162  
*Pleurophopsis*, 162–164  
*Pleurophoropsis*, 162  
*Pleurophosis*, 162  
*Pleuroploca*, 414  
*Pleurotoma*, 337, 338, 340  
*plicata*, *Amblema*, 219, 226, 227, 229  
*plumbea*, *Kurtziella*, 429  
*Pododesmus*, 143–149  
*Policordia*, 286  
*Polinices*, 285, 346, 404, 406–408, 410, 412, 456, 458, 461–466  
*Polycera*, 441, 442  
 Polyceridae, 441  
 Polychaeta, 459  
*Polygona*, 325  
 Polyplacophora, 35, 39, 48, 359  
*Polystira*, 311, 314, 315, 335, 337, 338, 347, 425  
*pomum*, *Murex*, 160, 404, 405  
*pomum*, *Phyllonotus*, 159  
*ponderosa*, *Calyptogena*, 165, 179, 189  
*popei*, *Popenaias*, 237  
 Popenaiadinae, 234, 236, 250  
*Popenaias*, 234, 236  
 Porifera, 439  
*Porolithon*, 349, 350, 352–354  
 Potamididae, 117, 136–138  
*praetenuae*, *Cochlodesma*, 268  
*Precuthona*, 441, 443  
*probatocephalus*, *Archosargus*, 135  
*Problacmaea*, 292, 299  
*Prochaetoderma*, 361–365, 367, 370–373, 375–378, 380, 381  
 Prochaetodermatidae, 363  
*Prolasmidonta*, 243  
*Pronucula*, 35, 41, 43, 51–54  
*Proptera*, 219, 221, 225–227, 229, 231, 234, 252  
 Propterinae, 249  
*Proserpina*, 1–4, 6, 8, 9, 10, 12, 13, 16–20, 24–31  
*Proserpinella*, 13, 17, 23, 24  
 Proserpinellinae, 13  
 Proserpinidae, 1–33  
 Proserpininae, 1  
*Proserpinus*, 25  
 Prosobranchia, 2, 10, 12, 83–98, 114, 117–142, 198  
 Protobranchia, 183  
*proxima*, *Goniobasis*, 83–98  
*Prunum*, 312, 347  
*prunum*, *Prunum*, 347  
*psammion*, *Eudistoma*, 268, 284  
*pseudoargus*, *Archidoris*, 114  
*Pseudodon*, 238  
 Pseudodontinae, 234, 238  
 Pseudomelatominae, 424, 425, 433–435  
*pseudonana*, *Thalassiosira*, 269, 270  
*Pseudovertagus*, 137, 138  
 Pteriacea, 233  
 Pteriidae, 233  
*Pteropurpura*, 159, 160  
*Pterorytis*, 404  
*Pterynotus*, 158, 160  
*Ptychobranchus*, 219, 227, 229, 234, 239, 242  
 Ptychogenae, 242, 249, 251  
*ptychostoma*, *Helicina*, 25, 26  
*pugetensis*, *Lyonsia*, 208, 271, 272, 275  
*pugilis*, *Strombus*, 346  
*pulchra*, *Proserpina*, 25  
*pulchrum*, *Prunum*, 312, 347  
 Pulmonata, 2, 10, 12, 195–204  
*pumilio*, *Strombina*, 312, 323, 324, 326  
*puncticulatus*, *Conus*, 313, 347  
*puntagordana*, *Tegula*, 313  
*Purpura*, 346, 404, 406  
*purpurata*, *Proptera*, 219  
*pustulosa*, *Quadrula*, 219, 229, 241, 251  
 Pycnogonida, 459  
*Pyganodon*, 234  
 Pyramidellidae, 454  
 Pyramimitridae, 454  
*Pyura*, 268

- quadrangularis*, *Samarangia*, 283  
*quadrispiralis*, *Strioterebrum*, 311, 313, 335, 337  
*quadrispiralis*, *Terebra*, 337  
*Quadrula*, 217, 219, 221, 225–227, 229, 234, 238–241, 250, 251  
*quadrula*, *Quadrula*, 219, 221, 225, 241, 251  
 Quadrulidae, 249, 252  
 Quadrulinae, 234, 249, 250  
*Quincuncina*, 219, 226, 234, 239–241, 250  
*quinqüesperforata*, *Mellita*, 390, 391, 394, 397  
*Rabicea*, 331  
*radiata*, *Lampsilis*, 219, 228, 229, 239, 242, 244  
*raduliferum*, *Prochaetoderma*, 370  
*ramosus*, *Chicoreus*, 159  
*raninus*, *Strombus*, 346  
*Rapana*, 404–406, 417  
*recta*, *Ligumia*, 219, 242  
*recticanalis*, *Latirus*, 313  
 Rectidentinae, 234, 249  
*recurvirostris*, *Murex*, 313  
*reflexa*, *Obliquaria*, 244  
*reticularis*, *Oliva*, 313  
*reticulata*, *Cancellaria*, 347  
*reticulata*, *Distorsio*, 157  
*Retusa*, 457, 461–466  
*Rhabdonema*, 136  
*rhadina*, *Mitra*, 330  
*rhadina*, *Subcancilla*, 311, 329, 330  
*Rhinoclavis*, 127, 131, 137, 138  
*rhodoceras*, *Acanthodoris*, 444  
*Rhodopetala*, 291–305  
 \*Rhodopetalinae, 291–\*302–305  
 Rhodophyta, 135  
*rhytiphora*, *Katelysia*, 35, 41, 43, 44, 51–55  
*ricina*, *Drupa*, 416, 418  
 Ringiculidae, 454  
*rivularis*, *Ferrissia*, 255–266  
*robustus*, *Scutopus*, 362, 368, 369, 373, 377  
*rosacea*, *Hopkinsia*, 441, 442, 445, 446, 448  
*rosaceus*, *Clypeaster*, 390, 397  
*rosea*, *Rhodopetala*, 291–305  
*rotundata*, *Glebula*, 219, 227  
*rubela*, *Tectura*, 295, 299, 301  
*rubicunda*, *Charonia*, 396  
*rubricata*, *Lissarca*, 35, 41, 42  
*rubrocincta*, *Proserpina*, 25, 26  
*rudis*, *Crassispira*, 426  
*rufa*, *Cypraecassis*, 391  
*rugosa*, *Cassidaria*, 385  
*rugulata*, *Oenopota*, 430  
*rustica*, *Thais*, 346  
*rustyus*, *Eubranchus*, 441, 443, 447  
*Saccorhiza*, 376  
 Sagdidae, 283  
*sagenum*, *Buccitriton*, 457, 462  
*salleana*, *Ceres*, 2, 6, 17  
*salleana*, *Hastula*, 347  
*salleana*, *Proserpina*, 17  
*Samarangia*, 283  
*sapidus*, *Callinectes*, 135  
 Saxicavacea, 180  
*saxicola*, *Entodesma*, 267, 289  
*scabra*, *Collisella*, 300  
*Scaphopoda*, 39, 359, 454, 458, 459, 464  
*schepmani*, *Oliva*, 311–313, 326, 328  
 Schizodonta, 224  
 Scianidae, 455  
 Scleractinia, 454  
*Scobinella*, 341  
*Sconsia*, 311–313, 319, 321  
*scripta*, *Oliva*, 346  
 \**scudderae*, *Despoenella*, \*26, 27, 30  
 \**scudderae*, *Proserpina*, \*26–28, 30, 31  
*Scurria*, 292  
 Scutibranchia, 10  
*Scutopus*, 361–365, 367–370, 373, 375–378, 380, 381  
 Semelidae, 455  
*semicarinata*, *Goniobasis*, 83–98  
*semigranosum*, *Phalium*, 391, 392  
*semilunata*, "Natica" (*Naticarius*), 459  
 Septariidae, 11  
 Serranidae, 455  
*setosum*, *Diadema*, 391, 392  
*severa*, *Natica*, 404  
*sibogae*, *Phestilla*, 113  
*Sigapatella*, 41, 43, 55, 57  
*simplex*, *Anomia*, 143, 147, 148, 407  
*simplex*, *Goniobasis*, 83–98  
*simplex*, *Oenopota*, 430  
*Simrothiella*, 381  
*Sinum*, 404, 459  
*Siphocypraea*, 310–314, 316–319, 341, 346  
*smithvillensis*, *Vokesula*, 462  
 Soleidae, 455  
*Solemya*, 164, 189  
 Solemyidae, 164  
*Solen*, 41, 42, 52–54, 57  
 Solenogastres, 361  
*solidissima*, *Spisula*, 417  
*soyoae*, *Akebiconcha*, 189  
*soyoae*, *Calyptogena*, 186, 188–190  
*Sphacelaria*, 135  
 Sphaeriacea, 205, 230  
 Sphaeriidae, 230  
*Sphaerium*, 208  
*spinosa*, *Cassis*, 391, 392  
*spirata*, *Acanthina*, 405, 408, 415  
*Spisula*, 417  
*splendida*, *Lampsilis*, 219  
 Spongillidae, 459  
*springvaleense*, *Crucibulum*, 311, 314, 316  
*springvaleense*, *Dispotaea*, 316  
*spurca*, *Cypraea*, 346  
*Spurilla*, 113, 441–445  
 Spurillidae, 441  
*spurius*, *Conus*, 347  
*squama*, *Monia*, 147  
*squamula*, *Anomia*, 149  
*squamula*, *Heteranomia*, 143, 147  
*Staffola*, 17–20  
*stagnalis*, *Lymnaea*, 263  
*stearnsi*, *Vesicomya*, 182, 183  
*steinbergae*, *Doridella*, 441, 442  
*stenopa*, *Natica*, 311, 312, 314, 316  
*stimpsoni*, *Conus*, 334

- Stoastoma*, 13  
 "Stoastomatidae," 13  
*Stolonifera*, 445, 448  
*striata*, *Sconsia*, 313, 321  
*striata*, *Vesicomya*, 182  
*Striatella*, 136  
 Strictispirinae, 425, 433–435  
*Strioterebrum*, 311–313, 335–337  
 Strombidae, 117, 137, 346  
*Strombina*, 309, 311–313, 323, 324, 346  
*Strombus*, 137, 346  
*Strophitus*, 245, 247  
 Stylommatophora, 195–204  
*suavis*, *Vesicomya*, 187  
*Suavodrillia*, 431  
*Subcancilla*, 311, 328–330  
*subdepressus*, *Clypeaster*, 390  
*subramosus*, *Dendronotus*, 441, 443  
*subrugosa*, *Collisella*, 301  
*subtentum*, *Ptychobranthus*, 219, 229, 239  
*subtruncata*, *Mactra*, 208  
 Subulitacea, 432  
*sulcata*, *Melosira*, 136  
*sulcidentata*, *Eupleura*, 404  
*sulfureous*, *Linidiella*, 19, 20  
*Surcula*, 340  
 Surellanceae, 136  
*swifti*, *Cyane*, 20  
*swifti*, *Linidiella*, 2, 6, 20  
*swifti*, *Proserpina*, 19, 20  
*sybaritica*, *Problacmaea*, 299  
*symmetricus*, *Conus*, 311, 334–336  
*Synedra*, 136  
*Syringodium*, 134  
*tabulata*, *Oenopota*, 430  
*Taenioglossa*, 432–434  
*Tagelus*, 286  
*takanosimensis*, *Aeolidiella*, 441–445  
*talpoideus*, *Limifossor*, 362, 364, 365, 367, 368, 373, 375  
*tampaensis*, *Urosalpinx*, 404, 405  
*tampicoensis*, *Cyrtoneias*, 244  
*tankervillei*, *Ancilla*, 312, 313, 327, 328, 346  
*Tapes*, 162  
*tasmanica*, *Heterozostera*, 36  
*taurina*, *Paraterebra*, 347  
*Tectarius*, 346  
*tectum*, *Modulus*, 117, 118, 137, 139  
*Tectura*, 292, 295, 299, 301  
 Tecturidae, 292, 302  
*Tegula*, 313  
*Tellina*, 35, 41–44, 48, 51–55, 286  
 Tellinidae, 454  
*Tenellia*, 113, 441, 443, 447  
*Terebra*, 336, 337, 434  
 Terebridae, 307, 311, 336, 347, 423, 434, 436, 454  
*teres*, *Lampsilis*, 219, 239, 241, 242  
*tertiolecta*, *Dunaliella*, 100–102, 106–112, 114  
*tessellata*, *Aphera*, 333  
*tessellata*, *Cassis*, 391, 392  
*tessellata*, *Littorina*, 346  
*tessellata*, *Persicula*, 312, 347  
*testiculus*, *Cypraecassis*, 385, 391–399  
*testudium*, *Thalassia*, 118, 134  
 Tetrageae, 249, 251  
*tetralasmus*, *Uniomerus*, 219, 250  
*tetraquetra*, *Tochuina*, 441, 444–446  
*texana*, *Notocorbula*, 458, 462  
 Thaididae, 309, 346  
*Thais*, 346, 404–406, 408, 409, 411, 415, 417, 418  
*Thalassia*, 118, 134, 319  
*Thalassiophylum*, 299, 300  
*Thalassiosira*, 269, 270  
*Theba*, 195–204  
*Theodoxus*, 12  
*thomasiana*, *Rapana*, 404–406, 417  
*Thracia*, 268, 286  
*Thyasira*, 180, 189  
*Tiara*, 328  
*Tiariturrus*, 425  
*Tochuina*, 441, 444–446  
*Tonna*, 346, 388, 389, 400  
 Tonnacea, 385–403  
 Tonnidae, 346, 385  
*Toxoglossa*, 423–438  
*Toxopneustes*, 390, 391  
*trabeatoides*, *Michela*, 457, 462  
*Trachycardium*, 286  
*tramoserica*, *Cellana*, 354  
*trapexia*, *Anadara*, 55  
*trialatus*, *Pterynotus*, 158  
*Tribia*, 333  
*tribuloides*, *Eucidaris*, 391, 392  
*tribulus*, *Murex*, 159  
*tricornutum*, *Phaeodactylum*, 99, 100, 102, 106, 109–112, 114, 115  
 Triculinae, 83  
 Tridacnidae, 233  
 Trigoniidae, 55  
*trilineata*, *Coryphella*, 441, 443, 447  
*Trinchesia*, 114  
*trinitatensis*, *Thais*, 346  
*Triopha*, 441, 442, 446–448  
 Triophidae, 441  
*Tripneustes*, 386, 390–398  
*triquetra*, *Eupleura*, 411  
*triseriata*, *Lunatia*, 404, 410  
*trispiralis*, *Strioterebrum*, 311, 313, 335, 337  
*trispiralis*, *Terebra*, 337  
*Tritiaria*, 323  
*Tritogonia*, 219, 227, 229, 234, 240, 241, 250  
*Tritonia*, 441, 444–446  
 Tritoniidae, 441  
*trivolvus*, *Helisoma*, 257  
 Trochidae, 349, 353  
*Trochus*, 349–357  
*troscheli*, *Murex*, 159  
*Truncaria*, 307, 311, 324, 325  
*truncata*, *Laternula*, 268, 286  
 Truncatellidae, 137  
*trunculus*, *Murex*, 415  
*tuberculata*, *Cycloneias*, 219, 221, 225, 226, 241, 257  
*tuberculata*, *Nodilittorina*, 346  
*tuberosa*, *Cassis*, 154, 155, 385, 386, 390, 392–394, 396–399



- Tubularia*, 446, 447  
*Tubulipora*, 442  
*tulipa*, *Fasciolaria*, 346, 414  
*tumidus*, *Unio*, 263  
*tumulosa*, *Thais*, 417  
*Tunicata*, 439, 440  
*Turbinellidae*, 346  
*Turbinidae*, 454  
*Turbinimorpha*, 10, 11, 13  
*turricula*, *Oenopota*, 430  
*Turriculinae*, 338, 425, 426, 433–435  
*Turridae*, 307, 311, 337, 423, 424, 432–437, 454, 462, 464–466  
*Turrinae*, 337, 425, 433–435  
*Turris*, 337, 338, 340  
*Turritella*, 126, 311–315, 346  
*Turritellidae*, 307, 311, 313, 346, 454  
*uchimuraensis*, *Adulomya*, 164  
*undatum*, *Buccinum*, 415  
*undatus*, *Conus*, 312, 347  
*undulata*, *Alasmidonta*, 219  
*undulosa*, *Gomphina*, 35, 41, 42, 44, 52  
*unicolor*, *Brissus*, 391  
*unimaculata*, *Imaclava*, 428  
*Unio*, 188, 189, 236, 243, 244, 253, 263  
*unioides*, *Pleurophopsis*, 162  
*Uniomereus*, 219, 229, 234, 240, 250  
*Unionacea*, 205, 217–252  
*Unionidae*, 217–253  
*Unioninae*, 234, 236–238, 249, 250, 252, 253  
*unipunctata*, *Striatella*, 136  
*Urosalpinx*, 285, 400, 404, 405, 407–415, 417  
*vaginoides*, *Solen*, 41, 42, 52–54, 57  
*valdiviae*, *Calyptogena*, 189, 190  
*valdiviae*, *Vesicomya*, 190  
*vanbrunti*, *Echinometra*, 391  
*vanhyningiana*, *Goniobasis*, 64, 65, 67, 68, 70, 71, 73, 75–78  
*varicosa*, *Borsonia*, 341  
*varicosa*, *Cordiera*, 341  
*varicosa*, *Genkaimurex*, 407  
*varicosa*, *Mitra*, 341  
*varicosa*, *Paraborsonia*, 339, 341  
*variegata*, *Charonia*, 392  
*variegata*, *Turritella*, 313–315, 346  
*variegatus*, *Lytechinus*, 390, 391  
*variegatus*, *Toxopneustes*, 390, 391  
*varium*, *Bittium*, 135  
*Vasum*, 346  
*Vayssiereidae*, 403  
*velero*, *Calotrophon*, 312, 313, 322, 346  
*Veneracea*, 224  
*Venericardia*, 35, 41, 42, 52, 54, 458  
*Veneridae*, 162, 455, 458  
*venezuelana*, *Ancilla*, 311–313, 326–328  
*venezuelana*, *Eburna*, 327  
*venezuelana*, *Mitra*, 330  
*venezuelana*, *Subcancilla*, 311, 329, 330  
*venezuelensis*, *Parviturbo*, 313  
*ventricosa*, *Lampsilis*, 205–208, 219  
*ventricosa*, *Meoma*, 390, 394  
*ventricosus*, *Tripneustes*, 396, 390–393, 395–398  
*ventrolineatus*, *Scutopus*, 373  
*Venus*, 54  
*Vermetidae*, 137  
*verreauxi*, *Olivella*, 346  
*verrucosa*, *Epimения*, 361  
*verrucosa*, *Tritogonia*, 219, 241, 250  
*Verticordiidae*, 268  
*Vesicomya*, 162, 164, 182, 183, 187, 190  
*Vesicomysidae*, 162, 164  
*Vesicomysidae*, 161–194  
*Viana*, 15  
*Vianinae*, 1, 10, 13–15  
*vibex*, *Nassarius*, 346  
*Villosa*, 219, 221, 225–227, 229, 234, 242, 250  
*viridis*, *Echinometra*, 391  
*Vitrinellidae*, 454  
*Vokesula*, 458, 461, 462  
*Voluta*, 309, 310, 347  
*Volutidae*, 307, 310, 311, 331, 346, 454  
*Volutomitridae*, 307, 311, 330  
*vulgaris*, *Octopus*, 404  
*vulgata*, *Patella*, 411  
*waccamawensis*, *Elliptio*, 219, 229  
*wahlametensis*, *Anodonta*, 219  
*waltonense*, *Crucibulum*, 315  
*Wilkingia*, 286  
*willistoni*, *Drosophila*, 72–74, 76, 77  
*winckworthi*, *Vesicomya*, 187  
*Wireniidae*, 362, 380  
*wrightii*, *Halodule*, 118, 134  
*yezoensis*, *Laminaria*, 299  
*zebra*, *Cypraea*, 346  
*Zephyrinidae*, 441  
*zeylanicum*, *Phalium*, 391  
*ziczac*, *Littorina*, 309, 346  
*Zonulispirinae*, 429, 433–435  
*Zostera*, 36, 100  
*zosteriae*, *Polycera*, 441, 442



page. Each table must be submitted double-spaced throughout on a separate manuscript page. Do not use vertical lines.

All **References** cited in the text must be listed (bibliographies including uncited items are unacceptable). Each reference should be cited accurately (the Editors will spot check for accuracy) and should be in the style used in recent issues of MALACOLOGIA—except that beginning with Vol. 16 journal titles will be cited complete and unabbreviated. For all manuscripts submitted henceforth, disregard the abbreviations in MALACOLOGIA, 1972, 11(2): 415–426. The journal uses the ampersand (&) for “and”; “et al.” may be used in the text, but not in the References. In addition to the volume number, complete page numbers of articles and books must be cited. If plates or maps, etc., are not included in the pagination they too must be cited. For books, the publisher and city are required. In systematic papers, synonymies should not give complete citations but should relate by author, date and page to the References.

**Voucher specimens.** In systematic papers, all new type-specimens must be deposited in museums where they may be consulted by other scientists. Beginning with Vol. 16 and when appropriate, MALACOLOGIA will also require that voucher specimens from other kinds of research be deposited in museums.

**Reprints.** When they order 50 or more reprints, authors will receive 25 additional reprints gratis; additional copies may be ordered at the time proof is returned to the Editorial Office. Later orders cannot be considered.

#### PAGE COSTS

MALACOLOGIA requests authors with grant support to help pay publication costs. MALACOLOGIA requires subsidization for extra long papers.

#### SUBSCRIPTION COSTS

For Vol. 21, personal subscriptions are U.S. \$17.00 and institutional subscriptions are U.S. \$27.00. For information on Vol. 22, address inquiries to the Subscription Office.

## CONTENTS

M. LAZARIDOU-DIMITRIADOU et J. DAGUZAN Etude de l'effet du "groupement" des individus chez <i>Theba pisana</i> (Mollusque Gastéropode Stylommatophore) .....	195
L. R. KRAEMER The osphradial complex of two freshwater bivalves: histological evaluation and functional context .....	205
G. M. DAVIS and S. L. H. FULLER Genetic relationships among Recent Unionacea (Bivalvia) of North America .....	217
W. D. RUSSELL-HUNTER, A. J. BURKY and R. D. HUNTER Interpopulation variation in calcareous and proteinaceous shell components in the stream limpet, <i>Ferrissia rivularis</i> .....	255
R. S. PREZANT The arenophilic radial mantle glands of the Lyonsiidae (Bivalvia: Anomalodesmata) with notes on lyonsiid evolution .....	267
D. R. LINDBERG Rhodopetalinae, a new subfamily of Acmaeidae from the boreal Pacific: anatomy and systematics .....	291
E. J. PETUCH A relict Neogene caenogastropod fauna from northern South America .....	307
G. A. HESLINGA Larval development, settlement and metamorphosis of the tropical gastropod <i>Trochus niloticus</i> .....	349
AMERICAN MALACOLOGICAL UNION SYMPOSIUM: FEEDING MECHANISMS OF PREDATORY MOLLUSCS Louisville, Kentucky. 24 July, 1980	
A. J. KOHN Introduction to the symposium .....	359
A. H. SCHELTEMA Comparative morphology of the radulae and alimentary tracts in the Aplacophora .....	361
R. N. HUGHES and H. P. I. HUGHES Morphological and behavioural aspects of feeding in the Cassidae (Tonacaea, Mesogastropoda) .....	385
M. R. CARRIKER Shell penetration and feeding by naticacean and muricacean gastropods: a synthesis .....	403
R. L. SHIMEK and A. J. KOHN Functional morphology and evolution of the toxoglossan radula .....	423
J. NYBAKKEN and G. McDONALD Feeding mechanisms of West American nudibranchs feeding on Bryozoa, Cnidaria and Ascidiacea, with special respect to the radula .....	439
R. J. STANTON, Jr., E. N. POWELL and P. C. NELSON The role of carnivorous gastropods in the trophic analysis of a fossil community .....	451
INDEX TO VOLUME 20, Nos. 1 and 2 .....	471







ACME  
BOOKBINDING CO., INC.

MAY 15 1984

100 CAMBRIDGE STREET  
CHARLESTOWN, MASS.





3 2044 072 160 443

